



DATA BOOK

INVERTER WALL MOUNTED TYPE RESIDENTIAL AIR-CONDITIONERS (Split system, air to air heat pump type)

DXK09Z6-S

DXK12Z6-S

DXK15Z6-S

CONTENTS

1. SPECIFICATIONS	2
2. EXTERIOR DIMENSIONS	6
(1) Indoor units	6
(2) Outdoor units	7
(3) Wireless remote control	9
3. ELECTRICAL WIRING	10
(1) Indoor units	10
(2) Outdoor units	11
4. NOISE LEVEL	12
5. PIPING SYSTEM	21
6. RANGE OF USAGE & LIMITATIONS	22
7. CAPACITY TABLES	24
8. APPLICATION DATA	25
9. TECHNICAL INFORMATION	33

■ How to read the model name

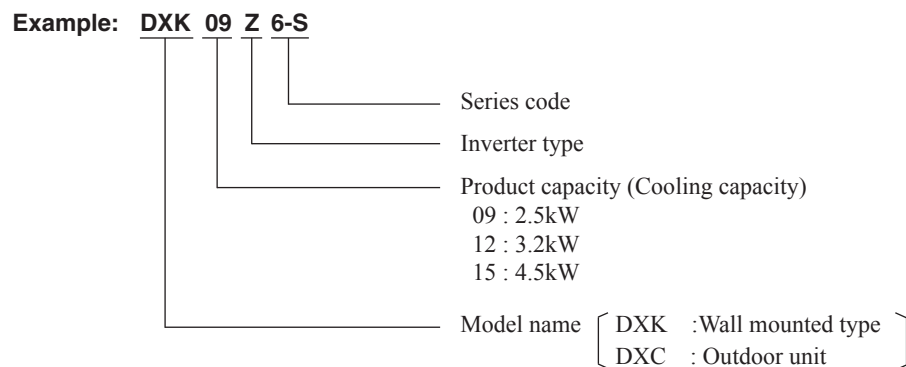

1. SPECIFICATIONS

Model DXK09Z6-S

Item		Model		DXK09Z6-S		
		Indoor unit	DXK09Z6-S	Outdoor unit	DXC09Z6-S	
Power source		1 Phase, 220 - 240V, 50Hz				
Operation data	Nominal cooling capacity (range)	kW	2.5 (0.9 (Min.) - 2.8 (Max.))			
	Nominal heating capacity (range)	kW	2.8 (0.8 (Min.) - 3.9 (Max.))			
	Heating capacity (H2)	kW	-			
	Power consumption	Cooling	kW	0.780 (0.25 - 1.01)		
		Heating		0.755 (0.20 - 1.43)		
		Heating (H2)		-		
	Max power consumption		1.65			
	Running current	Cooling	A	3.9 / 3.8 / 3.6 (220/ 230/ 240V)		
		Heating		3.9 / 3.7 / 3.5 (220/ 230/ 240V)		
	Inrush current, max current			3.9 / 3.8 / 3.6 (220/ 230/ 240V)	Max. 9	
	Power factor	Cooling	%	90		
		Heating		89		
	EER	Cooling		3.21		
	COP	Heating		3.71		
Heating (H2)			-			
Sound power level	Cooling	dB(A)	58			
	Heating		57			
Sound pressure level	Cooling		Hi: 45 Me: 34 Lo: 23	47		
	Heating		Hi: 43 Me: 34 Lo: 26	45		
Silent mode sound pressure level			-			
Exterior dimensions (Height x Width x Depth)	mm	267 x 783 x 210		540 x 645(+57) x 275		
Exterior appearance (Equivalent color)		Fine snow Munsell: (8.0Y 9.3/0.1), RAL: 9003		Stucco white Munsell: (4.2Y 7.5/1.1), RAL: 7044		
Net weight	kg	7.0		25		
Compressor type & Quantity		-		RM-B5077MDE5(Rotary type) x 1		
Compressor motor (Starting method)	kW	-		0.75 (Inverter driven)		
Refrigerant oil (Amount, type)	ℓ	-		0.3 (DIAMOND FREEZE MA68)		
Refrigerant (Type, amount, pre-charge length)	kg	R410A 0.655 in outdoor unit (Incl. the amount for the piping of 10m)				
Heat exchanger		Louver fins & inner grooved tubing		M fins & inner grooved tubing		
Refrigerant control		Capillary tubes + Electronic expansion valve				
Fan type & Quantity		Tangential fan x 1		Propeller fan x 1		
Fan motor (Starting method)	W	30 x1 (Direct drive)		24 x1 (Direct drive)		
Air flow	Cooling	m ³ /min	Hi: 10.0 Me: 7.3 Lo: 4.2		26.0	
	Heating		Hi: 9.5 Me: 7.3 Lo: 5.2		19.7	
Available external static pressure	Pa	0		0		
Outside air intake		Not possible				
Air filter, Quality / Quantity		Polypropylene net (Washable)				
Shock & vibration absorber		Rubber sleeve (for fan motor)		Rubber sleeve (for fan motor & compressor)		
Electric heater		-				
Operation control	Remote control	Wireless remote control				
	Room temperature control	Microcomputer thermostat				
	Operation display	RUN: Green , TIMER: Yellow				
Safety equipments		Compressor overheat protection, Overcurrent protection, Frost protection, Serial signal error protection, Indoor fan motor error protection, Heating overload protection(High pressure control), Cooling overload protection				
Installation data	Refrigerant piping size (O.D)	mm	Liquid line: φ6.35 (1/4")		Gas line: φ9.52 (3/8")	
	Connecting method		Flare connection		Flare connection	
	Attached length of piping	m	Liquid line : 0.39 / Gas line : 0.32		-	
	Insulation for piping		Necessary (Both sides), independent			
	Refrigerant line (one way) length	m	Max.15			
	Vertical height diff. between O.U. and I.U.	m	Max.10 (Outdoor unit is higher) / Max.10 (Outdoor unit is lower)			
Drain hose		Hose connectable (VP16)		Hole φ20 x 2 pcs		
Drain pump, max lift height	mm	-				
Recommended breaker size	A	16				
L.R.A. (Locked rotor ampere)	A	3.9 / 3.8 / 3.6 (220/ 230/ 240V)				
Interconnecting wires	Size x Core number	1.5mm ² x 4 cores (Including earth cable) / Terminal block (Screw fixing type)				
IP number		IPX0		IPX4		
Standard accessories		Mounting kit				
Option parts		-				
Notes (1) The data are measured at the following conditions. The pipe length is 5m.						
Operation	Item	Indoor air temperature		Outdoor air temperature		Standards
		DB	WB	DB	WB	
	Cooling	27°C	19°C	35°C	24°C	ISO5151-T1
	Heating	20°C	—	7°C	6°C	ISO5151-H1
Heating (H2)	20°C	—	2°C	1°C	ISO5151-H2	
(2) This air-conditioner is manufactured and tested in conformity with the ISO.						
(3) Sound level indicates the value in an anechoic chamber. During operation these values are somewhat higher due to ambient conditions.						
(4) Select the breaker size according to the own national standard.						

Model DXK12Z6-S

Item		Model		DXK12Z6-S		
		Indoor unit	DXK12Z6-S	Outdoor unit	DXC12Z6-S	
Power source		1 Phase, 220 - 240V, 50Hz				
Operation data	Nominal cooling capacity (range)	kW		3.2 (0.9 (Min.) - 3.5 (Max.))		
	Nominal heating capacity (range)	kW		3.6 (0.9 (Min.) - 4.3 (Max.))		
	Heating capacity (H2)	kW		-		
	Power consumption	Cooling	kW		0.995 (0.23 - 1.32)	
		Heating	kW		0.995 (0.19 - 1.31)	
		Heating (H2)	kW		-	
	Max power consumption	kW		1.65		
	Running current	Cooling	A		4.9 / 4.7 / 4.5 (220/ 230/ 240V)	
		Heating	A		4.9 / 4.7 / 4.5 (220/ 230/ 240V)	
	Inrush current, max current	A		4.9 / 4.7 / 4.5 (220/ 230/ 240V) Max. 9		
	Power factor	Cooling	%		93	
		Heating	%		93	
	EER	Cooling			3.22	
	COP	Heating			3.62	
Heating (H2)				-		
Sound power level	Cooling	dB(A)		59		
	Heating	dB(A)		60		
Sound pressure level	Cooling	dB(A)		Hi: 45 Me: 36 Lo: 23		
	Heating	dB(A)		Hi: 44 Me: 36 Lo: 28		
Silent mode sound pressure level	dB(A)		-			
Exterior dimensions (Height x Width x Depth)	mm		267 x 783 x 210			
Exterior appearance (Equivalent color)			Fine snow Munsell: (8.0Y 9.3/0.1), RAL: 9003			
Net weight	kg		7.0			
Compressor type & Quantity			-			
Compressor motor (Starting method)	kW		-			
Refrigerant oil (Amount, type)	ℓ		-			
Refrigerant (Type, amount, pre-charge length)	kg		R410A 0.81 in outdoor unit (Incl. the amount for the piping of 15m)			
Heat exchanger			Louver fins & inner grooved tubing			
Refrigerant control			Capillary tubes + Electronic expansion valve			
Fan type & Quantity			Tangential fan x 1			
Fan motor (Starting method)	W		30 x1 (Direct drive)			
Air flow	Cooling	m ³ /min		Hi: 9.5 Me: 6.8 Lo: 4.2		
	Heating	m ³ /min		Hi: 9.6 Me: 7.4 Lo: 5.5		
Available external static pressure	Pa		0			
Outside air intake			Not possible			
Air filter, Quality / Quantity			Polypropylene net (Washable)			
Shock & vibration absorber			Rubber sleeve (for fan motor)			
Electric heater			-			
Operation control	Remote control			Wireless remote control		
	Room temperature control			Microcomputer thermostat		
	Operation display			RUN: Green , TIMER: Yellow		
Safety equipments			Compressor overheat protection, Overcurrent protection, Frost protection, Serial signal error protection, Indoor fan motor error protection, Heating overload protection(High pressure control), Cooling overload protection			
Installation data	Refrigerant piping size (O.D)	mm		Liquid line: φ6.35 (1/4") Gas line: φ9.52 (3/8")		
	Connecting method			Flare connection		
	Attached length of piping	m		Liquid line : 0.39 / Gas line : 0.32		
	Insulation for piping			Necessary (Both sides), independent		
	Refrigerant line (one way) length	m		Max.15		
	Vertical height diff. between O.U. and I.U.	m		Max.10 (Outdoor unit is higher) / Max.10 (Outdoor unit is lower)		
Drain hose			Hose connectable (VP16)			
Drain pump, max lift height	mm		-			
Recommended breaker size	A		16			
L.R.A. (Locked rotor ampere)	A		4.9 / 4.7 / 4.5 (220/ 230/ 240V)			
Interconnecting wires	Size x Core number		1.5mm ² x 4 cores (Including earth cable) / Terminal block (Screw fixing type)			
IP number			IPX0			
Standard accessories			Mounting kit			
Option parts			-			
Notes (1) The data are measured at the following conditions. The pipe length is 5m.						
Operation	Item	Indoor air temperature		Outdoor air temperature		Standards
		DB	WB	DB	WB	
	Cooling	27°C	19°C	35°C	24°C	ISO5151-T1
	Heating	20°C	-	7°C	6°C	ISO5151-H1
Heating (H2)	20°C	-	2°C	1°C	ISO5151-H2	
(2) This air-conditioner is manufactured and tested in conformity with the ISO.						
(3) Sound level indicates the value in an anechoic chamber. During operation these values are somewhat higher due to ambient conditions.						
(4) Select the breaker size according to the own national standard.						

Model DXK15Z6-S

Item		Model		DXK15Z6-S		
		Indoor unit	DXK15Z6-S	Outdoor unit	DXC15Z6-S	
Power source		1 Phase, 220 - 240V, 50Hz				
Operation data	Nominal cooling capacity (range)	kW	4.5 (0.9 (Min.) - 4.8 (Max.))			
	Nominal heating capacity (range)	kW	5.0 (0.8 (Min.) - 5.8 (Max.))			
	Heating capacity (H2)	kW	-			
	Power consumption	Cooling	kW	1.495 (0.22 - 1.98)		
		Heating		1.385 (0.20 - 1.86)		
		Heating (H2)		-		
	Max power consumption		2.68			
	Running current	Cooling	A	7.0 / 6.7 / 6.4 (220/ 230/ 240V)		
		Heating		6.5 / 6.2 / 6.0 (220/ 230/ 240V)		
	Inrush current, max current			7.0 / 6.7 / 6.4 (220/ 230/ 240V)	Max. 14	
	Power factor	Cooling	%	97		
		Heating		97		
	EER	Cooling		3.01		
	COP	Heating		3.61		
Heating (H2)			-			
Sound power level	Cooling	dB(A)	58			
	Heating		62			
Sound pressure level	Cooling		Hi: 44 Me: 39 Lo: 24		51	
	Heating		Hi: 48 Me: 41 Lo: 30		51	
Silent mode sound pressure level			-			
Exterior dimensions (Height x Width x Depth)	mm	267 x 783 x 210		595 x 780(+62) x 290		
Exterior appearance (Equivalent color)		Fine snow Munsell: (8.0Y 9.3/0.1), RAL: 9003		Stucco white Munsell: (4.2Y 7.5/1.1), RAL: 7044		
Net weight	kg	7.5		40		
Compressor type & Quantity		-		GKT128MFA(Twin Rotary type) x 1		
Compressor motor (Starting method)	kW	-		1.10 (Inverter driven)		
Refrigerant oil (Amount, type)	ℓ	-		0.45 (FVC68D)		
Refrigerant (Type, amount, pre-charge length)	kg	R410A 1.20 in outdoor unit (Incl. the amount for the piping of 15m)				
Heat exchanger		Louver fins & inner grooved tubing		M fins & inner grooved tubing		
Refrigerant control		Capillary tubes + Electronic expansion valve				
Fan type & Quantity		Tangential fan x 1		Propeller fan x 1		
Fan motor (Starting method)	W	30 x1 (Direct drive)		24 x1 (Direct drive)		
Air flow	Cooling	m ³ /min	Hi: 9.0 Me: 7.2 Lo: 3.8		35.5	
	Heating		Hi: 12.0 Me: 9.2 Lo: 6.2		33.5	
Available external static pressure	Pa	0		0		
Outside air intake		Not possible				
Air filter, Quality / Quantity		Polypropylene net (Washable)				
Shock & vibration absorber		Rubber sleeve (for fan motor)		Rubber sleeve (for fan motor & compressor)		
Electric heater		-				
Operation control	Remote control	Wireless remote control				
	Room temperature control	Microcomputer thermostat				
	Operation display	RUN: Green , TIMER: Yellow				
Safety equipments		Compressor overheat protection, Overcurrent protection, Frost protection, Serial signal error protection, Indoor fan motor error protection, Heating overload protection(High pressure control), Cooling overload protection				
Installation data	Refrigerant piping size (O.D)	mm	Liquid line: ϕ 6.35 (1/4")		Gas line: ϕ 12.7 (1/2")	
	Connecting method		Flare connection		Flare connection	
	Attached length of piping	m	Liquid line : 0.39 / Gas line : 0.32		-	
	Insulation for piping		Necessary (Both sides), independent			
	Refrigerant line (one way) length	m	Max.25			
	Vertical height diff. between O.U. and I.U.	m	Max.15 (Outdoor unit is higher) / Max.15 (Outdoor unit is lower)			
Drain hose		Hose connectable (VP16)		Hole ϕ 20 x 2 pcs		
Drain pump, max lift height	mm	-				
Recommended breaker size	A	20				
L.R.A. (Locked rotor ampere)	A	7.0 / 6.7 / 6.4 (220/ 230/ 240V)				
Interconnecting wires	Size x Core number	1.5mm ² x 4 cores (Including earth cable) / Terminal block (Screw fixing type)				
IP number		IPX0		IPX4		
Standard accessories		Mounting kit				
Option parts		-				
Notes (1) The data are measured at the following conditions. The pipe length is 5m.						
Operation	Item	Indoor air temperature		Outdoor air temperature		Standards
		DB	WB	DB	WB	
	Cooling	27°C	19°C	35°C	24°C	ISO5151-T1
	Heating	20°C	—	7°C	6°C	ISO5151-H1
Heating (H2)	20°C	—	2°C	1°C	ISO5151-H2	
(2) This air-conditioner is manufactured and tested in conformity with the ISO.						
(3) Sound level indicates the value in an anechoic chamber. During operation these values are somewhat higher due to ambient conditions.						
(4) Select the breaker size according to the own national standard.						

Weight List (Package)

【Indoor unit & outdoor unit】

Unit : kg

Material Model		Gross weight	Packing Parts weight	Paper	Foam poly-styrene	Plastic	Steel	Aluminium	Wood	Glass	Others
Indoor	DXK09Z6-S	9.0	0.94	0.64	0.24	0.06	0.00	0.00	0.00	0.00	0.00
	DXK12Z6-S	9.0	0.94	0.64	0.24	0.06	0.00	0.00	0.00	0.00	0.00
	DXK15Z6-S	9.5	0.94	0.64	0.24	0.06	0.00	0.00	0.00	0.00	0.00
Outdoor	DXC09Z6-S	27.0	1.64	1.36	0.24	0.04	0.00	0.00	0.00	0.00	0.00
	DXC12Z6-S	29.0	1.64	1.36	0.24	0.04	0.00	0.00	0.00	0.00	0.00
	DXC15Z6-S	42.0	2.13	1.78	0.27	0.08	0.00	0.00	0.00	0.00	0.00

2. EXTERIOR DIMENSIONS

(1) Indoor units

Models DXK09Z6-S, 12Z6-S, 15Z6-S

Symbol	Content
A	Gas piping DXK 09,12 ϕ 9.52(3/8") (Flare) DXK15 ϕ 12.7(1/2") (Flare)
B	Liquid piping ϕ 6.35(1/4") (Flare)
C	Hole on wall for right rear piping (ϕ 65)
D	Hole on wall for left rear piping (ϕ 65)
E	Drain hose VP16
F	Outlet for wiring
G	Outlet for piping (on both side)

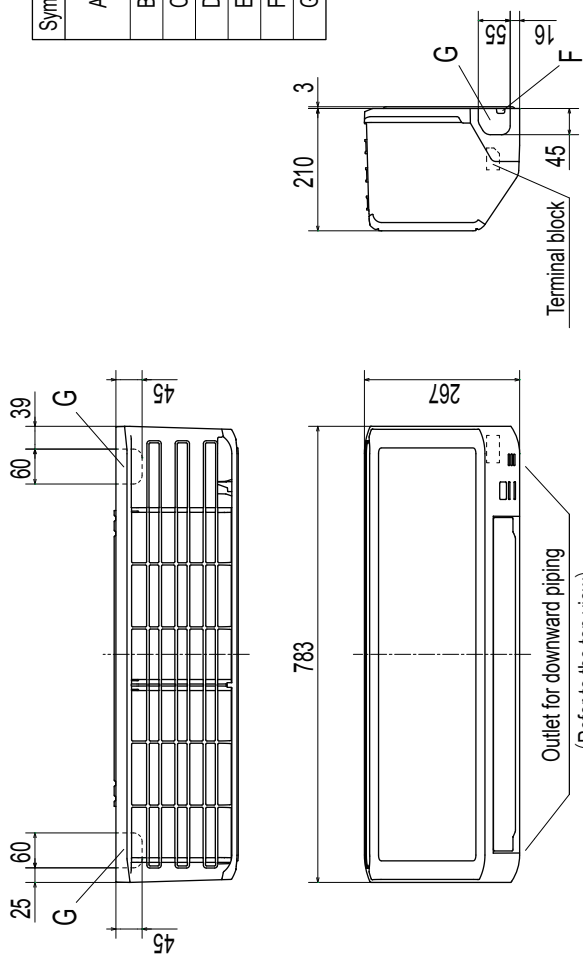

Terminal block

※	Service space Recommendation	65	80
---	------------------------------	----	----

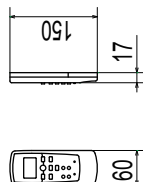

Note (1) The model name label is attached on the underside of the indoor unit.

Unit:mm

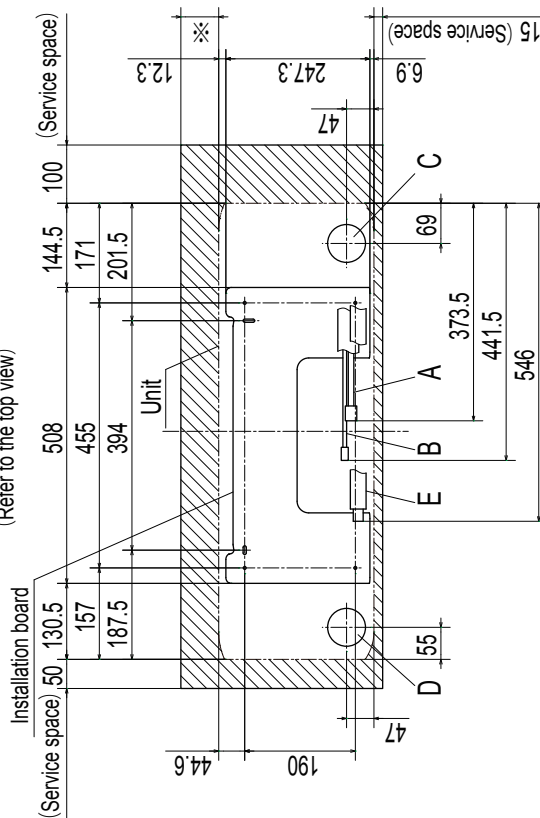

Space for installation and service when viewing from the front

(2) Outdoor units

Models DXC09Z6-S, 12Z6-S

Notes

- (1) The unit must not be surrounded by walls on the four sides.
- (2) The unit must be fixed with anchor bolts.
- (3) An anchor bolt must not protrude more than 15mm.
- (4) If the unit is installed in the location where there is a possibility of strong winds, place the unit such that the direction of air from the outlet gets perpendicular to the wind direction.
- (5) Leave 200mm or more space above the unit.
- (6) The model name label is attached on the lower right corner of the front panel.

Symbol	Content
A	Service valve connection (gas side) $\phi 9.52 (3/8")$ (Flare)
B	Service valve connection (liquid side) $\phi 6.35 (1/4")$ (Flare)
C	Pipe/cable draw-out hole
D	Drain discharge hole $\phi 20 \times 2$ places
E	Anchor bolt hole M10-12x4 places

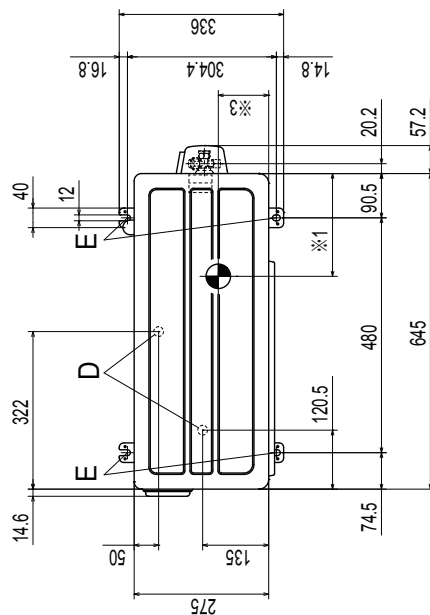

Dimensions	※1	※2	※3
Model			
DXC09Z6-S	210	240	103
DXC12Z6-S	220	240	108

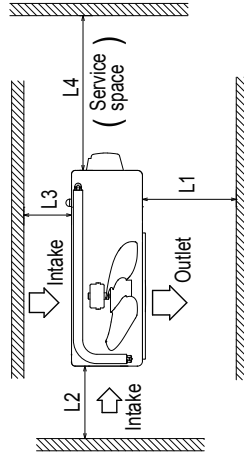
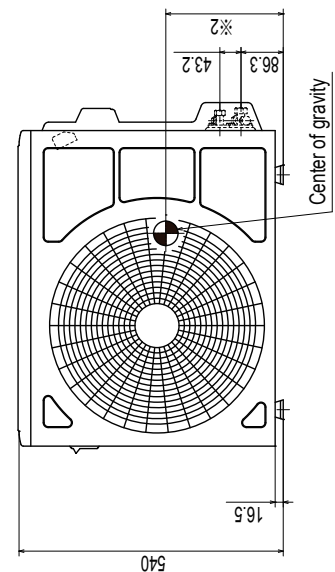

	Installation space (mm)
L1	280 or more
L2	100 or more
L3	80 or more
L4	250 or more

Unit:mm

Model DXC15Z6-S

Notes

- (1) The unit must not be surrounded by walls on the four sides.
- (2) The unit must be fixed with anchor bolts.
An anchor bolt must not protrude more than 15mm.
- (3) If the unit is installed in the location where there is a possibility of strong winds, place the unit such that the direction of air from the outlet gets perpendicular to the wind direction.
- (4) Leave 200mm or more space above the unit.
- (5) The wall height on the outlet side should be 1200mm or less.
- (6) The model name label is attached on the lower right corner of the front panel.

Symbol	Content
A	Service valve connection (gas side) φ 12.7 (1 / 2") (Flare)
B	Service valve connection (liquid side) φ 6.35 (1 / 4") (Flare)
C	Pipe / cable draw-out hole
D	Drain discharge hole φ 20×2 places
E	Anchor bolt hole M10-12×4 places

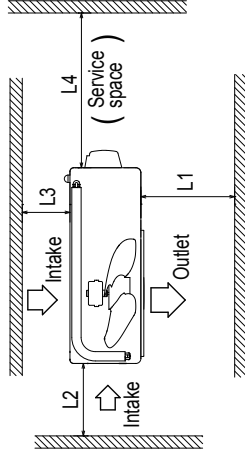
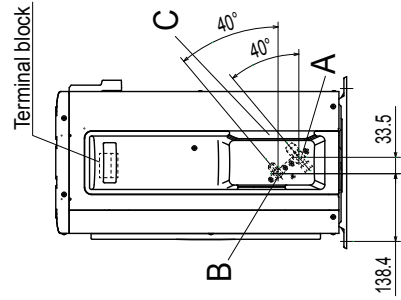
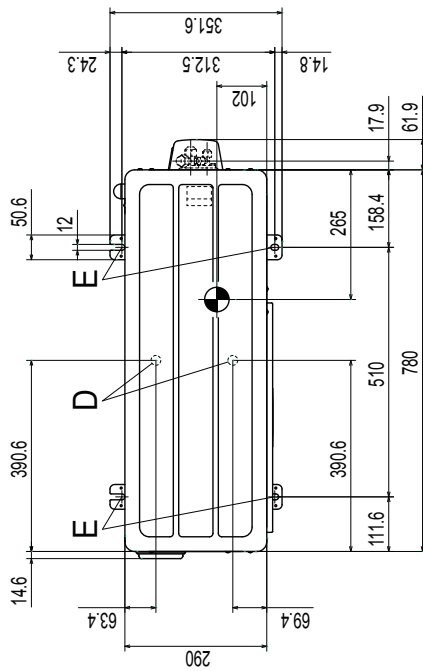

	Installation space (mm)
L1	280 or more
L2	100 or more
L3	80 or more
L4	250 or more

Unit:mm

(3) Wireless remote control

Unit: mm

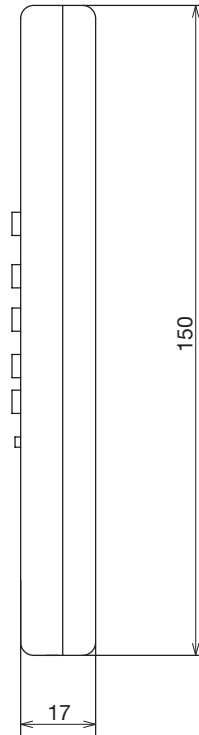
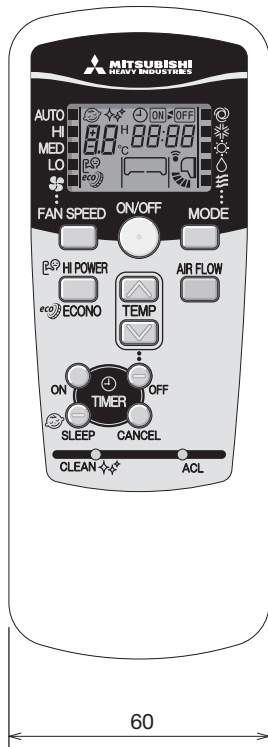

3. ELECTRICAL WIRING

(1) Indoor units

Models DXK09Z6-S, 12Z6-S, 15Z6-S

Meaning of marks	
Item	Description
CNE	Connector
CNF	
CNG	
CNM	
CNU	

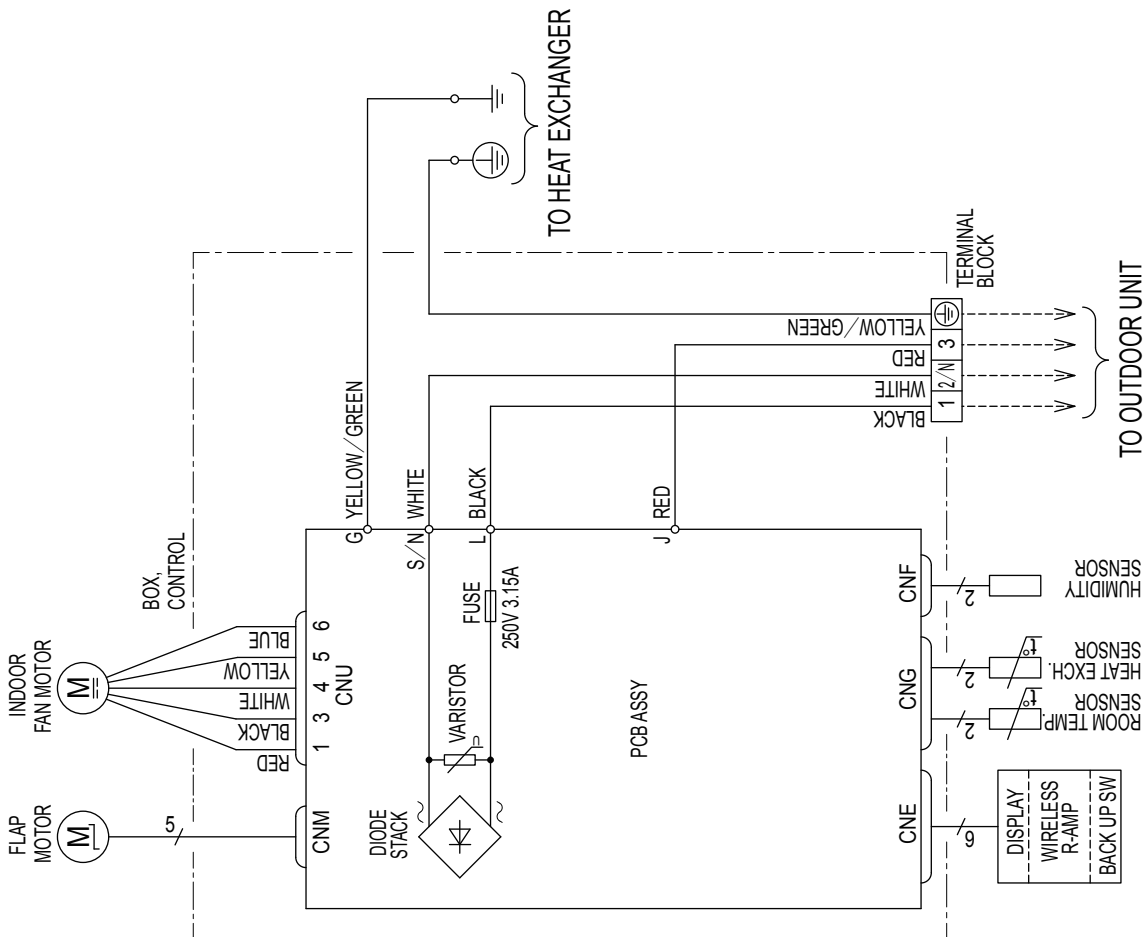

(2) Outdoor units

Models DXC09Z6-S, 12Z6-S, 15Z6-S

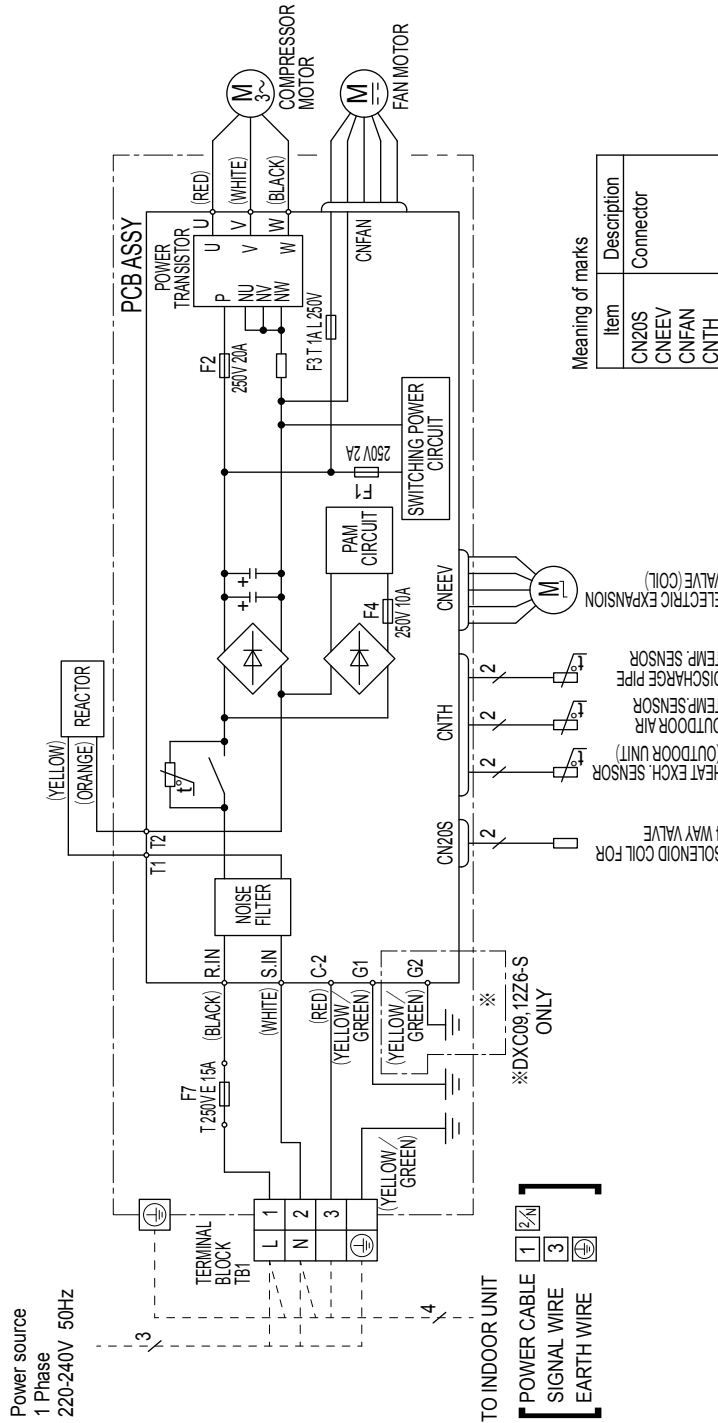

Power cable, indoor-outdoor connecting wires

Model	MAX running current (A)	Power cable wire size x number*	Power cable length (m)	Connecting cable wire size x number*
09,12	9	2.0mm ² x 3	22	1.5mm ² x 4
15	14	2.0mm ² x 3	14	1.5mm ² x 4

- * The wire numbers include Earth wire (Yellow/Green)
- The specifications shown in the above table are for units without heaters. For units with heaters, refer to the installation instructions or the construction instructions of the indoor unit.
- Switchgear or Circuit breaker capacity should be chosen according to national or regional electricity regulations.
- The power cable specifications are based on the assumption that a metal or plastic conduit is used with no more than three cables contained in a conduit and a voltage drop is 2%. For an installation falling outside of these conditions, please follow the national or regional electricity regulations.

4. NOISE LEVEL

(1) Sound power level

Model DXK09Z6-S

(Indoor Unit)

Model	DXK09Z6-S	
Noise Level	Cooling	58 dB(A)
	Heating	57 dB(A)

Condition	ISO5151 T1/H1
MODE	Rated capacity value (Hi)

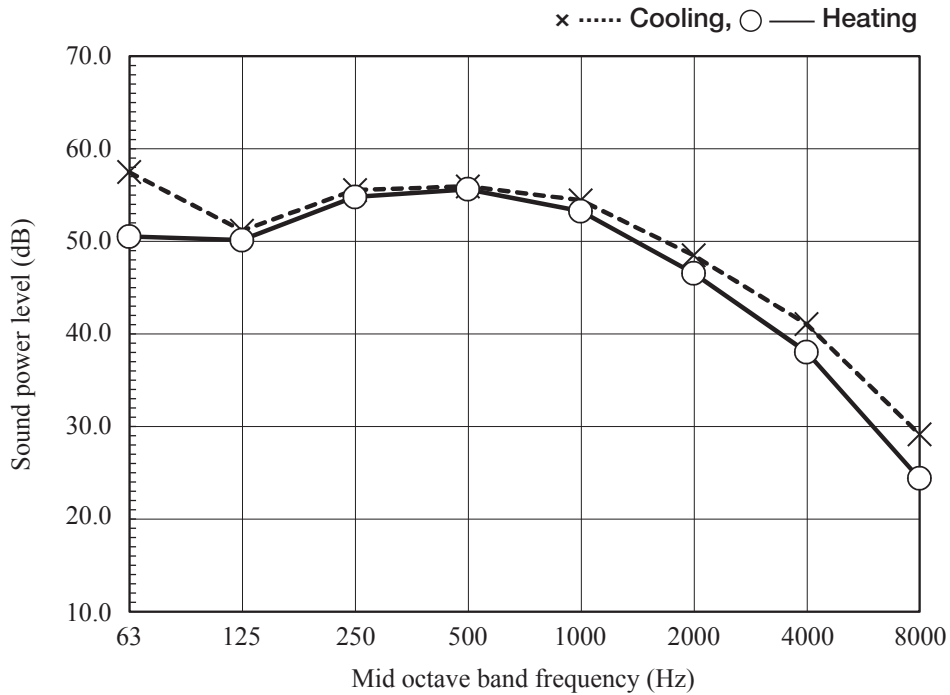

(Outdoor Unit)

Model	DXC09Z6-S	
Noise Level	Cooling	58 dB(A)
	Heating	59 dB(A)

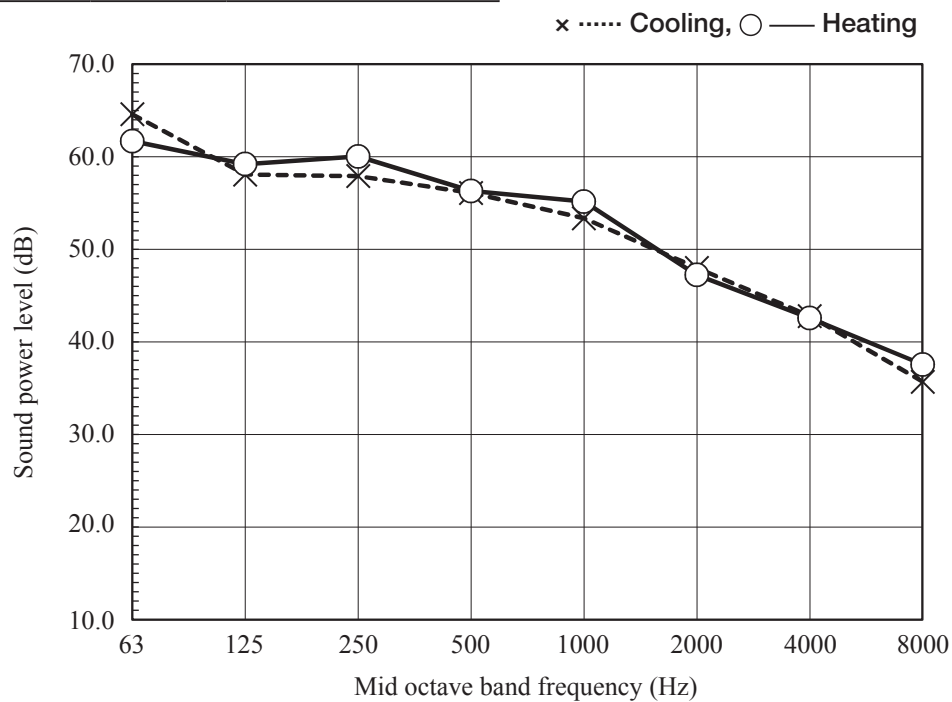

Model DXK12Z6-S

(Indoor Unit)

Model	DXK12Z6-S	
Noise Level	Cooling	59 dB(A)
	Heating	58 dB(A)

Condition	ISO5151 T1/H1
MODE	Rated capacity value (Hi)

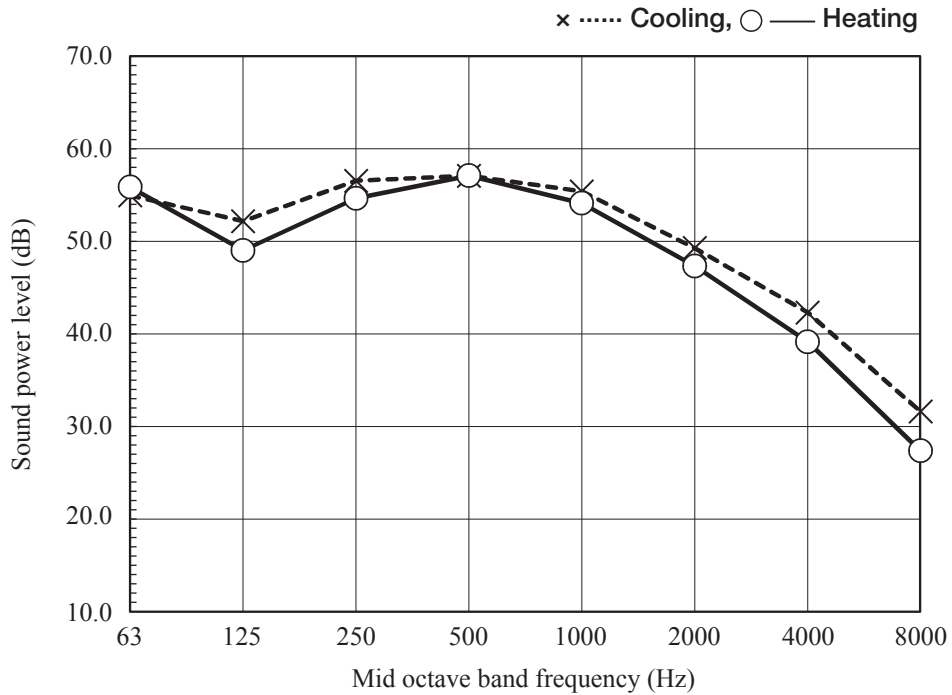

(Outdoor Unit)

Model	DXC12Z6-S	
Noise Level	Cooling	60 dB(A)
	Heating	60 dB(A)

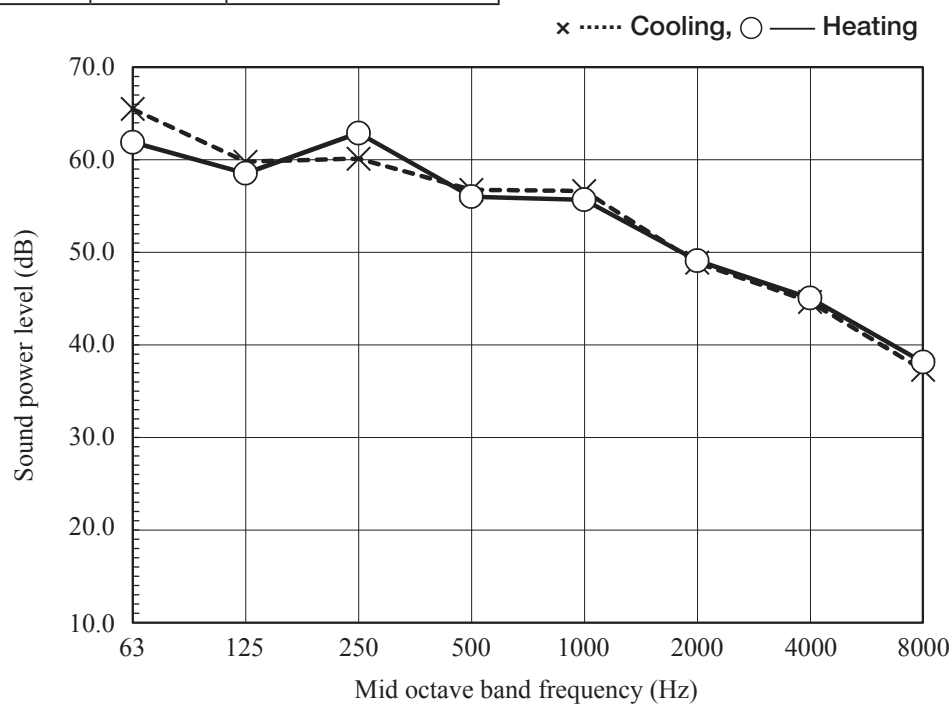

Model DXK15Z6-S

(Indoor Unit)

Model	DXK15Z6-S	
Noise Level	Cooling	58 dB(A)
	Heating	62 dB(A)

Condition	ISO5151 T1/H1
MODE	Rated capacity value (Hi)

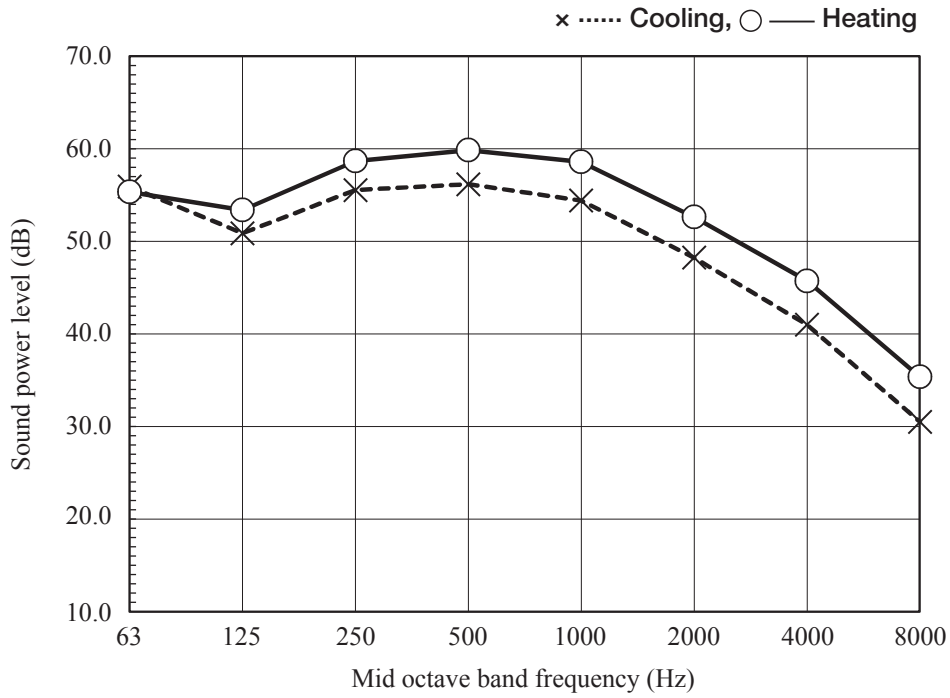

(Outdoor Unit)

Model	DXC15Z6-S	
Noise Level	Cooling	63 dB(A)
	Heating	64 dB(A)

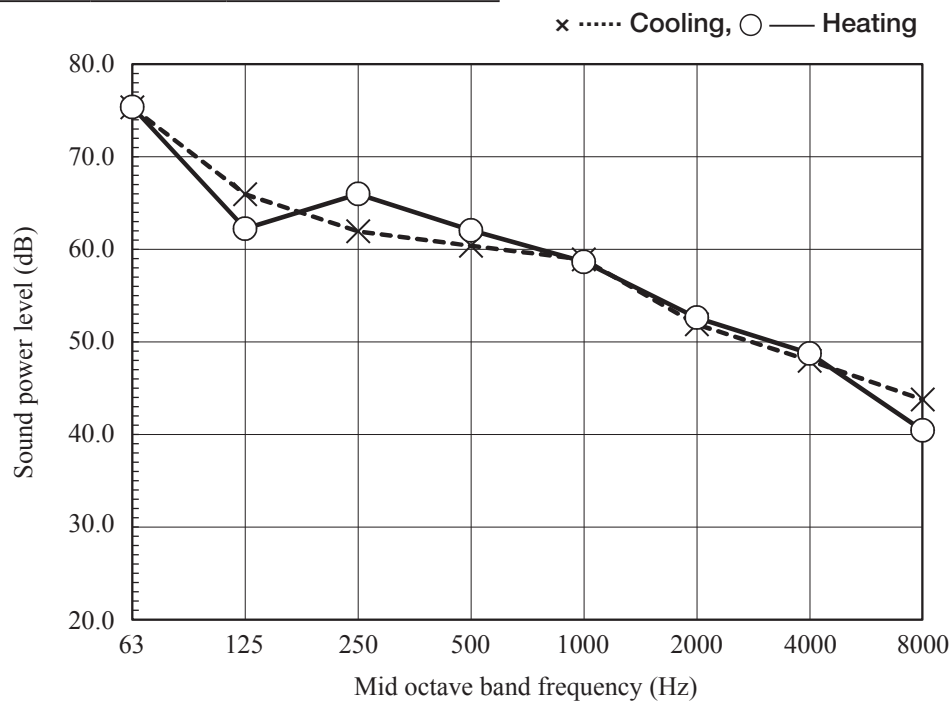

(2) Sound pressure level

(a) Rated capacity value

Model DXK09Z6-S

(Indoor Unit)

Model	DXK09Z6-S	
Noise Level	Cooling	45 dB(A)
	Heating	43 dB(A)

Condition	ISO5151 T1/H1
MODE	Rated capacity value (Hi)

● Mike position

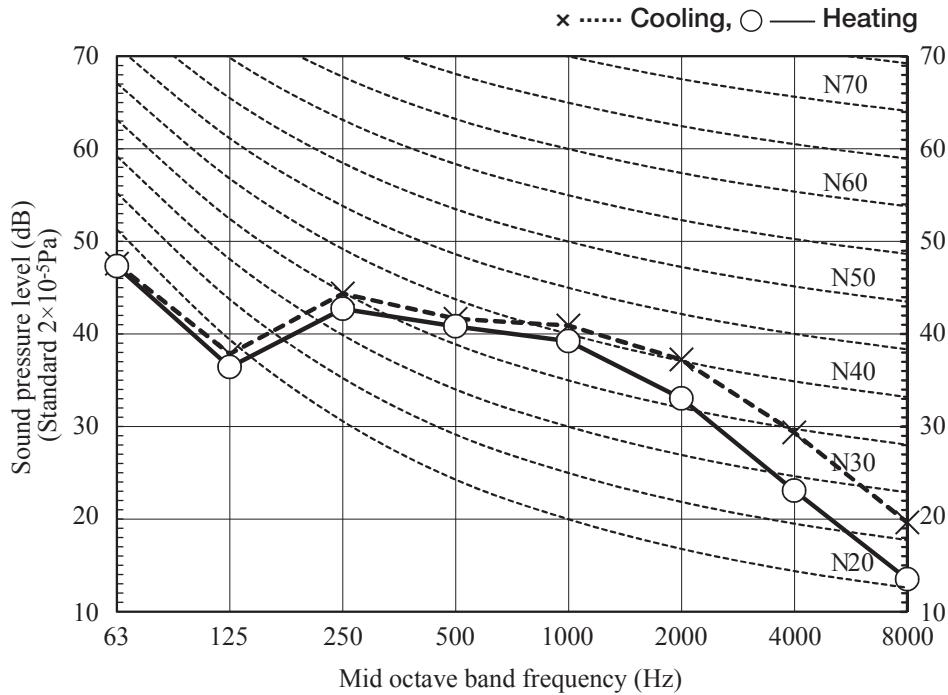

(Outdoor Unit)

Model	DXC09Z6-S	
Noise Level	Cooling	47 dB(A)
	Heating	45 dB(A)

● Mike position: at highest noise level in position as mentioned below

Distance from front side 1m

x Cooling, ○ — Heating

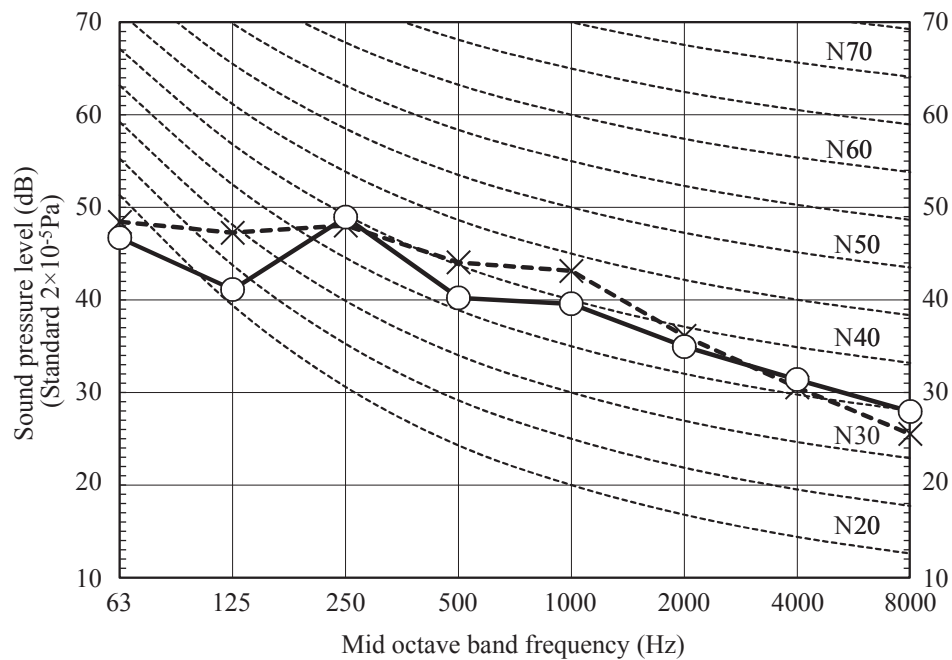

Model DXK12Z6-S

(Indoor Unit)

Model	DXK12Z6-S	
Noise Level	Cooling	45 dB(A)
	Heating	44 dB(A)

Condition	ISO5151 T1/H1
MODE	Rated capacity value (Hi)

● Mike position

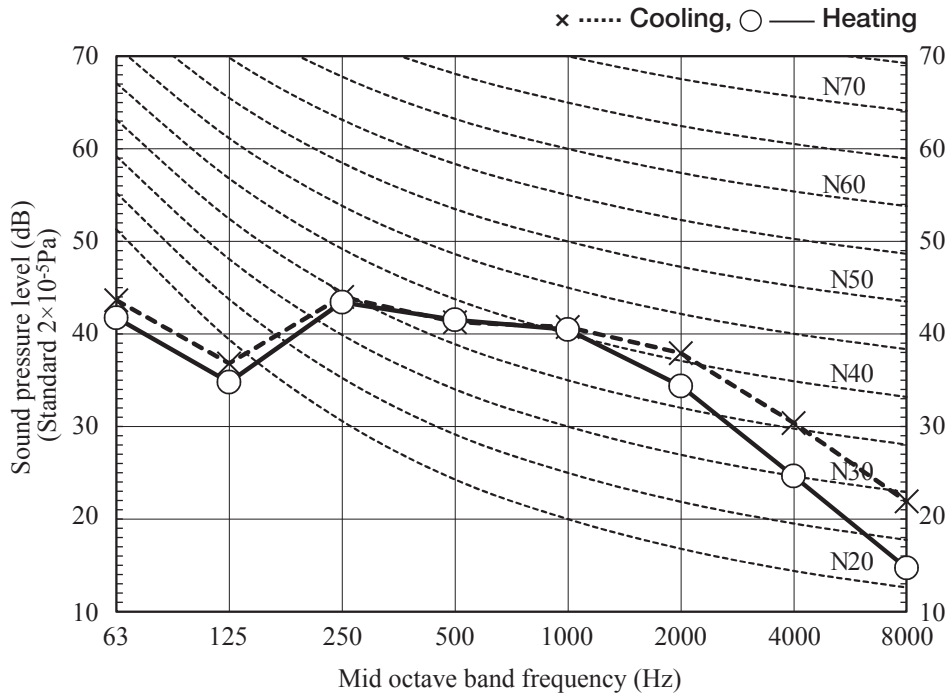

(Outdoor Unit)

Model	DXC12Z6-S	
Noise Level	Cooling	47 dB(A)
	Heating	48 dB(A)

● Mike position: at highest noise level in position as mentioned below
Distance from front side 1m

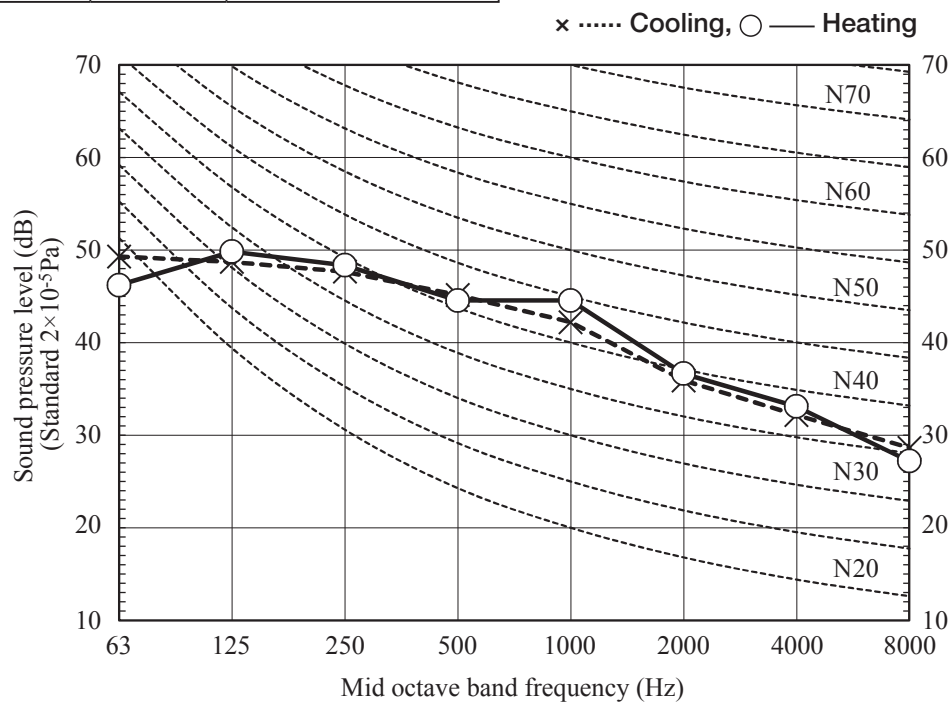

Model DXK15Z6-S

(Indoor Unit)

Model	DXK15Z6-S	
Noise Level	Cooling	44 dB(A)
	Heating	48 dB(A)

Condition	ISO5151 T1/H1
MODE	Rated capacity value (Hi)

● Mike position

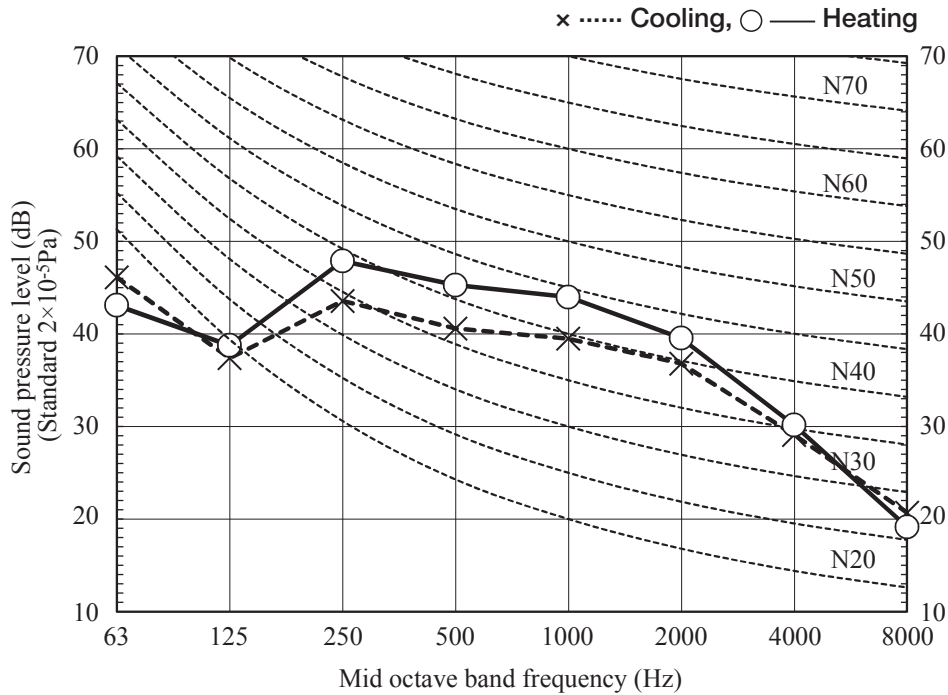

(Outdoor Unit)

Model	DXC15Z6-S	
Noise Level	Cooling	51 dB(A)
	Heating	51 dB(A)

● Mike position: at highest noise level in position as mentioned below
Distance from front side 1m

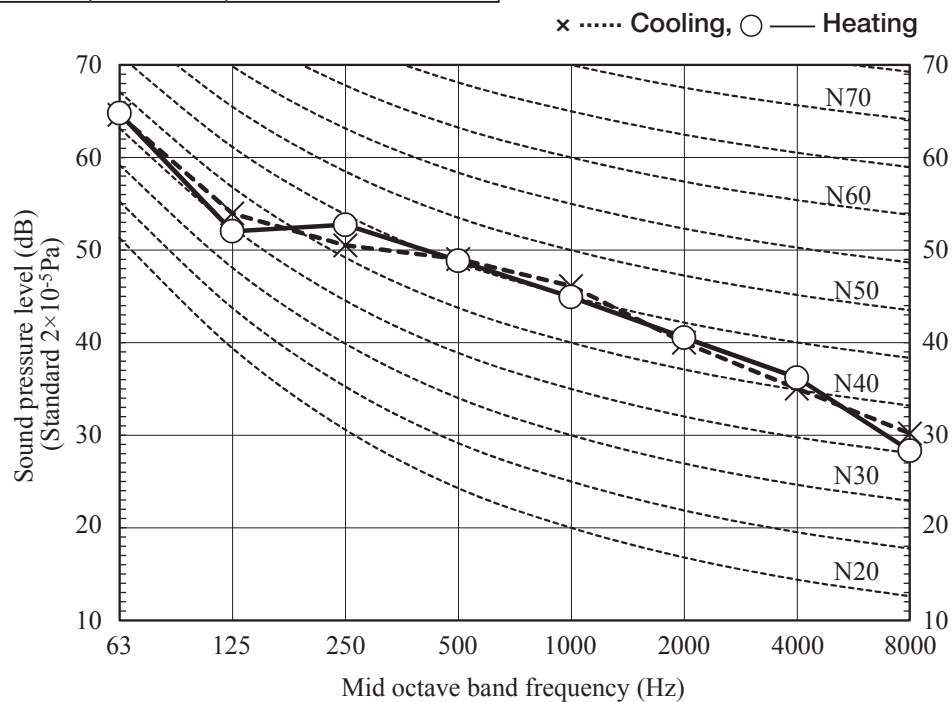

(b) Each fan speed mode

Condition	ISO5151 T1/H1
-----------	---------------

MODE	Me
------	----

(Indoor Unit)

Model	DXK09Z6-S	
Noise Level	Cooling	34 dB(A)
	Heating	34 dB(A)

● Mike position

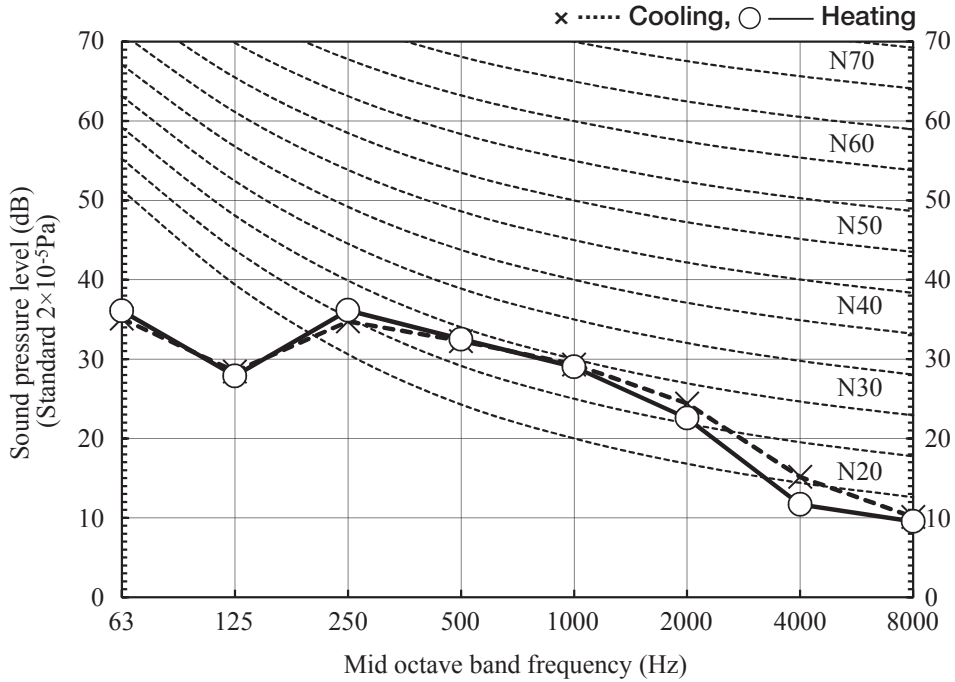

(Indoor Unit)

Model	DXK09Z6-S	
Noise Level	Cooling	23 dB(A)
	Heating	26 dB(A)

MODE	Lo
------	----

● Mike position

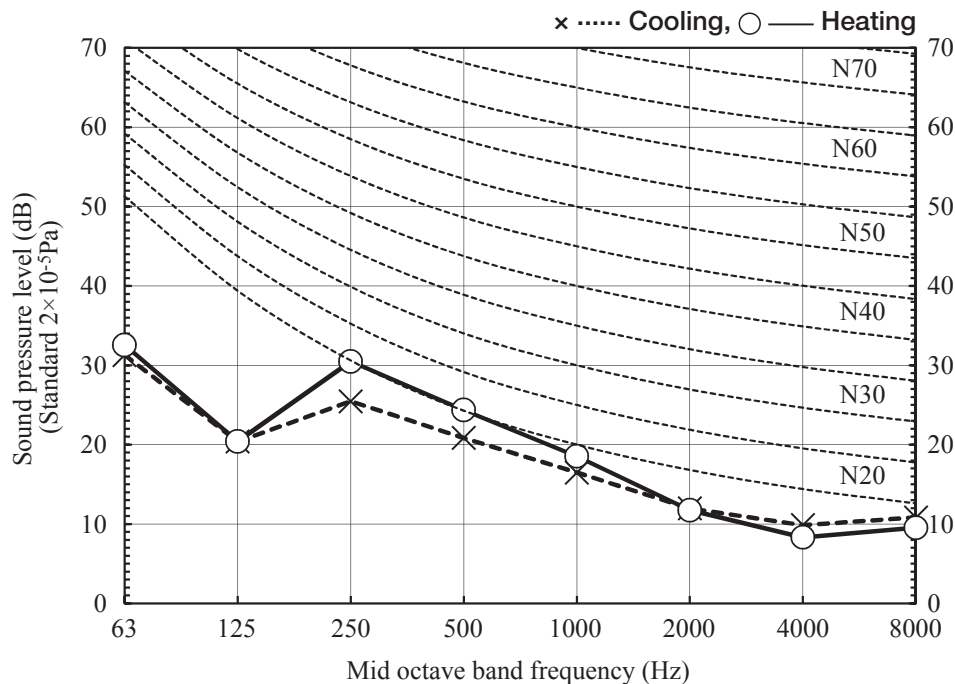

(Indoor Unit)

Model	DXK12Z6-S	
Noise Level	Cooling	36 dB(A)
	Heating	36 dB(A)

Condition	ISO5151 T1/H1
MODE	Me

● Mike position

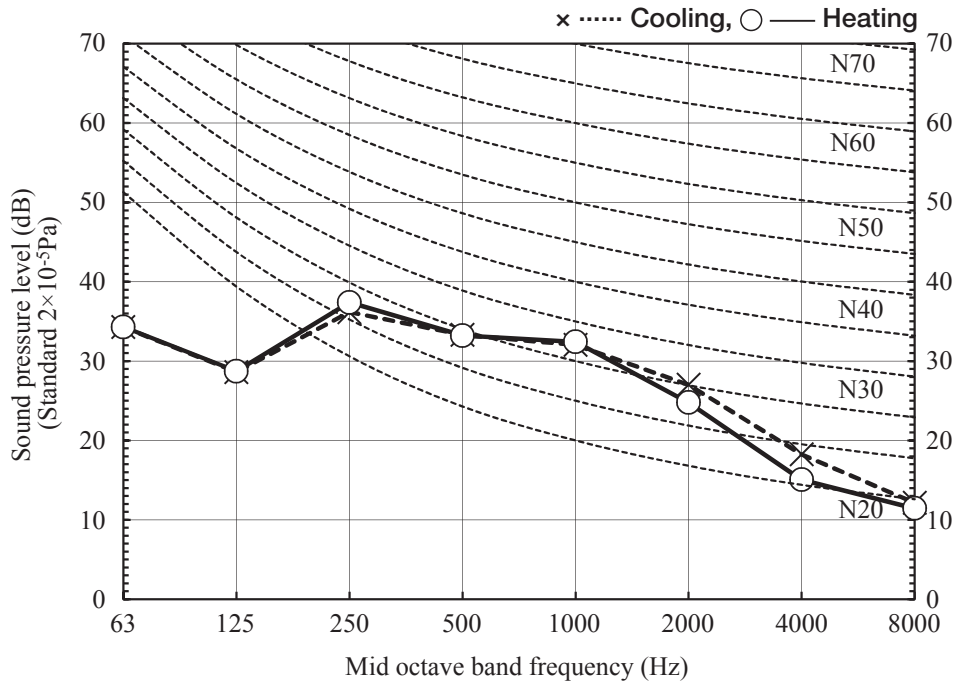

(Indoor Unit)

Model	DXK12Z6-S	
Noise Level	Cooling	23 dB(A)
	Heating	28 dB(A)

MODE	Lo
------	----

● Mike position

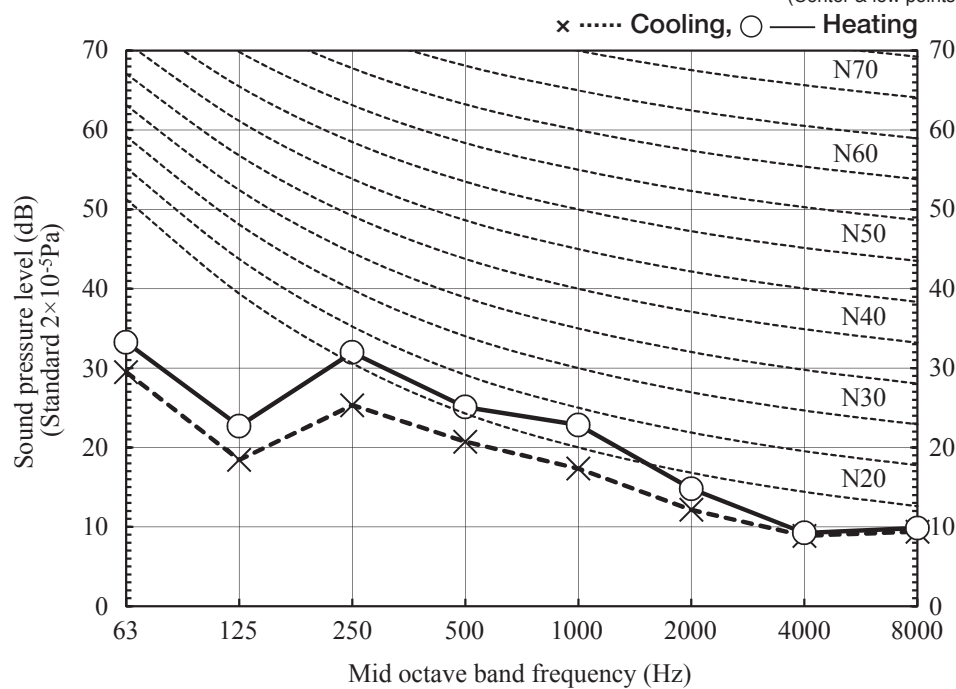

(Indoor Unit)

Model	DXK15Z6-S	
Noise Level	Cooling	39 dB(A)
	Heating	41 dB(A)

Condition	ISO5151 T1/H1
-----------	---------------

MODE	Me
------	----

● Mike position

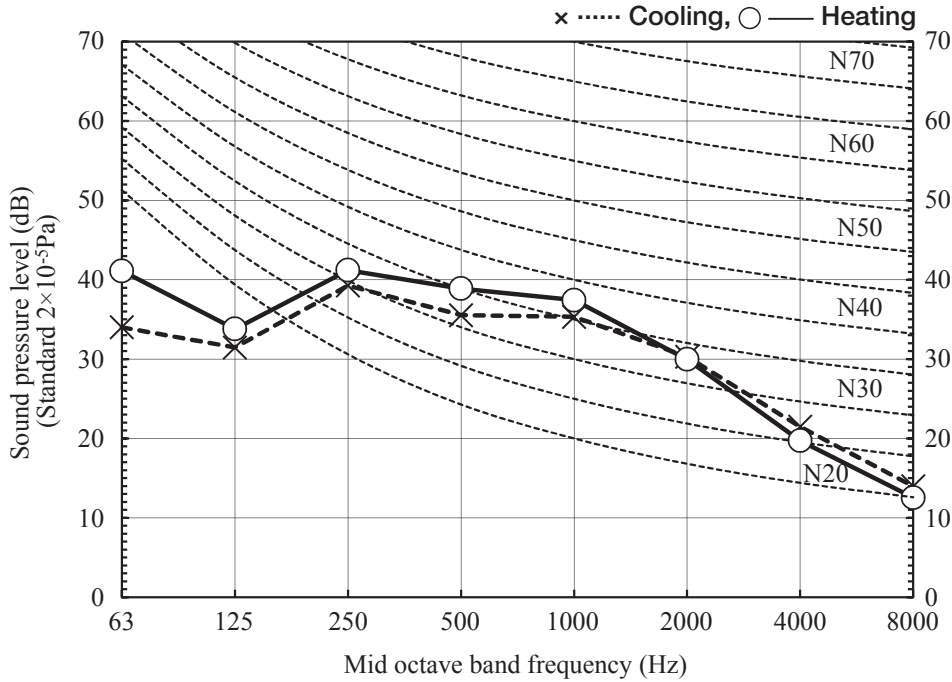

(Indoor Unit)

Model	DXK15Z6-S	
Noise Level	Cooling	24 dB(A)
	Heating	30 dB(A)

MODE	Lo
------	----

● Mike position

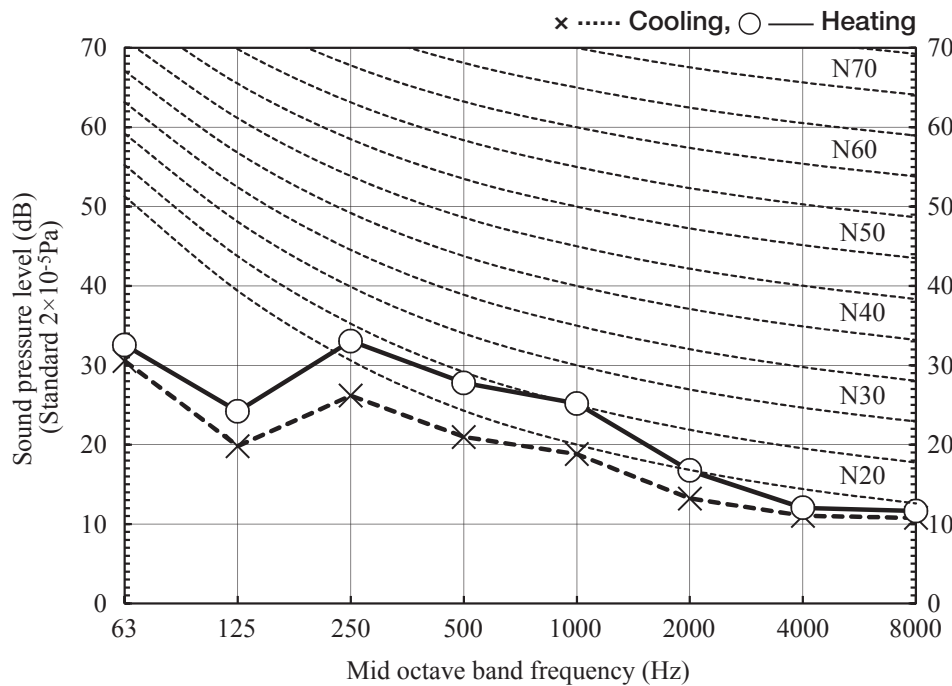
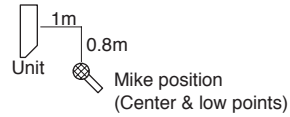

5. PIPING SYSTEM

Models DXK09Z6-S, 12Z6-S

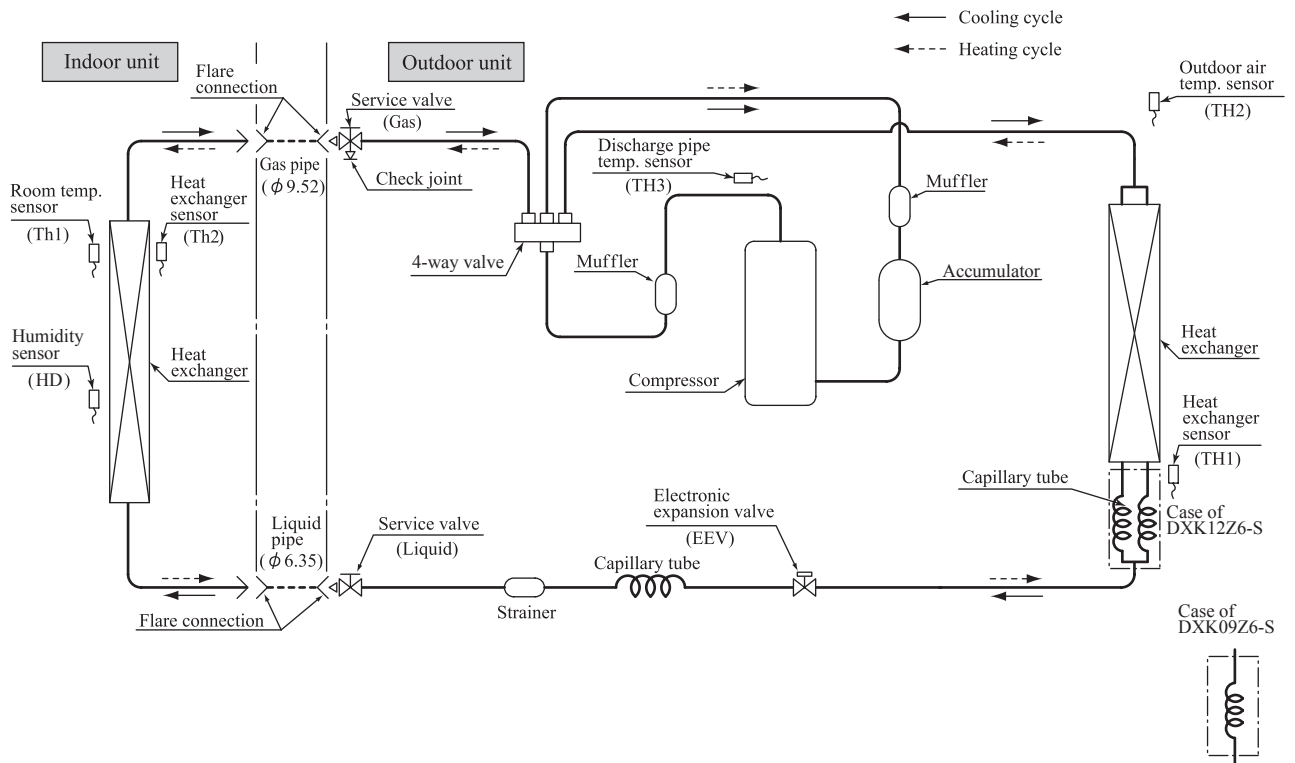

Model DXK15Z6-S

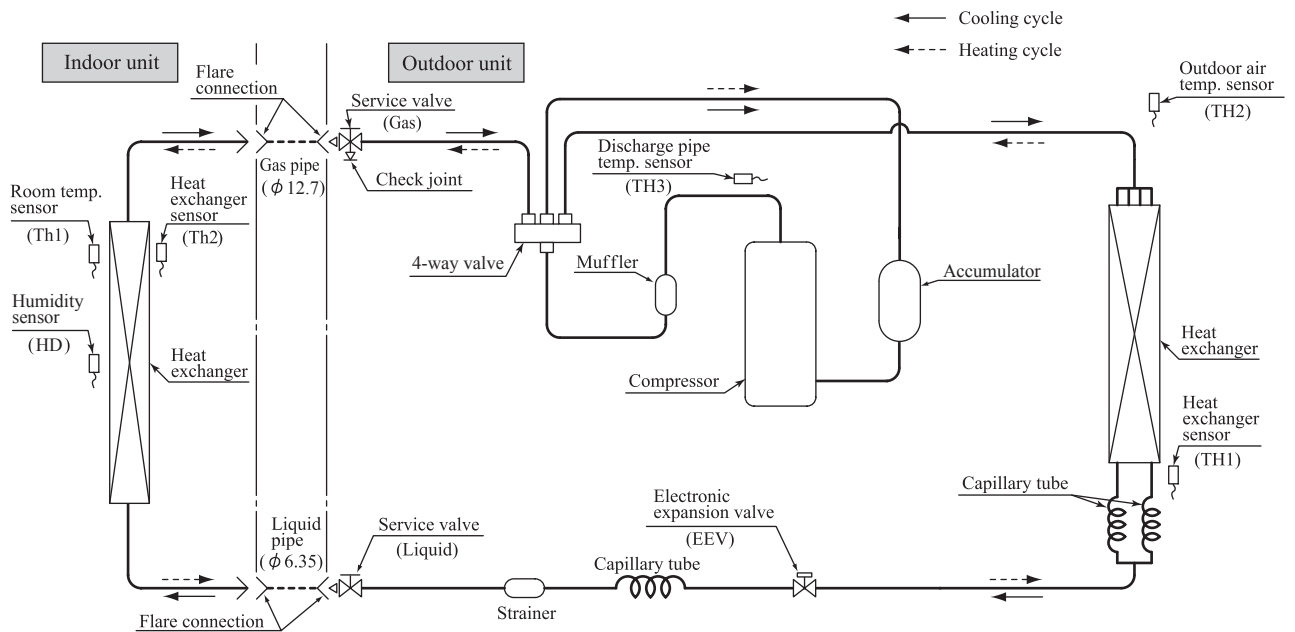

6. RANGE OF USAGE & LIMITATIONS

Item	Model	DXK09Z6-S, 12Z6-S	DXK15Z6-S
Indoor return air temperature (Upper, lower limits)		Cooling operation : Approximately 18 to 32°C DB Heating operation : Approximately 10 to 30°C DB (Refer to the selection chart)	
Outdoor air temperature (Upper, lower limits)		Cooling operation : Approximately -15 to 46°C DB Heating operation : Approximately -15 to 24°C DB (Refer to the selection chart)	
Refrigerant line (one way) length		Max. 15m	Max. 25m
Vertical height difference between outdoor unit and indoor unit		Max. 10m (Outdoor unit is higher) Max. 10m (Outdoor unit is lower)	Max. 15m (Outdoor unit is higher) Max. 15m (Outdoor unit is lower)
Power source voltage		Rating ±10%	
Voltage at starting		Min. 85% of rating	
Frequency of ON-OFF cycle		Max. 4 times/h (Inching prevention 10 minutes)	Max. 7 times/h (Inching prevention 5 minutes)
ON and OFF interval		Min. 3 minutes	

Selection chart

Correct the cooling and heating capacity in accordance with the conditions as follows. The net cooling and heating capacity can be obtained in the following way.

Net capacity = Capacity shown on specification × Correction factors as follows.

(1) Coefficient of cooling and heating capacity in relation to temperatures

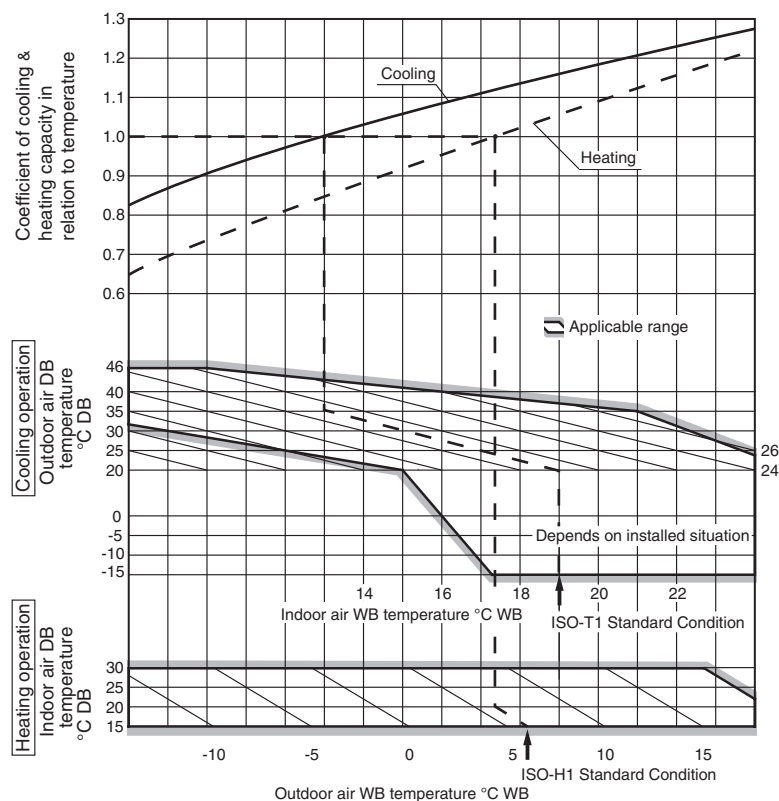

(2) Correction of cooling and heating capacity in relation to one way length of refrigerant piping

It is necessary to correct the cooling and heating capacity in relation to the one way piping length between the indoor and outdoor units.

Piping length [m]	7	10	15	20	25	30
Cooling	1.0	0.99	0.975	0.965	0.95	0.935
Heating	1.0	1.0	1.0	1.0	1.0	1.0

(3) Correction relative to frosting on outdoor heat exchanger during heating

In additions to the foregoing corrections (1), (2) the heating capacity needs to be adjusted also with respect to the frosting on the outdoor heat exchanger.

Air inlet temperature of outdoor unit in °CWB	-15	-10	-9	-7	-5	-3	-1	1	3	5 or more
Adjustment coefficient	0.95	0.95	0.94	0.93	0.91	0.88	0.86	0.87	0.92	1.00

How to obtain the cooling and heating capacity

Example : The net cooling capacity of the model DXK12Z6-S with the piping length of 15m, indoor wet-bulb temperature at 19.0°C and outdoor dry-bulb temperature 35°C is

$$\text{Net cooling capacity} = \underbrace{3.2}_{\substack{\uparrow \\ \text{DXK12Z6-S}}} \times \underbrace{0.975}_{\substack{\uparrow \\ \text{Length 15m}}} \times \underbrace{1.0}_{\substack{\uparrow \\ \text{Factor by air temperatures}}} \doteq 3.1\text{kW}$$

7. CAPACITY TABLES

Model DXK09Z6-S Cooling mode (kW)

Air flow	Outdoor air temperature	Indoor air temperature													
		21°CDB		23°CDB		26°CDB		27°CDB		28°CDB		31°CDB		33°CDB	
		TC	SHC	TC	SHC	TC	SHC	TC	SHC	TC	SHC	TC	SHC	TC	SHC
Hi 10.0 (m ³ /min)	10	2.82	2.35	2.95	2.31	3.06	2.41	3.11	2.38	3.16	2.35	3.26	2.44	3.34	2.38
	12	2.77	2.32	2.90	2.29	3.01	2.39	3.07	2.36	3.12	2.34	3.22	2.43	3.31	2.37
	14	2.71	2.29	2.85	2.26	2.97	2.37	3.03	2.35	3.08	2.32	3.18	2.42	3.28	2.36
	16	2.66	2.27	2.80	2.24	2.92	2.36	2.98	2.33	3.04	2.31	3.15	2.41	3.24	2.35
	18	2.60	2.25	2.74	2.22	2.88	2.34	2.94	2.32	2.99	2.29	3.11	2.40	3.20	2.33
	20	2.55	2.22	2.68	2.19	2.83	2.32	2.89	2.30	2.95	2.28	3.07	2.38	3.17	2.32
	22	2.49	2.19	2.63	2.17	2.78	2.30	2.84	2.28	2.90	2.26	3.02	2.36	3.13	2.31
	24	2.43	2.16	2.57	2.14	2.72	2.28	2.80	2.26	2.85	2.24	2.98	2.35	3.08	2.30
	26	2.37	2.14	2.51	2.11	2.67	2.25	2.74	2.24	2.80	2.22	2.93	2.33	3.04	2.28
	28	2.31	2.11	2.44	2.09	2.61	2.23	2.69	2.22	2.75	2.20	2.89	2.32	3.00	2.27
	30	2.24	2.08	2.38	2.06	2.56	2.21	2.64	2.20	2.70	2.18	2.84	2.30	2.95	2.25
	32	2.18	2.05	2.31	2.03	2.50	2.18	2.58	2.18	2.64	2.16	2.79	2.28	2.90	2.24
	34	2.11	2.00	2.25	2.00	2.44	2.16	2.53	2.16	2.59	2.14	2.74	2.27	2.85	2.22
	35	2.08	1.97	2.21	1.99	2.41	2.15	2.50	2.15	2.56	2.13	2.71	2.26	2.83	2.22
	36	2.04	1.94	2.18	1.97	2.38	2.14	2.47	2.14	2.53	2.12	2.69	2.25	2.80	2.21
	38	1.97	1.87	2.11	1.94	2.32	2.11	2.41	2.11	2.47	2.10	2.63	2.23	2.75	2.19
	40	1.90	1.81	2.03	1.91	2.25	2.09	2.35	2.09	2.41	2.08	2.58	2.21	2.70	2.17
	43	1.79	1.70	1.92	1.83	2.15	2.04	2.26	2.05	2.32	2.04	2.49	2.18	2.61	2.15
	46	1.68	1.59	1.81	1.72	2.05	1.95	2.16	2.02	2.22	2.00	2.40	2.15	2.53	2.12

Heating mode (HC) (kW)

Air flow	Outdoor air temperature	Indoor air temperature				
		16°CDB	18°CDB	20°CDB	22°CDB	24°CDB
Hi 9.5 (m ³ /min)	-15°CWB	1.72	1.69	1.65	1.61	1.58
	-10°CWB	1.95	1.91	1.89	1.84	1.80
	-5°CWB	2.11	2.08	2.04	2.02	1.98
	0°CWB	2.21	2.18	2.14	2.12	2.09
	5°CWB	2.82	2.79	2.77	2.72	2.68
	6°CWB	2.87	2.83	2.80	2.76	2.73
	10°CWB	3.04	3.02	3.00	2.96	2.93
	15°CWB	3.31	3.28	3.26	3.23	3.20
20°CWB	3.56	3.53	3.52	3.48	3.45	

Model DXK12Z6-S Cooling mode (kW)

Air flow	Outdoor air temperature	Indoor air temperature													
		21°CDB		23°CDB		26°CDB		27°CDB		28°CDB		31°CDB		33°CDB	
		TC	SHC	TC	SHC	TC	SHC	TC	SHC	TC	SHC	TC	SHC	TC	SHC
Hi 9.5 (m ³ /min)	10	3.61	2.75	3.77	2.70	3.91	2.80	3.98	2.76	4.05	2.72	4.17	2.79	4.28	2.70
	12	3.54	2.72	3.71	2.67	3.86	2.77	3.93	2.73	4.00	2.70	4.12	2.77	4.24	2.68
	14	3.47	2.69	3.65	2.64	3.80	2.74	3.87	2.71	3.94	2.67	4.08	2.75	4.19	2.67
	16	3.40	2.65	3.58	2.61	3.74	2.72	3.82	2.68	3.89	2.64	4.03	2.74	4.15	2.65
	18	3.33	2.61	3.51	2.57	3.68	2.68	3.76	2.66	3.83	2.62	3.98	2.71	4.10	2.64
	20	3.26	2.58	3.44	2.54	3.62	2.66	3.70	2.63	3.78	2.60	3.92	2.69	4.05	2.61
	22	3.19	2.54	3.36	2.51	3.55	2.63	3.64	2.61	3.71	2.58	3.87	2.68	4.00	2.59
	24	3.11	2.50	3.29	2.47	3.49	2.60	3.58	2.58	3.65	2.56	3.81	2.64	3.95	2.58
	26	3.03	2.46	3.21	2.43	3.42	2.57	3.51	2.55	3.59	2.53	3.76	2.62	3.89	2.56
	28	2.95	2.42	3.13	2.39	3.35	2.54	3.45	2.53	3.52	2.50	3.70	2.61	3.84	2.55
	30	2.87	2.38	3.05	2.35	3.27	2.51	3.38	2.50	3.45	2.47	3.64	2.59	3.78	2.52
	32	2.79	2.34	2.96	2.32	3.20	2.48	3.31	2.47	3.38	2.45	3.57	2.56	3.72	2.51
	34	2.70	2.30	2.88	2.28	3.12	2.45	3.24	2.44	3.31	2.42	3.51	2.54	3.65	2.48
	35	2.66	2.27	2.83	2.26	3.08	2.43	3.20	2.43	3.28	2.40	3.47	2.52	3.62	2.47
	36	2.61	2.25	2.79	2.24	3.04	2.41	3.16	2.41	3.24	2.39	3.44	2.51	3.59	2.46
	38	2.52	2.21	2.70	2.20	2.96	2.38	3.09	2.38	3.16	2.36	3.37	2.49	3.52	2.44
	40	2.43	2.17	2.60	2.16	2.88	2.33	3.01	2.35	3.08	2.33	3.30	2.46	3.45	2.42
	43	2.29	2.10	2.46	2.10	2.75	2.29	2.89	2.29	2.96	2.27	3.19	2.43	3.35	2.38
	46	2.15	2.03	2.31	2.03	2.62	2.24	2.77	2.25	2.84	2.23	3.08	2.38	3.23	2.35

Heating mode (HC) (kW)

Air flow	Outdoor air temperature	Indoor air temperature				
		16°CDB	18°CDB	20°CDB	22°CDB	24°CDB
Hi 9.6 (m ³ /min)	-15°CWB	2.21	2.17	2.12	2.07	2.03
	-10°CWB	2.51	2.46	2.43	2.37	2.32
	-5°CWB	2.71	2.68	2.62	2.59	2.55
	0°CWB	2.85	2.80	2.76	2.72	2.68
	5°CWB	3.63	3.58	3.56	3.49	3.44
	6°CWB	3.68	3.64	3.60	3.55	3.51
	10°CWB	3.91	3.88	3.85	3.80	3.76
	15°CWB	4.26	4.22	4.19	4.15	4.11
20°CWB	4.58	4.54	4.52	4.47	4.43	

Model DXK15Z6-S Cooling mode (kW)

Air flow	Outdoor air temperature	Indoor air temperature													
		21°CDB		23°CDB		26°CDB		27°CDB		28°CDB		31°CDB		33°CDB	
		TC	SHC	TC	SHC	TC	SHC	TC	SHC	TC	SHC	TC	SHC	TC	SHC
Hi 9.0 (m ³ /min)	10	5.07	3.57	5.31	3.52	5.50	3.58	5.59	3.53	5.69	3.47	5.86	3.50	6.02	3.36
	12	4.98	3.52	5.22	3.47	5.42	3.54	5.52	3.49	5.62	3.43	5.80	3.47	5.96	3.34
	14	4.88	3.47	5.13	3.42	5.34	3.50	5.45	3.45	5.55	3.40	5.73	3.43	5.90	3.31
	16	4.79	3.41	5.03	3.37	5.26	3.45	5.37	3.41	5.47	3.36	5.66	3.41	5.83	3.29
	18	4.69	3.35	4.93	3.31	5.18	3.41	5.29	3.37	5.39	3.32	5.59	3.38	5.77	3.26
	20	4.59	3.30	4.83	3.26	5.09	3.36	5.20	3.32	5.31	3.28	5.52	3.34	5.70	3.23
	22	4.48	3.23	4.73	3.20	5.00	3.31	5.12	3.28	5.22	3.24	5.44	3.31	5.63	3.20
	24	4.37	3.18	4.62	3.14	4.90	3.27	5.03	3.24	5.14	3.20	5.36	3.27	5.55	3.17
	26	4.26	3.11	4.51	3.08	4.80	3.22	4.94	3.20	5.05	3.16	5.28	3.24	5.48	3.14
	28	4.15	3.05	4.40	3.02	4.70	3.17	4.85	3.15	4.95	3.12	5.20	3.20	5.40	3.10
	30	4.04	2.98	4.28	2.96	4.60	3.12	4.75	3.11	4.86	3.07	5.11	3.16	5.31	3.08
	32	3.92	2.92	4.16	2.90	4.50	3.06	4.65	3.06	4.76	3.02	5.02	3.13	5.23	3.04
	34	3.80	2.85	4.04	2.84	4.39	3.02	4.55	3.01	4.66	2.98	4.93	3.09	5.14	3.01
	35	3.74	2.82	3.98	2.80	4.34	2.99	4.50	2.99	4.61	2.96	4.88	3.07	5.09	3.00
	36	3.67	2.79	3.92	2.78	4.28	2.96	4.45	2.96	4.55	2.93	4.84	3.05	5.05	2.98
	38	3.55	2.72	3.79	2.71	4.17	2.91	4.34	2.92	4.45	2.89	4.74	3.01	4.95	2.94
	40	3.42	2.65	3.66	2.64	4.05	2.85	4.23	2.86	4.34	2.84	4.64	2.97	4.85	2.91
	43	3.22	2.55	3.46	2.55	3.87	2.77	4.06	2.79	4.17	2.76	4.49	2.91	4.70	2.85
	46	3.02	2.45	3.25	2.45	3.69	2.68	3.89	2.71	3.99	2.69	4.33	2.84	4.55	2.78

Heating mode (HC) (kW)

Air flow	Outdoor air temperature	Indoor air temperature				
		16°CDB	18°CDB	20°CDB	22°CDB	24°CDB
Hi 12.0 (m ³ /min)	-15°CWB	3.08	3.01	2.94	2.88	2.81
	-10°CWB	3.48	3.42	3.37	3.29	3.22
	-5°CWB	3.77	3.72	3.64	3.60	3.54
	0°CWB	3.95	3.89	3.83	3.78	3.73
	5°CWB	5.04	4.98	4.95	4.85	4.78
	6°CWB	5.12	5.06	5.00	4.94	4.88
	10°CWB	5.44	5.38	5.35	5.28	5.23
	15°CWB	5.92	5.87	5.82	5.76	5.71
20°CWB	6.36	6.31	6.28	6.21	6.16	

Notes(1) These data show average statuses.
 Depending on the system control, there may be ranges where the operation is not conducted continuously.
 These data show the case where the operation frequency of a compressor is fixed.
 (2) Capacities are based on the following conditions.
 Corresponding refrigerant piping length :5m
 Level difference of Zero.
 (3) Symbols are as follows.
 TC : Total cooling capacity (kW)
 SHC : Sensible heat capacity (kW)
 HC : Heating capacity (kW)

8. APPLICATION DATA

Models DXK09Z6-S, 12Z6-S, 15Z6-S

RLC012A100

Model DXK09, 12, 15Z6-S
R410A REFRIGERANT USED

SAFETY PRECAUTIONS

- Before installation, read the "SAFETY PRECAUTIONS" carefully and strictly follow it during the installation.
- The precautionary items mentioned below are distinguished into two levels, **WARNING** and **CAUTION**.
- **WARNING** indicates a potentially hazardous situation which, if not avoided, can result in serious consequences such as death or severe injury.
- **CAUTION** indicates a potentially hazardous situation which, if not avoided, can result in personal injury or property damage.

Both mention the important items to protect your health and safety. Therefore, strictly follow them by any means.

WARNING

- **Be sure to use only for residential purpose.**
If this unit is installed in inferior environment such as machine shop, vehicle (like ship), warehouse, etc., it can malfunction.
- **Installation must be carried out by the qualified installer completely in accordance with the installation manual.**
Installation by non qualified person or incorrect installation can cause serious troubles such as water leak, electric shock, fire and personal injury.
- **Be sure to wear protective goggles and gloves while performing installation work.**
Improper safety measures can result in personal injury.
- **Use the original accessories and the specified components for the installation.**
Using parts other than those prescribed may cause water leak, electric shock, fire and personal injury.
- **Do not install the unit near the location where leakage of flammable gases can occur.**
If leaked gases accumulate around the unit, it can cause fire resulting in property damage and personal injury.
- **When installing the unit in small rooms, make sure that refrigerant density does not exceed the limit (Reference: ISO5149) in the event of leakage.**
If refrigerant density exceeds the limit, consult the dealer and install the ventilation system.
Otherwise lack of oxygen can occur resulting in serious accident.
- **Install the unit in a location where unit will remain stable, horizontal and free of any vibration transmission.**
Unsuitable installation location can cause the unit to fall resulting in material damage and personal injury.
- **Do not run the unit with removed panels or protections.**
Touching rotating equipments, hot surfaces or high voltage parts can cause personal injury due to entrapment, burn or electric shock.
- **This unit is designed specifically for R410A.**
Using any other refrigerant can cause unit failure and personal injury.
- **Do not vent R410A into atmosphere.**
R410A is a fluorinated greenhouse gas with a Global Warming Potential(GWP)=2088.
- **Make sure that no air enters the refrigerant circuit when the unit is installed and removed.**
If air enters the refrigerant circuit, the pressure in the refrigerant circuit will become too high, which can cause burst and personal injury.
- **Be sure to use the prescribed pipes, flare nuts and tools for R410A.**
Using existing parts (for R22 or R407C) can cause refrigerant circuit burst resulting in unit failure and personal injury.
- **Be sure to connect both liquid and gas connecting pipes properly before operating the compressor. Do not open the liquid and gas service valves before completing piping work, and evacuation.**
If the compressor is operated when connecting pipes are not connected and service valves are open, air can be sucked into the refrigerant circuit which can cause anomalous high pressure resulting in burst or personal injury.
- **Be sure to tighten the flare nuts to specified torque using the torque wrench.**
Tightening flare nuts with excess torque can cause burst and refrigerant leakage after a long period.
- **During pump down work, be sure to stop the compressor before closing service valves and removing connecting pipes.**
If the connecting pipes are removed when the compressor is in operation and service valves are open, air can be sucked into the refrigerant circuit which can cause anomalous high pressure resulting in burst or personal injury.
- **In the event of refrigerant leakage during installation, be sure to ventilate the working area properly.**
If the refrigerant comes into contact with naked flames, poisonous gases will be produced.
- **Electrical work must be carried out by the qualified electrician, strictly in accordance with national or regional electricity regulations.**
Incorrect installation can cause electric shock, fire or personal injury.
- **Make sure that earth leakage breaker and circuit breaker of appropriate capacities are installed.**
- **Be sure to confirm no operation problem on the equipment after completing the installation.** If unusual noise can be heard during the test run, consult the dealer.
- **Be sure to explain the operating methods as well as the maintenance methods of this equipment to the user according to the user's manual.**
- **Be sure to keep the installation manual together with user's manual at a place where it is easily accessible to the user any time.** Moreover, ask the user to hand the manuals to a new user, whenever required.
- **Be sure to tighten the cables securely in terminal block and relieve the cables properly to prevent overloading the terminal blocks.**
Loose connections or cable mountings can cause anomalous heat production or fire.
- **Do not process, splice or modify the power cable, or share the socket with other power plugs.**
Improper power cable or power plug can cause fire or electric shock due to poor connection, insufficient insulation or over-current.
- **Do not perform any change in protective device or its setup condition yourself.**
Changing protective device specifications can cause electric shock, fire or burst.
- **Be sure to clamp the cables properly so that they do not touch any internal component of the unit.**
If cables touch any internal component, it can cause overheating and fire.
- **Be sure to install service cover properly.**
Improper installation can cause electric shock or fire due to intrusion of dust or water.
- **Be sure to use the prescribed power and connecting cables for electrical work.**
Using improper cables can cause electric leak or fire.
- **This appliance must be connected to main power source by means of a circuit breaker or switch with a contact separation of at least 3mm.**
Improper electrical work can cause unit failure or personal injury.
- **When plugging this unit, a plug conforming to the standard IEC60884-1 must be used.**
Using improper plug can cause electric shock or fire.
- **Be sure to connect the power source cable with power source properly.**
Improper connection can cause intrusion of dust or water resulting in electric shock or fire.

⚠ CAUTION

<ul style="list-style-type: none"> • Take care when carrying the unit by hand. If the unit weight is more than 20kg, it must be carried by two or more persons. • Do not carry the unit by the plastic straps. Always use the carry handle. • Do not install the outdoor unit in a location where insects and small animals can inhabit. Insects and small animals can enter the electrical parts and cause damage resulting in fire or personal injury. Instruct the user to keep the surroundings clean. • If the outdoor unit is installed at height, make sure that there is enough space for installation, maintenance and service. Insufficient space can result in personal injury due to falling from the height. • Do not install the unit near the location where neighbours are bothered by noise or air generating from the unit. It can affect surrounding environment and cause a claim. • Do not install in the locations where unit is directly exposed to corrosive gases (like sulphide gas, chloride gas), sea breeze or salty atmosphere. 	<p>It can cause corrosion of heat exchanger and damage to plastic parts.</p> <ul style="list-style-type: none"> • Do not install the unit close to the equipments that generate electromagnetic waves and/or high-harmonic waves. Equipment such as inverters, standby generators, medical high frequency equipments and telecommunication equipments can affect the system, and cause malfunctions and breakdowns. The system can also affect medical equipment and telecommunication equipment, and obstruct its function or cause jamming. • Do not install the unit in the locations where: <ul style="list-style-type: none"> • There are heat sources nearby. • Unit is directly exposed to rain or sunlight. • There is any obstacle which can prevent smooth air circulation from inlet and outlet side of the unit. • Unit is directly exposed to oil mist and steam such as kitchen. • Chemical substances like ammonia (organic fertilizer), calcium chloride (snow melting agent) and acid (sulfurous acid etc.), which can harm the unit, will generate or accumulate. • Drain water can not be discharged properly. • TV set or radio receiver is placed within 1m. • Height above sea level is more than 1000m.
<p>It can cause performance degradation, corrosion and damage of components, unit malfunction and fire.</p> <ul style="list-style-type: none"> • Dispose of all packing materials properly. Packing materials contain nails and wood which can cause personal injury. • Keep the polybag away from children to avoid the risk of suffocation. • Do not put anything on the outdoor unit. Object may fall causing property damage or personal injury. • Do not touch the aluminum fin of the outdoor unit. Aluminium fin temperature is high during heating operation. Touching fin can cause burn. • Do not touch any refrigerant pipe with your hands when the system is in operation. During operation the refrigerant pipes become extremely hot or extremely cold depending on the operating condition. Touching pipes can cause personal injury like burn (hot/cold). • Install isolator or disconnect switch on the power source wiring in accordance with the local codes and regulations. The isolator should be locked in OFF state in accordance with EN60204-1. 	<p>It can cause performance degradation, corrosion and damage of components, unit malfunction and fire.</p> <ul style="list-style-type: none"> • Dispose of all packing materials properly. Packing materials contain nails and wood which can cause personal injury. • Keep the polybag away from children to avoid the risk of suffocation. • Do not put anything on the outdoor unit. Object may fall causing property damage or personal injury. • Do not touch the aluminum fin of the outdoor unit. Aluminium fin temperature is high during heating operation. Touching fin can cause burn. • Do not touch any refrigerant pipe with your hands when the system is in operation. During operation the refrigerant pipes become extremely hot or extremely cold depending on the operating condition. Touching pipes can cause personal injury like burn (hot/cold). • Install isolator or disconnect switch on the power source wiring in accordance with the local codes and regulations. The isolator should be locked in OFF state in accordance with EN60204-1.

ACCESSORIES AND TOOLS

Standard accessories (supplied with indoor unit)	
(1) Installation board	1pc (6) Batteries [R03 (AAA, Micro) 1.5V]
(2) Remote control	1pc (7) Air-cleaning filters (LMK model only)
(3) Remote control holder	1pc (8) Filter holders (LMK model only)
(4) Tapping screws (for installation board ø4 X 25mm)	5pcs (9) Insulation (ø486 50 X 100 I3)
(5) Wood screws (for remote control holder ø3.5 X 16mm)	2pcs
Standard accessories (supplied with outdoor unit)	
(1) Drain grommet	1pc
(2) Drain elbow	1pc

Locally procured parts	
(a) Sleeve (1pc)	
(b) Sealing plate (1pc)	
(c) Inclination plate (1pc)	
(d) Putty	
(e) Connecting cable	
(f) Drain hose (extension hose)	
(g) Piping cover (for insulation of connection piping)	
(h) Clamp and screw (for finishing work)	
(i) Anchor bolt(M10-M12)×4pcs	
(j) Electrical tape	
(k) Connecting pipe	
(l) Power cable	

Tools for installation work	
Plus headed driver	Hole core drill (65mm in diameter)
Knife	Wrench key (Hexagon) [4mm]
Saw	Flaring tool set*
Tape measure	Gas leak detector*
Torque wrench (14.0-62.0N·m (1.4-6.2kgf·m))	Pipe bender
Plier	Gauge for projection adjustment (Used when flare is made by using conventional flare tool)
Pipe cutter	
Spanner wrench	
Flare adjustment gauge	Charge hose *
Vacuum pump*	Vacuum pump adapter* (Anti-reverse flow type)
Gauge manifold *	

* Designed specifically for R410A

SELECTING OF INSTALLATION LOCATION

After getting customer's approval, select installation location according to following guidelines.

1. Indoor unit

- Where there is no obstruction to the air flow and where the cooled and heated air can be evenly distributed.
- A solid place where the unit or the wall will not vibrate.
- A place where there will be enough space for servicing. (Where space mentioned on the right side can be secured.)
- Where it is easy to conduct wiring and piping work.
- A place where unit is not directly exposed to sunlight or street light.
- A place where it can be easily drained.
- A place separated at least 1m away from the television or the radio. (To prevent interference to images and sounds.)
- A place where this unit is not affected by the high frequency equipment or electric equipment.
- Avoid installing this unit in place where there is much oil mist.
- A place where there is no electric equipment or household.
- Install the indoor unit on the wall where the height from the floor to the bottom of the unit is more than 180 cm.

2. Remote control

- A place where the air-conditioner can receive the signal surely during operating the remote control.
- A place where it is not affected by the TV, radio etc.
- Do not place where it is exposed to direct sunlight or near heat devices such as a stove.

3. Outdoor unit

- Select the suitable installation location where:
- Unit will be stable, horizontal and free of any vibration transmission.
 - There is no obstacle which can prevent smooth air circulation from inlet and outlet side of the unit.
 - There is enough space for service and maintenance of unit.
 - Neighbours are not bothered by noise or air generating from the unit.
 - Outlet air of the unit does not blow directly to animals or plants.
 - Drain water can be discharged properly.
 - There is no risk of flammable gas leakage.
 - There are no other heat sources nearby.
 - Unit is not directly exposed to rain or sunlight.
 - Unit is not directly exposed to oil mist and steam.
 - Chemical substances like ammonia (organic fertilizer), calcium chloride (snow melting agent) and acid (sulfurous acid etc.), which can harm the unit, will not generate or accumulate.
 - Unit is not directly exposed to corrosive gases (like sulphide gas, chloride gas), sea breeze or salty atmosphere.
 - No TV set or radio receiver is placed within 1m.
 - Unit is not affected by electromagnetic waves and/or high-harmonic waves generated by other equipments.
 - Strong wind does not blow against the unit outlet.
 - Heavy snowfalls do not occur (If installed, provide proper protection to avoid snow accumulation).
 - There must be 1 meter or larger space between the unit and the wall in at least 1 of the 4 sides. Walls surrounding the unit from 4 sides is not acceptable. The wall height on the outlet side should be 1200 mm or less. Refer to the following figure and table for details.

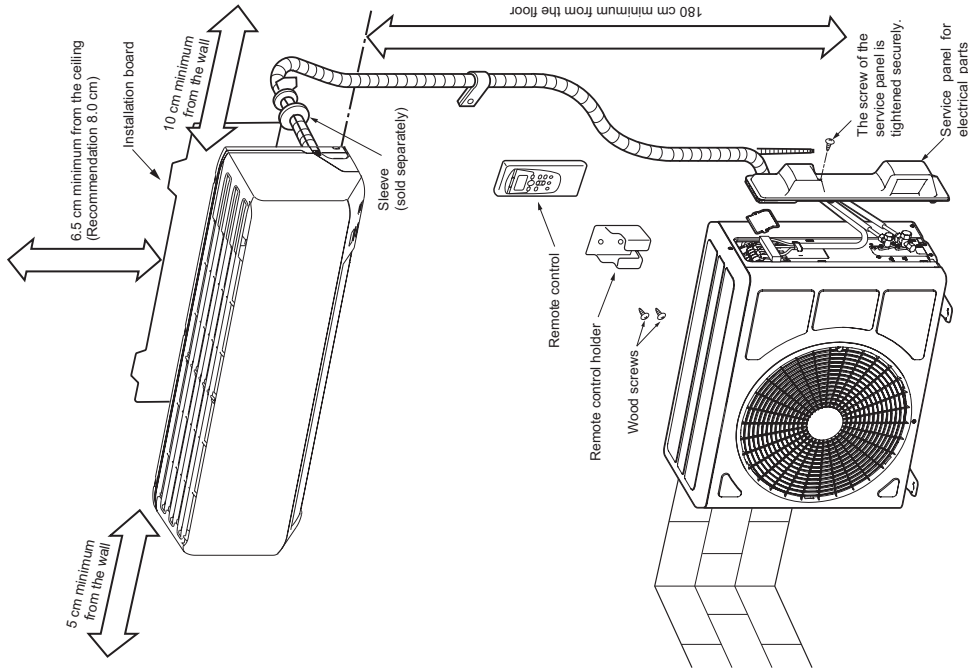

Limitation of the piping length

Model	DXK09	DXK12	DXK15
Total one way length	MAX. 15m	MAX. 15m	MAX. 25m
Vertical height difference	MAX. 10m	MAX. 10m	MAX. 15m
Additional refrigerant	Less than 10m : Not required More than 10m : 20g/m	Not required	Less than 15m : Not required More than 15m : 20g/m

	Installation space (mm)
L1	280 or more
L2	100 or more
L3	80 or more
L4	250 or more

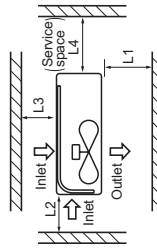

NOTE

When more than one unit are installed side by side, provide a 250mm or wider interval between them as a service space.

CAUTION

When more than one unit are installed in parallel directions, provide sufficient inlet space so that short-circuiting may not occur.

DRAIN PIPING WORK (if necessary)

Carry out drain piping work by using a drain elbow and a drain grommet supplied separately as accessories; if condensed water needs to be drained out.

- (1) Install drain elbow and drain grommet.
- (2) Seal around the drain elbow and drain grommet with putty or adequate caulking material.

Do not put a grommet on this hole.

This is a supplementary drain hole to discharge drain water, when a large amount of it is gathered.

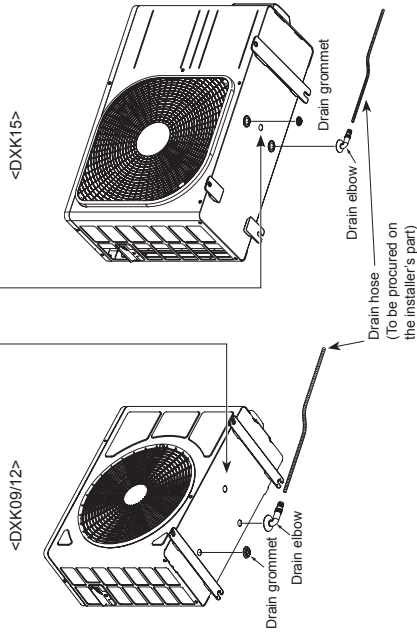

CAUTION

Do not use drain elbow and drain grommet if there is a possibility to have several consecutive days of sub zero temperature. (There is a risk of drain water freezing inside and blocking the drain.)

INSTALLING REMOTE CONTROL

Mount the batteries

- (1) Slide and take out the cover of backside.
- (2) Mount the batteries [R03 (AAA, Micro), *2 pieces] in the body properly.
(Fit the poles with the indication marks + & -)
- (3) Set the cover again.

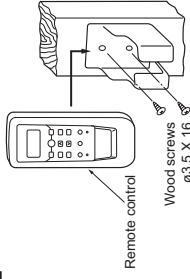

Installing remote control holder

- (1) Select the place where the unit can receive signals.
- (2) Fix the holder to pillar or wall with wood screws.

HOW TO REMOVE AND INSTALL FRONT PANEL

1. Removing

- (1) Remove the air inlet panel and the air filters.
- (2) Remove the 2 screws.
- (3) Remove the 3 upper latches and then front panel can be removed.

2. Installing

- (1) Cover the unit with the front panel and fix 3 upper latches.
- (2) Secure the front panel with the 2 screws.
- (3) Install the air inlet panel and the air filters.

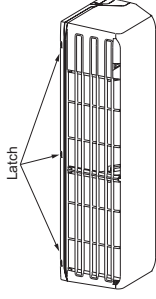

PUMP DOWN WORK

For the environmental protection, be sure to pump down when relocating or disposing of the unit. Pump down is the method of recovering refrigerant from the indoor unit to the outdoor unit before the connecting pipes are removed from the unit. When pump down is carried out, forced cooling operation is needed.

Forced cooling operation

- (1) Turn off the power source and turn it on again after 1 minute.
- (2) Press the ON/OFF button continuously for at least 5 seconds. Then operation will start.

For the detail of pump down, refer to the installation manual of outdoor unit.



1. INSTALLING INSTALLATION BOARD

- Installation board should be installed on the wall which can support the weight of the indoor unit.
- Adjustment of the installation board in the horizontal direction is to be conducted with five screws in a temporary tightened state.
- With the standard hole as a center, adjust the board and level it.

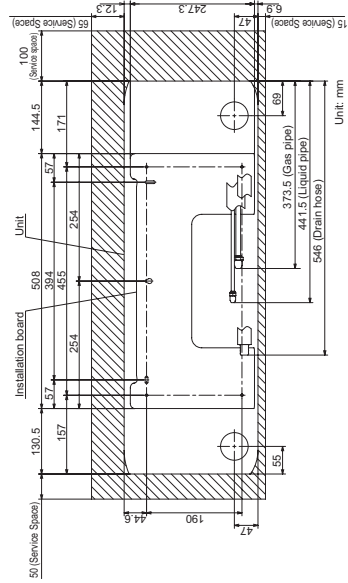
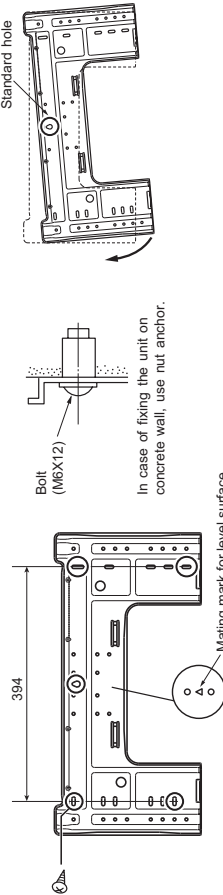

CAUTION

Improper adjustment of the installation board can cause water leakage.

2. DRILLING HOLE AND FIXTURE OF SLEEVE

When drilling the wall that contains a metal lath, wire lath or metal plate, be sure to use sealing plate, sleeve and inclination plate (Locally procured parts).

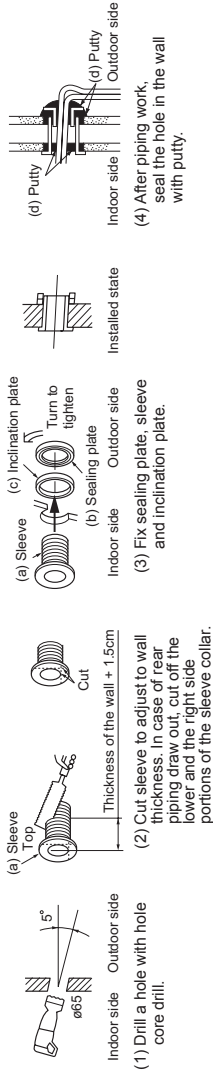

- WARNING**
Completely seal the hole in the wall with putty. If not sealed properly, dust, insects, small animals, and highly humid air may enter the room from outside, which could result in fire or other hazards.
- CAUTION**
Completely seal the hole in the wall with putty. If not sealed properly, furniture and other fixtures may be damaged by water leakage or condensation.

3. ELECTRICAL WIRING WORK

- Before installation, make sure that the power source complies with the air-conditioner's power specification.
- Carry out electrical wiring work according to following guidelines.

1. Preparing cable

- (1) Selecting cable
Select the connecting cable in accordance with the specifications mentioned below.
4-core * 1.5mm² conforming with 60245 IEC57
* 1 Earth wire is included (Yellow/Green).
- (2) Arrange each wire length as shown below.
Make sure that each wire is stripped 10mm from the end.
- (3) Attach round crimp-type terminal to each wire as shown in the below.
Select the size of round crimp-type terminal after considering the specifications of terminal block and wire diameter.
<Connecting cable (4 wires)>
<Power source cable (3 wires)>

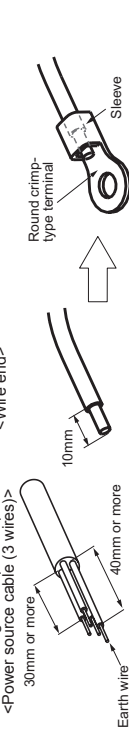

2. Connecting cable (Indoor)

- (1) Remove the lid.
- (2) Remove the terminal cover.
- (3) Remove the cable clamp.
- (4) Connect the connecting wire to the terminal block.
- (5) Fix the connecting cable by cable clamp.
- (6) Fix the terminal cover.
- (7) Fix the lid.

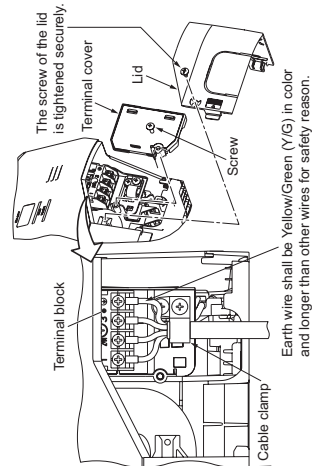

NOTE

Take care not to confuse the terminal numbers for indoor and outdoor connections.

WARNING

Incorrect wiring connection can cause malfunction or fire.

WARNING

- Make sure that all the electrical work is carried out in accordance with the national or regional electrical standards.
- Make sure that the earth leakage breaker and circuit breaker or appropriate capacities are installed (Refer to the table given below).
- Do not turn on the power until the electrical work is completed.
- Do not use a condensate capacitor for power factor improvement under any circumstances. (It does not improve power factor. Moreover, it can cause an abnormal overheat accident).

Breaker specifications

Model	Phase	Earth leakage breaker	Circuit breaker
DXK0912	Single phase	Leakage current: 30mA, 0.1sec or less	Over current: 16A
DXK15			Over current: 20A

Main fuse specification

Specification	Parts No.	Code on LABEL, WIRING
250V 15A	SSA564A136	F7

3. Connecting cable (Outdoor)

- (1) Remove the service cover.
- (2) Connect the cables according to the instructions and figures given below.
 - (a) Connect the earth wire of power source cable.
An earth wire must be connected before connecting the other wires of power source cable. Keep the earth wire longer than the remaining two wires (N and L) of power source cable.
 - (b) Connect the remaining two wires (N and L) of power source cable.
 - (c) Connect the wires of connecting cable. Make sure that for each wire, outdoor and indoor side terminal numbers match.
- (3) Fasten the cables properly with cable clamps so that no external force may work on terminal connections. Moreover, make sure that cables do not touch the piping, etc. When cables are connected, make sure that all electrical components within the electrical component box are free of loose connector coupling or terminal connection.

<Circuit diagram>

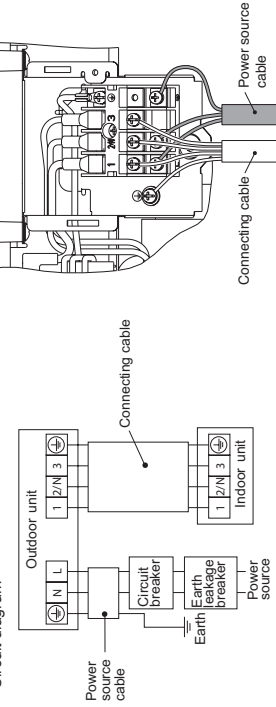

4. FORMING PIPING AND DRAIN HOSE

1. Forming piping

Piping is possible in the right, rear, downward, left, left rear or left downward direction.

NOTE

Sufficient care must be taken not to damage the panels when connecting pipes.

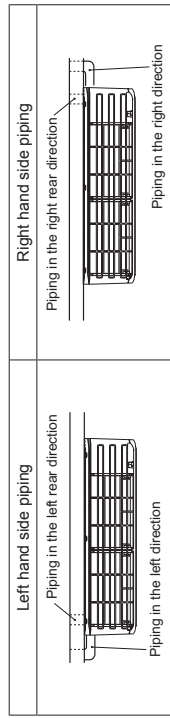
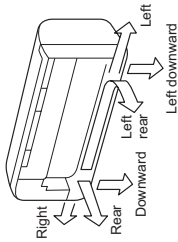

Forming of pipings.

- Hold the bottom of the piping and fix direction before stretching it and shaping it.
- Always tape the wiring with the piping.

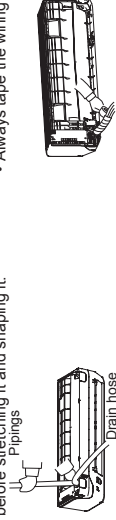

Taping of the exterior

- Tape only the portion that goes through the wall.
- Always tape the wiring with the piping.

2. Drain change procedures

- (1) Remove the screw and drain hose.
- (2) Remove the drain cap by hand or pliers.
- (3) Insert the drain cap which was removed at procedure (2) securely using a hexagonal wrench etc.
- (4) Install the drain hose and screw securely.

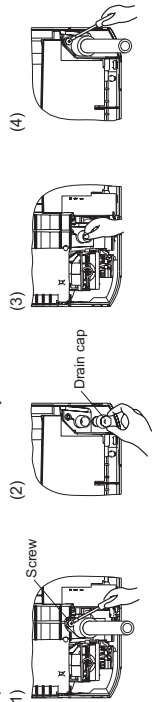

CAUTION

Incorrect installation of drain hose and cap can cause water leakage.

5. DRAINAGE WORK

- Arrange the drain hose in a downward angle.
- Avoid the following drain piping.

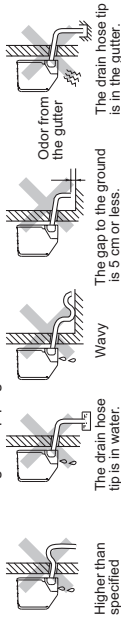

- Pour water to the drain pan located under the heat exchanger, and ensure that the water is discharged outdoor.
 - When extended drain hose is present inside the room, insulate it securely with heat insulator available in the market.
- Since this air-conditioner is designed to collect dew drops on the rear surface to the drain pan, do not install the connecting wire above the gutter.

CAUTION

Incorrect drainage work can cause water leakage.

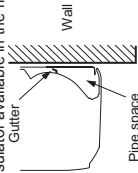

6. INSTALLING INDOOR UNIT

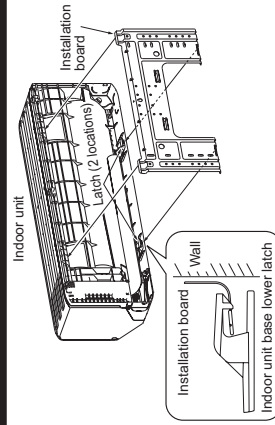

Installation steps

- (1) Pass the pipe through the hole in the wall, and hook the upper part of the indoor unit to the installation board.
- (2) Gently push the lower part to secure the unit.

- How to remove the indoor unit from the installation board
 - (1) Push up at the marked portion of the indoor unit base lower latch, and slightly pull it toward you (both right and left hand sides) (The indoor unit base lower latch can be removed from the installation board.)
 - (2) Push up the indoor unit upward so that it can be removed from the installation board.

The marked portion of the indoor unit base lower latch

7. CONNECTING PIPING WORK

1. Preparation of connecting pipe

1.1. Selecting connecting pipe

Select connecting pipe according to the following table.

	Model DXK09/12	Model DXK15
Gas pipe	ø9.52	ø12.7
Liquid pipe	ø6.35	ø6.35

- Pipe wall thickness must be greater than or equal to 0.8 mm.
- Pipe material must be O-type (Phosphorus deoxidized seamless copper pipe ICS 23.040.15, ICS 77.150.30).

1.2. Cutting connecting pipe

- (1) Cut the connecting pipe to the required length with pipe cutter.
- (2) Hold the pipe downward and remove the burrs. Make sure that no foreign material enters the pipe.
- (3) Cover the connecting pipe ends with the tape.

2. Piping work

2.1. Flaring pipe

- (1) Take out flare nuts from the service valves of indoor unit and engage them onto connecting pipes.
- (2) Flare the pipes according to table and figure shown below.
Flare dimensions for R410A are different from those for conventional refrigerant. Although it is recommended to use the flaring tools designed specifically for R410A, conventional flaring tools can also be used by adjusting the measurement of protrusion B with a flare adjustment gauge.

Copper pipe outer diameter	A	0	-0.4
ø6.35	9.1		
ø9.52	13.2		
ø12.7	16.6		

Copper pipe outer diameter	Rigid (clutch) type
ø6.35	R410A Conventional
ø9.52	0-0.5
ø12.7	1.0-1.5

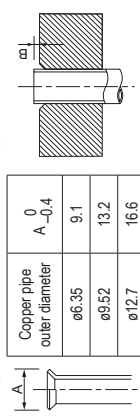

2.2. Connecting pipes

- (1) Connect pipes on both liquid and gas sides.
- (2) Tighten nuts to specified torque shown in the table below.

Service valve size (mm)	Tightening torque (N·m)
ø6.35 (1/4")	14-18
ø9.52 (3/8")	34-42
ø12.7 (1/2")	49-61

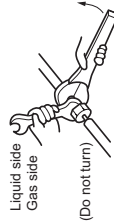

3. Heating and condensation prevention

- (1) Dress the connecting pipes (both liquid and gas pipes) with insulation to prevent it from heating and dew condensation.
Use the heat insulating material which can withstand 120°C or higher temperature. Make sure that insulation is wrapped tightly around the pipes and no gap is left between them.
- (2) Wrap the refrigerant pipings of indoor unit with indoor unit heat insulation using tape.
- (3) Cover the flare-connected joints (indoor side) with the indoor unit heat insulation and wrap it with an insulation pad (standard accessory provided with indoor unit).
- (4) Wrap the connecting pipes, connecting cable and drain hose with the tape.

- (1) Do not apply refrigerating machine oil to the flared surface. It can cause refrigerant leakage.
- (2) Do not apply excess torque to the flared nuts. The flared nuts may crack resulting in refrigerant leakage.

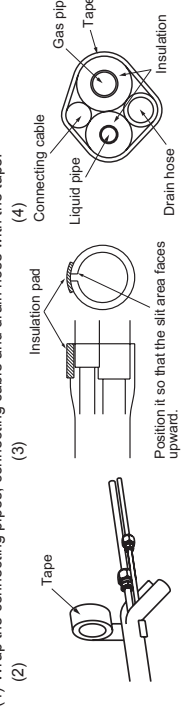

NOTE

Locations where relative humidity exceeds 70%, both liquid and gas pipes need to be dressed with 20mm or thicker heat insulation materials.

CAUTION

- Improper insulation can cause condensate(water) formation during cooling operation.
- Condensate can leak or drip causing damage to household property.
- Poor heat insulating capacity can cause pipe outer surface to reach high temperature during heating operation. It can cause cable deterioration and personal injury.

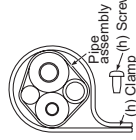

4. Finishing work

- (1) Make sure that the exterior portion of connecting pipes, connecting cable and drain hose is wrapped properly with tape. Shape the connecting pipes to match with the contours of the pipe assembly route.
- (2) Fix the pipe assembly with the wall using clamps and screws. Pipe assembly should be anchored every 1.5m or less to isolate the vibration.
- (3) Install the service cover securely. Water may enter the unit if service cover is not installed properly, resulting in unit malfunction and failure.

CAUTION

Make sure that the connecting pipes do not touch the components within the unit. If pipes touch the internal components, it may generate abnormal sounds and/or vibrations.

5. Evacuation

- (1) Connect vacuum pump to gauge manifold. Connect charge hose of gauge manifold to service port of outdoor unit.
- (2) Run the vacuum pump for at least one hour after the vacuum gauge shows -0.1MPa (-76cm Hg).
- (3) Confirm that the vacuum gauge indicator does not rise even if the system is left for 15 minutes or more. Vacuum gauge indicator will rise if the system has moisture left inside or has a leakage point. Check the system for the leakage point. If leakage point is found, repair it and return to (1) again.
- (4) Close the Handle Lo and stop the vacuum pump.
Keep this state for a few minutes to make sure that the compound pressure gauge pointer does not swing back.
- (5) Remove valve caps from liquid service valve and gas service valve.
- (6) Turn the liquid service valve's rod 90 degree counterclockwise with a hexagonal wrench key to open valve. Close it after 5 seconds, and check for gas leakage.
Using soapy water, check for gas leakage from indoor unit's flare and outdoor unit's flare and valve rods. Wipe off all the water after completing the check.
- (7) Disconnect charging hose from gas service valve's service port and fully open liquid and gas service valves. (Do not attempt to turn valve rod beyond its stop.)
- (8) Tighten service valve caps and service port cap to the specified torque shown in the table below.

Service valve size (mm)	Service valve cap tightening torque (N·m)	Service port cap tightening torque (N·m)
ø6.35 (1/4")	20-30	10-12
ø9.52 (3/8")	25-35	
ø12.7 (1/2")		

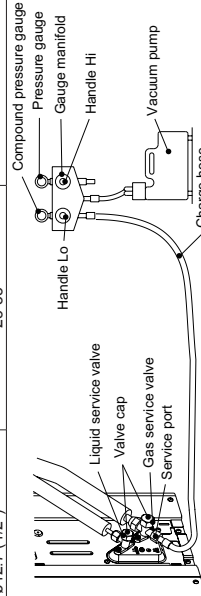

CAUTION

To prevent vacuum pump oil from entering into the refrigerant system, use a counterflow prevention adapter.

8. INSTALLATION CHECK AND TEST RUN

After finishing the installation work, check the following points again before turning on the power. Conduct a test run and ensure that the unit operates properly.
At the same time, explain to the customer how to use the unit and how to take care of the unit following the user's manual.

NOTE

During restart or change in operation mode, the unit will not start operating for approximately 3 minutes. This is to protect the unit and it is not malfunction.

Before test run

Before test run, check following points.

Power source voltage complies with the rated voltage of air-conditioner.	
Earth leakage breaker and circuit breaker are installed.	
Power cable and connecting cable are securely fixed to the terminal block.	
Both liquid and gas service valves are fully open.	
No gas leaks from the joints of the service valves.	
Indoor and outdoor side pipe joints have been insulated.	
Hole on the wall is completely sealed with putty.	
Drain hose and cap are installed properly.	
Screw of the lid is tightened securely.	

Test run

Check following points during test run.

Indoor unit receives signal of remote control.	
Air-conditioning operation is normal.	
There is no abnormal noise.	
Water drains out smoothly.	
Display of remote control is normal.	

After test run

Explain the operating and maintenance methods to the user according to the user's manual.	
Keep this installation manual together with user's manual.	

9. TECHNICAL INFORMATION

Model DXK09Z6-S

Information to identify the model(s) to which the information relates to:				If function includes heating: Indicate the heating season the information relates to. Indicated values should relate to one heating season at a time. Include at least the heating season 'Average'.			
Indoor unit model name		DXK09Z6-S		Outdoor unit model name		DXC09Z6-S	
Function(indicate if present)				Average(mandatory)			
cooling		Yes		Warmer(if designated)		Yes	
heating		Yes		Colder(if designated)		No	
Item				Item			
		symbol value unit				symbol value class	
Design load				Seasonal efficiency and energy efficiency class			
cooling		Pdesignc 2.50 kW		cooling		SEER 5.50 A	
heating / Average		Pdesignh 2.80 kW		heating / Average		SCOP/A 3.80 A	
heating / Warmer		Pdesignh 2.80 kW		heating / Warmer		SCOP/W 4.90 A++	
heating / Colder		Pdesignh - kW		heating / Colder		SCOP/C - -	
Declared capacity at outdoor temperature Tdesignh				Back up heating capacity at outdoor temperature Tdesignh			
heating / Average (-10°C)		Pdh 2.34 kW		heating / Average (-10°C)		elbu 0.46 kW	
heating / Warmer (2°C)		Pdh 2.80 kW		heating / Warmer (2°C)		elbu 0 kW	
heating / Colder (-22°C)		Pdh - kW		heating / Colder (-22°C)		elbu - kW	
Declared capacity for cooling, at indoor temperature 27(19)°C and outdoor temperature Tj				Declared energy efficiency ratio, at indoor temperature 27(19)°C and outdoor temperature Tj			
Tj=35°C		Pdc 2.50 kW		Tj=35°C		EERd 3.21 -	
Tj=30°C		Pdc 1.84 kW		Tj=30°C		EERd 4.85 -	
Tj=25°C		Pdc 1.29 kW		Tj=25°C		EERd 8.15 -	
Tj=20°C		Pdc 1.78 kW		Tj=20°C		EERd 8.13 -	
Declared capacity for heating / Average season, at indoor temperature 20°C and outdoor temperature Tj				Declared coefficient of performance / Average season, at indoor temperature 20°C and outdoor temperature Tj			
Tj=-7°C		Pdh 2.48 kW		Tj=-7°C		COPd 2.17 -	
Tj=2°C		Pdh 1.41 kW		Tj=2°C		COPd 3.85 -	
Tj=7°C		Pdh 0.97 kW		Tj=7°C		COPd 5.15 -	
Tj=12°C		Pdh 1.02 kW		Tj=12°C		COPd 6.22 -	
Tj=bivalent temperature		Pdh 2.48 kW		Tj=bivalent temperature		COPd 2.17 -	
Tj=operating limit		Pdh 2.10 kW		Tj=operating limit		COPd 1.97 -	
Declared capacity for heating / Warmer season, at indoor temperature 20°C and outdoor temperature Tj				Declared coefficient of performance / Warmer season, at indoor temperature 20°C and outdoor temperature Tj			
Tj=2°C		Pdh 2.80 kW		Tj=2°C		COPd 2.20 -	
Tj=7°C		Pdh 1.80 kW		Tj=7°C		COPd 4.80 -	
Tj=12°C		Pdh 1.02 kW		Tj=12°C		COPd 6.20 -	
Tj=bivalent temperature		Pdh 2.80 kW		Tj=bivalent temperature		COPd 2.20 -	
Tj=operating limit		Pdh 2.10 kW		Tj=operating limit		COPd 1.97 -	
Declared capacity for heating / Colder season, at indoor temperature 20°C and outdoor temperature Tj				Declared coefficient of performance / Colder season, at indoor temperature 20°C and outdoor temperature Tj			
Tj=-7°C		Pdh - kW		Tj=-7°C		COPd - -	
Tj=2°C		Pdh - kW		Tj=2°C		COPd - -	
Tj=7°C		Pdh - kW		Tj=7°C		COPd - -	
Tj=12°C		Pdh - kW		Tj=12°C		COPd - -	
Tj=bivalent temperature		Pdh - kW		Tj=bivalent temperature		COPd - -	
Tj=operating limit		Pdh - kW		Tj=operating limit		COPd - -	
Tj=-15°C		Pdh - kW		Tj=-15°C		COPd - -	
Bivalent temperature				Operating limit temperature			
heating / Average		Tbiv -7 °C		heating / Average		Tol -15 °C	
heating / Warmer		Tbiv 2 °C		heating / Warmer		Tol -15 °C	
heating / Colder		Tbiv - °C		heating / Colder		Tol - °C	
Cycling interval capacity				Cycling interval efficiency			
for cooling		Pcycc - kW		for cooling		EERcyc - -	
for heating		Pcyhc - kW		for heating		COPcyc - -	
Degradation coefficient				Degradation coefficient			
cooling		Cdc 0.25 -		heating		Cdh 0.25 -	
Electric power input in power modes other than 'active mode'				Annual electricity consumption			
off mode		Poff 6 W		cooling		Qce 160 kWh/a	
standby mode		Psb 6 W		heating / Average		Qhe 1033 kWh/a	
thermostat-off mode		Pto 23 W		heating / Warmer		Qhe 800 kWh/a	
crankcase heater mode		Pck 0 W		heating / colder		Qhe - kWh/a	
Capacity control(indicate one of three options)				Other items			
fixed		No		Sound power level(indoor)		Lwa 58 dB(A)	
staged		No		Sound power level(outdoor)		Lwa 58 dB(A)	
variable		Yes		Global warming potential		GWP 1975 kgCO2eq.	
				Rated air flow(indoor)		- 600 m3/h	
				Rated air flow(outdoor)		- 1560 m3/h	
Contact details for obtaining more information		Name and address of the manufacturer or of its authorised representative. Mitsubishi Heavy Industries Air-Conditioning Europe, Ltd. 5 The Square, Stockley Park, Uxbridge, Middlesex, UB11 1ET, United Kingdom					

Model DXK12Z6-S

Information to identify the model(s) to which the information relates to:		If function includes heating: Indicate the heating season the information relates to. Indicated values should relate to one heating season at a time. Include at least the heating season 'Average'.					
Indoor unit model name	DXK12Z6-S						
Outdoor unit model name	DXC12Z6-S						
Function(indicate if present)		Average(mandatory)					
cooling	Yes	Warmer(if designated)		Yes			
heating	Yes	Colder(if designated)		No			
Item	symbol	value	unit	Item	symbol	value	class
Design load				Seasonal efficiency and energy efficiency class			
cooling	Pdesignc	3.20	kW	cooling	SEER	6.15	A++
heating / Average	Pdesignh	3.00	kW	heating / Average	SCOP/A	4.00	A+
heating / Warmer	Pdesignh	3.30	kW	heating / Warmer	SCOP/W	5.30	A+++
heating / Colder	Pdesignh	-	kW	heating / Colder	SCOP/C	-	-
				unit			
Declared capacity at outdoor temperature Tdesignh				Back up heating capacity at outdoor temperature Tdesignh			
heating / Average (-10°C)	Pdh	2.54	kW	heating / Average (-10°C)	elbu	0.46	kW
heating / Warmer (2°C)	Pdh	3.30	kW	heating / Warmer (2°C)	elbu	0	kW
heating / Colder (-22°C)	Pdh	-	kW	heating / Colder (-22°C)	elbu	-	kW
Declared capacity for cooling, at indoor temperature 27(19)°C and outdoor temperature Tj				Declared energy efficiency ratio, at indoor temperature 27(19)°C and outdoor temperature Tj			
Tj=35°C	Pdc	3.20	kW	Tj=35°C	EERd	3.22	-
Tj=30°C	Pdc	2.36	kW	Tj=30°C	EERd	5.16	-
Tj=25°C	Pdc	1.52	kW	Tj=25°C	EERd	8.97	-
Tj=20°C	Pdc	1.86	kW	Tj=20°C	EERd	9.75	-
Declared capacity for heating / Average season, at indoor temperature 20°C and outdoor temperature Tj				Declared coefficient of performance / Average season, at indoor temperature 20°C and outdoor temperature Tj			
Tj=-7°C	Pdh	2.65	kW	Tj=-7°C	COPd	2.28	-
Tj=2°C	Pdh	1.62	kW	Tj=2°C	COPd	4.08	-
Tj=7°C	Pdh	1.04	kW	Tj=7°C	COPd	5.34	-
Tj=12°C	Pdh	1.07	kW	Tj=12°C	COPd	6.54	-
Tj=bivalent temperature	Pdh	2.65	kW	Tj=bivalent temperature	COPd	2.28	-
Tj=operating limit	Pdh	2.35	kW	Tj=operating limit	COPd	2.13	-
Declared capacity for heating / Warmer season, at indoor temperature 20°C and outdoor temperature Tj				Declared coefficient of performance / Warmer season, at indoor temperature 20°C and outdoor temperature Tj			
Tj=2°C	Pdh	3.30	kW	Tj=2°C	COPd	2.50	-
Tj=7°C	Pdh	2.12	kW	Tj=7°C	COPd	5.15	-
Tj=12°C	Pdh	1.08	kW	Tj=12°C	COPd	6.54	-
Tj=bivalent temperature	Pdh	3.30	kW	Tj=bivalent temperature	COPd	2.50	-
Tj=operating limit	Pdh	2.35	kW	Tj=operating limit	COPd	2.13	-
Declared capacity for heating / Colder season, at indoor temperature 20°C and outdoor temperature Tj				Declared coefficient of performance / Colder season, at indoor temperature 20°C and outdoor temperature Tj			
Tj=-7°C	Pdh	-	kW	Tj=-7°C	COPd	-	-
Tj=2°C	Pdh	-	kW	Tj=2°C	COPd	-	-
Tj=7°C	Pdh	-	kW	Tj=7°C	COPd	-	-
Tj=12°C	Pdh	-	kW	Tj=12°C	COPd	-	-
Tj=bivalent temperature	Pdh	-	kW	Tj=bivalent temperature	COPd	-	-
Tj=operating limit	Pdh	-	kW	Tj=operating limit	COPd	-	-
Tj=-15°C	Pdh	-	kW	Tj=-15°C	COPd	-	-
Bivalent temperature				Operating limit temperature			
heating / Average	Tbiv	-7	°C	heating / Average	Tol	-15	°C
heating / Warmer	Tbiv	2	°C	heating / Warmer	Tol	-15	°C
heating / Colder	Tbiv	-	°C	heating / Colder	Tol	-	°C
Cycling interval capacity				Cycling interval efficiency			
for cooling	Pcycc	-	kW	for cooling	EERcyc	-	-
for heating	Pcyh	-	kW	for heating	COPcyc	-	-
Degradation coefficient				Degradation coefficient			
cooling	Cdc	0.25	-	heating	Cdh	0.25	-
Electric power input in power modes other than 'active mode'				Annual electricity consumption			
off mode	Poff	6	W	cooling	Qce	183	kWh/a
standby mode	Psb	6	W	heating / Average	Qhe	1052	kWh/a
thermostat-off mode	Pto	25	W	heating / Warmer	Qhe	873	kWh/a
crankcase heater mode	Pck	0	W	heating / colder	Qhe	-	kWh/a
Capacity control(indicate one of three options)				Other items			
fixed		No		Sound power level(indoor)	Lwa	59	dB(A)
staged		No		Sound power level(outdoor)	Lwa	60	dB(A)
variable		Yes		Global warming potential	GWP	1975	kgCO2eq
				Rated air flow(indoor)	-	570	m3/h
				Rated air flow(outdoor)	-	1524	m3/h
Contact details for obtaining more information	Name and address of the manufacturer or of its authorised representative. Mitsubishi Heavy Industries Air-Conditioning Europe, Ltd. 5 The Square, Stockley Park, Uxbridge, Middlesex, UB11 1ET, United Kingdom						

Model DXK15Z6-S

Information to identify the model(s) to which the information relates to: Indoor unit model name DXK15Z6-S Outdoor unit model name DXC15Z6-S		If function includes heating: Indicate the heating season the information relates to. Indicated values should relate to one heating season at a time. Include at least the heating season 'Average'.	
Function(indicate if present) cooling Yes heating Yes		Average(mandatory) Yes Warmer(if designated) Yes Colder(if designated) No	
Item	symbol	value	unit
Design load		Seasonal efficiency and energy efficiency class	
cooling	Pdesignc	4.50	kW
heating / Average	Pdesignh	3.80	kW
heating / Warmer	Pdesignh	4.40	kW
heating / Colder	Pdesignh	-	kW
Declared capacity at outdoor temperature Tdesignh		Back up heating capacity at outdoor temperature Tdesignh	
heating / Average (-10°C)	Pdh	3.35	kW
heating / Warmer (2°C)	Pdh	4.40	kW
heating / Colder (-22°C)	Pdh	-	kW
Declared capacity for cooling, at indoor temperature 27(19)°C and outdoor temperature Tj		Declared energy efficiency ratio, at indoor temperature 27(19)°C and outdoor temperature Tj	
Tj=35°C	Pdc	4.50	kW
Tj=30°C	Pdc	3.32	kW
Tj=25°C	Pdc	2.13	kW
Tj=20°C	Pdc	2.68	kW
Declared capacity for heating / Average season, at indoor temperature 20°C and outdoor temperature Tj		Declared coefficient of performance / Average season, at indoor temperature 20°C and outdoor temperature Tj	
Tj=-7°C	Pdh	3.36	kW
Tj=2°C	Pdh	2.05	kW
Tj=7°C	Pdh	1.32	kW
Tj=12°C	Pdh	1.35	kW
Tj=bivalent temperature	Pdh	3.36	kW
Tj=operating limit	Pdh	3.32	kW
Declared capacity for heating / Warmer season, at indoor temperature 20°C and outdoor temperature Tj		Declared coefficient of performance / Warmer season, at indoor temperature 20°C and outdoor temperature Tj	
Tj=2°C	Pdh	4.40	kW
Tj=7°C	Pdh	2.80	kW
Tj=12°C	Pdh	1.35	kW
Tj=bivalent temperature	Pdh	4.40	kW
Tj=operating limit	Pdh	3.32	kW
Declared capacity for heating / Colder season, at indoor temperature 20°C and outdoor temperature Tj		Declared coefficient of performance / Colder season, at indoor temperature 20°C and outdoor temperature Tj	
Tj=-7°C	Pdh	-	kW
Tj=2°C	Pdh	-	kW
Tj=7°C	Pdh	-	kW
Tj=12°C	Pdh	-	kW
Tj=bivalent temperature	Pdh	-	kW
Tj=operating limit	Pdh	-	kW
Tj=-15°C	Pdh	-	kW
Bivalent temperature		Operating limit temperature	
heating / Average	Tbiv	-7	°C
heating / Warmer	Tbiv	2	°C
heating / Colder	Tbiv	-	°C
Cycling interval capacity		Cycling interval efficiency	
for cooling	Pcycc	-	kW
for heating	Pcyh	-	kW
Degradation coefficient		Degradation coefficient	
cooling	Cdc	0.25	-
Electric power input in power modes other than 'active mode'		Annual electricity consumption	
off mode	Poff	7	W
standby mode	Psb	7	W
thermostat-off mode	Pto	31	W
crankcase heater mode	Pck	0	W
Capacity control(indicate one of three options)		Other items	
fixed		Lwa	58 dB(A)
staged	No	Lwa	63 dB(A)
variable	Yes	GWP	1975 kgCO2eq
Contact details for obtaining more information		Rated air flow(indoor) - 540 m3/h	
Name and address of the manufacturer or of its authorised representative. Mitsubishi Heavy Industries Air-Conditioning Europe, Ltd. 5 The Square, Stockley Park, Uxbridge, Middlesex, UB11 1ET, United Kingdom		Rated air flow(outdoor) - 2130 m3/h	

INVERTER WALL MOUNTED TYPE RESIDENTIAL AIR-CONDITIONERS



MITSUBISHI HEAVY INDUSTRIES THERMAL SYSTEMS, LTD.

16-5 Konan 2-chome, Minato-ku, Tokyo, 108-8215, Japan

<http://www.mhi-mth.co.jp/en/>

Because of our policy of continuous improvement, we reserve the right to make changes in all specifications without notice.

© Copyright MITSUBISHI HEAVY INDUSTRIES THERMAL SYSTEMS, LTD.