



DATA BOOK

VRF INVERTER MULTI-SYSTEM AIR-CONDITIONERS (OUTDOOR UNIT)

KXZ series (Heat pump type)

FDC224KXZME1, 280KXZME1, 335KXZME1A

• Note :

(1) Regarding the indoor unit series, refer to the No.'17•KX-T-266 and '18•KX-T-281.

PREFACE

Combination table for KX4 series and KX6 series

() Date of launching in the market

Category	Outdoor unit	Indoor unit									
		Connectable remote control	Same series	Same series	Same series	Mixed series	Mixed series	Mixed series	Same or Mixed series	Mixed series	Same series
		RC-E1	KXE4	KXE4(A)	KXE4A	KXE4A	KXE4A	KXE4A	KXE4R KXE4BR KXE5R	KXE4R KXE4BR KXE5R	KXE4R KXE4BR KXE5R
Heat pump (2-pipe) systems	FDCA-HKXE4 5HP (2004.4-)		YES [C]	YES [C]	YES [C]	NO	NO	NO	NO	NO	NO
	FDCA-HKXE4 8-48HP (2004.4-)		NO	YES [C]	YES [C]	NO	NO	NO	NO	NO	NO
	FDCA-HKXE4A 5HP (2006.2-)			YES [C]	YES [C]	YES [C] ^{*1}	NO	NO	YES [C] ^{*1}	NO	NO
	FDCA-HKXE4R 5,6HP (2006.5-)			YES [C]	YES [C]	YES [C] ^{*1}	NO	NO	YES [C] ^{*1}	NO	NO
	FDCA-HKXE4A 8-48HP (2006.2-)										
	FDCA-HKXE4R 8-48HP (2006.5-)										
	FDCA-HKXE4BR 8-48HP (2007.4-)		NO	YES [C]	YES [C]	YES [C]	YES [C]	YES [C]	YES [C]	YES [C]	YES [C]
	FDCA-HKXE4D 8-48HP (2008.7-)										
	FDC-KXE6 4,5,6HP (2008.3-)		NO	NO	NO	NO	NO	NO	NO	NO	YES [A] ^{*6}
	FDC-KXE6 8-12HP (2009.2-)		NO	NO	NO	NO	NO	NO	YES [B]	YES [B]	YES [A]
	FDC-KXE6 14-48HP (2009.1-)		NO	NO	NO	NO	NO	NO	YES [B]	YES [B]	YES [A]
	FDC-KXZE1 4,5,6HP (2018.2-)		NO	NO	NO	NO	NO	NO	NO	NO	YES [A] ^{*6}
FDC-KXZE1 10-60HP (2017.4-)		NO	NO	NO	NO	NO	NO	NO	NO	YES [A]	
FDC-KXZME1 8-12HP (2019.1-)											
FDC-KXZME1A 12HP (2020.3-)		NO	NO	NO	NO	NO	NO	NO	NO	YES [A]	
Heat recovery (3-pipe) systems [Note(3)]	FDCA-HKXRE4 8-48HP (2004.11-)		NO	NO	YES [C]	NO	NO	NO	NO	NO	NO
	FDCA-HKXRE4A 8-48HP (2006.2-)										
	FDCA-HKXRE4R 8-48HP (2006.6-)		NO	NO	YES [C]	YES [C]	YES [C]	YES [C]	YES [C]	YES [C]	YES [C]
	FDCA-HKXRE4BR 8-48HP (2007.4-)										
	FDCA-HKXRE4D 8-48HP (2008.7-)										
	FDC-KXRE6 8-48HP (2009.5-)		NO	NO	NO	NO	NO	NO	YES [B]	YES [B]	YES [A]
FDC-KXZRE1 8-60HP (2017.4-)		NO	NO	NO	NO	NO	NO	NO	NO	YES [A]	

*1 except FDKA71KXE5R

Notes (1) YES: Connectable (See following table in detail), NO: Not connectable

	Outdoor unit	Connected Indoor unit		Dip switch setting of outdoor unit KXE6	Superlink Protocol	Limitation
		Same series	Mixed series			
YES [A] ^{*2}	KXE6&KXZ	KXE6&KXZ		II (New)	New (for KX6)	New (for KX6)
YES [B]		KXE4 series	KXE6 & KXE4 series	I (Previous)	Previous (for KX4)	Previous (for KX4)
YES [C]		KXE4 series	KXE4 series	KXE4 series		Previous (for KX4)

^{*2} If Outdoor unit system (YES [A]) is connected to other outdoor unit systems (YES [B] and/or YES [C]) in one Superlink network, the DIP switch of outdoor unit KXE6 of (YES [A]) should be set from II (New) to I (Previous). In this case the Superlink protocol and limitation of outdoor unit system (YES [A]) are switched to Previous (for KX4).

(2) Combination with new central control, PC windows central control and BMS interface unit

	Connectable I/U	Central control, PC windows central control and BMS interface unit					
		SC-SL1N-E	SC-SL2NA-E	SC-SL4-AE/BE	SC-WGWN-A/B	SC-LGWN-A	SC-BGWN-A/B
YES [A]	Connectable I/U	16	64	128 (128x1)	128 (64x2) ^{*3}	96 (48x2)	128 (64x2) ^{*3}
	Superlink protocol	New	New	New	New	New	New
YES[B] & YES[C]	Connectable network	1	1	1	2	2	2
	Connectable I/U	16	48	144 (48x3)	96 ^{*4} (48x2)	96 ^{*4} (48x2)	96 ^{*4} (48x2)
	Superlink ^{*5} protocol	Previous	Previous	Previous	Previous	Previous	Previous
	Connectable network	1	1	3	2	2	2

^{*3} Maximum number of AC cell is limited up to 96.

In case the number of connected indoor units are more than 96, some AC cells should hold 2 or more indoor units.

^{*4} In case of other central control like SC-SLx-E is connected in the same network, the connectable indoor unit is limited up to 64 (32x2).

^{*5} In case of previous Superlink protocol, the Superlink mode of new central control should be set "Previous".

^{*6} In case of YES[A], previous central control is available to use. But the limitation of connectable indoor unit and so on is complied with the rule of previous Superlink.

(3) The compatibility of PFD (refrigerant flow branching control) is mentioned in following table.

Connectable PFD control	Outdoor unit	Indoor unit	
		KXE4 & KXE5 series	KXE6 & KXZE1 series
KXRE4 series	KXRE4 series	PFD-E	PFD-E
		PFD-ER	PFD-ER
		PFD-ER	PFD-ER
KXRE6 series	KXRE6 series	PFD-E	PFD-E
		PFD-ER	PFD-ER
KXZRE1 series	KXZRE1 series	PFD-E	PFD-E
		PFD-ER	PFD-ER

Note:
All indoor unit downstream PFD box must be same series, KXZR, KX6 series or KX4/5 series

(4) Compatibility of the PFD control extension cables is as per the following table.

	PFD-control series	
	PFD *** 3-E	PFD *** 4-E
PFD-15WR-E	Yes	No
PFD4-15WR-E	No	Yes

CONTENTS

1. GENERAL INFORMATION	2
1.1 Increased indoor unit connection capacity.....	2
1.2 How to read the model name	2
1.3 Table of models	3
1.4 Branch pipe set and Header pipe set	3
2. OUTDOOR UNIT	4
2.1 Specifications	4
2.2 Exterior dimensions	5
2.3 Electrical wiring	8
2.4 Noise level	9
3. RANGE OF USAGE & LIMITATIONS	10
4. SELECTION CHART	12
5. PIPING SYSTEM	19
6. APPLICATION DATA	20
6.1 Installation of outdoor unit	20
6.2 Check operation procedure	36
6.3 Method for connecting the accessory pipe	37
6.4 Instructions for installing the branch pipe set	39
7. TECHNICAL INFORMATION	43
7.1 Outdoor units	43
7.2 Indoor units	49

1. GENERAL INFORMATION

1.1 Increased indoor unit connection capacity

- Capacity from 50% to 150% is possible

Model	Item	Number of connectable	Connectable capacity
FDC224KXZME1		1 to 22 units	112 - 336
FDC280KXZME1		1 to 24 units	140 - 420
FDC335KXZME1A		1 to 24 units	167 - 502

Note (1) If one or more indoor units of FDK, FDFL, FDFU and/or FDFW series are connected to the system, the total connecting capacity of indoor units should not exceed 130%.

Note (2) If superlink I (previous superlink) is selected, the connectable indoor capacity should not exceed 130% of outdoor capacity.

1.2 How to read the model name

(1) Outdoor unit

Example: **FDC 224 KXZM E 1**

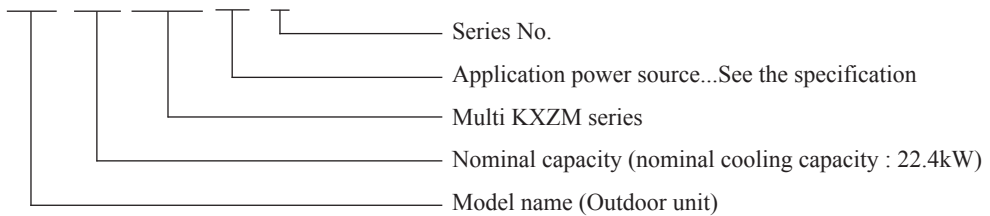

(2) Indoor unit

Example: **FDT 28 KXZ E 1**

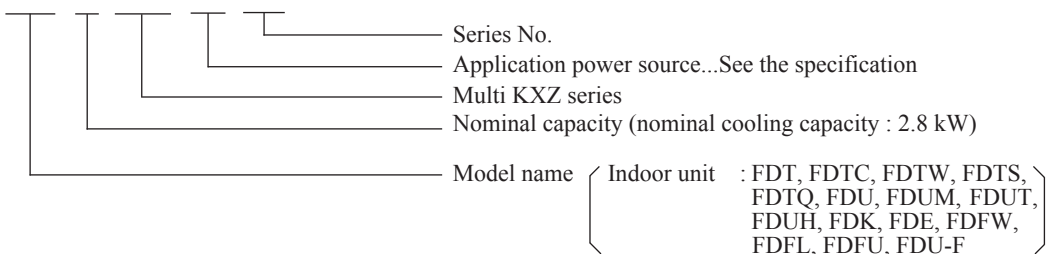

Note

This unit complies with EN61000-3-3.
 For outdoor unit, EN61000-3-2 is not applicable as consent by the utility company or notification to the utility company is given before usage. (Only 224, 280)
 For outdoor unit, EN61000-3-12 is not applicable as consent by the utility company or notification to the utility company is given before usage. (Only 335)

1.3 Table of models

Model	Capacity													
	(1) 15	22	28	36	45	56	71	90	112	140	160	224	280	
Ceiling cassette-4 way type (FDT)			○	○	○	○	○	○	○	○	○			
Ceiling cassette-4 way compact type (FDC)	○	○	○	○	○	○								
Ceiling cassette-2 way type (FDTW)			○		○	○	○	○	○	○				
Ceiling cassette-1 way type (FDTs)					○		○							
Ceiling cassette-1 way compact type (FDTQ)		○	○	○										
Duct connected-High static pressure type (FDU)					○	○	○	○	○	○	○	○	○	
Duct connected-Low/Middle static pressure type (FDUM)		○	○	○	○	○	○	○	○	○	○			
Duct connected-Low static pressure(thin) type (FDUT)	○	○	○	○	○	○	○							
Duct Connected-Compact and flexible type (FDUH)		○	○	○										
Wall mounted type (FDK)	○	○	○	○	○	○	○	○						
Ceiling suspended type (FDE)				○	○	○	○		○	○				
Floor standing-2 way type (FDFW)			○		○	○								
Floor standing-With casing type (FDFL)							○							
Floor standing-Without casing type (FDFU)			○		○	○	○							
OA processing unit type (FDU-F)								○		○		○	○	
Outdoor units to be combined (FDC)	FDC224KXZME1, 280KXZME1, 335KXZME1A													

Note(1) With 1.5kW-indoor units connection in the system, installation limitation must be as follows.
 Total indoor unit connection capacity ratio : 100% or more.
 Total piping length between outdoor unit and indoor units, including both main and branch piping : 150m or more
 Outdoor temperature condition in the cooling operation : 10°C or more

1.4 Branch pipe set and Header pipe set

(a) Branch pipe set (Option)

Total capacity downstream	Branching pipe set
Less than 180	DIS-22-1G
180 or more but less than 371	DIS-180-1G
371 or more but less than 540	DIS-371-1G

(b) Header pipe set (Option)

Total capacity downstream	Header set model type	Number of branches
Less than 180	HEAD4-22-1G	4 branches at the most
180 or more but less than 371	HEAD6-180-1G	6 branches at the most
371 or more but less than 540	HEAD8-371-2	8 branches at the most

2. OUTDOOR UNIT

2.1 Specifications

Models FDC224KXZME1, 280KXZME1, 335KXZME1A

(50/60 Hz)

Models			FDC224KXZME1	FDC280KXZME1	FDC335KXZME1A
Nominal cooling capacity*1		kW	22.4	28.0	33.5
Nominal heating capacity*2			22.4	28.0	33.5
Maximum heating capacity			25.0	31.5	37.5
Power source			3 Phase 380/415V 50Hz / 380V 60Hz		
Power consumption	Cooling	kW	5.59	7.90	10.68
	Heating		4.97	6.53	8.44
Running current	Cooling	A	9.4/8.6	12.8/11.8	17.8/16.3
	Heating		7.8/7.2	10.5/9.6	14.4/13.2
Power factor	Cooling	%	91/91	94/94	91/91
	Heating		97/97	95/95	91/91
EER			4.00	3.54	3.13
COP			4.50	4.28	3.96
Sound pressure level (Cooling/Heating)		dB (A)	58/59	60/60	60/62
Sound power level (Cooling/Heating)		dB (A)	73/75	75/76	75/77
Starting current		A	5		
Maximum current			20.0	20.0	23.0
Exterior dimensions Height × Width × Depth		mm	1675×1080×480		
Exterior appearance (Munsell color)			Stucco white (4.2Y7.5/1.1) near equivalent		
Net weight		kg	221		224
Compressor type & Q'ty			GTC5150NH40K × 1		
Compressor motor		kW	4.69	6.78	9.59
Starting method			Direct line starting		
Capacity control		%	24-100	18-100	17-100
Crankcase heater		W	33		
Heat exchanger			Straight fin & inner grooved tubing		
Refrigerant control			Electronic expansion valve		
Refrigerant type			R410A		
Refrigerant amount		kg	11.5		
Refrigerant oil		ℓ	1.7 (M-MA32R)		
Defrost control			Microcomputer controlled De-Icer		
Fan type & Q'ty			Propeller fan × 2		
Fan motor		W	144 × 2		
Starting method			Direct start		
Air flow (Standard)		m ³ /min	200		
Available external static pressure		Pa	Max.35		
Shock & vibration absorber			Rubber mount (for compressor)		
Safety equipment			Compressor overheat protection, Overcurrent protection, Power transistor overheating protection, Abnormal high pressure protection		
Refrigerant piping size	Liquid line	mm (in)	φ 9.52 (3/8")		φ 12.7 (1/2")
	Suction gas line	mm (in)	φ 19.05 (3/4")	φ 22.22 (7/8")	φ 25.4 (1") (φ 22.22 (7/8"))
Connecting method			Gas line: Brazing / Liquid line: Flare		
MAX. Pressure		MPa	High 4.15, Low 2.21		
Drain			Hole for drain (φ 20 × 4pcs)		
Insulation for piping			Necessary (both Liquid & Gas line)		
IP number			IP24		
Accessories			-	-	-

Notes (1) The data are measured at the following conditions.

Item	Indoor air temperature		Outdoor air temperature		Standards
	DB	WB	DB	WB	
Cooling	27°C	19°C	35°C	24°C	ISO5151-T1,H1
Heating	20°C	—	7°C	6°C	

- (2) This air-conditioner is manufactured and tested in conformity with the ISO.
- (3) Sound level indicates the value in an anechoic chamber.
During operation these values are somewhat higher due to ambient conditions.
- (4) Refrigerant piping size applicable to European installations are shown in parentheses.
- (5) This air-conditioner is adapted RoHS directive.

PCB004Z395

2.2 Exterior dimensions

Model FDC224KXZME1

Notes

- (1) It must not be surrounded by walls on the four sides.
- (2) The unit must be fixed with anchor bolts. An anchor bolt must not protrude more than 15mm.
- (3) Where the unit is subject to strong winds, lay it in such a direction that the blower outlet faces perpendicularly to the dominant wind direction.
- (4) Leave 1m or more space above the unit.
- (5) A wall in front of the blower outlet must not exceed the units height.
- (6) The model name label is attached on the lower right corner of the front.
- (7) Connect the Service valve with local pipe by using the pipe of the attachment.
(Gas side only)
- (8) Mark \times shows the connecting position of the local pipe. (Gas side only)

Symbol	Content	Content
A	Service valve connection of the attached connecting pipe (gas side)	ϕ 19.05 (3 / 4") (Flare)
B	Service valve connection (liquid side)	ϕ 9.52 (3 / 8") (Flare)
C	Pipe / cable draw-out hole	4 places
D	Drain discharge hole	ϕ 20 \times 4 places
E	Anchor bolt hole	M10 \times 4 places
F	Cable draw-out hole	ϕ 30 \times 2 places (front) ϕ 45 (side) ϕ 30 \times 2 places (back)
G	Connecting position of the local pipe. (gas side)	ϕ 19.05 (3 / 4") (Brazing)

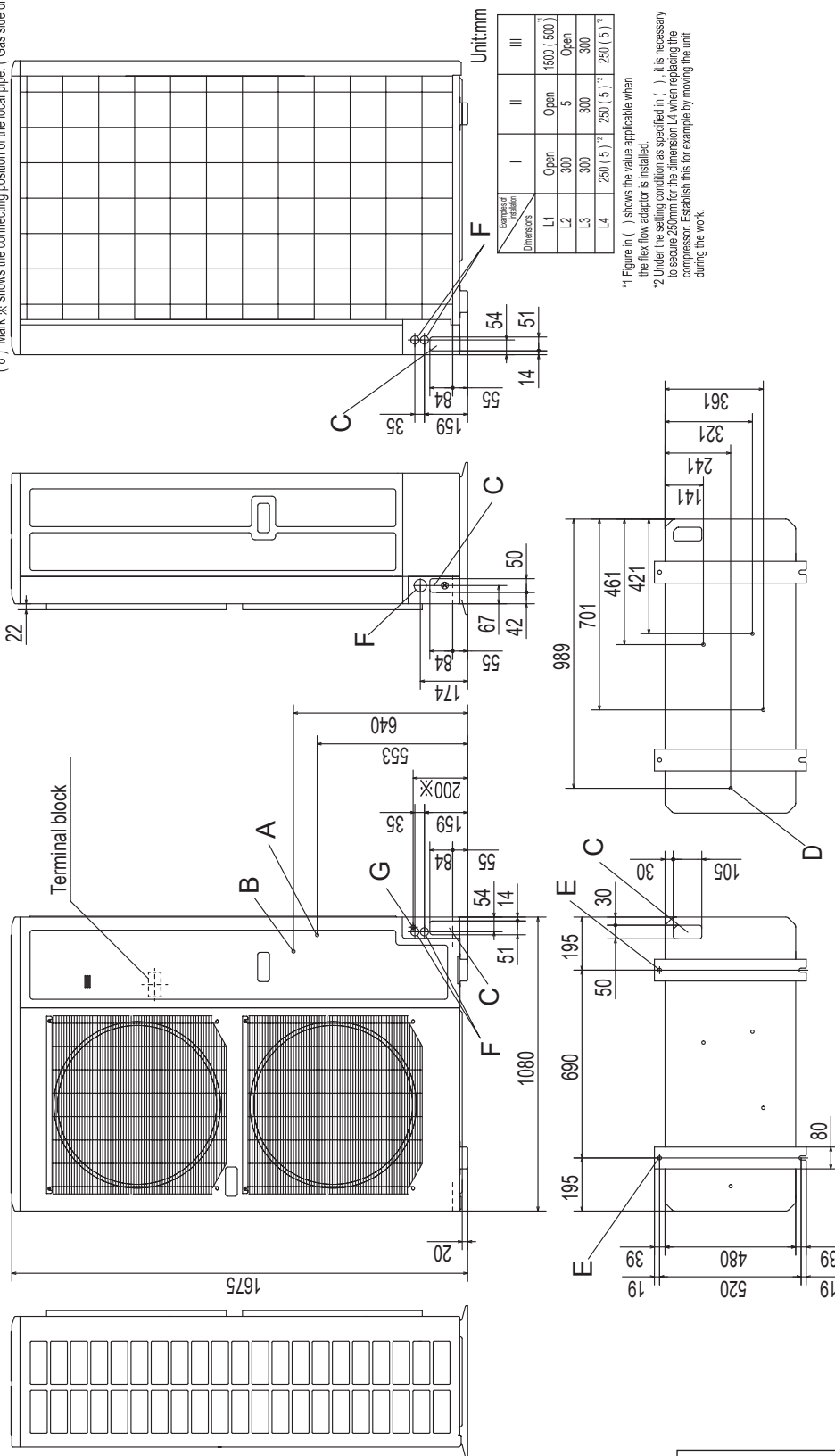
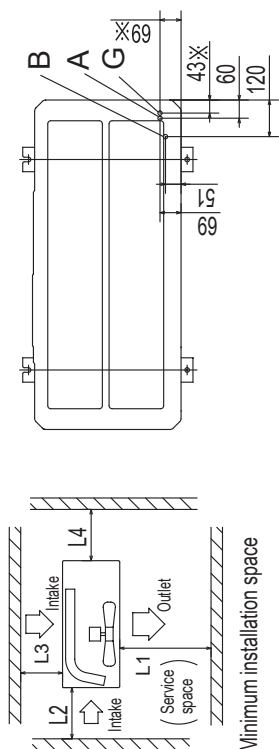

PCB004Z331

Model FDC280KXZME1

Notes

- (1) It must not be surrounded by walls on the four sides.
- (2) The unit must be fixed with anchor bolts. An anchor bolt must not protrude more than 15mm.
- (3) Where the unit is subject to strong winds, lay it in such a direction that the blower outlet faces perpendicularly to the dominant wind direction.
- (4) Leave 1m or more space above the unit.
- (5) A wall in front of the blower outlet must not exceed the units height.
- (6) The model name label is attached on the lower right corner of the front.
- (7) Connect the Service valve with local pipe by using the pipe of the attachment. (Gas side only)
- (8) Mark X shows the connecting position of the local pipe. (Gas side only)

Symbol	Content
A	Service valve connection of the attached connecting pipe (gas side)
B	Service valve connection (liquid side)
C	Pipe / cable draw-out hole (4 places)
D	Drain discharge hole
E	Anchor bolt hole
F	Cable draw-out hole
G	Connecting position of the local pipe. (gas side)

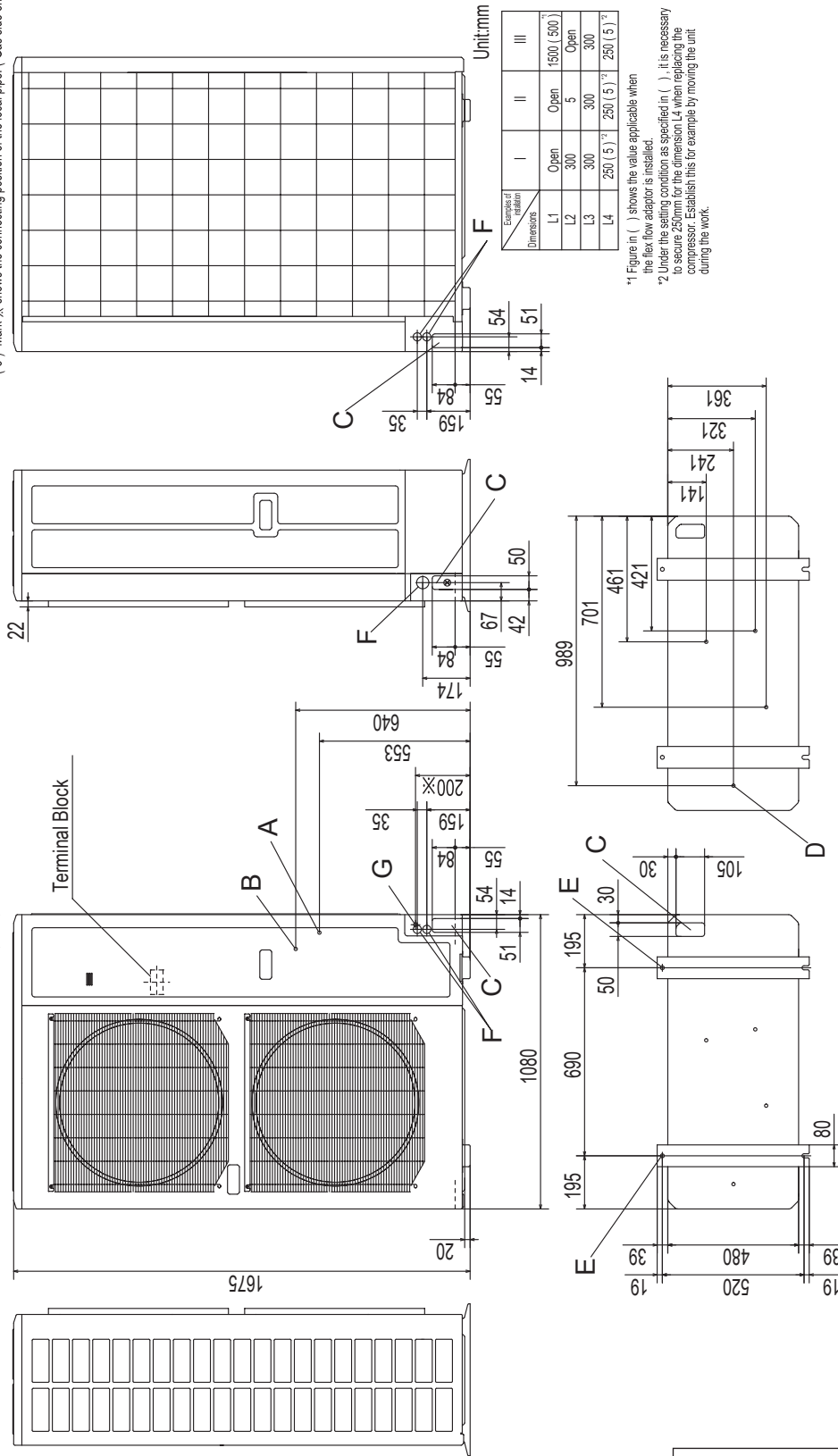
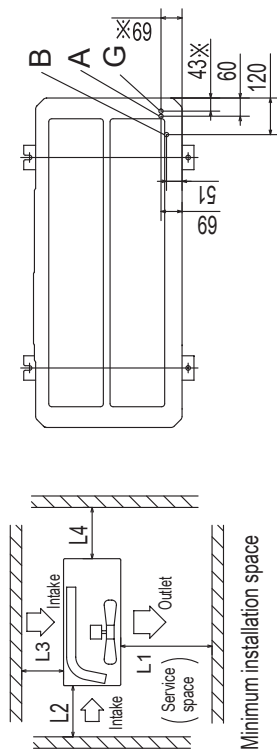

PCB004Z332

Model FDC335KXZME1A

- Notes
- (1) It must not be surrounded by walls on the four sides.
 - (2) The unit must be fixed with anchor bolts. An anchor bolt must not protrude more than 15mm.
 - (3) Where the unit is subject to strong winds, lay it in such a direction that the blower outlet faces perpendicularly to the dominant wind direction.
 - (4) Leave 1m or more space above the unit.
 - (5) A wall in front of the blower outlet must not exceed the units height.
 - (6) The model name label is attached on the lower right corner of the front.
 - (7) Connect the Service valve with local pipe by using the pipe of the attachment.
(Gas side only)
 - (8) Mark \times shows the connecting position of the local pipe. (Gas side only)

Symbol	Content	Content
A	Service valve connection of the attached connecting pipe (gas side)	$\phi 19.05$ (3 / 4 ") (Flare)
B	Service valve connection (liquid side)	$\phi 12.7$ (1 / 2 ") (Flare)
C	Pipe / cable draw-out hole	4 places
D	Drain discharge hole	$\phi 20 \times 4$ places
E	Anchor bolt hole	M10 \times 4 places
F	Cable draw-out hole	$\phi 30 \times 2$ places (front) $\phi 45$ (side) $\phi 30 \times 2$ places (back)
G	Connecting position of the local pipe. (gas side)	$\phi 25.4$ (1 ") (Brazing)

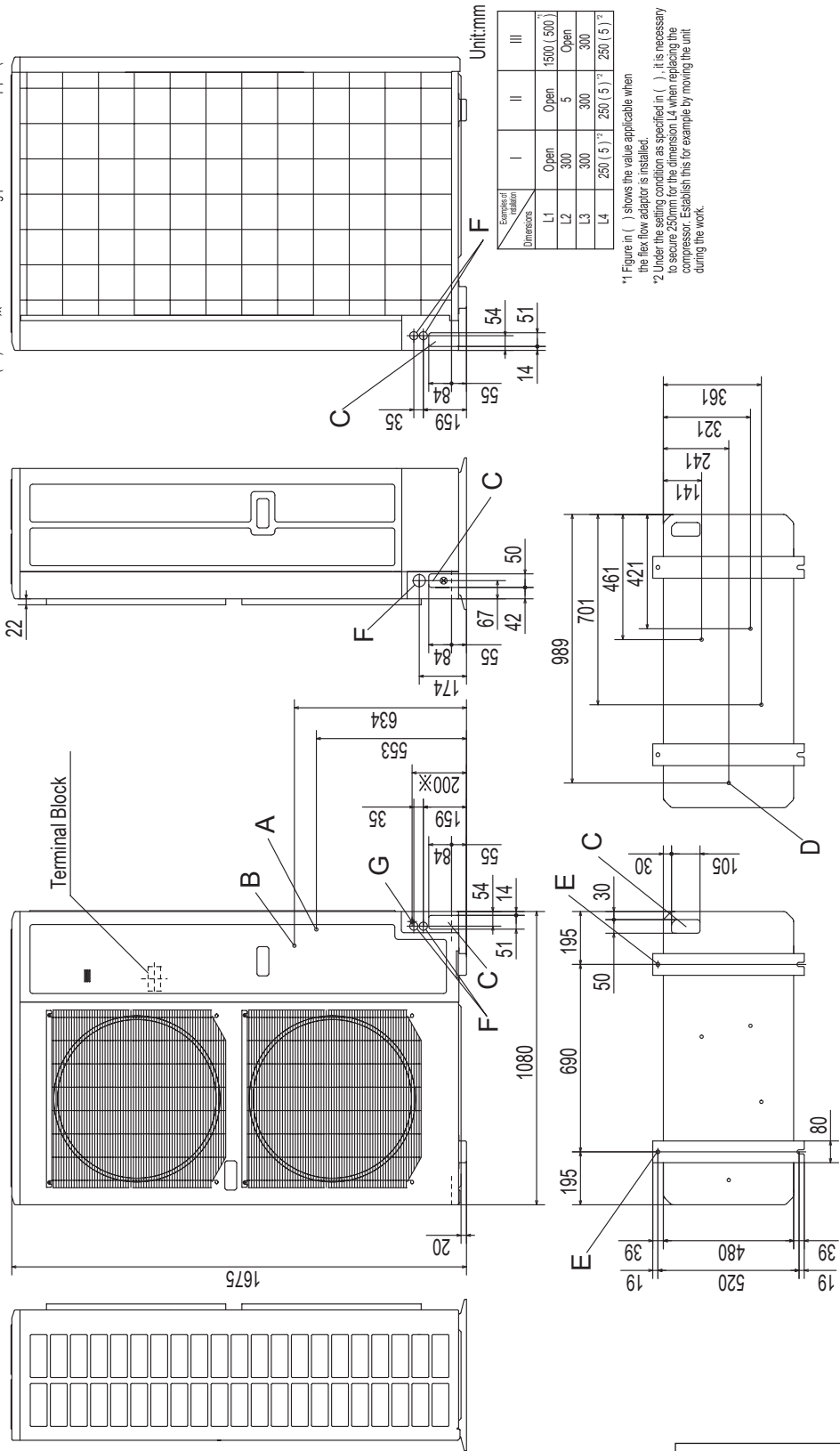
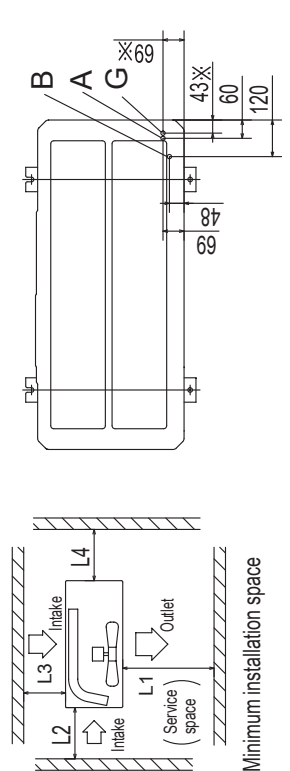

*1 Figure in () shows the value applicable when the flex-flow adaptor is installed.
 *2 Under the setting condition as specified in (), it is necessary to secure 250mm for the dimension L4 when replacing the compressor. Establish this for example by moving the unit during the work.

PCB004Z396

2.3 Electrical wiring

Models FDC224KXZME1, 280KXZME1, 335KXZME1A

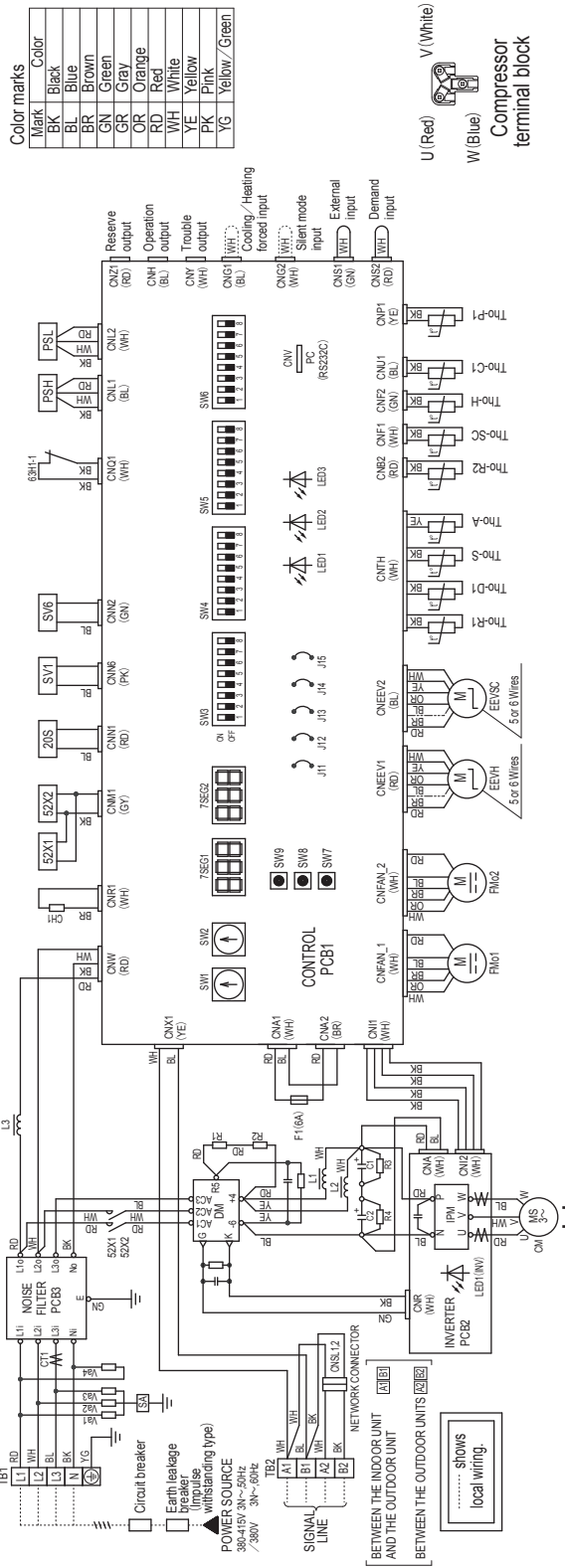

Meaning of marks

Mark	Name	Mark	Name	Mark	Name
CH1	Crankcase heater	SW1	Address setting SW outdoor unit No. (tens place)	TB1.2	Terminal block
CM	Compressor motor	SW2	Address setting SW outdoor unit No. (units place)	Tho-A	External air temperature sensor
CNA-Z1	Connector	SW3-1	Inspection LED reset	Tho-C1	Under-dome temperature sensor
C11	Current sensor	SW3-2-6	Spare	Tho-D1	Discharge pipe temperature sensor
C1.2	Electrolytic capacitor	SW3-7	ON Forced heating / cooling mode	Tho-H	Super-cooling coil temperature sensor 2
DM	Diode module	SW3-8	ON Test mode	Tho-P1	Power transistor temperature sensor
EEVH	Heating expansion valve	SW4-1-4	OFF Normal operation	Tho-R1	Heat exchanger temperature sensor 1
EEVSC	Super-cooling coil expansion valve	SW4-5-6	OFF Model setting	Tho-R2	Heat exchanger temperature sensor 2
FM01.2	Blower motor	SW4-7,8	ON Demand switching	Tho-S	Suction pipe temperature sensor
F1	Fuse	SW5-1	Spare	7SEG1	7-segment LED (Data display)
IPM	Intelligent power module	SW5-2	ON Test run	7SEG2	7-segment LED (Function display)
J11.12	Power source, voltage switching	SW5-3	OFF Normal operation	Z0S	4-way switching solenoid
J13	External input switching level / pulse	SW5-4	Spare	52X1.2	Solenoid for CM
J14	Spare	SW5-5	ON Super Link communication	63H1-1	High pressure switch (Protection)
J15	Defrosting start temperature selection, normal / cold region	SW5-6	OFF Super Link II communication		
LED1	Inspection (Red)	SW5-7	Model setting		
LED1 (INV)	Normal (Yellow) Flashing	SW5-8	Unit communication error detection		
LED2	Normal (Green)	SW5-9	Data delete / write		
LED3	Service (Green)		7-segment indication (units place)		
L1-L3	DC reactor		7-segment indication (tens place)		
L1-L3	High pressure sensor				
PSL	Low pressure sensor				
PCB1-3	Printed-circuit board				
R1-4	Rush current suppression resistor				
SV1	Solenoid valve (fluid return)				
SV6	Solenoid valve (oil return)				

PCB004Z397 A

2.4 Noise level

Sound pressure level

Measured based on JIS B 8616

Mike position as highest noise level in position as below

Distance from front side 1m

Height 1m

Model FDC224KXZME1

Noise level 58 dB (A)

Cooling

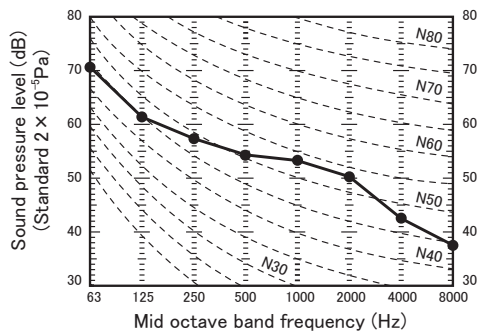

Noise level 59 dB (A)

Heating

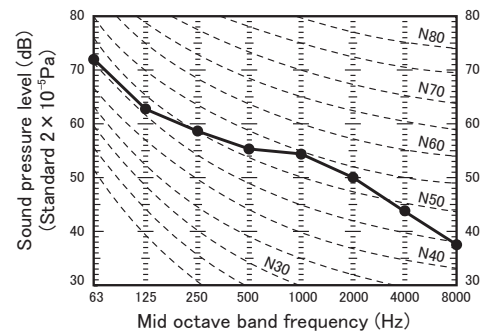

Model FDC280KXZME1

Noise level 60 dB (A)

Cooling

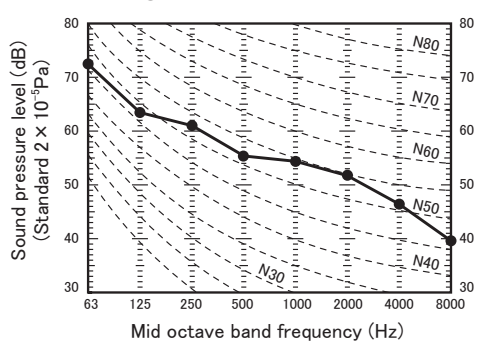

Noise level 60 dB (A)

Heating

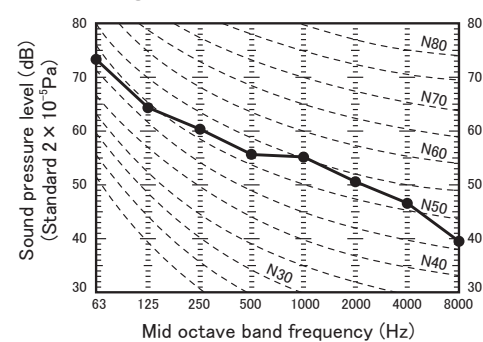

Model FDC335KXZME1A

Noise level 60 dB (A)

Cooling

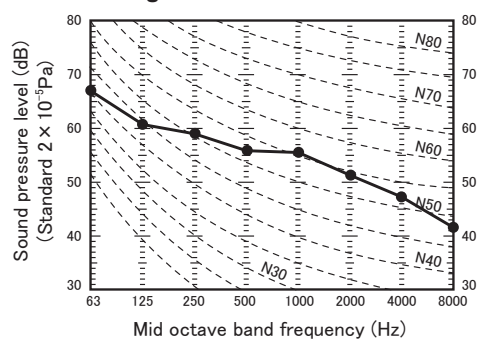

Noise level 62 dB (A)

Heating

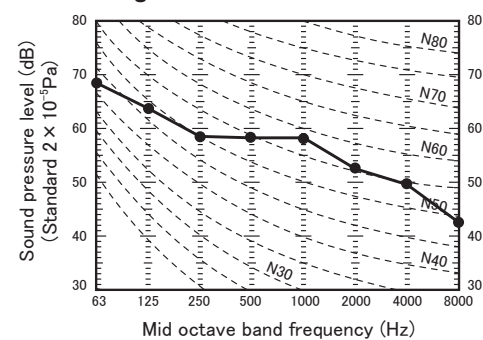

3. RANGE OF USAGE & LIMITATIONS

System		FDC224KXZME1	FDC280KXZME1	FDC335KXZME1A
Indoor intake air temperature (Upper, lower limits)		Please see the next page.		
Outdoor air temperature (Upper, lower limits)				
Indoor units that can be used in combination	Number of connected units	1 to 22 unit	1 to 24 unit	1 to 24 unit
	Connectable capacity ⁽¹⁾	112 - 336	140 - 420	167 - 502
Total piping length		510m or less		
Main pipe length		130m or less		
Single direction piping length		Actual length : 160m or less, Equivalent length : 185m or less		
Allowable pipe length from the first branching		90m or less (However, difference between the longest and shortest piping : 40m or less)		
Elevation difference between the first branching point and the indoor unit		18m or less		
Difference in height between indoor and outdoor units	Outdoor unit is higher	50m or less		
	Outdoor unit is lower	40m or less		
Difference in the elevation of indoor units in a system		18m or less		
Indoor unit atmosphere (behind ceiling) temperature and humidity (Only models FDT, FDTC, FDTW, FDTS, FDTQ, FDU, FDUM, FDUT, FDUH)		Dew point temperature 28 °C or less, relative humidity 80% or less (FDE, FDK, FDFL, FDFU : Dew point temperature 23 °C or less, relative humidity 80% or less)		
Compressor stop/start frequency	1 cycle time	6 minutes or more (3 minutes or more from start to stop or 3 minutes or more from stop to start)		
	Stop time	3 minutes or more		
Power source voltage	Voltage fluctuation	Within ±10% of rated voltage		
	Voltage drop during start	Within ±15% of rated voltage		
	Phase unbalance	Within ±3% of rated voltage		

Note(1) If superlink I (previous superlink) is selected, all the range of usage and limitations, not only the limitations of connectable indoor capacity and connectable number of indoor unit but also of the piping length, operating temperature range and etc., become same as those of KX4 (See technical manual '07 • KX • KXR-T-114). In addition to above limitations, all of new functions for KX6 such as automatic address setting function for multiple refrigerant systems and etc. will be cancelled.

Allowable length of refrigerant piping, height difference between indoor and outdoor unit

(1) Branch pipe method (using branch piping)

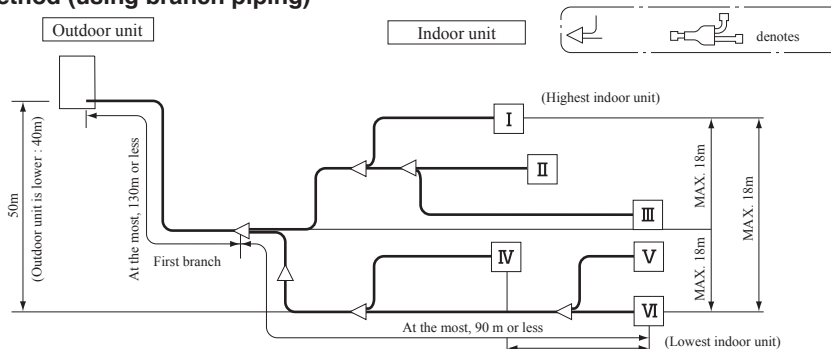

(2) Header System (Header used)

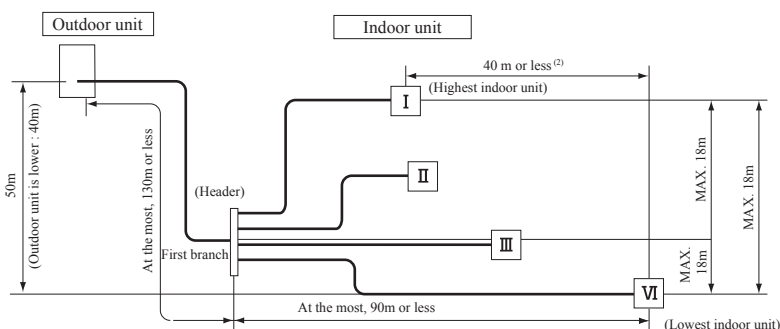

Note (1) A branch piping system cannot be connected after a header system.

(2) 90m or less (However, difference between the longest and shortest piping : 40m or less)

(3) Mixed System (Branch piping and Header used)

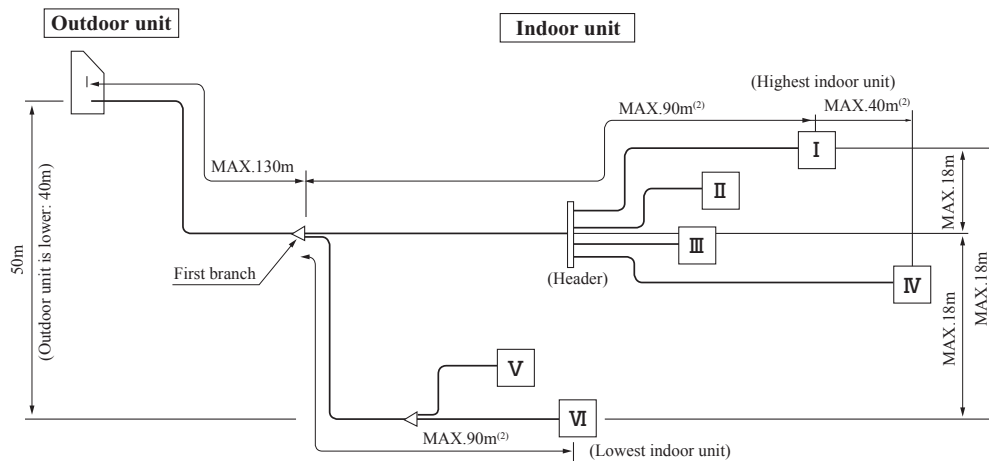

- Notes (1) A branch piping system cannot be connected after a header system.
 (2) 90m or less (However, difference between the longest and shortest piping : 40m or less)

Operating temperature range

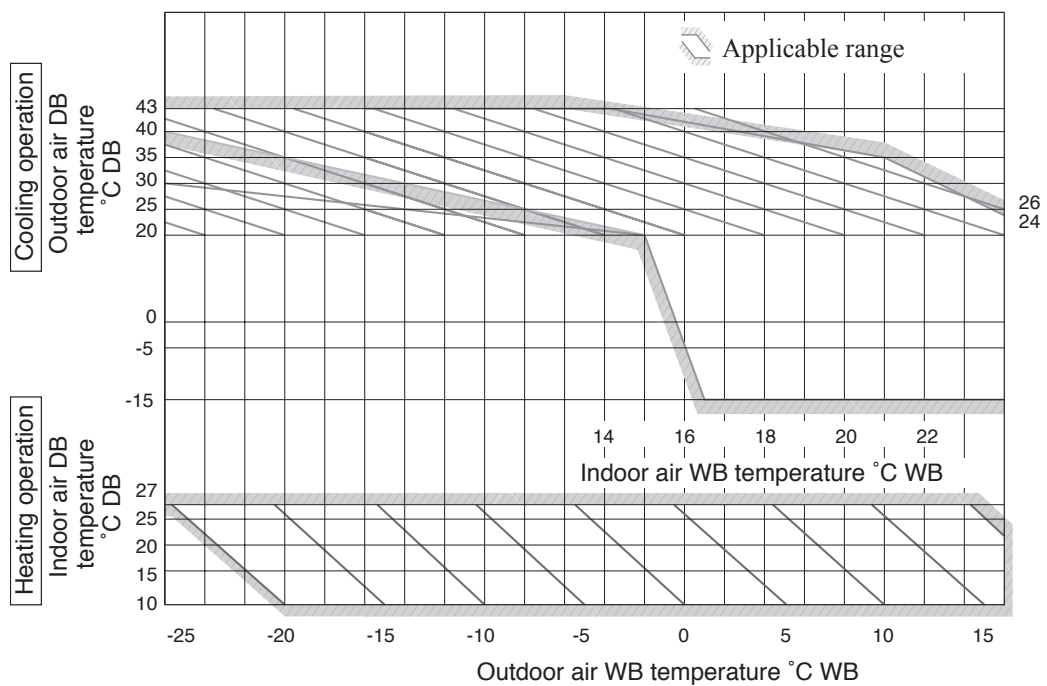

“CAUTION” Cooling operation under low outdoor air temperature conditions

KXZME1 models can be operated in cooling mode at low outdoor air temperature condition within above temperature range. However in case of severely low temperature conditions if the following precaution is not observed, it may not be operated in spite of operable temperature range mentioned above and cooling capacity may not be established under certain conditions.
 [Precaution]

In case of severely low temperature condition

- 1) Install the outdoor unit at the place where strong wind cannot blow directly into the outdoor unit.
- 2) If there is no installation place where can prevent strong wind from directly blowing into the outdoor unit, prepare a windbreak fence or something like that locally in order to divert the strong wind from the outdoor unit.

[Reason]

Under the low outdoor air temperature conditions of -5°C or lower, if strong wind directly blow into the outdoor unit, the outdoor heat exchanger temperature will drop, even though the outdoor fan is stopped by outdoor fan control. This makes high and low pressures to drop as well. This low pressure drop makes the indoor heat exchanger temperature to drop and will activate anti-frost control at indoor heat exchanger at frequent intervals, that cooling operation may not be established for any given time.

4. SELECTION CHART

(1) Equipment selection flow

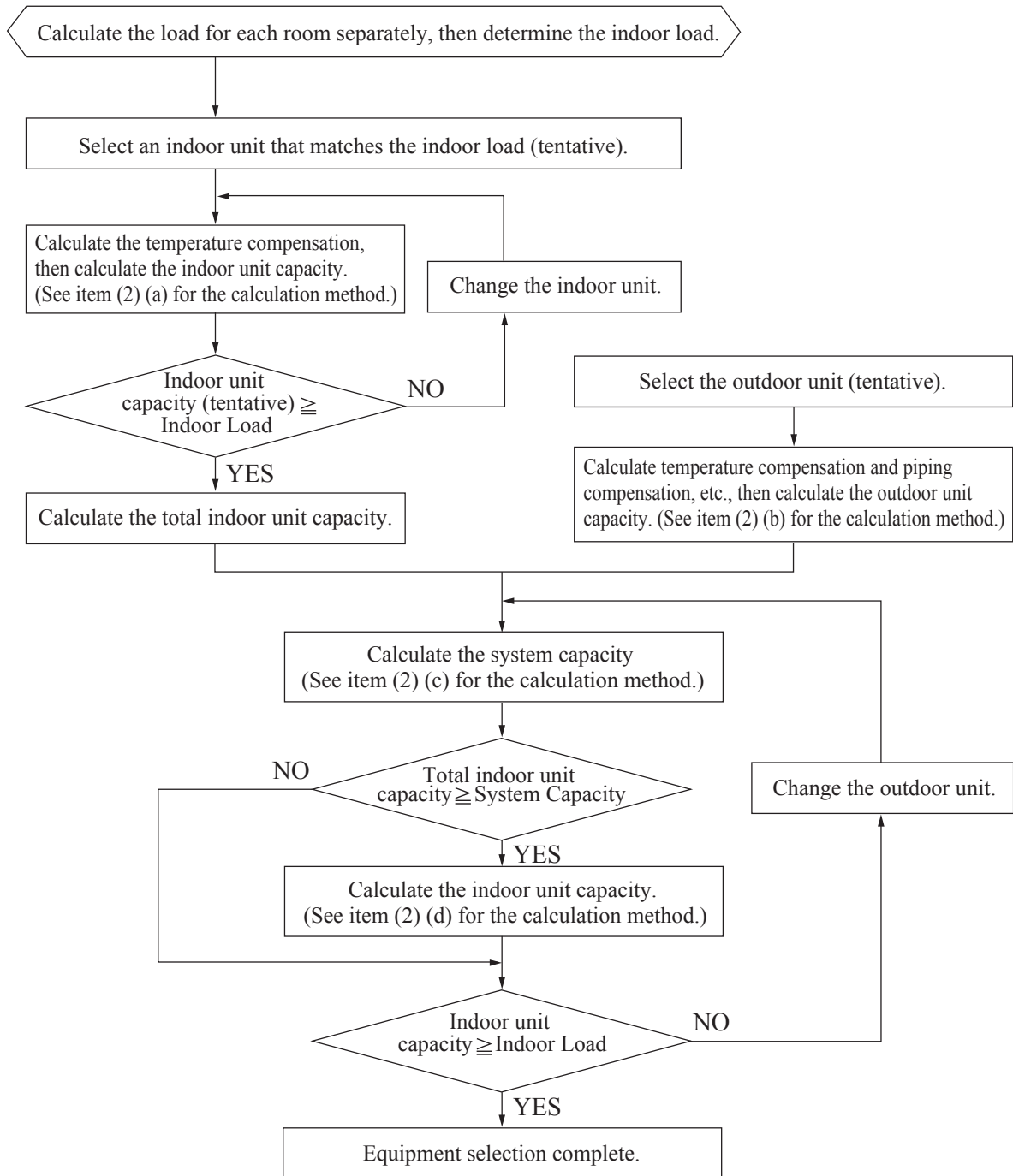

(2) Capacity calculation method**(a) Calculating the indoor unit capacity compensation**

Indoor unit capacity (cooling, heating) = Indoor unit total rated capacity
 × Capacity compensation coefficient according to temperature conditions
 See item (3) (a) concerning the capacity compensation coefficient according to temperature conditions.

(b) Calculating the outdoor unit capacity compensation

Outdoor unit capacity (Cooling, Heating) = Outdoor unit rated capacity (rated capacity when 100% connected)
 × Capacity compensation coefficient according to temperature conditions
 × Capacity compensation coefficient according to piping length
 × Capacity compensation coefficient according to height difference
 × Correction of heating capacity in relation to the frost on the outdoor unit heat exchanger
 × Capacity compensation coefficient according to indoor unit connection capacity

- ① See item (3) (a) concerning the capacity compensation coefficient according to temperature conditions.
- ② See item (3) (b) concerning the capacity compensation coefficient according to piping length.
- ③ See item (3) (c) concerning the capacity compensation coefficient according to height difference. This compensation should be carried out only in cases where the outdoor unit is lower during cooling and higher during heating.
- ④ See item (3) (d) correction of heating capacity in relation to the frost on the outdoor unit heat exchanger. This compensation should be carried out only when calculating the heating capacity.
- ⑤ See item (3) (e) concerning the capacity compensation coefficient according to indoor unit connected capacity. This compensation should be carried out only in cases where the indoor unit total capacity is 100% or higher.

(c) Calculating system capacity

Compare the capacities determined in items (a) and (b) above and let the smaller value be the system capacity (cooling, heating).

- ① In cases where indoor unit total capacity (cooling, heating) > outdoor unit capacity (cooling, heating)
 System capacity (cooling, heating) = Outdoor unit capacity (cooling, heating)
- ② In cases where indoor unit total capacity (cooling, heating) < outdoor unit capacity (cooling, heating)
 System capacity (cooling, heating) = Indoor unit capacity (cooling, heating)

(d) Calculating indoor unit capacity [item (c) ① only]

Indoor unit capacity (cooling, heating) = System capacity (cooling, heating)
 × [(Indoor unit capacity) / (Indoor unit total capacity)]

Capacity calculation examples**Example 1****Cooling (when the indoor unit connected total capacity is less than 100%)**

- Outdoor unit FDC224KXZME1 1 unit
- Indoor unit FDT56KXZE1 3 units
- Piping length 60 m (Equivalent length)
- Indoor, outdoor unit height difference 15 m (Outdoor unit is lower)
- Temperature conditions Outdoor temperature: 33°C DB
- Temperature conditions Indoor temperature: 19°C WB

<Indoor unit total cooling capacity>: Item (2) (a) calculation.

- Indoor unit rated cooling capacity: 5.6 kW
- Capacity compensation coefficient according to temperature conditions:
 1.02 (Calculated according to Indoor 19°C WB / Outdoor 33°C DB); (See page 15.)
 Indoor unit cooling capacity: 5.6 kW × 1.02 = 5.7 kW
- Indoor unit total cooling capacity calculation;
 indoor unit total cooling capacity: 5.7 kW × 3 units = 17.1 kW

<Outdoor unit maximum cooling capacity> : Item (2) (b) calculation

- Outdoor unit rated cooling capacity: 22.4 kW
- Capacity compensation coefficient according to temperature conditions:
 1.02 (Calculated according to Indoor 19°C WB / Outdoor 33°C DB); (See page 15.)
 Outdoor unit cooling capacity: 22.4 kW × 1.02 = 22.8 kW
- Capacity compensation coefficient according to piping length: 0.92 (calculated according to 60 m length); (See page 17.)
 22.8 kW × 0.92 = 21.0 kW

- Capacity compensation coefficient according to height difference: 0.97 (calculated according to 15 m difference); (See page 18)
 $21.0 \text{ kW} \times 0.97 \approx \underline{20.4 \text{ kW}}$
- Capacity compensation coefficient according to indoor unit connected total capacity: $1.0 \leftarrow (56 \times 3) / 224 < 100\%$
 No compensation

<System cooling capacity>: Item (2) (c) calculation

Compare the indoor unit total cooling capacity and the outdoor unit maximum cooling capacity. The smaller value is the actual system cooling capacity.

- Indoor unit total cooling capacity: 17.1 kW \Rightarrow System cooling capacity: 17.1 kW
- Outdoor unit maximum cooling capacity: 20.4 kW

<Indoor unit capacity compensation> No compensation (5.7 kW)

Example 2

Cooling (when the indoor unit connected total capacity is 100% or higher)

- Outdoor unit FDC224KZME1 1 unit
- Indoor unit FDT56KXZE1 5 units
- Piping length 60 m (Equivalent length)
- Indoor, outdoor unit height difference 15 m (Outdoor unit is higher)
- Temperature conditions Outdoor temperature: 35°C DB
- Temperature conditions Indoor temperature: 18°C WB

<Indoor unit total cooling capacity>: Item (2) (a) calculation

- Indoor unit rated cooling capacity: 5.6 kW
- Capacity compensation coefficient according to temperature conditions:
 0.95 (Calculated according to Indoor 18°C WB / Outdoor 35°C DB); (See page 15.)
 Indoor unit cooling capacity: $5.6 \text{ kW} \times 0.95 \approx 5.3 \text{ kW}$
- Indoor unit total cooling capacity calculation;
 indoor unit total cooling capacity: $5.3 \text{ kW} \times 5 \text{ units} \approx \underline{26.5 \text{ kW}}$

<Outdoor unit maximum cooling capacity> : Item (2) (b) calculation

- Outdoor unit rated cooling capacity: 22.4 kW
- Capacity compensation coefficient according to temperature conditions:
 0.95 (Calculated according to Indoor 18°C WB / Outdoor 35°C DB); (See page 15.)
 Outdoor unit cooling capacity: $22.4 \text{ kW} \times 0.95 \approx 21.3 \text{ kW}$
- Capacity compensation coefficient according to piping length: 0.92 (calculated according to 60 m length); (See page 17.)
 $21.3 \text{ kW} \times 0.92 \approx 19.6 \text{ kW}$
- Capacity compensation coefficient according to height difference: 1.0 (the outdoor unit is higher during cooling)
 No compensation
- Capacity compensation coefficient according to indoor unit connected total capacity: $1.08 \leftarrow (56 \times 5) / 224 \approx 125\%$ (See page 18.)
 $19.6 \text{ kW} \times 1.08 \approx \underline{21.2 \text{ kW}}$

<System cooling capacity>: Item (2) (c) calculation

Compare the indoor unit total cooling capacity and the outdoor unit maximum cooling capacity. The smaller value is the actual system cooling capacity.

- Indoor unit total cooling capacity : 26.5 kW \Rightarrow System cooling capacity: 21.2 kW
- Outdoor unit maximum cooling capacity : 21.2 kW

<Indoor unit cooling capacity Compensation>: Item (2) (d) calculation

$$\frac{21.2 \text{ kW} \times 5.3 \text{ kW}}{26.5 \text{ kW}} \approx \underline{4.2 \text{ kW}}$$

Example 3

Heating (when the indoor unit connected total capacity is 100% or higher)

- Outdoor unit FDC224KXZME1..... 1 unit
- Indoor unit FDT56KXZE1 5 units
- Piping length 60 m (Equivalent length)
- Indoor, outdoor unit height difference 20 m (Outdoor unit is higher)
- Temperature conditions Outdoor temperature: 6°C WB
- Temperature conditions Indoor temperature: 19°C DB

<Indoor unit total heating capacity>: Item (2) (a) calculation

- Indoor unit rated heating capacity: 6.3 kW
- Capacity compensation coefficient according to temperature conditions:
 1.04 (Calculated according to Outdoor 6°C WB / Indoor 19°C DB); (See page 16.)
 Indoor unit heating capacity: $6.3 \text{ kW} \times 1.04 \approx 6.6 \text{ kW}$
- Indoor unit total heating capacity calculation;
 indoor unit total heating capacity: $6.6 \text{ kW} \times 5 \text{ units} \approx \underline{33.0 \text{ kW}}$

<Outdoor unit maximum heating capacity> : Item (2) (b) calculation

- Outdoor unit rated heating capacity: 25.0 kW Correct the heating capacity based on the maximum capacity.
- Capacity compensation coefficient according to temperature conditions:
1.04 (Calculated according to Outdoor 6°C WB / Indoor 19°C DB); (See page 16.)
Outdoor unit heating capacity: 25.0 kW × 1.04 = 26.0 kW
- Capacity compensation coefficient according to piping length: 0.982 (calculated according to 60m length); (See page 17.)
26.0 kW × 0.982 ≈ 25.5 kW
- Capacity compensation coefficient according to height difference: 0.96 (calculated according to 20m difference); (See page 18.)
25.5 kW × 0.96 ≈ 24.5 kW
- Correction of heating capacity in relation to the frost on the outdoor unit heat exchanger:
1.0 (calculated according to 6°C WB); (See page 18.)
24.5 kW × 1.0 ≈ 24.5 kW.
- Capacity compensation coefficient according to indoor unit connected total capacity: 1.0 ← (56 × 5) / 224 ≈ 125% (See page 18.)
24.5 kW × 1.0 ≈ 24.5 kW.

<System heating capacity>: Item (2) (c) calculation

Compare the indoor unit total heating capacity and the outdoor unit maximum heating capacity. The smaller value is the actual system heating capacity.

- Indoor unit total heating capacity : 33.0 kW ⇒ System heating capacity: 24.5 kW
- Outdoor unit maximum heating capacity : 24.5 kW

<Indoor unit heating capacity compensation> : Item (2) (d) calculation

$$\frac{24.5 \text{ kW} \times 6.6 \text{ kW}}{33.0 \text{ kW}} \approx 4.9 \text{ kW}$$

(3) Capacity compensation coefficient

(a) Capacity compensation coefficient and power consumption compensation coefficient according to indoor and outdoor temperature conditions

1) Capacity compensation coefficient

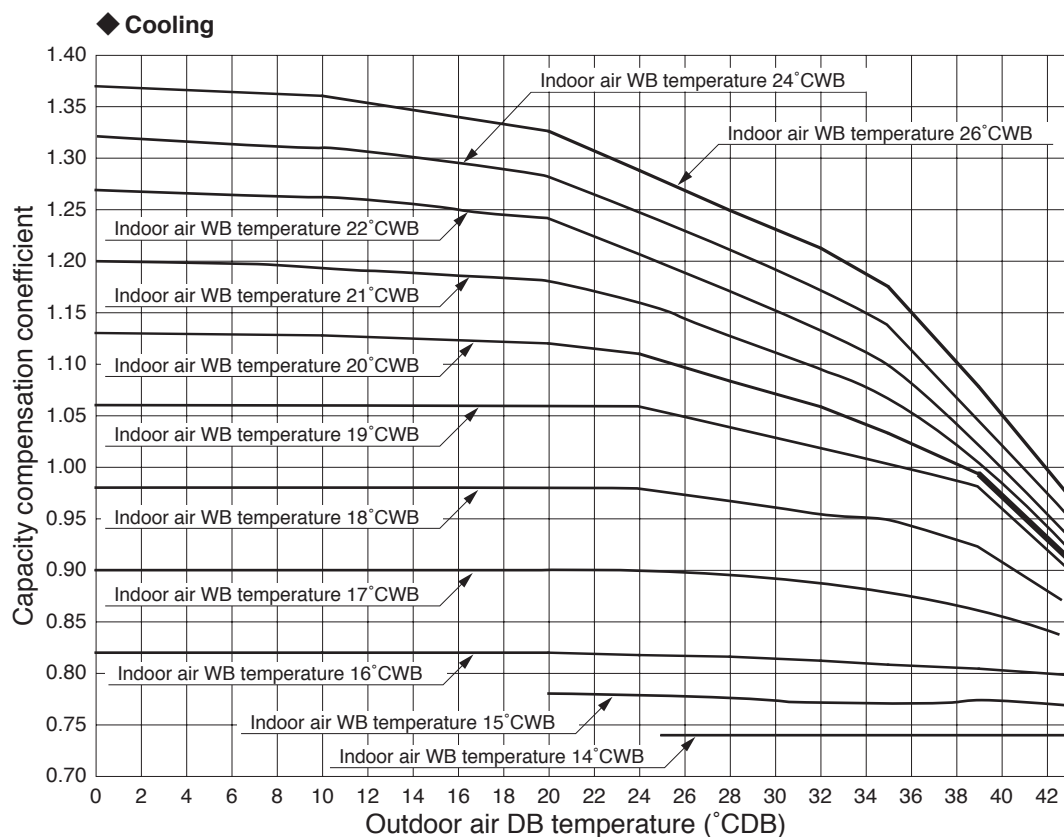

Notes (1) The above-mentioned table shows a typical condition among conditions to occur via controlling an air-conditioning equipment.
(2) When performing the cooling operation with the outdoor air temperature being -5°C or under, a windbreak fence must be installed.

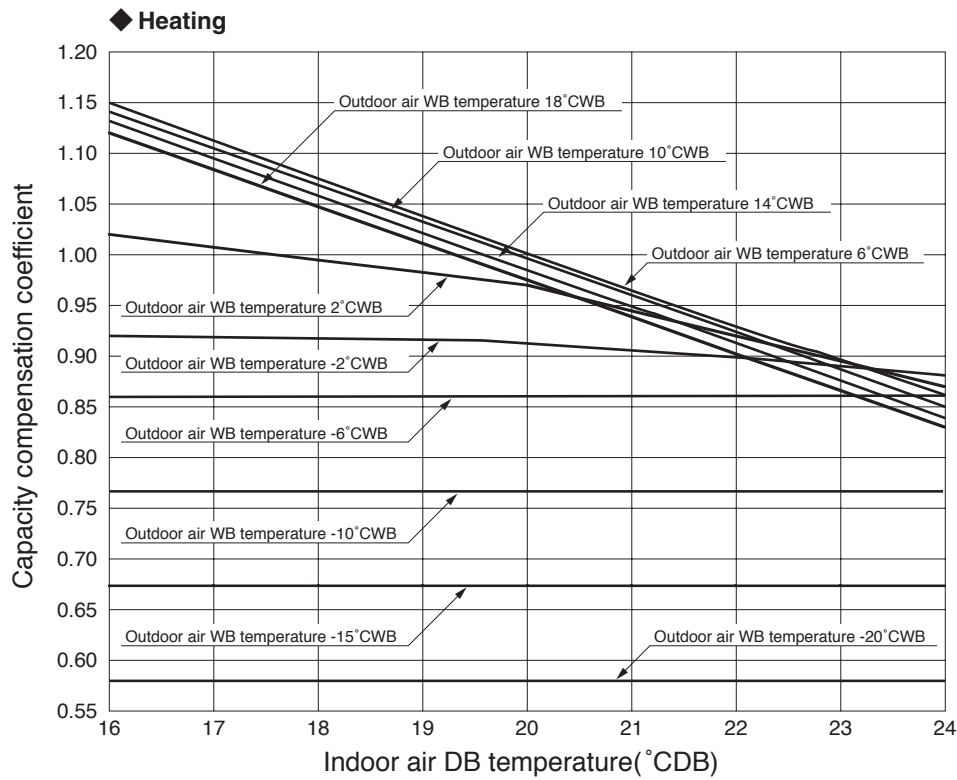

Note (1) The above-mentioned table shows a typical condition among conditions to occur via controlling an air-conditioning equipment.

2) Power consumption correction factor

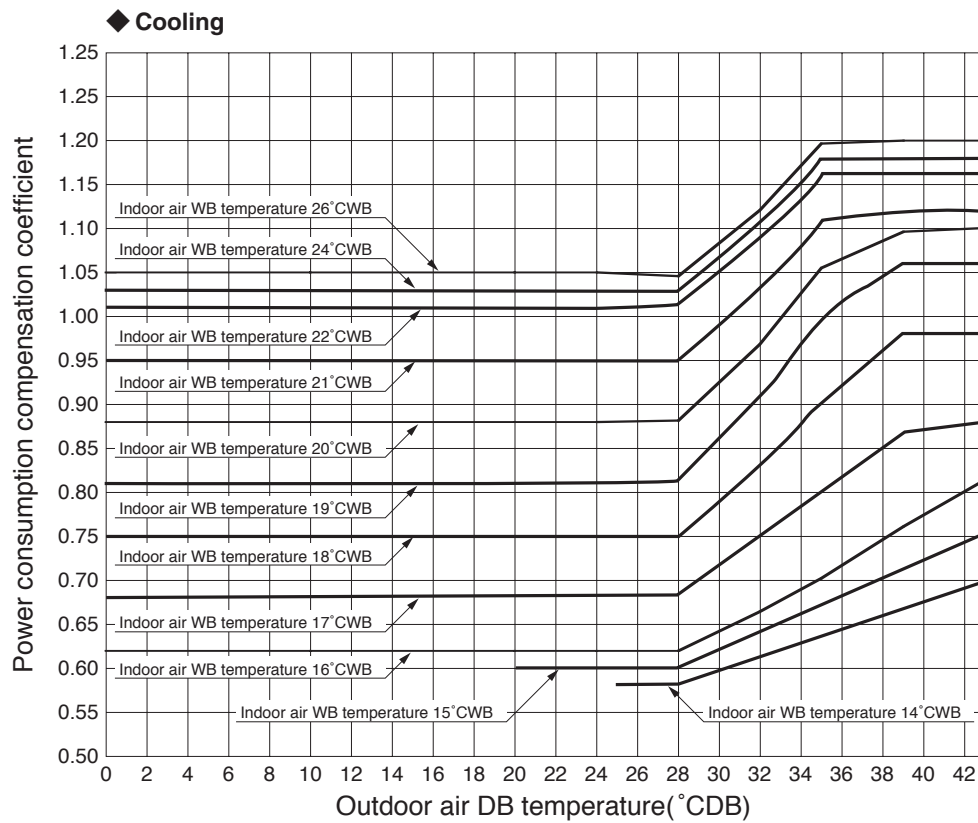

Note (1) The above-mentioned table shows a typical condition among conditions to occur via controlling an air-conditioning equipment.

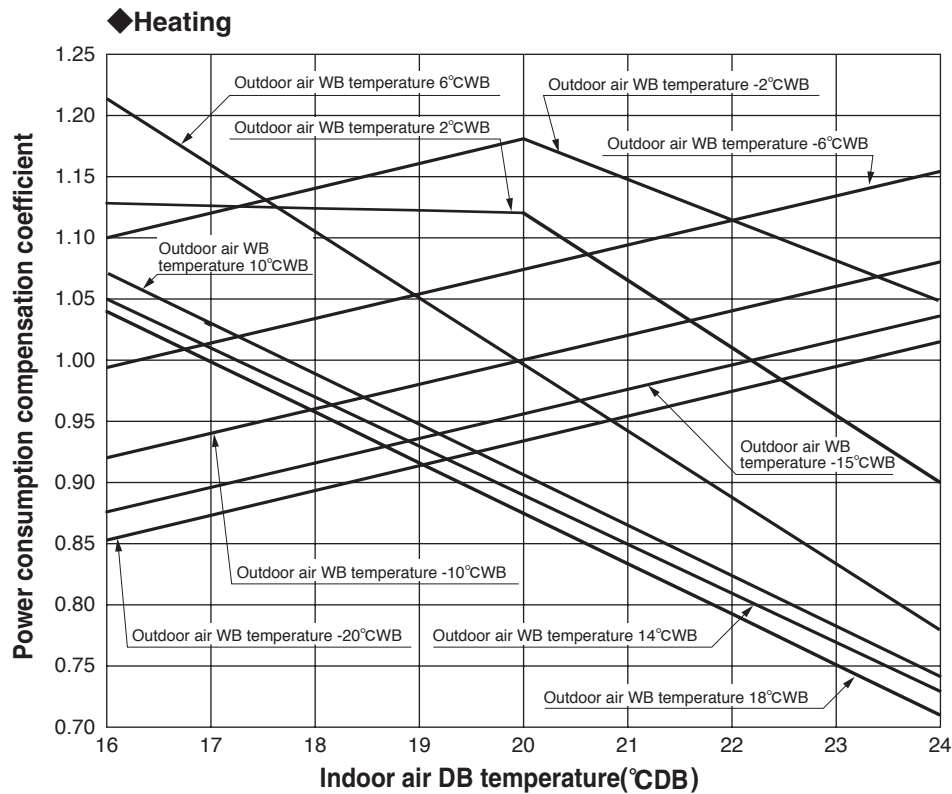

Note (1) The above-mentioned table shows a typical condition among conditions to occur via controlling an air-conditioning equipment.

(b) Correction of cooling and heating capacity in relation to one way length of refrigerant piping

(Note) This table is for reference only. If the refrigerant piping one way equivalent after the first branch is extended longer than 40m, it could drop further by about 10% in the worst case.

1) Cooling

Model : FDC224KXZME1

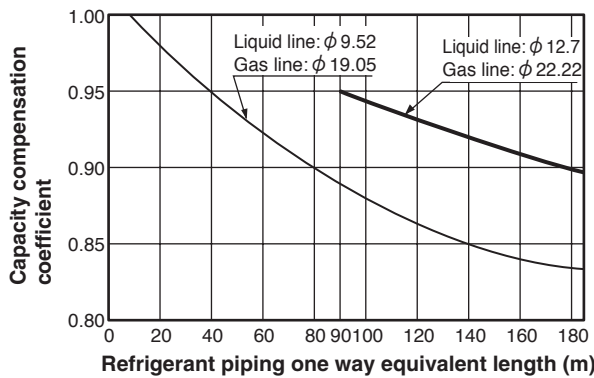

Model : FDC280KXZME1

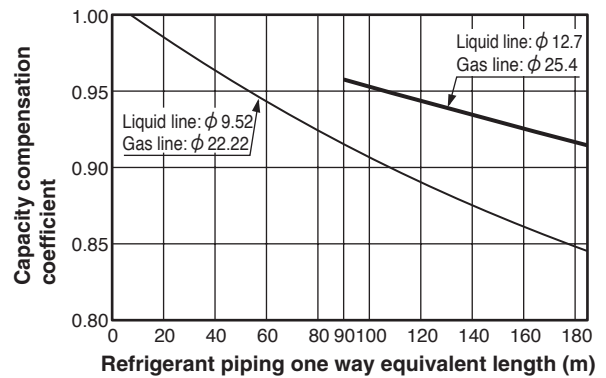

Model : FDC335KXZME1A

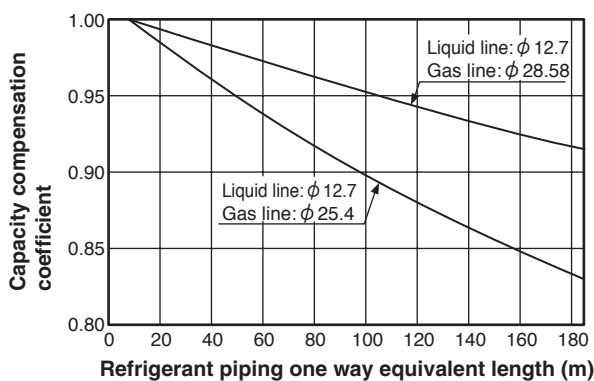

2) Heating

All models

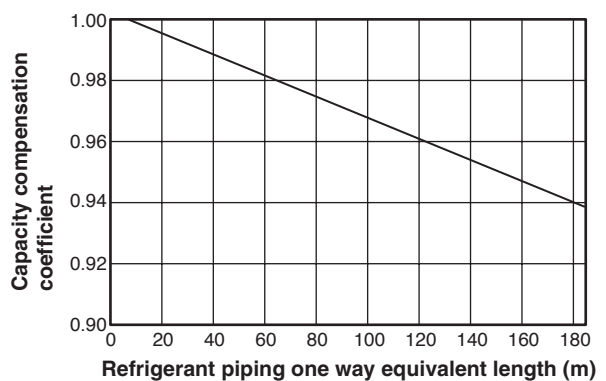

Note (1) Equivalent piping length can be obtained by calculating as follows.

$$\text{Equivalent piping length} = \text{Real gas piping length} + \text{Number of bends in gas piping} \times \text{Equivalent piping length of bends.}$$

Equivalent length of each joint

Unit : m/one part

Gas piping size	φ 9.52	φ 12.7	φ 15.88	φ 19.05	φ 22.22	φ 25.4	φ 28.58	φ 31.8
Joint (90° elbow)	0.15	0.20	0.25	0.30	0.35	0.40	0.45	0.55

- (c) When the outdoor unit is located at a lower height than the indoor unit in cooling operation and when the outdoor unit is located at a higher height than the indoor unit in heating operation, the following values should be subtracted from the values in the above table.

Height difference between the indoor unit and outdoor unit in the vertical height difference	5 m	10 m	15 m	20 m	25 m	30 m
Adjustment coefficient	0.99	0.98	0.97	0.96	0.95	0.94

Height difference between the indoor unit and outdoor unit in the vertical height difference	35 m	40 m	45 m	50 m
Adjustment coefficient	0.93	0.92	0.91	0.90

- (d) Correction of heating capacity in relation to the frost on the outdoor unit heat exchanger

Air inlet temperature of outdoor unit in °CWB	-20	-15	-13	-11	-9	-7	-5	-3	-1	1	3	5 or more
Adjustment coefficient	0.96	0.96	0.96	0.95	0.94	0.93	0.91	0.88	0.86	0.87	0.92	1

The correction factors will change drastically according to weather conditions. So necessary adjustment should be made empirically according to the weather data of the particular area.

- (e) The capacity compensation coefficient and power consumption compensation coefficient vary according to the total capacity of concurrently operating indoor units, as shown below.

(Note) This table shows typical values.

Models : FDC224KXZME1, 280KXZME1, 335KXZME1A

Capability compensation coefficient
Cooling

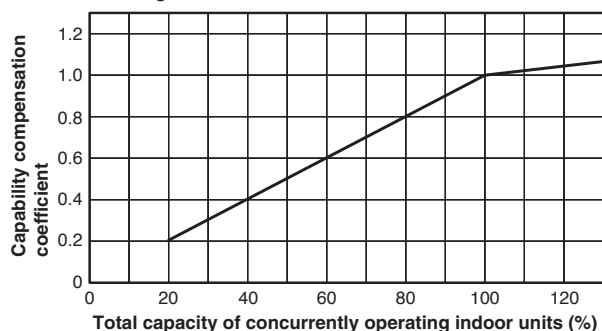

Heating

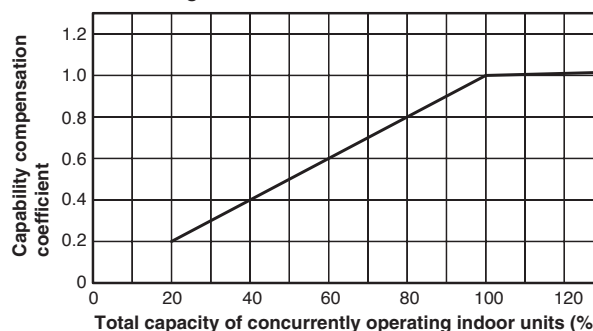

Power consumption compensation coefficient
Cooling

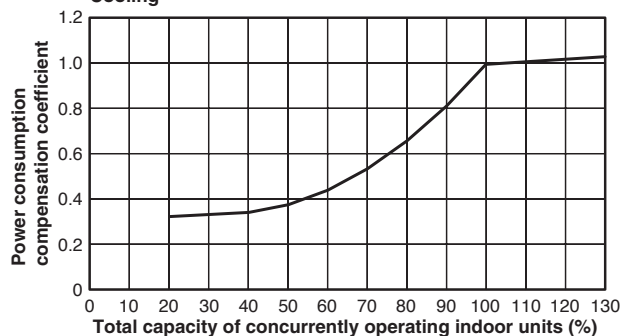

Heating

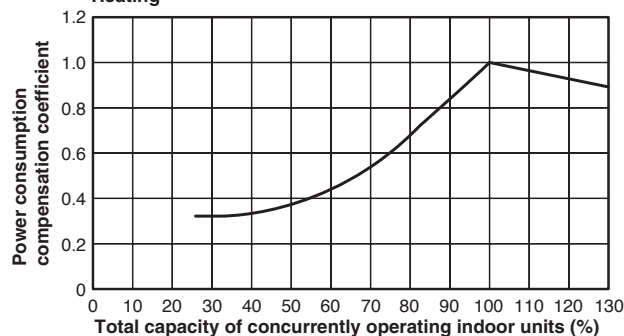

(Note) If the connecting capacity of the indoor unit exceeds 130%, consider the connecting capacity as 130%.

5. PIPING SYSTEM

Model FDC224KXZME1, 280KXZME1, 335KXZME1A

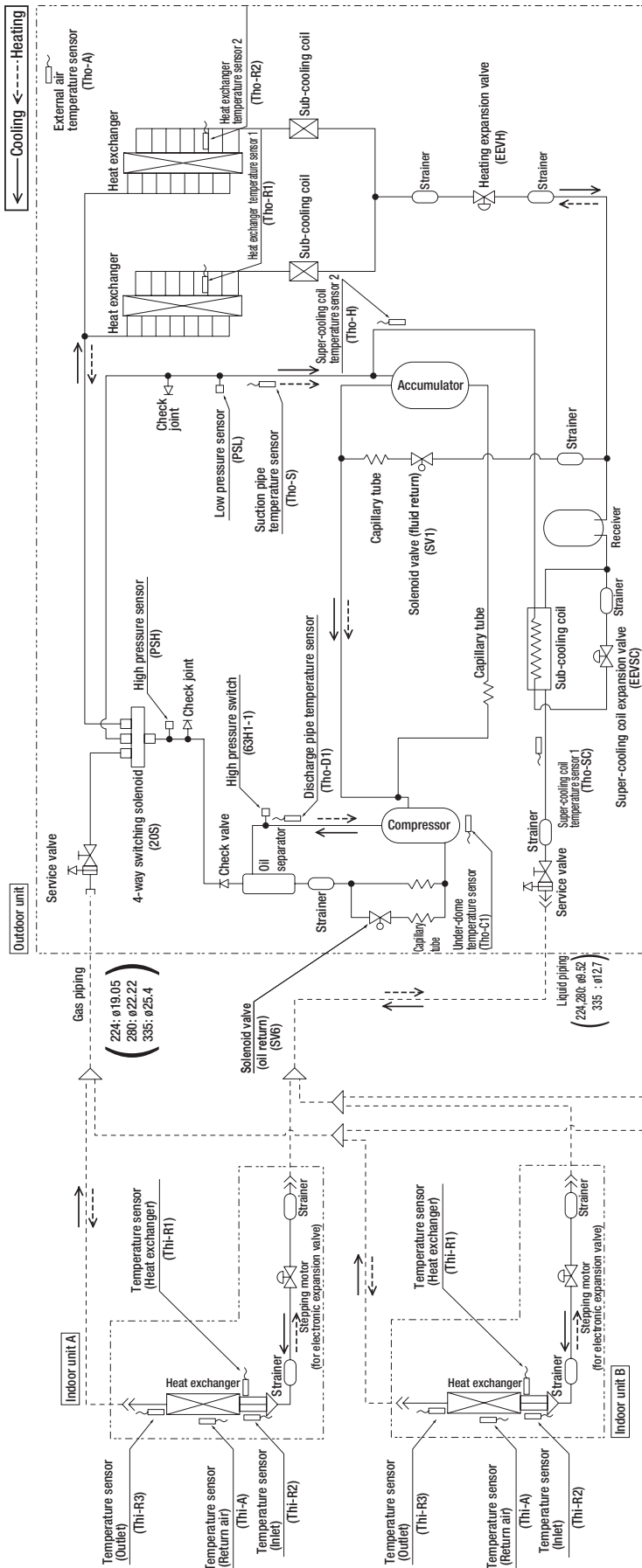

To next unit by turn

- Pressure switch setting value

Name	Setting value
High pressure switch (63H-1) [For protection]	4.15 open/3.15 close (MPa)
- Solenoid valve operation

Name	Control content
At inverter compressor start	: Open
During under-dome temperature control	: Open
During discharge temperature control	: Open
- Function of sensor

Low pressure sensor (PSL)	: Compressor control
High pressure sensor (PSH)	: Compressor control
Temperature sensor (THi-R1, R2)	: Heating operation : Indoor fan control
	: Cooling operation : Frost prevention
(THi-R3)	: Superheat control
	: Cooling superheat control
- Sensor (Tho-D1)

Sensor (Tho-A)	: For control of discharge pipe temperature
Sensor (Tho-R1, R2)	: For heating and cooling to low outdoor temperature, for control of defrost operation
Sensor (Tho-S)	: For control of defrost operation
Sensor (Tho-H)	: For control of suction pipe temperature
Sensor (Tho-SC)	: Super-cooling coil control during cooling
Sensor (Tho-H)	: Super-cooling coil control during cooling
Sensor (Tho-C1)	: Under-dome temperature control

6. APPLICATION DATA

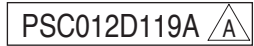

6.1 Installation of outdoor unit

Outdoor unit capacity
FDC224- 335

- ⊙ This installation manual deals with outdoor units and general installation specifications only. For indoor units, please refer to the respective installation manuals supplied with your units.
- ⊙ Please read this manual carefully before you set to installation work and carry it out according to the instructions contained in this manual.

Application data

When install the unit, be sure to check whether the selection of installation place, power source specifications, usage limitation (piping length, height differences between indoor and outdoor units, power source voltage and etc.) and installation spaces.

SAFETY PRECAUTIONS

- We recommend you to read this "SAFETY PRECAUTIONS" carefully before the installation work in order to gain full advantage of the functions of the unit and to avoid malfunction due to mishandling.
- The precautions described below are divided into [⚠️ WARNINGS] and [⚠️ CAUTIONS]. The matters with possibilities leading to serious consequences such as death or serious personal injury due to erroneous handling are listed in the [⚠️ WARNINGS] and the matters with possibilities leading to personal injury or damage of the unit due to erroneous handling including probability leading to serious consequences in some cases are listed in [⚠️ CAUTIONS]. **These are very important precautions for safety. Be sure to observe all of them without fail.**
- The meaning of "Marks" used here are as shown on the right.

Never do it under any circumstance. **Always do it according to the instruction.**

- Be sure to confirm no anomaly on the equipment by commissioning after completed installation and explain the operating methods as well as the maintenance methods of this equipment to the user according to the owner's manual.
- Keep the installation manual together with owner's manual at a place where any user can read at any time. Moreover if necessary, ask to hand them to a new user.
- This unit complies with EN61000-3-3.

For outdoor unit, EN61000-3-2 is not applicable as consent by the utility company or notification to the utility company is given before usage. (Only 224, 280)

For outdoor unit, EN61000-3-12 is not applicable as consent by the utility company or notification to the utility company is given before usage. (Only 335)

⚠️ WARNING

- Installation must be carried out by the qualified installer.
If you install the system by yourself, it may cause serious trouble such as water leaks, electric shocks, fire and personal injury, as a result of a system malfunction.
- Install the system in full accordance with the instruction manual.
Incorrect installation may cause bursts, personal injury, water leaks, electric shocks and fire.
- Use the original accessories and the specified components for installation.
If parts other than those prescribed by us are used, it may cause fall of the unit, water leaks, electric shocks, fire, refrigerant leak, substandard performance, control failure and personal injury.
- When installing in small rooms, take prevention measures not to exceed the density limit of refrigerant in the event of leakage accordance with ISO5149.
Consult the expert about prevention measures. If the density of refrigerant exceeds the limit in the event of leakage, lack of oxygen can occur, which can cause serious accidents.
- Ventilate the working area well in the event of refrigerant leakage during installation.
If the refrigerant comes into contact with naked flames, poisonous gas is produced.
- After completed installation, check that no refrigerant leaks from the system.
If refrigerant leaks into the room and comes into contact with an oven or other hot surface, poisonous gas is produced.
- Hang up the unit at the specified points with ropes which can support the weight in lifting for portage. And to avoid jolting out of alignment, be sure to hang up the unit at 4-point support.
An improper manner of portage such as 3-point support can cause death or serious personal injury due to falling of the unit.
- Install the unit in a location with good support.
Unsuitable installation locations can cause the unit to fall and cause material damage and personal injury.
- Ensure the unit is stable when installed, so that it can withstand earthquakes and strong winds.
Unsuitable installation locations can cause the unit to fall and cause material damage and personal injury.
- The electrical installation must be carried out by the qualified electrician in accordance with "the norm for electrical work" and "national wiring regulation", and the system must be connected to the dedicated circuit.
Power source with insufficient capacity and incorrect function done by improper work can cause electric shocks and fire.
- Be sure to shut off the power before starting electrical work.
Failure to shut off the power can cause electric shocks, unit failure or incorrect function of equipment.
- Be sure to use the cables conformed to safety standard and cable ampacity for power distribution work.
Unconformable cables can cause electric leak, anomalous heat production or fire.
- Use the prescribed cables for electrical connection, tighten the cables securely in terminal block and relieve the cables correctly to prevent overloading the terminal blocks.
Loose connections or cable mountings can cause anomalous heat production or fire.
- Arrange the wiring in the control box so that it cannot be pushed up further into the box. Install the service panel correctly.
Incorrect installation may result in overheating and fire.
- In connecting the power cable, make sure that no anomalies such as dust deposits, socket clogging or wobble are found and insert the plug securely.
Accumulation of dust, clogging on the socket, or looseness of plugging can cause electric shocks and fire.
- Be sure not to reuse existing refrigerant pipes.
Conventional refrigerant oil or chlorine contained in the conventional refrigerant which is remaining in the existing refrigerant pipes can cause deterioration of refrigerant oil of new unit. And 1.6 times higher pressure of R410A refrigerant than conventional one can cause burst of existing pipe, personal injury or serious accident.
- Do not perform brazing work in the airtight room
It can cause lack of oxygen.
- Use the prescribed pipes, flare nuts and tools for R410A.
Using existing parts (for R22 or R407C) can cause the unit failure and serious accidents due to burst of the refrigerant circuit.
- Tighten the flare nut by using double spanners and torque wrench according to prescribed method. Be sure not to tighten the flare nut too much.
Loose flare connection or damage on the flare part by tightening with excess torque can cause burst or refrigerant leaks which may result in lack of oxygen.
- Do not open the service valves for liquid line and gas line until completed refrigerant piping work, air tightness test and evacuation.
If the compressor is operated in state of opening service valves before completed connection of refrigerant piping work, you may incur frost bite or injury from an abrupt refrigerant outflow and air can be sucked into refrigerant circuit, which can cause burst or personal injury due to anomalously high pressure in the refrigerant.
- Do not put the drainage pipe directly into drainage channels where poisonous gases such as sulphide gas can occur.
Poisonous gases will flow into the room through drainage pipe and seriously affect the user's health and safety. It can also cause the corrosion of the indoor unit and resultant unit failure or refrigerant leak.
- Only use prescribed option parts. The installation must be carried out by the qualified installer.
If you install the system by yourself, it can cause serious trouble such as water leaks, electric shocks, fire.
- Do not perform any change of protective device itself or its setup condition
The forced operation by short-circuiting protective device of pressure switch and temperature control or the use of non specified component can cause fire or burst.
- Be sure to switch off the power source in the event of installation, inspection or servicing.
If the power source is not shut off, there is a risk of electric shocks, unit failure or personal injury due to the unexpected start of fan.
- Consult the dealer or an expert regarding removal of the unit.
Incorrect installation can cause water leaks, electric shocks or fire.
- Stop the compressor before closing valve and disconnecting refrigerant pipes in case of pump down operation.
If disconnecting refrigerant pipes in state of opening service valves before compressor stopping, you may incur frost bite or injury from an abrupt refrigerant outflow and air can be sucked, which can cause burst or personal injury due to anomalously high pressure in the refrigerant circuit.
- Ensure that no air enters in the refrigerant circuit when the unit is installed and removed.
If air enters in the refrigerant circuit, the pressure in the refrigerant circuit becomes too high, which can cause burst and personal injury.
- Do not run the unit with removed panels or protections
Touching rotating equipments, hot surfaces or high voltage parts can cause personal injury due to entrapment, burn or electric shocks.
- Be sure to fix up the service panels.
Incorrect fixing can cause electric shocks or fire due to intrusion of dust or water.
- Do not perform any repairs or modifications by yourself. Consult the dealer if the unit requires repair.
If you repair or modify the unit, it can cause water leaks, electric shocks or fire.

⚠️ CAUTION

- Use the circuit breaker for all pole with correct capacity.
Using the incorrect circuit breaker, it can cause the unit malfunction and fire.
- Take care when carrying the unit by hand.
If the unit weighs more than 20kg, it must be carried by two or more persons. Do not carry by the plastic straps, always use the carry handle when carrying the unit by hand. Use gloves to minimize the risk of cuts by the aluminum fins.
- Dispose of any packing materials correctly.
Any remaining packing materials can cause personal injury as it contains nails and wood. And to avoid danger of suffocation, be sure to keep the plastic wrapper away from children and to dispose after tear it up.
- Pay attention not to damage the drain pan by weld spatter when welding work is done near the indoor unit.
If weld spatter entered into the indoor unit during welding work, it can cause pin-hole in drain pan and result in water leakage. To prevent such damage, keep the indoor unit in its packing or cover it.
- Be sure to insulate the refrigerant pipes so as not to condense the ambient air moisture on them.
Insufficient insulation can cause condensation, which can lead to moisture damage on the ceiling, floor, furniture and any other valuables.
- Be sure to perform air tightness test by pressurizing with nitrogen gas after completed refrigerant piping work.
If the density of refrigerant exceeds the limit in the event of refrigerant leakage in the small room, lack of oxygen can occur, which can cause serious accidents.
- Perform installation work properly according to this installation manual.
Improper installation can cause abnormal vibrations or increased noise generation.
- Carry out the electrical work for ground lead with care.
Do not connect the ground lead to the gas line, water line, lightning conductor or telephone line's ground lead. Incorrect grounding can cause unit faults such as electric shocks due to short-circuiting. Never connect the grounding wire to a gas pipe because if gas leaks, it could cause explosion or ignition.
- Earth leakage breaker must be installed.
If the earth leakage breaker is not installed, it can cause fire or electric shocks.
- Do not use any materials other than a fuse with the correct rating in the location where fuses are to be used.
Connecting the circuit with copper wire or other metal thread can cause unit failure and fire.
- Do not install the unit near the location where leakage of combustible gases can occur.
If leaked gases accumulate around the unit, it can cause fire.
- Do not install the unit where corrosive gas (such as sulphurous acid gas etc.) or combustible gas (such as thinner and petroleum gases) can accumulate or collect, or where flammable substances are handled.
Corrosive gas can cause corrosion of heat exchanger, leakage of plastic parts and etc. And combustible gas can cause fire.
- Secure a space for installation, inspection and maintenance specified in the manual.
Insufficient space can result in accident such as personal injury due to falling from the installation place.
- When the outdoor unit is installed on a roof or a high place, provide permanent ladders and handrails along the access route and fences and handrails around the outdoor unit.
If safety facilities are not provided, it can cause personal injury due to falling from the installation place.
- Do not install the outdoor unit in a location where equipment that generates electromagnetic fields or high frequency harmonics (Equipment such as inverters, standby generators, medical high frequency equipments and telecommunication equipments can affect the system, and cause malfunctions and breakdowns. The system can also affect medical equipment and telecommunication equipment, and obstruct its function or cause jamming).
- Do not install the outdoor unit in a location where insects and small animals can inhabit.
Insects and small animals can enter the electric parts and cause damage or fire. Instruct the user to keep the surroundings clean.
- Do not use the base flame for outdoor unit which is corroded or damaged due to long periods of operation.
Using an old and damaged base flame can cause the unit falling down and cause personal injury.
- Do not install the unit in the locations listed below.
 - Locations where carbon fiber, metal powder or any powder is floating.
 - Locations where any substances that can affect the unit such as sulphide gas, chlorine gas, acid and alkaline can occur.
 - Vehicles and ships
 - Locations where cosmetic or special sprays are often used.
 - Locations with direct exposure of oil mist and steam such as kitchen and machine plant.
 - Locations where any machines which generate high frequency harmonics are used.
 - Locations with salty atmospheres such as coastlines
 - Locations with heavy snow (if installed, be sure to provide base flame and snow hood mentioned in the manual)
 - Locations where the unit is exposed to chimney smoke
 - Locations at high altitude (more than 1000m high)
 - Locations with ammoniac atmospheres (e.g. organic fertilizer)
 - Locations with calcium chloride (e.g. snow melting agent)
 - Locations where heat radiation from other heat source can affect the unit
 - Locations without good air circulation.
 - Locations with any obstacles which can prevent inlet and outlet air of the unit
 - Locations where short circuit of air can occur (in case of multiple units installation)
 - Locations where strong air blows against the air outlet of outdoor unit
- It can cause remarkable decrease in performance, corrosion and damage of components, malfunction and fire.
- Do not install the outdoor unit in the locations listed below.
 - Locations where discharged hot air or operating sound of the outdoor unit can bother neighborhood.
 - Locations where outlet air of the outdoor unit blows directly to an animal or plants. The outlet air can affect adversely to the plant etc.
 - Locations where vibration can be amplified and transmitted due to insufficient strength of structure.
 - Locations where vibration and operation sound generated by the outdoor unit can affect seriously.
 - Locations where vibration and operation sound is placed (in the wall or at the place near bed room)
 - Locations where an equipment affected by high harmonics is placed. (TV set or radio receiver is placed within 5m)
 - Locations where drainage cannot run off safely.
- It can affect surrounding environment and cause a claim
- Do not use the unit for special purposes such as storing foods, cooling precision instruments and preservation of animals, plants or art.
It can cause the damage of the items.
- Do not touch any buttons with wet hands
It can cause electric shocks
- Do not shut off the power source immediately after stopping the operation.
Wait at least 5 minutes, otherwise there is a risk of water leakage or breakdown.
- Do not control the system with main power switch.
It can cause fire or water leakage. In addition, the fan can start unexpectedly, which can cause personal injury.
- Do not touch any refrigerant pipes with your hands when the system is in operation.
During operation the refrigerant pipes become extremely hot or extremely cold depending the operating condition, and it can cause burn injury or frost injury.
- Do not operate the outdoor unit with any article placed on it.
You may incur property damage or personal injury from a fall of the article.
- Do not step onto the outdoor unit.
You may incur injury from a drop or fall.

Notabilia as a unit designed for R410A

- Do not use any refrigerant other than R410A. R410A will rise to pressure about 1.6 times higher than that of a conventional refrigerant.
- A unit designed for R410A has adopted a different size outdoor unit service valve charge port and a different size check joint provided in the unit to prevent the charging of a wrong refrigerant by mistake. The processed dimension of the flared part of a refrigerant pipe and a flare nut's parallel side measurement have also been altered to raise strength against pressure. Accordingly, you are required to arrange dedicated R410A tools listed in the table on the right before installing or servicing this unit.
- Do not use a charge cylinder. The use of a charge cylinder will cause the refrigerant composition to change, which results in performance degradation.
- In charging refrigerant, always take it out from a cylinder in the liquid phase.
- All indoor units must be models designed exclusively for R410A. Please check connectable indoor unit models in a catalog, etc. (A wrong indoor unit, if connected into the system, will impair proper system operation)



Dedicated R410A tools	
a)	Gauge manifold
b)	Charge hose
c)	Electronic scale for refrigerant charging
d)	Torque wrench
e)	Flare tool
f)	Protrusion control copper pipe gauge
g)	Vacuum pump adapter
h)	Gas leak detector

1. BEFORE BEGINNING INSTALLATION (Check that the models, power source specifications, piping, wiring are correct.)

Caution

- Be sure to read this manual before installation to follow the proper installation methods.
- When installing the indoor unit, read the installation manual of indoor unit.
- Option distribution parts are required for the piping (Branch pipe set, header set). For details, refer to the catalog, etc.
- Make sure to install the earth leakage breaker. (Select a product compatible with high frequency.)
- There is risk of damaging the compressor if the unit is operated while the discharge pipe temperature sensor, suction pipe temperature sensor, pressure sensor, etc. are removed. Never attempt to operation in such condition.
- With this air-conditioning system, room temperature may rise, depending on installation conditions, while indoor units are stopped, because small quantity of refrigerant flows into the stopped indoor units if heating operation is conducted on the system.

Accessory

Name	Quantity	Location of use	
Wire 	2	Insert this in CnG on the outdoor unit PCB when using the silencing mode or forced cooling mode	Secured in the control box with adhesive tape.
Edging 	1	Use it for protection of a knock-out hole.	It is attached to the bracket with an adhesive tape in the proximity of the service valve.
Attached pipe 	1	Use this when connecting gas pipe.	Attached on the base below the service valve.
Instruction manual	1	When the installation work is completed, give instructions to the customer and ask him/her to keep it.	Attached on the base below the service valve.

Combination pattern

- Combination pattern of outdoor units, number of indoor units connected and capacity of connection are as show in the table at right.
- It can be used in combination with the following indoor unit.

Indoor unit	Remote control	Connection OK/NO
FD \bigcirc Δ Δ KXE6	RC-E3 (2 cores), RC-E4 (2 cores), RC-E5 (2 cores), RC-EX1A (2 cores)	OK
FD \bigcirc Δ Δ KXE4R, KXE4BR, KXE5R	RC-E1R (3 cores)	NO
FD \bigcirc Δ Δ KXE4, KXE4(A), KXE4A	RC-E1 (3 cores)	NO

Outdoor unit		Indoor unit	
Capacity	Combination pattern	Number of units connected (unit)	Range of total capacity of connected indoor units
224	Single	1-22	112-336
280	Single	1-24	140-420
335	Single	1-24	167-502

[Items sold separately]

Refrigerant pipe distribution parts, which are not contained in the package, will be required for installation. As for refrigerant pipe distribution parts, we offer branching pipe sets (Model type: DIS) and header sets (Model type: HEAD) as parts used on the indoor side of piping. Please select one suiting your application. In selecting distribution parts, please also refer to "4. REFRIGERANT PIPING." If you are not sure which parts to select, please consult with your dealer or the manufacture. Use refrigerant branching pipe sets and header sets designed exclusively for R410A without fail.

2. INSTALLATION LOCATION (Obtain approval from the customer when selecting the installation area.)

2-1. Selecting the installation location

- Where air is not trapped.
- Where the installation fittings can be firmly installed.
- Where any object does not prevent inlet or outlet air.
- Out of the heat range of other heat sources.
- Where strong winds will not blow against the outlet air.
- A place where stringent regulation of electric noises is applicable.
- Where it is safe for the drain water to be discharged.
- Where noise and hot air will not bother neighboring residents.
- Where snow will not accumulate.
- A place where no TV set or radio receiver is placed within 5m. (If electrical interference is caused, seek a place less likely to cause the problem)
- Do not install the unit in places which exposed to sea breeze (e.g. coastal area) or calcium chloride (e.g. snow melting agent), exposed to ammonia substance (e.g. organic fertilizer).

Please note

- If there is a possibility of a short-circuit, then install a flex flow adapter.
- When installing multiple units, provide sufficient intake space so that a short-circuit does not occur.
- In areas where there is snowfall, install the unit in a frame or under a snow hood to prevent snow from accumulating on it. (Inhibition of collective drain discharge in a snowy country)
- Do not install the equipment in areas where there is a danger for potential explosive atmosphere.
- Install the equipment in a location that can sufficiently support the weight of the equipment.
- If a unit is installed into a special environment as shown below, there will be a danger that the corrosion of the outdoor unit or its malfunctioning is caused. If this is the case, please consult with the distributor from whom you have purchased the unit.
 - Where corrosive gas is generated (such as a hot-spring resort area).
 - Where the unit is subject to sea breezes (coastal area).
 - Where the unit is subject to oil mists.
 - Where equipment generating electromagnetic waves exists in the vicinity.
- When strong winds occur
 - Where it is likely that the unit is subjected to strong winds, provide wind guards according to the following guidelines. Strong winds can cause performance degradation, an accidental stop due to a rise of high pressure and a broken fan.

CAUTION

Please leave sufficient clearance around the unit without fail. Otherwise, a risk of compressor and/or electric component failure may arise.

- Place the unit outlet pipe perpendicular to the wind direction.

When installing units side by side, install the flex flow adaptor. (This is not required if a distance of 1,500 mm may be secured between the blowing outlet and the wall.)

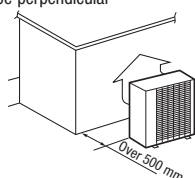

- Place so the direction of the air from the blowing outlet will be perpendicular to the direction of the wind.

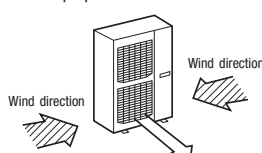

- When the foundation is not level, use wires to tie down the unit.

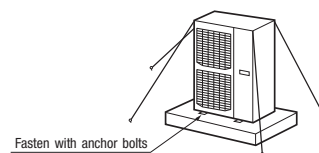

2-2. Installation space (Ex. servicing space)

- a) Minimum installation space
(Please select an installation point with due attention to the direction of installation of the refrigerant pipe)
(if the installation conditions shown in this drawing are not satisfied, please consult with your dealer or the manufacturer.)
- b) When two or more units are installed in a line, secure a service space of minimum 250 mm between each pair of neighboring units. The units can be operated, however, if they are separated by more than 10 mm each other. Where this minimum space is not available, it may be adapted by moving one of the units, for example, during the service work.
- c) Don't install at a place where it will be surrounded with walls in four directions.
Even when it is not surrounded with walls in four directions and it is met the installation conditions as shown by this figure, if there is risk of short-circuit, install the flex flow adaptor to prevent the short-circuit.
- d) There must be a 1-meter or larger space in the above.
- e) A barrier wall placed in front of the exhaust diffuser must not be higher than the unit.

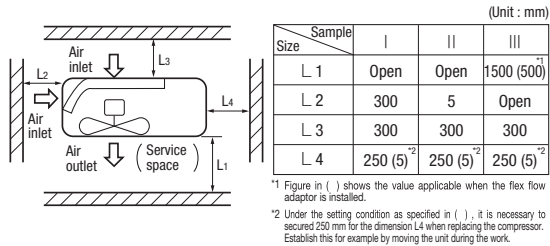

3. Unit delivery and installation

Caution Attach the ropes on the unit and carry it in avoiding displacement of gravity center. Improper slinging may cause the unit to lose balance and fall.

3-1. Delivery

- Deliver the unit in the packing to the specified installation place.
- To hoist the unit, attach a pair of textile ropes with cushion materials attached to protect it.

Request

Put cushion materials between the unit and the ropes to avoid damages.

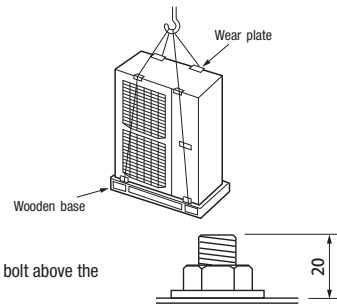

3-2. Cautions for installation

- Make sure to lock the fixing legs of outdoor unit with 4 pieces of anchor bolt (M10). Best margin of protrusion for bolt above the floor is 20mm.
- When installing the unit, make sure to lock its legs with the following bolts.

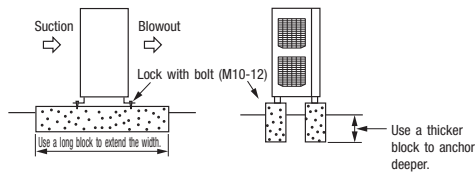
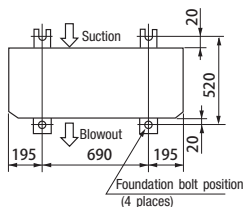

- The protrusion of an anchor bolt on the front side must be kept within 15 mm.
- Securely install the unit so that it does not fall over during earthquakes or strong winds, etc.
- Refer to the above illustrations for information regarding concrete foundations.
- Install the unit in a level area. (With a gradient of 5mm or less.)
Improper installation can result in a compressor failure, broken piping within the unit and abnormal noise generation.

Important In case that the unit operates in cooling mode, when the outdoor temperature is -5°C or lower, please equip a flex flow adapter and a snow guard hood (option) on the unit.

4. REFRIGERANT PIPING

4-1. Determination of piping specifications (Please select from the following matrix according to indoor unit specifications and installation site conditions)

(1) Limitation on use of pipes

- When arranging pipes, observe the restrictions on use concerning the longest distance of (1), total piping length, allowable pipe length from initial branching and allowable difference of height (difference between heads).
- Avoid any trap () or bump () in piping as they can cause fluid stagnation.
- Maximum length (To the furthest indoor unit) ... Actual length Less than 160 m (Actual length less than 185 m)
It is required to change the pipe diameter when the actual length exceeds 90 m.
Determine the size of main pipe, referring to the table of main pipe selection table of (3) (a).
- Total piping length 510 m or less
- Length of main pipe 130 m or less
- Allowable pipe length from initial branching 90 m or less
- Difference in pipe lengths between indoor units, however, is 40 m or less.
- Allowable difference in height (Difference of heads)
 - (a) When an indoor unit is positioned at a higher place 50 m or less
 - (b) When an outdoor unit is positioned at a lower place 40 m or less
 - (c) Difference of heights between indoor units in a system 18 m or less
 - (d) Difference of heights between initial branching and indoor unit ... 18 m or less

CAUTION

Make sure to install within the range of limitation. Otherwise, resulting malfunction of compressor may not be warranted. Observe always the limitation of use during installation.

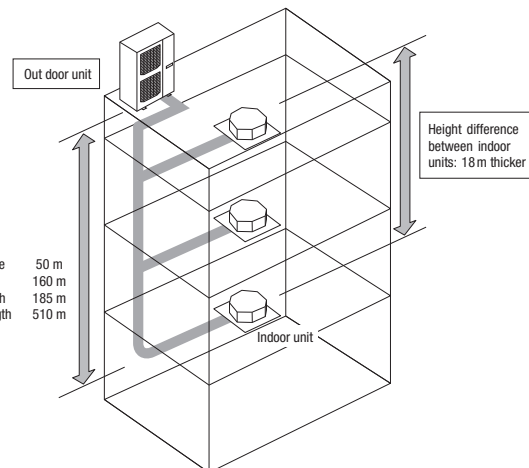

(2) Selection of pipe material

- Use pipes with the inside clean and free from any harmful sulfur, oxides, dirt, chips & oil, or moisture (contamination).
- Use following refrigerant pipes.
Material ... Phosphate deoxidation treated seamless pipe (C1220T-O, 1/2H, JIS H 3300) C1220T-1/2H for O.D. $\phi 19.05$ or more, or C1220T-O for $\phi 15.8$ or less
- Wall thickness and size - Select according to the guide for pipe size selection
(This product uses R410A. Since, in case of pipes in the size of $\phi 19.05$ or more, materials of -O lacks sufficient capacity to withstand pressure, make sure to use pipes of 1/2H material and thickness larger than the minimum thickness.)
- When a pipe is branched, make sure to use our branching set or header set.
- When setting branching pipes, take care of the mounting direction and consult carefully with the instruction manual.
- Regarding the handling of service valve, refer to 4-3 (1) Operating method of service valve.

(3) Pipe size selection

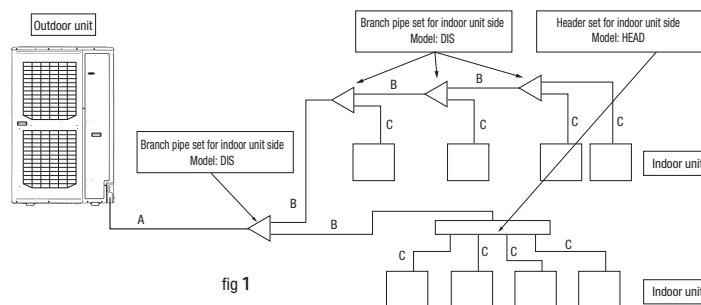

fig 1

(a) Main pipe (Between branch at outdoor unit side - initial branch at indoor unit side): Section A in Fig. 1

When the maximum length (to the furthest indoor unit from outdoor unit) is 90m or more (actual length), change the size of main pipe as shown by the following table.

Outdoor unit	Main pipe size (Ordinary)		Pipe size for actual length longer than 90m	
	Gas pipe	Liquid pipe	Gas pipe	Liquid pipe
224	φ 19.5×t1.0	φ 9.52×t0.8	φ 22.22×t1.0	ø12.7×t0.80
280	φ 22.22×t1.0		φ 25.4(φ 22.22)×t1.0	
335	φ 25.4(φ 22.22)×t1.0	φ 12.7×t0.8		

Make sure to use the attached pipes in the length as shown at left.

For ø19.05 or larger, use C1220T-1/2H material.

(b) Between initial branch at indoor unit side- indoor unit side: Section B in Fig. 1

Select from following table based on the total capacity of indoor units connected at the downstream side. However, it should never exceed the size of main pipe (Section A in Fig. 1).

Total capacity of indoor units	Gas pipe	Liquid pipe
Less than 70	φ 12.7 ×t1.0	φ 9.52×t0.8
70 - 180	φ 15.88×t1.0	
180 - 371	φ 19.05×t1.0 *1	φ 12.7×t0.8
371 - 540	φ 25.4(φ 22.22)×t1.0	φ 15.88×t1.0

For φ 19.05 or larger, use C1220T-1/2H material.

*1: When connecting indoor units of 280 at the downstream and the main gas pipe is of φ 22.22 or larger, use the pipe of φ 22.22x t1

(c) Between branching at indoor unit side - indoor unit side: Section C in Fig. 1

According to the table of pipe size for indoor unit. However, it should never exceed the size of main pipe (Section A in Fig. 1).

Indoor unit	Capacity	Gas pipe	Liquid pipe
		22, 28	φ 9.52×t0.8
36, 45, 56			
71, 80, 90, 112, 140, 160		φ 15.88×t1.0	φ 9.52×t0.8
224			
280			

For φ 19.05 or larger, use C1220T-1/2H material.

(4) Selection of the branch set for indoor unit side

(a) Selection of the branch pipe set

- Size of branch pipe varies depending on the capacity of connected indoor units (total capacity at downstream). Select it from the table at right.

Request

- Adjust the indoor unit and the size of branch pipe at the indoor unit side according to the size of pipe connected to indoor unit.
- Install the branch joint (both of gas and fluid) so that it will become "Horizontal branching" or "Vertical branching".



Total capacity at downstream	Branch pipe set
Less than 180	DIS-22-1G
180 - 371	DIS-180-1G
371 - 540	DIS-371-1G

(b) Selection of the header set

- Connect a plugged pipe (field provided) at the branch point (indoor unit connecting side) depending on the number of units connected.
- For the size of plugged pipe, refer to the header set (option item).

Request

- Adjust the header and indoor unit pipes to the size of pipes for connected indoor units.
- Install the header at the gas side to be "Horizontal branching" and, at the fluid side, that the branch is provided at the downstream side.
- Header is not allowed to receive indoor units of 224 or 280.

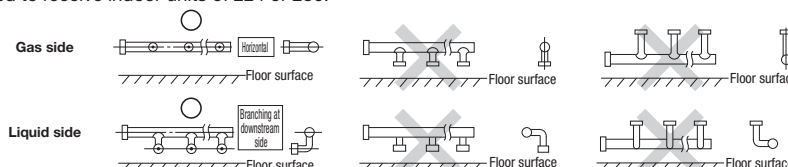

Total capacity at downstream	Header set model	Number of branches
Less than 180	HEAD4-22-1G	Max. 4 branches
180 - 371	HEAD6-180-1G	Max. 6 branches
371 - 540	HEAD8-371-2	Max. 6 branches

4-2. Piping work

(1) Pipe connecting position and pipe outgoing direction

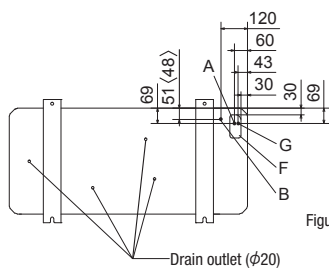
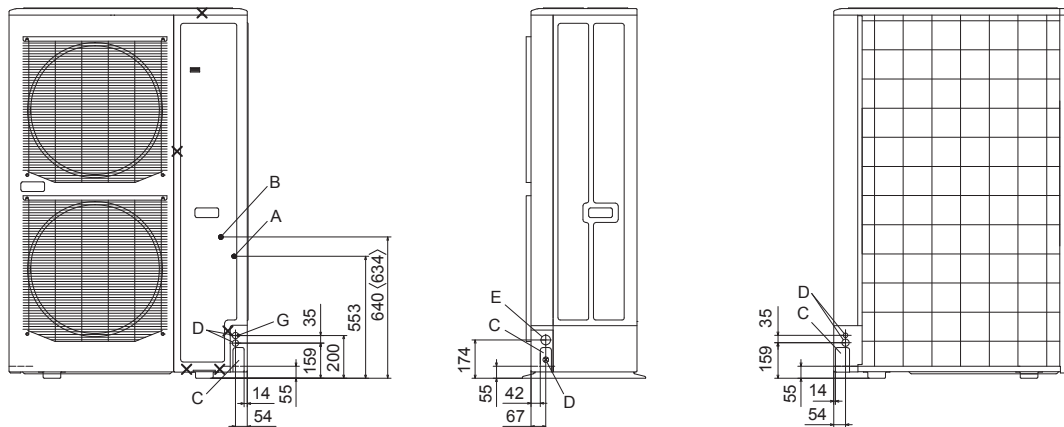
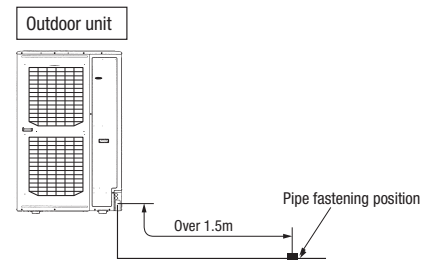
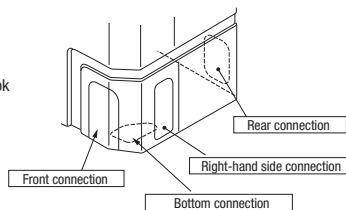
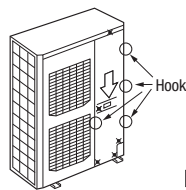

Figure in () is for 335

Legend	
A	Attached pipe connecting outlet at refrigerant gas side
B	Pipe connection outlet at liquid refrigerant side (Slot 50x94)
C	Refrigerant pipe outlet
D	Power cable outlet (φ 30)
E	Power cable outlet (φ 45)
F	Refrigerant pipe connection outlet (Slot 50x94)
G	Pipe connection outlet at gas refrigerant side



- First remove the five screws (X mark) of the service panel and push it down into the direction of the arrow mark and then remove it by pulling it toward you.
- The pipe can be laid in any of the following directions: side right, front, rear and downward.
- Remove a knock-out plate provided on the pipe penetration to open a minimum necessary area and attach an edging material supplied as an accessory by cutting it to an appropriate length before laying a pipe.
- In laying pipes on the installation site, cut off the casing's half blank that covers a hole for pipe penetration with nippers.
- If there is a risk of small animals entering from the pipe penetration part, close the part with some sealing material or the like (to be arranged on the installer's part).
- In the case of an installation using a collective drain system, use a port other than the bottom one to take out cables and pipes. If the bottom port is used, seal it thoroughly so that drain water may not spill out.
- Use an elbow (to be arranged on the user's part) to connect control valves to the piping.
- In anchoring piping on the installation site, give 1.5m or a longer distance between an outdoor unit and an anchoring point where the piping is secured as illustrated below. (A failure to observe this instruction may result in a pipe fracture depending on a method of isolating vibrations employed.)
- The pipe should be anchored every 1.5m or less to isolate the vibration.

(2) Field piping work

Important

- Please take care so that installed pipes may not touch components within a unit.
- **During the pipe installation at site, keep the service valves shut all the time.**
- Give **sufficient protections** (compressed and brazed or by an adhesive tape) **to pipe ends so that any water or foreign matters may not enter the pipes.**
- In bending a pipe, bend it **to the largest possible radius (at least four times the pipe diameter)**. Do not bend a pipe repeatedly to correct its form.
- An outdoor unit's pipe and refrigerant piping are to be flare connected. Flare a pipe after engaging a flare nut onto it. A flare size for R410A is different from that for conventional R407C. Although we recommend the use of flaring tools developed specifically for R410A, conventional flaring tools can also be used by adjusting the measurement of protrusion B with a protrusion control gauge.
- Be sure to use the accessory pipe for connection to the gas service valve. For details, refer to the installation manual of the accessory pipe.
- Tighten a flare joint securely **with two spanners**. Observe flare nut tightening torque specified in the table below.

CAUTION

If you tighten it without using double spanners, you may deform the service valve, which can cause an inflow of nitrogen gas into the outdoor unit.

Copper pipe outer diameter	Flare nut parallel side measurement: H (mm)	A	Flared pipe end: A (mm)		Copper pipe protrusion for flaring: B (mm)											
			Copper pipe outer diameter	A												
φ 6.35	17	0	9.1	<table border="1"> <thead> <tr> <th rowspan="2">Copper pipe outer diameter</th> <th colspan="2">In the case of a rigid (clutch) type</th> </tr> <tr> <th>With an R410A tool</th> <th>With a conventional tool</th> </tr> </thead> <tbody> <tr> <td>φ 6.35</td> <td rowspan="5">0- 0.5</td> <td rowspan="5">0.7- 1.3</td> </tr> <tr> <td>φ 9.52</td> </tr> <tr> <td>φ 12.7</td> </tr> <tr> <td>φ 15.88</td> </tr> <tr> <td>φ 15.88</td> </tr> </tbody> </table>	Copper pipe outer diameter	In the case of a rigid (clutch) type		With an R410A tool	With a conventional tool	φ 6.35	0- 0.5	0.7- 1.3	φ 9.52	φ 12.7	φ 15.88	φ 15.88
Copper pipe outer diameter	In the case of a rigid (clutch) type															
	With an R410A tool	With a conventional tool														
φ 6.35	0- 0.5	0.7- 1.3														
φ 9.52																
φ 12.7																
φ 15.88																
φ 15.88																
φ 9.52	22	-0.4	13.2													
φ 12.7	26		16.6													
φ 15.88	29		19.7													

For service valves both at the fluid and gas sides, fix the valve body and tighten to adequate torque as shown at right.

Service valve size (mm)	Tightening torque (N·m)	Tightening angle (°)	Recommended length of tool handle (mm)
φ 6.35 (1/4")	14-18	45-60	150
φ 9.52 (3/8")	34-42	30-45	200
φ 12.7 (1/2")	49-61	30-45	250
φ 15.88 (5/8")	68-82	15-20	300
φ 19.05 (3/4")	100-120	15-20	450

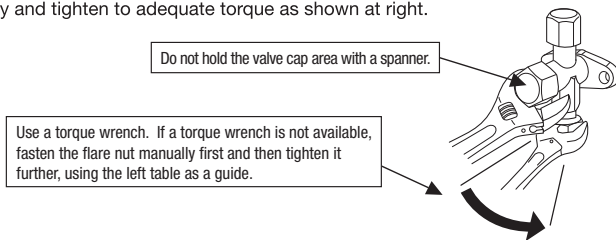

- Do not apply any oil on a flare joint.
- **Blazing must be performed under a nitrogen gas flow.** Without nitrogen gas, a large quantity of foreign matters (oxidized film) are created, causing a critical failure from capillary tube or expansion valve clogging.
- Brazing of the service valve and the pipes should be performed while cooling the valve body with a wet towel.
- Perform flushing. To flush the piping, charge nitrogen gas at about 0.02MPa with a pipe end closed with a hand. When pressure inside builds up to a sufficient level, remove the hand to flush. (in flushing a pipe, close the other end of the pipe with a plug).

Operation procedure

- ① **During the pipe installation at site, keep the service valves shut all the time.**
- ② **Blazing must be performed under a nitrogen gas flow.** Without nitrogen gas, a large quantity of foreign matters (oxidized film) are created, causing a critical failure from capillary tube or expansion valve clogging.

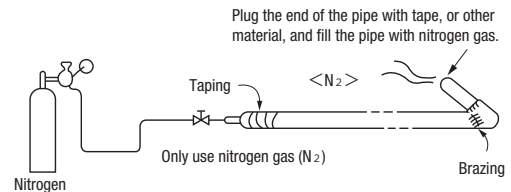

- ③ Give **sufficient protections** (compressed and brazed or with an adhesive tape) **so that water or foreign matters may not enter the piping.**

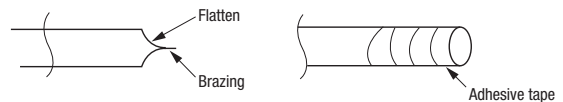

- ④ Perform flushing. To flush the piping, charge nitrogen gas at about 0.02MPa with a pipe end closed with a hand. When pressure inside builds up to a sufficient level, remove the hand to flush. (in flushing a pipe, close the other end of the pipe with a plug).

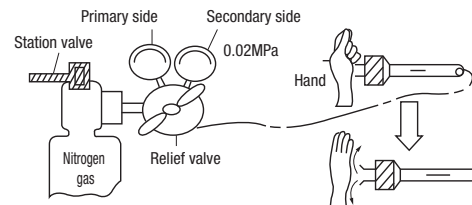

4-3. Air tightness test and air purge

(1) Air tightness test

- ① Although an outdoor unit itself has been tested for air tightness at the factory, please check the connected pipes and indoor units for air tightness from the check joint of the service valve on the outdoor unit side. While conducting a test, **keep the service valve shut all the time.**
- ② Since refrigerant piping is pressurized to the design pressure of a unit with nitrogen gas for testing air tightness, please connect instruments according to the drawing below. Under no circumstances should chlorine-based refrigerant, oxygen or any other combustible gas be used to pressurize a system. **Keep the service valve shut all the time.** Do not open it under any circumstances. **Be sure to pressurize all of the liquid, gas pipes.**
- ③ In pressurizing the piping, do not apply the specified level of pressure all at once, but gradually raise pressure.
 - a) **Raise the pressure to 0.5 MPa, and then stop. Leave it for five minutes or more** to see if the pressure drops.
 - b) **Then raise the pressure to 1.5 MPa, and stop. Leave it for five more minutes** to see if the pressure drops.
 - c) Then raise the pressure to the specified level (4.15 MPa), and record the ambient temperature and the pressure.
 - d) **If no pressure drop is observed with an installation pressurized to the specified level and left for about one day, it is acceptable.** When the ambient temperature changes 1°C, the pressure also changes approximately 0.01 MPa. The pressure, if changed, should be compensated for.
 - e) If a pressure drop is observed in checking e) and a) – d), a leak exists somewhere. Find a leak by applying bubble test liquid to welded parts and flare joints and repair it. After repair, conduct an air-tightness test again.
- ④ Always pull air from the pipes after the airtightness test.

CAUTION
Applying excessive pressure can cause an inflow of nitrogen gas into an outdoor unit.

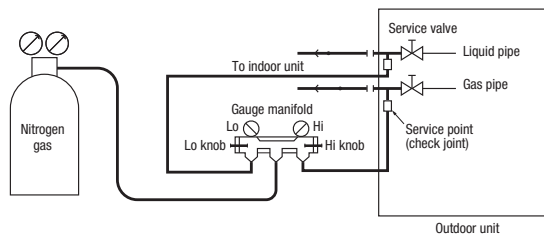

Standard torque at sections on service valve

Service valve size (mm)	Shaft tightening torque (N·m)	Cap tightening torque (N·m)	Check joint blind nut tightening torque (N·m)
φ 9.52 (3/8")	6-8	20-30	10-12
φ 12.7 (1/2")	14-16	25-35	10-12
φ 19.05 (3/4")	3	30-35	12-14

Securely tighten the cap and the blind nut after the adjustment. Avoid applying any excessive force when operating the shaft or when tightening the cap or blind nut. Otherwise, it could cause malfunction or leakage from the shaft, cap or blind nut.

▶ Allen wrench type

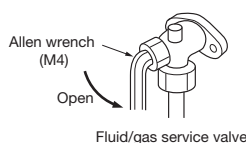

- Open the valve stem till it hits the stopper. No need to apply force more than that.
- After the adjustment, replace the blind nut as it was.

▶ Pin type

Remove the cap and adjust as shown below

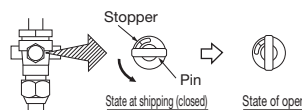

- After the adjustment, replace the cap as it was.

(2) Air purge

Perform the air purge from both the check joints at fluid side and gas side.

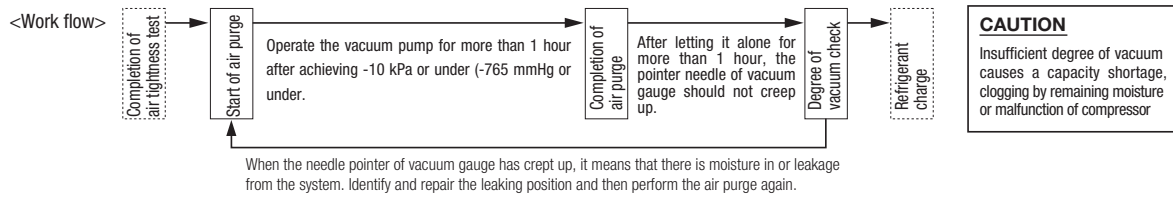

This product uses R410A. Take care of the following points.

- To avoid contamination with different type of oil, use separate tools depending on the type of refrigerant. It is prohibited especially to use the gauge manifold and the charge hose for different types of refrigerant (R22, R407C).
- Use a reverse flow prevention adaptor to prevent the contamination of refrigerant system with vacuum pump oil.

4-4. Additional charge of refrigerant

● Refrigerant must be in the state of fluid when charging.

● Make sure to use a measuring device when charging the refrigerant.

When it cannot charge whole required quantity because the outdoor unit is stopped, operate the unit in the test run mode and charge. (See Section 8 for the method of test run.) Operating the unit for a long period of time with insufficient quantity of refrigerant could cause malfunction on the compressor. (When charging while operating the unit, especially, complete the charge within 30 minutes.)

This unit contains 11.5 kg of refrigerant.

Calculate necessary quantity of additional charge with the following formula, and record the quantity of additionally charged refrigerant on the refrigerant quantity list provided on the back of service panel.

● Charge the additional refrigerant depending on the size and length of fluid pipe. Determine the quantity of additional charge by rounding the second place after decimal point, which means in the unit of 0.1 kg.

$$\text{Additional charge quantity (kg)} = 2.5 + (L3 \times 0.17) + (L4 \times 0.11) + (L5 \times 0.054) + (L6 \times 0.022)$$

Standard additional refrigerant quantity

Charge quantity for the refrigerant piping

Make sure to charge this quantity in addition to the charge quantity for the refrigerant piping.

L3: Tot al length of ø15.88 pipes (m), L4: Total length of ø12.7 pipes (m)

L5: Total length of ø0.952 pipes (m), L6: Total length of ø6.35 pipes (m)

Refrigerant pipe size	ø 15.88	ø 12.7	ø 9.52	ø 6.35	Remark
Additional charge quantity(kg/m)	0.17	0.11	0.054	0.022	

● This product uses R410A. Take care of the following points.

- To avoid contamination with different type of oil, use separate tools depending on the type of refrigerant. It is prohibited especially to use the gauge manifold and the charge hose for different types of refrigerant (R22, R407C).
- Type of refrigerant is indicated with the color painted on the container (Yellow for R140A). Sufficient care must be taken to use correct refrigerant only.
- Never use a charge cylinder. Otherwise, the composition of refrigerant may change when introducing R410A into the cylinder.
- Make sure to charge the refrigerant in the state of fluid.

● Request

Record the refrigerant quantity calculated based on the piping length in the refrigerant quantity list provided on the back of service panel.

THE LABEL FOR THE QUANTITY OF REFRIGERANT

● Charge specified quantity of refrigerant.

● Additional charge of refrigerant

1. The unit has been charged with 11.2 kg of refrigerant.

2. Enter the length of fluid pipe for each size in the table column. Charge the amount of refrigerant in the quantity of 24, the standard additional charge quantity (A) (B) the additional charge quantity for the refrigerant pipe which is indicated by table below.

● Standard additional refrigerant quantity (A)

● Charge quantity for refrigerant pipe (B)

● Total charge quantity of refrigerant (C)

Additional charge quantity for refrigerant pipe (B)

Additional charge quantity (C) = (A) + (B)

3. Total charge quantity of refrigerant

Calculate the total charge quantity of refrigerant from the charge quantity in the unit at shipping time (11.2 kg) and the additional charge quantity (C) and enter the result in the following column.

● Factory charge

● Additional charge

● Total charge

4. Total (Additional charge and) + Total Charge on the attached if Gas Label.

Refrigerant quantity label

CAUTION
Make sure to enter the data. The data is required at maintenance or service.

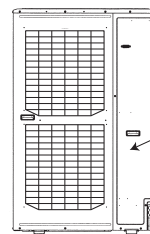

Attached on the back of service panel.

4-5. Heat insulation and moisture condensation proof

(1) Dress refrigerant pipes (both gas and liquid pipes) for heat insulation and prevention of dew condensation.

Improper heat insulation/anti-dew dressing can result in a water leak or dripping causing damage to household effects, etc.

(2) Use a heat insulating material that can withstand 120°C or a higher temperature. Poor heat insulating capacity can cause heat insulation problems or cable deterioration.

- All gas pipes must be securely heat insulated in order to prevent damage from dripping water that comes from the condensation formed on them during a cooling operation or personal injury from burns because their surface can reach quite a high temperature due to discharged gas flowing inside during a heating operation.
- Wrap indoor units' flare joints with heat insulating parts (pipe cover) for heat insulation (both gas and liquid pipes).
- Give heat insulation to both gas and liquid side pipes. Bundle a heat insulating material and a pipe tightly together so that no gaps may be left between them and wrap them together with a connecting cable by a dressing tape.
- Although it is verified in a test that this air-conditioning unit shows satisfactory performance under JIS condensation test conditions, both gas and liquid pipes need to be dressed with 20mm, or over, heat insulation materials additionally above the ceiling where relative humidity exceeds 70%.

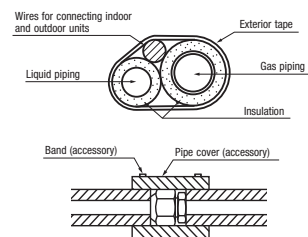

5. Drainage

- Where water drained from the outdoor unit may freeze, connect the drain pipe using optional drain elbow and drain grommet.
- Outdoor unit has 4 drain outlets on the bottom.
- When guiding drain water to a scupper, etc, install the parts on a flat stand (option item), blocks, or other.
- Connect the drain elbow as shown by the figure. Seal remaining holes with grommets.
- When draining water collectively, use holes for wires and pipes opened other than on the bottom. When this is impracticable, sufficiently seal the drain pipe to prevent water leakage.

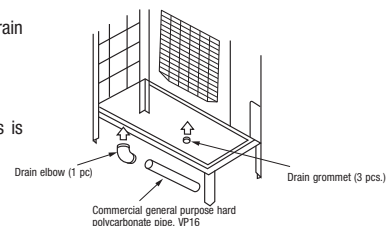

6. Electric wiring

Electrical installation work must be performed by an electrical installation service provider qualified by a power provider of the country. Electrical installation work must be executed according to the technical standards and other regulations applicable to electrical installations in the country.

⚠ Please install an earth leakage breaker without fail. The installation of an earth leakage breaker is compulsory in order to prevent electric shocks or fire accidents. (Since this unit employs inverter control, please **use an impulse withstanding type** to prevent an earth leakage breaker's false actuation.)

Please note

- Use only copper wires.
Do not use any supply cord lighter than one specified in parentheses for each type below.
 - braided cord (code designation 60245 IEC 51), if allowed in the relevant part 2;
 - ordinary tough rubber sheathed cord (code designation 60245 IEC 53);
 - flat twin tinsel cord (code designation 60227 IEC 41)
 - ordinary polyvinyl chloride sheathed cord (code designation 60227 IEC 53).
- Please do not use anything lighter than polychloroprene sheathed flexible cord (cord designation 60245 IEC57) for supply cords of parts of appliances for outdoor use.
- Use separate power source for the indoor and outdoor units.**
- The power source for indoor units in the same system should turn on and off simultaneously.**
- Ground the unit. Do not connect the grounding wire to a gas pipe, water pipe, lightning rod or telephone grounding wire. A grounding wire must be connected before connecting the power cable. Provide a grounding wire longer than the power cable. If improperly grounded, an electric shock or malfunction may result.
- The installation of an impulse withstanding type earth leakage breaker is necessary.** A failure to install an earth leakage breaker can result in an accident such as an electric shock or a fire. Do not turn on the power until the electrical work is completed. Be sure to turn off the power when servicing.
- Please do not use a condensive capacitor for power factor improvement under any circumstances. (It does not improve power factor, while it can cause an abnormal overheat accident.)
- For power source cables, use conduits.
- Do not lay electronic control cables (remote control and signaling lines) and other high current cables together outside the unit.** Laying them together can result in malfunctioning or a failure of the unit due to electric noises.
- Power cables and signaling lines must always be connected to the terminal block and secured by cable fastening clamps provided in the unit.
- Fasten cables so that they may not touch the piping, etc.
- When cables are connected, please make sure that all electrical components within the electrical component box are not free or not loose on the terminal connection** and then attach the cover securely. (Improper cover attachment can result in malfunctioning or a failure of the unit, if water penetrates into the box.)
- Make sure to use circuit breakers (earth leakage breaker and circuit breaker) of proper capacity. Use of breakers of larger capacity could result in trouble on components or fire accident. The circuit breaker should isolate all poles under over current.
- Install isolator or disconnect switch on the power source wiring in accordance with the local codes and regulations. The isolator should be locked in OFF state in accordance with EN60204-1.
- After maintenance, all wiring, wiring ties and the like, should be returned to their original state and wiring route, and the necessary clearance from all metal parts should be secured.

6-1. Wiring system drawing

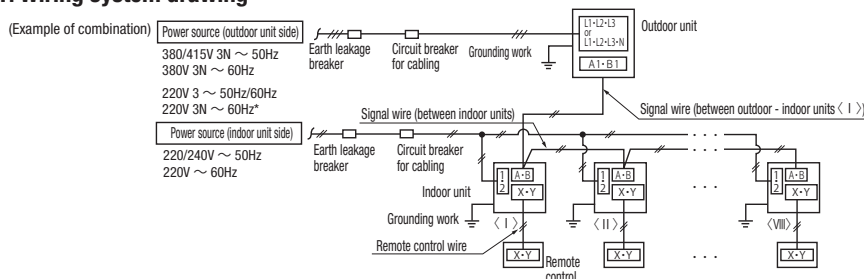

*Do not connect N-phase wire to the unit when the power source is 3 phase and 4-wires.

CAUTION

If the earth leakage breaker is exclusively for ground fault protection, then you will need to install a circuit breaker for wiring work.

6-2. Power source connection

(1) Method of leading out cables

- As shown on the drawing in Section 4-2, cables can be laid through the front, right, left or bottom casing.
- In wiring on the installation site, cut off a half-blank covering a penetration of the casing with nippers.
- In the case of an installation using a collective drain system, use a port other than the bottom one to take out cables and pipes. If the bottom port is used, seal it thoroughly so that drain water may not spill out.

(2) Notabilia in connecting power cables

- Connect the ground wire before you connect the power cable. When you connect a grounding wire to a terminal block, use a grounding wire longer than the power cable so that it may not be subject to tension.
- Do not turn on power until installation work is completed. Turn off power to the unit before you service the unit.
- Ensure that the unit is properly grounded.
- Always connect power cables to the power terminal block.
- To connect a cable to the power terminal block, use a round crimp contact terminal.
- If two cables are to be connected to one terminal, arrange cables in such a manner that you put their crimp contact terminals together back to back. Further, put the thinner cable above the thicker one in arranging cables for such connection.
- Use specified wires in wiring, and fasten them securely in such a manner that the terminal blocks are not subject to external force.
- In fastening a screw of a terminal block, use a correct-size driver.
- Fastening a screw of a terminal block with excessive force can break the screw.
- When electrical installation work is completed, make sure that all electrical components within the electrical component box are free of loose connector coupling or terminal connection.

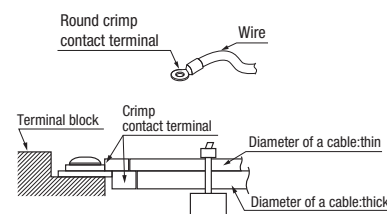

(3) Outdoor unit power source specification: 380/415V 3N~ 50Hz 380V 3N~ 60Hz 220V 3~ 60Hz

Model	Power source	Cable size for power source (mm ²)	Wire length (m)	Moulded-case circuit breaker (A)		Earth leakage breaker	Earth wire	
				Rated current	Switch capacity		Size (mm ²)	Screw type
224KXZME1 280KXZME1	3 phase 380/415V 50Hz 380V 60Hz	5.5	54	30	30	30A, 30mA less than 0.1 sec	2	M5
335KXZME1A								

Please note

- The method of laying cables has been determined pursuant to the Japanese indoor wiring regulations (JEC8001). (Please adapt it to the regulations in effect in each country.)
- For details, please refer to the installation manual supplied with the indoor unit.

6-3. How to connect signal cables

The communication protocol can be chosen from following two types. One of them is the conventional Superlink (hereinafter previous SL) and the other is the new Superlink II (hereinafter new SL). These two communication protocols have the following advantages and restrictions, so please choose a desirable one meeting your installation conditions such as connected indoor units and central control. When signal cables are connected into a network involving outdoor units, indoor units or central control equipment that do not support new SL, please select communications in the previous SL mode, even if the refrigerant system is separated from theirs.

Communication protocol	Conventional communication protocol (previous SL)	New communication protocol (new SL)
Outdoor unit setting (SW5-5)	ON	OFF (Factory default)
No. of connectable indoor units	Max. 48	Max. 128
No. of connectable outdoor units in a network	Max. 48	Max. 32
No. of connectable outdoor units	Up to 1000m	Up to 2,000 m for wires other than shielding wire Up to 1,500 m for 0.75 mm ² shielding wire (MVVS) Up to 1,000 m for 1.25 mm ² shielding wire (MVVS)
Signal cable (furthest length)	Up to 1000m	Up to 1000m
Connectable units to a network	Units not supporting new SL (FD○A△△KXE4.5 series) Units supporting new SL (FD○△△KXE6 series, FD○△△KXZ series) Can be used together.	Units supporting new SL (FD○△△KXE6 series, FD○△△KXZ series)

Note: For FDT224 and 280 models, calculate the number of units taking 1 indoor unit as 2 units for the sake of communication.

- **Signal cables are for DC 5 V. Never connect wires for 220/240 V or 380/415 V.** Protective fuse on the PCB will trip.

- ① Confirm that signal cables are prevented from applying 220/240 V or 380/415 V
- ② Before turning the power on, check the resistance on the signal cable terminal block. If it is less than 100Ω, power source cables may be connected to the signal cable terminal block.

When units of FD○△△KXE6 Series, FD○△△KXE1 series are connected:

Standard resistance value=5,100/Number of connected units.

When units of FD○A△△KXE4 and 5 Series only are connected:

Standard resistance value=9,200/Number of connected units.

When units of FD○△△KXE6 Series, FD○△△KXE1 series and units of FD○A△△KXE4 and 5 Series are connected in a mixture:

Standard resistance value=46,000/[(Number of connected FD○A△△KXE4 and 5 Series units x 5) + (Number of connected FD○△△KXE6 and KXZ Series units x 9)]

The number of connected units includes those of indoor units, outdoor units and SL devices.

If the resistance value is less than 100Ω, disconnect the signal cables temporarily to divide to more than one network, to reduce the number of indoor units on the same network, and check each network.

Indoor and outdoor units signal cables

- Connect the signal line between indoor unit and outdoor unit to A1 and B1.
- Connect the signal line between outdoor units to A2 and B2.
- Please use a shielded cable for a signal line and connect a shielding earth at all the indoor units and outdoor units.

(1) When one outdoor unit is used.

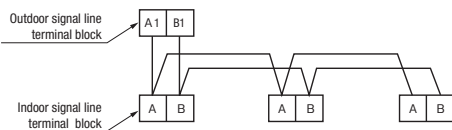

- Indoor and outdoor signal lines do not have a polarity. Any of the connections in the following illustration can be made.

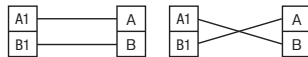

(1) The signal lines can also be connected using the method shown below.

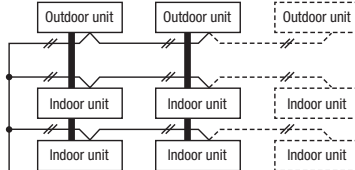

(2) When plural outdoor units are used

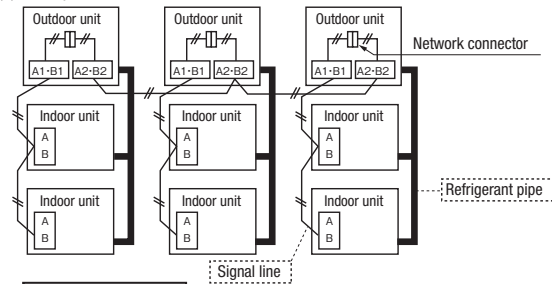

- ⚠ **Important** ○ Loop wiring prohibited.

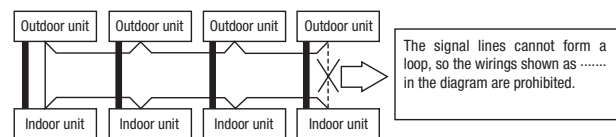

Power cable and signal cable connection

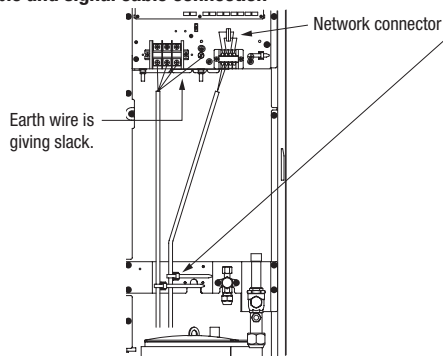

Wiring clamp

- Fix the cables not to exert external force to the terminal connection.
- Give adequate slack to cables in fastening them.
- Fix power cables separately from signal cables.

Outgoing cable direction

- As like the refrigerant pipe, it can be let out in any of 4 directions of right-hand side, front, rear and bottom.

Wiring label

- The wiring label is attached on the back of the service panel.

Request

- When connecting to the power source terminal block, use the crimp terminals for M5 as shown at right.
- When connecting to the signal terminal block, use the crimp terminals for M3.5 as shown at right.

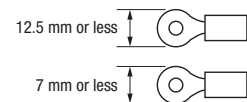

Remote control wiring specifications

- For the remote control the standard wire is 0.3mm². The max. length is up to 600m. When the wire is more than 100m long, use the wire shown in the table.
- Use 3 cores wires for FD○A△△KXE4 or 2 cores wires for FD○△△KXE6.

Length (m)	Wire size
Within 100 - 200	0.5mm ²
Within - 300	0.75mm ²
Within - 400	1.25mm ²
Within - 600	2.0mm ²

7. CONTROL SETTINGS

7-1. Unit address setting

This control system controls the controls of more than one air-conditioner's outdoor unit, indoor unit and remote control unit through communication control, using the microcomputers built in the respective controls. Address setting needs to be done for both outdoor and indoor units. Turn on power in the order of the outdoor units and then the indoor units.

Use 1 minute as the rule of thumb for an interval between them.

The communication protocol can be chosen from following two types. One of them is the conventional communication protocol (previous SL) and the other is the new communication protocol (new SL). These two communication protocols have their own features and restrictions as shown by Table 6-3. Select them according the indoor units and the central control to be connected.

When signal cables are connected into a network involving outdoor units, indoor units or central control equipment that do not support new SL, please select communications in the previous SL mode, even if the refrigerant system is separated from theirs.

When communication is established after setting addresses, check the communication protocol with the 7-segment display panel of the outdoor unit.

●Address setting methods

The following address setting methods can be used. The procedure for automatic address setting is different from the conventional one. Please use the automatic address setting function after reading this manual carefully.

Communication protocol		new SL		previous SL	
		Automatic	Manual	Automatic	Manual
When plural refrigerant systems are linked with signal lines (e.g., to implement central control)	Case 1 When signal lines linking plural refrigerant systems are provided between outdoor units. (When the network connector is disconnected, refrigerant systems are separated each other)	OK*1	OK	×	OK
	Case 2 When signal lines linking plural refrigerant systems are provided between indoor units.	×	OK	×	OK
When only one refrigerant system is involved (signal lines do not link plural refrigerant systems)		OK	OK	OK	OK

※1 Do not connect the signal line between outdoor units to A1 and B1. This may interrupt proper address setting. (Case 3)

Do not connect the signal line between indoor unit and outdoor unit to A2 and B2. This may interrupt proper address setting. (Case 4)

※2 In Case 2, automatic address setting is not available. Set addresses manually.

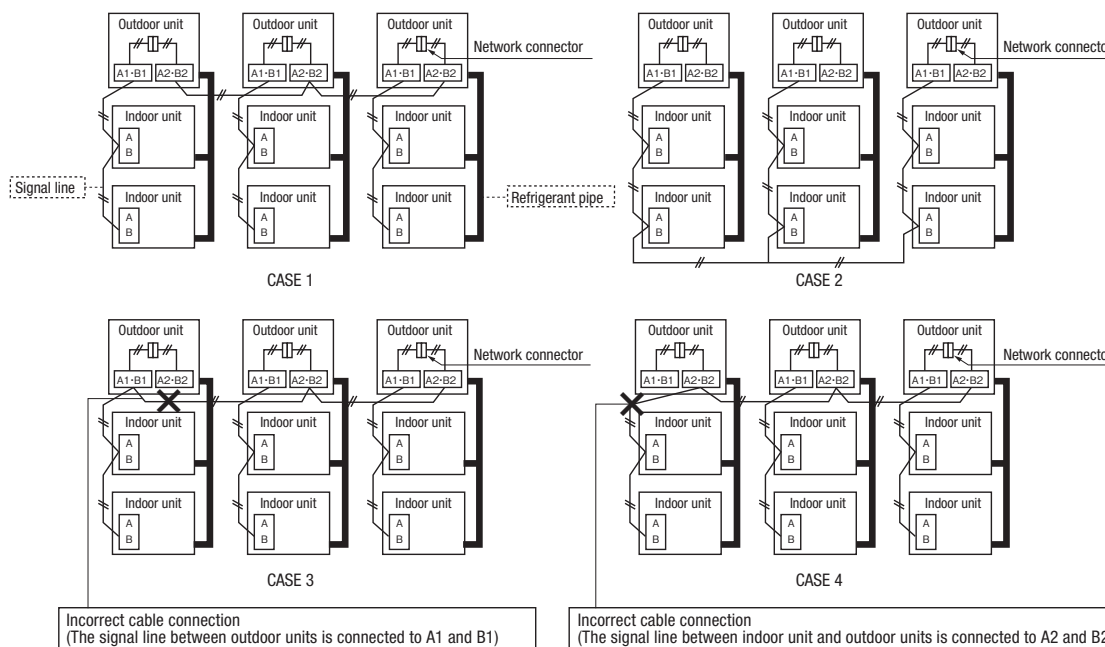

●Address No. setting

Set SW1 through 4 and SW5-2 provided on the PCB and SW1 & 2 provided on the outdoor unit PCB as shown in the drawings below.

Indoor PCB	SW1, 2 (blue)	For setting indoor No. (The ten's and one's)
	SW3, 4 (green)	For setting outdoor No. (The ten's and one's)
	SW5-2	Indoor No. switch (The hundred's Place) [OFF : 0, ON : 1]
Outdoor PCB	SW1, 2 (green)	For setting outdoor No. (The ten's and one's)

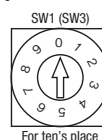

By inserting a flat driver (precision screwdriver) into this groove and turn the arrow to point a desired number.

●Summary of address setting methods (figures in [] should be used with previous SL)

	Units supporting new SL			Units NOT supporting new SL		
	Indoor unit address setting		Outdoor unit address setting	Indoor unit address setting		Outdoor unit address setting
	Indoor No. switch	Outdoor No. switch	Outdoor No. switch	Indoor No. switch	Outdoor No. switch	Outdoor No. switch
Manual address setting (previous SL/new SL)	000-127[47]	00-31[47]	00-31[47]	00-47	00-47	00-47
Automatic address setting for single refrigerant system installation (previous SL/new SL)	000	49	49	49	49	49
Automatic address setting for multiple refrigerant systems installation (with new SL only)	000	49	00-31	×	×	×

Do not set numbers other than those shown in the table, or an error may be generated.

Note: When units supporting new SL are added to a network using previous SL such as one involving FDOA△△KXE4 series units, choose previous SL for the communication protocol and set addresses manually. Since the models FDT224 and 280 have 2 PCBs per unit, set different indoor unit No. and switch on each PCB.

- An outdoor unit No., which is used to identify which outdoor unit and indoor units are connected in a refrigerant system, is set on outdoor unit PCB and indoor unit PCB. Give the same outdoor unit No. to all outdoor unit and indoor units connected in same refrigerant system.
- An indoor unit No. is used to identify individual indoor units. Assign a unique number that is not assigned to any other indoor units on the network.

Unless stated otherwise, the following procedures apply, when new SL is chosen for the communication protocol.
When previous SL is chosen, use figures shown in [] in carrying out these procedures.

Manual address setting Generally applicable to new SL/previous SL, use figures in [] with previous SL.

- ① Outdoor unit address setting
Set as follows before you turn on power. Upon turning on power, the outdoor unit address is registered.
Set the **Outdoor Unit No. switch to a number 00 - 31 [in the case of previous SL: 00 - 47]**.
Set a unique number by avoiding the numbers assigned to other outdoor units on the network.
- ② Indoor unit address setting
Set as follows before you turn on power. Upon turning on power, the indoor unit address is registered.
Set the **Indoor Unit No. switch to a number 000 - 127 [in the case of previous SL: 00 - 47]**.
Set the **Outdoor Unit No. switch** to the outdoor unit No. of the associated outdoor unit within the range of **00 - 31 [in the case of previous SL: 00 - 47]**.
Set a unique number by avoiding the numbers assigned to other indoor units on the network.
- ③ Turn on power in order from the outdoor unit to indoor units. Give a one-minute or longer interval for them.
* When there are some units not supporting new SL connected in the network, set SW5-5 to ON to choose the previous SL communication mode.
In the case of previous SL, the maximum number of indoor units connectable in a network is 48.

Automatic address setting Generally applicable to new SL/previous SL, use figures in [] with previous SL.

With new SL, you can set indoor unit addresses automatically even for an installation involving multiple refrigerant systems connected with same network, in addition to the conventional automatic address setting of a single refrigerant system installation.

However, an installation must satisfy some additional requirements such as for wiring methods, so please read this manual carefully before you carry out automatic address setting.

(1) In the case of a single refrigerant system installation (Generally applicable to new SL/previous SL, use figures in [] with previous SL.)

- ① Outdoor unit address setting
Set as follows before you turn on power.
Make sure that the **Outdoor Unit No. switch** is set to **49 (factory setting)**
- ② Indoor unit address setting
Set as follows before you turn on power.
Make sure that the **Indoor Unit No. switch** is set to **000 [in the case of previous SL: 49] (factory setting)**
Make sure that the **Outdoor Unit No. switch** is set to **49 (factory setting)**
- ③ Turn on power in order from the outdoor unit to indoor units. Give a one-minute or longer interval for them. Unlike the procedure set out in (2) below, you need not change settings from the 7-segment display panel.
- ④ Make sure that the number of indoor units indicated on the 7-segment display panel agrees with the number of the indoor units that are actually connected to the refrigerant system.

(2) In the case of a multiple refrigerant systems installation (Applicable to new SL only. In the case of previous SL, set addresses with some other method.)

(This option is available when the interconnection wiring among refrigerant systems is on the outdoor side and new SL is chosen as the communication protocol.)

Address setting procedure (perform these steps for each outdoor unit)

[STEP1] (Items set before turning on power)

- ① Outdoor unit address setting
Set as follows before you turn on power.
Set the **Outdoor Unit No. switch** to a number **00 - 31**. Set a unique number by avoiding the numbers assigned to other outdoor units on the network.
- ② Indoor unit address setting
Set as follows before you turn on power.
Make sure that the **Indoor Unit No. switch** is set to **000 (factory setting)**
Make sure that the **Outdoor Unit No. switch** is set to **49 (factory setting)**
- ③ Isolate the present refrigerant system from the network.
Disengage the **network connectors (white 2P)** of the outdoor units. (Turning on power without isolating each refrigerant system will result in erroneous address setting.)

[STEP2] (Power on and automatic address setting)

- ④ Turn on power to the outdoor unit
Turn on power in order from the outdoor unit to indoor units. Give a one-minute or longer interval for them.
- ⑤ Select and enter "1" in P31 on the 7-segment display panel of each outdoor unit to input "Automatic address start."
- ⑥ Input a starting address and the number of connected indoor units.
Input a starting address in P32 on the 7-segment display panel of each outdoor unit.
- ⑦ When a starting address is entered, the display indication will switch back to the "Number of Connected Indoor Units Input" screen.
Input the number of connected indoor units from the 7-segment display panel of each outdoor unit. Please input the number of connected indoor units for each outdoor unit. (You can input it from P33 on the 7-segment display panel.) When the number of connected indoor units is entered, the 7-segment display panel indication will switch to "AUX" and start flickering.

[STEP3] (Automatic address setting completion check)

- ⑧ Indoor unit address determination
When the indoor unit addresses are all set, the 7-segment display panel indication will switch to "AUE" and start flickering.
If an error is detected in this process, the display will show "A○○."
Check the 7-segment display panel of each outdoor unit.
Depending on the number of connected indoor units, it may take **about 10 minutes** before the indoor unit addresses are all set.

[STEP4] (Network definition setting)

- ⑨ Network connection
When you have confirmed an "AUE" indication on the display of each outdoor unit, **engage the network connectors** again.
- ⑩ Network polarity setting
After you have made sure that the network connectors are engaged in ⑧, select and enter "1" in P34 on the 7-segment display panel of **any outdoor unit (on only 1 unit)** to specify network polarity.
- ⑪ Network setting completion check
When the network is defined, "End" will appear on the 7-segment display panel. An "End" indication will go off, when some operation is made from the 7-segment display panel or 3 minutes after.

	STEP1	STEP2	STEP3	STEP4
Indoor unit power source	② OFF	④ ON	—	—
Outdoor unit power source	① OFF	④ ON	—	—
Indoor unit (indoor/outdoor No.SW)	② indoor000/outdoor 49 (factory setting)	—	—	—
Outdoor unit (outdoor No.SW)	① 01,02(Ex)	—	—	—
Network connectors	③ Disconnect(each outdoor unit)	—	—	⑨ Connect(each outdoor unit)
Start automatic address setting	—	⑤ Select "Automatic Address Start" on each outdoor unit.	—	—
Set starting address	—	⑥ outdoor 01:[01](Ex) outdoor 02:[04](Ex)	—	—
Set the number of indoor unit	—	⑦ outdoor 01:[03](Ex) outdoor 02:[03](Ex)	—	—
Polarity setting	—	—	—	⑩ Set in P34 on the 7-segment display panel of any outdoor unit.
7-segment display	—	⑦ [AUX] (Blink)	⑧ "AUE"(blink), or "A○○" in error events.	⑪ [End]

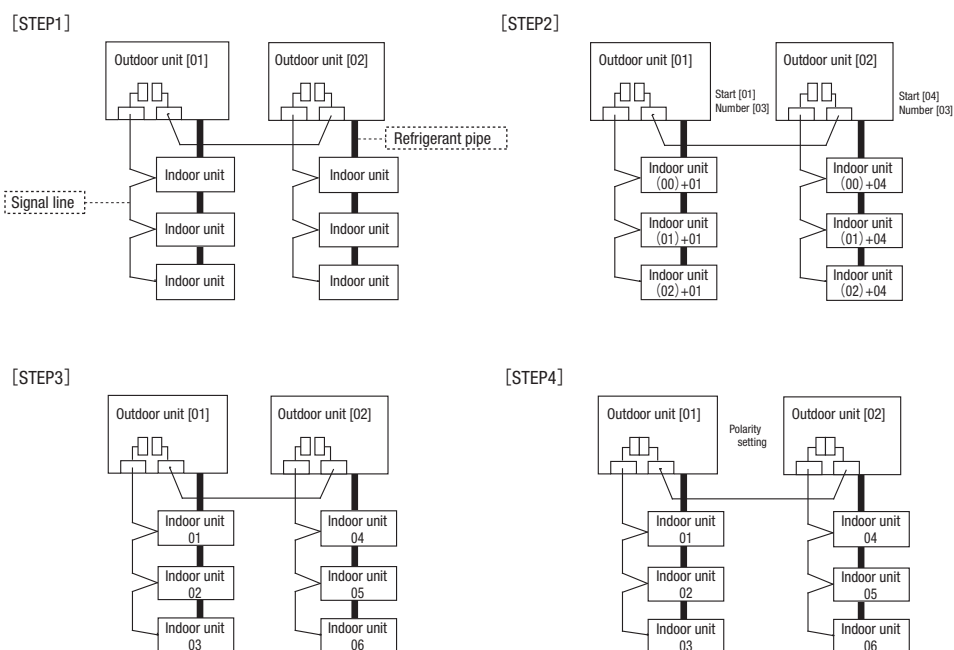

- Within a refrigerant system, indoor units are assigned addresses in the order they are recognized by the outdoor unit. Therefore, they are not necessarily assigned addresses in order from the nearest to the outdoor unit first as depicted in drawings above.
- Make sure that power has been turned on to all indoor units.
- When addresses are set, you can have the registered indoor unit address No.'s and the outdoor unit address No. displayed on the remote control unit by pressing its Inspection switch.
- Automatic address setting can be used for an installation in which plural indoor units are controlled from one remote control unit.
- Once they are registered, addresses are stored in microcomputers, even if power is turned off.
- If you want to change an address after automatic address setting, you can change it from the remote control unit with its "Address Change" function or by means of manual setting. Set a unique address by avoiding the address assigned to other indoor unit on the network when the address is changed.
- Do not turn on power to central control equipment until automatic address setting is completed.
- When addresses are set, be sure to perform a test run and ensure that you can operate all indoor and outdoor units normally. Also check the addresses assigned to the indoor units.

Address change (available only with new SL)

"Address Change" is used, **when you want to change an indoor unit address assigned with the "Automatic Address Setting" function from a remote control unit.** Accordingly, the conditions that permit an address change from a remote control unit are as follows.

	Indoor unit address setting		Outdoor unit address setting
	Indoor No.switch	Outdoor No.switch	Outdoor No.switch
Automatic address setting for single refrigerant system installation	000	49	49
Automatic address setting for multiple refrigerant systems installation	000	49	00-31

If "CHANGE ADD. ▼" is selected with some addresses falling outside these conditions, the following indication will appear for 3 seconds on the remote control "INVALID OPER".

Operating procedure

(1) When single indoor unit is connected to the remote control.

Item	Operation	Display
1 Address change mode	① Press the AIR CON No. switch for 3 seconds or longer.	[CHANGE ADD.▼]
	② Each time when you press the \blacklozenge switch, the display indication will be switched.	[CHANGE ADD.▼] ⇔[MASTER I/U▲]
	③ Press the Set switch when the display shows "CHANGE ADD. ▼" and then start the address change mode, changing the display indication to the "Indoor Unit No. Setting" screen from the currently assigned address.	[I/U 001 O/U 01] (1sec.) →[\blacklozenge SET I/U ADD.] (1sec.) →[I/U 001 \blacklozenge] (Blink)
2 To set a new indoor unit No.	④ Set a new indoor unit No. with the \blacklozenge switch. A number indicated on the display will increase or decrease by 1 upon pressing the ▲ or ▼ switch respectively.	[I/U 000▲] ⇔[I/U 001 \blacklozenge] ⇔[I/U 002 \blacklozenge] ⇔ . . . ⇔[I/U 127▼]
	⑤ After selecting an address, press the Set switch, and then the indoor unit address No. is defined.	[I/U 002] (2sec.)
3 To set a new outdoor unit No.	⑥ After showing the defined indoor address No. for 2 seconds, the display will change to the "Outdoor Address No. Setting" screen. The currently assigned address is shown as a default value.	[I/U 002] (2sec Lighting) →[\blacklozenge SET O/U ADD.] (1sec.) →[O/U 01 \blacklozenge] (Blink)
	⑦ Set a new outdoor unit No. with the \blacklozenge switch. A number indicated on the display will increase or decrease by 1 upon pressing the ▲ or ▼ switch respectively.	[O/U 00▲] ⇔[O/U 01 \blacklozenge] ⇔[O/U 02 \blacklozenge] ⇔ . . . ⇔[O/U 31▼]
	⑧ After selecting an address, press the Set switch, and then the outdoor unit No. and the indoor unit No. are defined.	[I/U 002 O/U 02] (2sec. Lighting) →[SET COMPLETE] (2sec. Lighting) →Returns to normal condition.

(2) When plural indoor units are connected to the remote control.

When plural indoor units are connected, you can change their addresses without altering their cable connection.

Item	Operation	Display
1 Address change mode	① Press the AIR CON Unit No. switch for 3 seconds or longer.	[CHANGE ADD.▼]
	② Each time when you press the \blacklozenge switch, the display indication will be switched.	[CHANGE ADD.▼] ⇔[MASTER I/U▲]
	③ Press the Set switch when the display shows "CHANGE ADD. ▼" The lowest indoor unit No. among the indoor units connected to the remote control unit will be shown.	[\blacklozenge SELECT I/U] (1sec.) →[I/U 001 O/U 01▲] (Blink)
2 Selecting an indoor unit to be changed address	④ Pressing the \blacklozenge switch will change the display indication cyclically to show the unit No.'s of the indoor units connected to the remote control and the unit No.'s of the outdoor units connected with them.	[I/U 001 O/U 01▲] ⇔[I/U 002 O/U 01 \blacklozenge] ⇔[I/U 003 O/U 01 \blacklozenge] ⇔ . . . ⇔[I/U 016 O/U 01▼]
	⑤ Then the address No. of the indoor unit to be changed is determined and the screen switches to the display " \blacklozenge SET I/U ADD."	[\blacklozenge SET I/U ADD.] (1sec.) →[I/U 001 \blacklozenge] (Blink)
3 Setting a new indoor unit No.	⑥ Set a new indoor unit No. with the \blacklozenge switch. A number indicated on the display will increase or decrease by 1 upon pressing the ▲ or ▼ switch respectively.	[I/U 000▲] ⇔[I/U 001 \blacklozenge] ⇔[I/U 002 \blacklozenge] ⇔ . . . ⇔[I/U 127▼]
	⑦ After selecting an address, press the Set switch. Then the address No. of the indoor unit is determined.	[I/U 002] (2sec.)
4 Setting a new outdoor unit No.	⑧ The display will indicate the determined indoor address No. for 2 seconds and then switch to the " \blacklozenge SET O/U ADD." screen. A default value shown on the display is the current address.	[I/U 002] (2sec lighting) ⇔[\blacklozenge SET O/U ADD.] (1sec.) ⇔[O/U 01 \blacklozenge] (Blink)
	⑨ Set a new outdoor unit No. with the \blacklozenge switch. A number indicated on the display will increase or decrease by 1 upon pressing the ▲ or ▼ switch respectively.	[O/U 00▲] ⇔[O/U 01 \blacklozenge] ⇔[O/U 02 \blacklozenge] ⇔ . . . ⇔[O/U 31▼]
	⑩ After selecting an address, press the Set switch. Then the address of the indoor unit and outdoor unit are determined.	[I/U 002 O/U 02] (2sec. lighting) →[\blacklozenge SELECT] (1sec. lighting) →[I/U SELECTION▼] (lighting)
	⑪ If you want to continue to change addresses, return to step ④.	[Press the \blacklozenge switch] (1sec.) →[SET COMPLETE] (2-10sec. lighting)
5 Ending the session	⑫ If you want to end the session (and reflect new address settings) In Step ⑩, press the ▼ switch to select "END ▲." If you have finished changing addresses, press the Set switch while "END ▲" is shown. While new settings are being transmitted, "SET COMPLETE" will be indicated. Then the remote control display will change to the normal state.	[END▲] →[SET COMPLETE] (2-10sec. lighting) →Normal state
	⑬ If you want to end the session (without reflecting new address settings) Before you complete the present address setting session, press the "ON/OFF" switch. Then the display is change to exit from this mode and switch the display to the normal state. All address settings changed in the session will be aborted and not reflected.	[ON/OFF] →Forced termination

The \blacklozenge switch will continuously change the display indication to the next one in every 0.25 seconds when it is pressed for 0.75 seconds or longer.
If the Reset switch is pressed during an operation, the display indication returns to the one that was shown before the last Set switch operation.
Even if an indoor unit No. is changed in this mode, the registered indoor unit No. before address change mode is displayed when [I/U SELECTION▼] is shown.
When "SET COMPLETE" is shown, indoor unit No.'s are registered.

NOTICE Turn on power to central control equipment after the addresses are determined.
Turning on power in wrong order may result in a failure to recognize addresses.

● 7-segment display indication in automatic address setting

Items that are to be set by the customer

Code	Contents of a display
P30	Communication protocol 0: Previous SL mode 1: New SL mode (The communication protocol is displayed ; display only)
P31	Automatic address start
P32	Input starting address Specify a starting indoor unit address in automatic address setting.
P33	Input number of connected indoor units Specify the number of indoor units connected in the refrigerant system in automatic address setting.
P34	Polarity definition 0: Network polarity not defined. 1: Network polarity defined.

7-segment display indication in automatic address setting

Code	Contents of a display
AUX	During automatic address setting X: The number of indoor units recognized by the outdoor unit
AUE	Indoor unit address setting is completed normally.
End	Polarity is defined. (Automatic address) Completed normally.

Address setting failure indication

Code	Contents of a display	Please check
A00	Unable to find any indoor unit that can be actually communicated with.	Are signal lines connected properly without any loose connections? Is power for indoor units all turned on?
A01	The number of the indoor units that can be actually communicated with is less than the number specified in P33 on the 7-segment display panel.	Are signal lines connected properly without any loose connections? Input the number of connected indoor units again.
A02	The number of the indoor units that can be actually communicated with is more than the number specified in P33 on the 7-segment display panel.	Are signal lines connected properly without any loose connections? Are the network connectors coupled properly? Input the number of connected indoor units again.
A03	Starting address (P32) + Number of connected indoor units (P33) > 128	Input the starting address again. Input the number of connected indoor units again.
A04	While some units are operating in the previous SL mode on the network, the automatic address setting on multiple refrigerant systems is attempted.	Perform manual address setting. Separate old SL setting unit from the network Arrange all units to operate in the new SL.

Error indication

Code	Contents of a display	Cause
E2	Duplicating indoor unit address	• Incorrect manual address setting
E3	Incorrect pairing of indoor-outdoor units	• An outdoor unit number that does not exist in the network is specified • No master unit exists in combination outdoor unit.
E11	Address setting for plural remote controls	• Indoor unit address is set from plural remote controls.
E12	Incorrect address setting of indoor units	• Automatic address setting and manual address setting are mixed.
E31	Duplicating outdoor unit address	• Plural outdoor units are exist as same address in same network.
E46	Incorrect setting	• Automatic address setting and manual address setting are mixed.

7-2. Selection switching

Controls of outdoor unit may be selected as follows using the DIP switches on the PCB and P○○ on the 7-segment.

To change P○○ on the 7-segment, hold down SW8 (increasing a number shown on the 7-segment display panel: one's place), SW9 (increasing a number shown on the 7-segment display panel: tens place) and SW7 (Data write/Enter).

Control selecting method		P○○ on 7-segment	Content of control
SW setting on PCB		Set external input function allocation to "2" *1	Forced cooling mode (It can be fixed at cooling with external input terminals open, or at heating with them short-circuited.)
SW3-7 to ON=1 *1		—	Cooling test run
SW5-1 to ON + SW5-2 to ON		—	Heating test run
SW5-1 to ON + SW5-2 to OFF		—	Pump down operation
Close the fluid operation valve on outdoor unit and set as follows: (1) SW5-2 on PCB to ON (2) SW5-3 on PCB to ON (3) SW5-1 on PCB to ON		—	Set allocation of external input function to "1" *1
SW4-5:OFF, SW4-6:OFF*1		80% (Factory default)	Inputting signals to external input terminals selects the demand mode. (J13 short-circuited: Level input, J13 open: Pulse input)
SW4-5:ON, SW4-6:OFF*1		60%	
SW4-5:OFF, SW4-6:ON*1		40%	
SW4-5:ON, SW4-6:ON*1		00%	
SW5-5		—	Communication method selection ON: Previous SL communication, OFF: New SL communication
J13: Closed (Factory default), J13: Open		—	External input switing (CnS1, CnS2 only) Closed: Level input, Open: Pulse input
J14: Closed (Factory default), J14: Open		—	Defrost recover temperature Closed: normal, Open: cold weather district
J15: Closed (Factory default), J15: Open		—	Defrost start temperature Closed: normal, Open: cold weather district
—		P01	Operation priority selection 0: First push priority (at shipping) 1: Last push priority 2: Priority of master unit's setting operation mode 3: Priority of required major operation mode
—		P02	Outdoor unit fan snow protection control 0: Control disabled (at shipping) 1: Control enabled
—		P03	Outdoor unit fan snow protection control ON time setting - 30 sec (at shipping) 10, 30-600 sec
—		P04	Energy saving mode *2 OFF: Disabled (at shipping) 2 stage demand mode 000, 040, 060, 080 [%]
—		P05	Silencing mode setting 0 (at shipping) - 3: Larger values for larger effect
—		P06	Allocation of external output (CnZ1)
—		P07	Allocation of external input (CnS1)
—		P08	Allocation of external input (CnS2)
—		P09	Allocation of external input (CnG1)
—		P10	Allocation of external input (CnG2)
—		P11~	Spare

*1 Control is switched when both the allocation of external input function (P07-10) and switches are changed.

(Example: To use CnS1 for the input of forced cooling mode, set P07 at 2 and SW3-7 at ON. To use CnS2 for the input of forced cooling mode, set P08 at 2 and SW3-7 at ON.)

*2 In the energy saving mode, the capacity restriction becomes effective even if no signals are input at external input terminals.

By changing the allocation of external input functions (P07-19) on the 7-segment, functions of external input terminals may be selected. Inputting signals to external input terminals enable the following functions.

Setting value for allocation of external input function	With external input terminals closed	With external input terminals open
"0" : External operation input	Invalid	Valid
"1" : Demand input	Invalid	Valid
"2" : Cooling/heating forced input	Valid	Invalid
"3" : Silent mode 1 *1	Valid	Invalid
"4" : Spare		
"5" : Outdoor fan snow guard control input	Valid	Invalid
"6" : Test run external input 1 (equivalent to SW5-1)	Test run start	Normal
"7" : Test run external input 2 (equivalent to SW5-2)	Cooling	Heating
"8" : Silent mode 2 *2	Valid	Invalid
"9" : 2 stage demand input	Invalid	Valid

*1 Valid/invalid is changed depending on outdoor temperature.

*2 It is always Valid, regardless of outdoor temperature.

The external output function of CnZ1 can be changed by changing the setting in P06 on the 7-segment display panel.

"0" : Operation output
"1" : Error output
"2" : Compressor ON output
"3" : Fan ON output
"4 - 9" : Spare

7-3. External input and output terminals specifications

Name	Purpose (Factory default)	Specification	Operating side connector
External input CnS1	External operation input (Closed at shipping)	Non-voltage contactor (DC12V)	J.S.T (NICHIAITSU) B02B-XAMK-1 (LF) (SN)
External input CnS2	Demand input (Closed at shipping)	Non-voltage contactor (DC12V)	J.S.T (NICHIAITSU) B02B-XARK-1 (LF) (SN)
External input CnG1	Cooling/Heating forced input (Open at shipping)	Non-voltage contactor (DC12V)	J.S.T (NICHIAITSU) B02B-XAEK-1 (LF) (SN)
External input CnG2	Silencing mode input (Open at shipping)	Non-voltage contactor (DC12V)	J.S.T (NICHIAITSU) B02B-XASK-1 (LF) (SN)
External output CnZ1	Spare output (External output)	DC12V output	MOLEX 5566-02A-RE
External output CnH	Operation output	DC12V output	MOLEX 5566-02A-BU
External output CnY	Error output	DC12V output	MOLEX 5266-02A

8. TEST OPERATION AND TRANSFER

8-1. Before starting operation

- (1) **Make sure that a measurement between the power source terminal block and ground, when measured with a 500V megger tester, is greater than 1 MΩ.**
- (2) When the resistance of the signaling line terminal block is 100Ω or less before turning the power on, the power cables may be connected to the signaling line terminal block. Check the wiring referring to the standard resistance value of 6-3.
- (3) **Be sure turn ON the power source to supply power to the crank case heater 6 hours before operation.**
After supplying the power to the crank case heater, the compressor may not start unless the time mentioned above elapses. (For protection of compressor)
In such occasion, the 7-segment LED shows "dL○○○○". Wait till the temperature in the compressor rises sufficiently after turning power on to the crank case heater, before starting the test run.
- (4) **Make sure that the bottom of the compressor casing is warm.**
- (5) Be sure to fully open the service valves (liquid, gas) for the outdoor unit.
Operating the outdoor unit with the valves closed may damage the compressor.
- (6) **Confirm that the power is supplied to all indoor units. It could cause trouble if there is any indoor unit which is not powered.**

CAUTION

Please make sure that the service valves (gas, liquid) are full open before a test run. Conducting a test run with any of them in a closed position can result in a compressor failure.

8-2. Test run

(1) Test run from an outdoor unit.

Whether CnS1 is set to ON or OFF, you can start a test run by using the SW5-1 and SW5-2 switches provided on the outdoor unit PCB.

Select the test run mode first.

Please set SW5-2 to ON for a cooling test run or OFF for a heating test run. (It is set to OFF at the factory for shipment.)

Turning SW5-1 from OFF to ON next will cause all connected indoor units to start.

When a test run is completed, please set SW5-1 to OFF.

Note: During a test run, an indoor unit cannot be operated from the remote control unit (to change settings). ("Under central control" is indicated.)

(2) Method of starting a test run for a cooling operation from an outdoor unit: please operate a remote control unit according to the following steps.

(a) Start of a cooling test run

○ Operate the unit by pressing the **[START/STOP]** button.

○ Select the "COOLING" mode with the **[MODE]** button.

○ Press the **[TEST RUN]** button for 3 seconds or longer.

The screen display will be switched from "Select with ITEM **◆**" → "Determine with **[SET]**" → "Cooling test run **▼**."

○ When the **[SET]** button is pressed while "Cooling test run **▼**" is displayed, a cooling test run will start. The screen display will be switched to "COOLING TEST RUN."

(b) Termination of a cooling test run

○ When the **[START/STOP]** button or the "TEMP SET **☑** **☒**" button is pressed, a cooling test run will be terminated.

8-3. Transfer

- After completing the installation and test run, explain methods of use and maintenance to the customer, referring to the Instruction Manual. Ask the customer to keep the installation manual safely together with the Instruction Manual.
- Instruct the customer that the power should not be turned off even if the unit is not to be used for a long time. This will enable operation of the air-conditioner any time. (Since the compressor bottom is warmed by the crank case heater, seasonal compressor trouble can be prevented.)

9. CAUTIONS FOR SERVICING (for R410A and compatible machines)

- (1) To avoid mixing of different types of oil, use separate tools for each type of refrigerant.
- (2) To avoid moisture from being absorbed by the ice machine oil, the time for when the refrigerant circuit is open should be kept as short as possible. (Within 10 min. is ideal.)
- (3) For other piping work, airtightness testing, vacuuming, and refrigerant charging, refer to section 4, REFRIGERANT PIPING.
- (4) Diagnostic Inspection Procedures
For the meanings of failure diagnosis messages, please refer to the technical manual.
- (5) 7-segment LED indication
Data are indicated when so chosen with the indication selector switch. For the details of indication, please refer to the technical manual.
- (6) Internal wiring
After maintenance, all wiring, wiring ties and the like, should be returned to their original state and wiring route, and the necessary clearance from all metal parts should be secured.

6.2 Check operation procedure

PCB012D027A

Check operation

It is recommended to practice the check operation before the test run.
(You may test run or perform normal operation even if the check operation is not performed.)
For details of check operation, refer to the technical manual.

Important:

- Before starting the check operation, complete the address setting of indoor and outdoor units and the refrigerant charge.
- You cannot check precisely unless proper quantity of refrigerant is charged.
- You cannot perform the check operation when the system is stopped under abnormal condition.
- You cannot perform the check operation when total capacity of connected indoor units is less than 80% of outdoor units.
- You cannot perform the check operation if the communication protocol is the conventional Superlink (previous SL).
- Don't perform the check operation at the same time on a plural number of refrigerant systems. You cannot check precisely.
- Perform the check operation within the applicable temperature range (Outdoor air temperature: 0 - 43°C, indoor air temperature: 10 - 32°C). You cannot start the check operation if it is out of the applicable temperature range.
- You cannot check the fresh air ventilation indoor unit and the outdoor air processing unit. (You can check indoor units other than the fresh air ventilation indoor unit and the outdoor air processing unit on the same refrigerant system.)
- You cannot perform the check operation if the connected indoor unit is only one in one refrigerant system.
- You cannot perform the check operation if it is set at 0% in the demand mode or capacity save mode.
- Turn on the crankcase heater 6 hours before the check operation.
(If the degree of overheat at the under-dome is lower than 15°C, the check operation may not start because of the protective control.)

(1) Check item

Check operation allows confirming the following points.

- Whether the service valve is closed or not (Open/close check)
- Whether refrigerant pipes and signal line are connected properly on indoor/outdoor units or not (Mismatch check)
- Whether the indoor unit expansion valve operates properly or not (Expansion valve failure check)

(2) Procedure of check operation

(a) Start of check operation

- Confirm that all of SW3-7 (Forced cooling/heating mode), SW5-1 (Test run), SW5-2 (Test run cooling setting) and SW5-3 (Pump-down operation) are turned OFF.
- Change then SW3-5 (Check operation) OFF→ON to start the check operation.
- It takes normally about 15 - 30 minutes from the start to the end of check operation. (Max. 80 minutes)

(b) Termination of check operation and result display

- As the check operation terminates, the system stops automatically and displays the result on the 7-segment indicator.

<Normal termination>

- "CHO End" is shown on the 7-segment indicator.
- Return SW3-5 to OFF setting. 7-segment indicator returns to normal display.

<Termination by error>

- Error is displayed on the 7-segment indicator.
- Correct the abnormal condition referring to the "Check Point" column, and return SW3-5 to OFF.
- Restart then the check operation from (2) (a).

7-segment display during check operation

Code	Data	Content
H1	Max. remaining time	• Preparing for check operation. Indicates the maximum remaining time (minute).
H2	Max. remaining time	• During the check operation. Indicates the maximum remaining time (minute).
CHO	End	• Normal termination of check operation.

Display on 7-segment indicator after check operation

Code	Data	Content	Check Point
CHL	---	Service valve is closed. (Refrigerant circuit is choked somewhere.)	<ul style="list-style-type: none"> • Is the service valve of outdoor unit closed? • Is the low pressure sensor normal? (Detection pressure can be confirmed on 7-segment indicator.) • Is the coil connector of indoor unit expansion valve connected? • Is the expansion valve coil of indoor unit detached from the valve body? • Is the heat exchanger sensor of indoor unit normal? (Check for sensor disconnection.)
CHU	Abnormal indoor unit No.	Mismatch of refrigerant pipes/signal line. Refrigerant is not circulated in the abnormal indoor unit.	<ul style="list-style-type: none"> • Are refrigerant pipes/signal line connected properly between indoor and outdoor units? • Is the coil connector of indoor unit expansion valve connected? • Is the expansion valve coil of indoor unit detached from the valve body? • Is the heat exchanger sensor of indoor unit normal? (Check for sensor disconnection.)
CHJ	Abnormal indoor unit No.	Expansion valve does not operate properly on the abnormal indoor unit.	<ul style="list-style-type: none"> • Is the coil connector of indoor unit expansion valve connected? • Is the expansion valve coil of indoor unit detached from the valve body? • Is the heat exchanger sensor of indoor unit normal? (Check for sensor disconnection.)
CHE	---	Termination of check operation by error	<ul style="list-style-type: none"> • Is any error (E??) indicated on indoor or outdoor units? • Is signal line connected without loose? • Was any SW setting changed during check operation?
CHE	Abnormal indoor unit No.	Termination of check operation by error. Indicated indoor unit is under abnormal condition.	<ul style="list-style-type: none"> • Is any error (E??) indicated on indoor or outdoor units? • Is signal line connected without loose? • Is the power supply turned ON at the indoor unit side?

*Errors other than the above may be indicated by the detection of error. In such occasion, correct the matter by referring to the technical manual.

*Code and Data are indicated alternately by 4-second intervals.

6.3 Method for connecting the accessory pipe

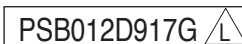

Be sure to use the accessory pipe to connect the operation valve on the gas side with the field pipe.

- * Connect the attached pipe according to the following steps ① - ⑤. When tightening the flare, connect the pipe securely by pressing the flared face of pipe against the operation valve. When brazing between the pipe in place and the attached pipe, confirm that no excessive force is applied to the flare joint. Otherwise gas could leak from the flare joint.
- ① Referring to Table ① and Table ②, prepare the straight pipe and the elbow in the field, which are used in the construction examples A-D applicable to the connecting direction.
- ② Firstly, use the accessory pipe to assemble the connecting pipe assembly outside the outdoor unit. As shown in the figures of construction examples (A)~(D) applicable to the connecting direction (chain double dashed line), braze the accessory pipe and the parts prepared in the above ①.
 - Orient the accessory pipe according to the dimensions as shown in □ of Fig. 1.
- ③ After assembly of the connecting pipe, connect it to the service valve on the gas side inside the outdoor unit. Tighten the flare nut with appropriate torque.
- ④ After connection of the connecting pipe assembly to the service valve on the gas side, braze the connecting pipe assembly and the field pipe.
- ⑤ After the brazing, insulate using the attached heat insulating material and band as shown by Fig. 2.

Table ① Parts used for the connecting pipe assembly

No.	Name	Quantity	Remark
1	Accessory pipe	1	Accessory
2	Heat insulating material	1	Accessory
3	Band	2	Accessory
4	Straight pipe ①	1	Procured at the field
5	Straight pipe ②	1 or 0	Procured at the field (Not required for downward direction)
6	Elbow	1 or 0	Procured at the field (Not required for downward direction)

Table ② Length and specification of straight pipe (Procured in the field)

	Ⓐ Downward	Ⓑ Forward	Ⓒ Rightward	Ⓓ Backward
Straight pipe ①	270mm or over	70-120mm	70-120mm	70-120mm
Straight pipe ②	—	125mm or over	125mm or over	515mm or over

- Be sure to use pipes of 1/2H material, and wall thickness above 1mm. (Pressure resistance of O-type pipe is not enough)

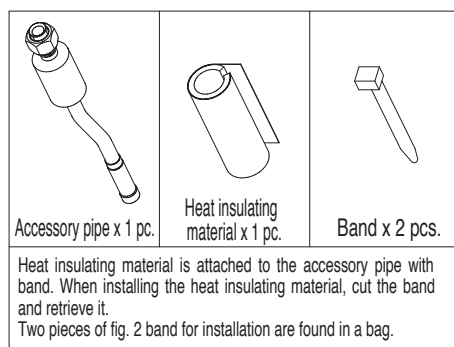

Pipe specification	
224	φ 19.05 × T1.0
280	φ 22.22 × T1.0
335	φ 25.4 × T1.0

- Select and use the pipes, which are procured in the field, according to the specification that corresponds to the outdoor unit capacity as described in the installation manual.

About brazing

Be sure to braze while supplying nitrogen gas.

- If no nitrogen gas is supplied, a large amount of impurity (oxidized film) will be generated, which may clog the capillary tube and the expansion valve, resulting in fatal malfunction.

Proper torque	
φ 19.05	100-120N·m

【Connection example (A)~(D) applicable to the connecting direction.】

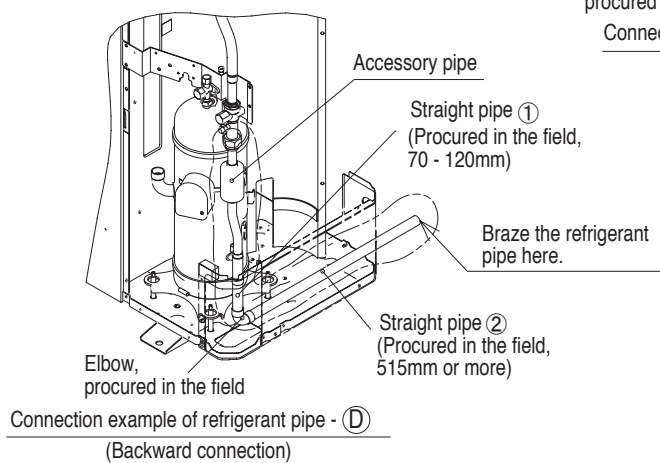
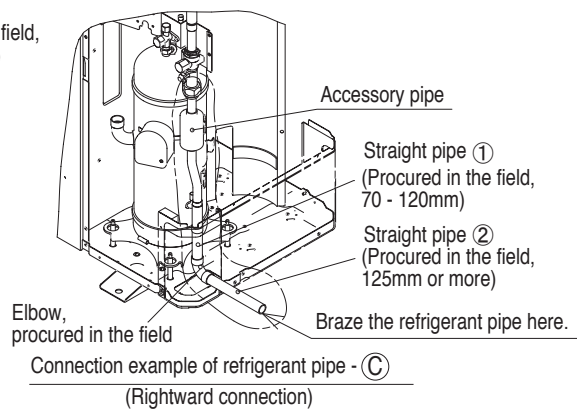
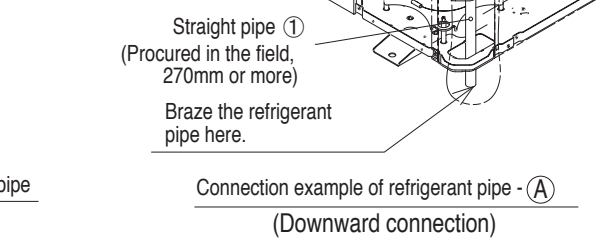
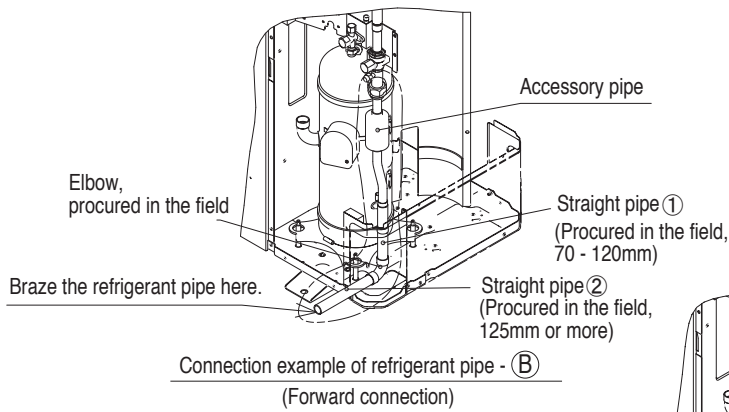
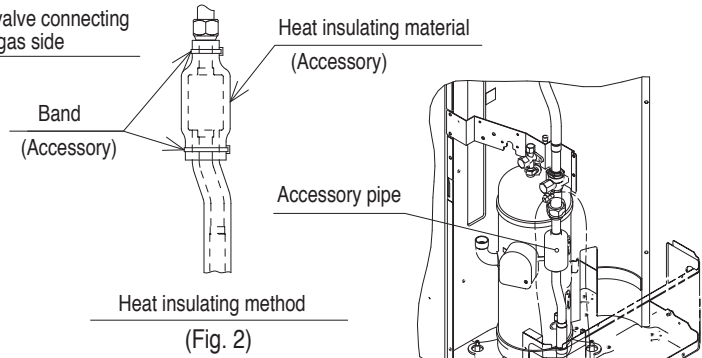
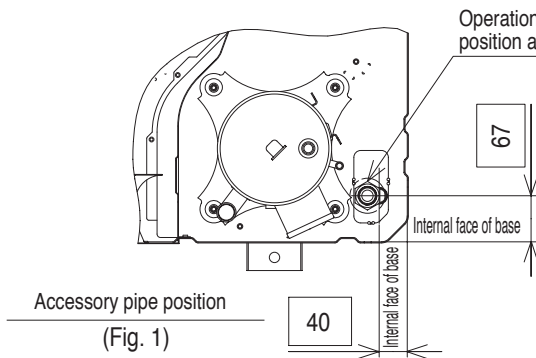

6.4 Instructions for installing the branch pipe set

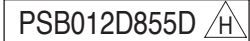

- ⊙ This manual describes the specifications of branching pipe set and header set installation. For outdoor unit installation and indoor unit installation, please refer to the respective installation manuals supplied with your outdoor unit and indoor unit.
- ⊙ Before you set about installation work, please read this manual carefully so that you can carry out installation work according to the instructions contained herein.
- Please read the safety instructions contained in the installation manual supplied with your outdoor unit carefully and carry out installation work unerringly.
- When installation work is completed, conduct a test run to check the installation for any anomaly. Please also give the customer necessary instructions as to the operation and maintenance of the unit pursuant to the instruction manual (supplied with the indoor unit).
- Please ask the customer to keep the installation manual on the customer's part together with the instruction manual.

PARTS LIST

Branching pipe set type	Gas side	Liquid side	Different diameter pipe joint
Branching pipe set	DIS-22-1G 		None
	DIS-180-1G 		
	DIS-371-1G 		
	DIS-540-3 		
Outdoor unit's branching pipe set	DOS-2A-3 		
	DOS-3A-3 Branch pipe 1 	Branch pipe 1 	
	Branch pipe 2 	Branch pipe 2 	

Branching pipe set type	Gas side	Liquid side	Different diameter pipe joint
HEAD4-22-1G			None
HEAD6-180-1G			
HEAD8-371-2			
HEAD8-540-3			

INSTALLATION PROCEDURE

(1) Please select an appropriate branching pipe set model and a pipe size by consulting with the installation manual of the indoor unit or other relevant technical documents.

Attention

- Use a pipe conforming to a pipe size specified for indoor unit connection for the section between an indoor unit and a branching pipe.
- Use a pipe conforming to a pipe size specified for outdoor unit connection for the section between an outdoor branching pipe and an outdoor unit.

(2) Cut a branching pipe set or a different diameter joint with a pipe cutter to make it fit for a selected pipe size before application.

Attention

- In cutting pipes, always use a pipe cutter. Remove burrs from a cut end when you cut a pipe. In doing so, keep a cut end downward so that no chips or burrs may enter the pipe.
- Take utmost care so that no foreign matter such as dust or water may enter piping during installation work.
 - Please cover all the open ends of piping until installation work is completed. Particularly, any openings in the section of piping laid outdoors should be sealed stringently.
 - As long as possible, avoid open ends left facing upward. Make them face either horizontally or downward.
- A branching joint (for both gas and liquid) must always be positioned in such a way that it branches either horizontally or vertically.

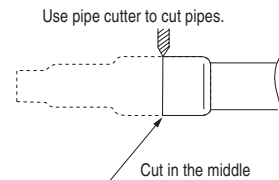

• In the case of a branching pipe set (model type DIS)

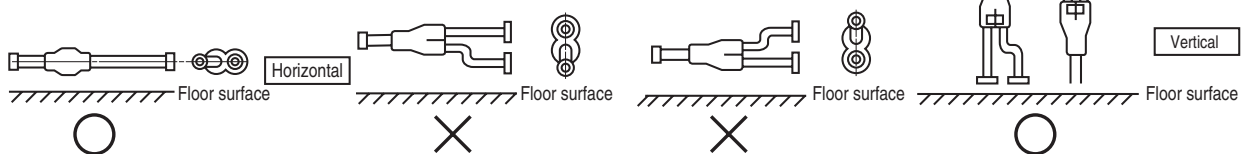

• In the case of an outdoor unit's branching pipe set (model type DOS)

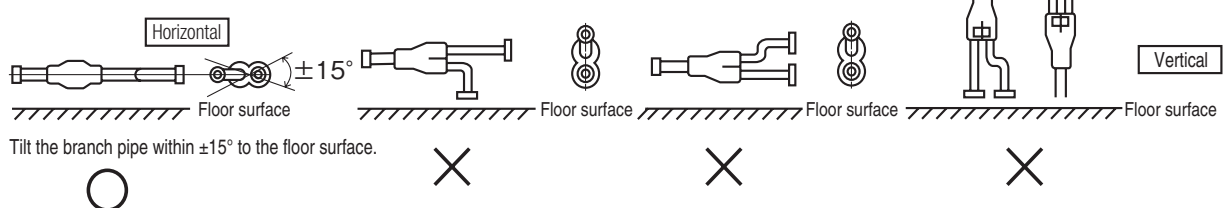

• In the case of a header set (model type HEAD)

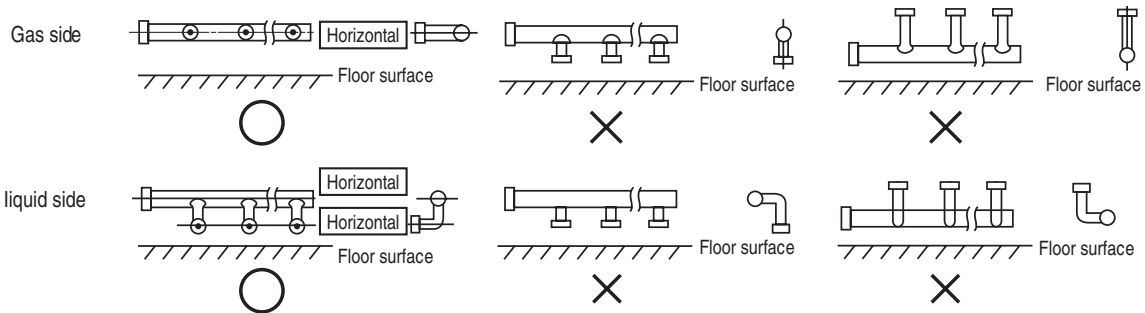

④ When using the outdoor unit's branch pipe set, make sure to secure a straight section of 500mm or more for both the gas and liquid pipes before branching them.

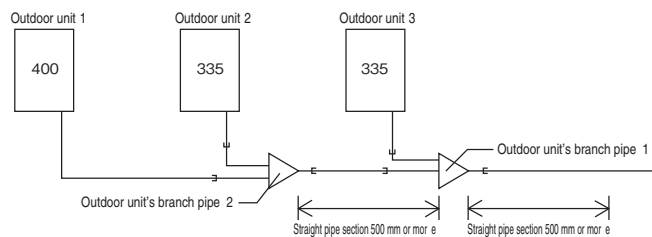

⑤ Always apply nitrogen gas when soldering joints. If nitrogen gas is not applied, a large amount of film oxide will be formed which could lead to a critical failure in the unit. Use caution to prevent moisture or any foreign matters from entering the pipe when connecting pipe ends.

For the method of air tightness testing and pulling air, please refer to the installation manual of the outdoor unit.

⑥ Do not leave piping with any open ends uncovered to prevent water or foreign matters from entering inside.

(3) Please dress it with an attached insulation sheet for heat insulation. (Please dress both liquid and gas sides.)

Attention

- ① Apply an attached insulation sheet along a pipe, tape the joining line with a joint tape (to be procured on the installer's part) for complete sealing, and wrap the pipe and insulation sheet entirely with a tape.
- ② Dress both liquid and gas pipes with attached insulation sheets for heat insulation.
- ③ Ensure that the liquid pipe is given the heat insulation as good as that of the gas pipe. The absence of heat insulation can cause dripping water from dew condensing on the pipe or performance degradation.

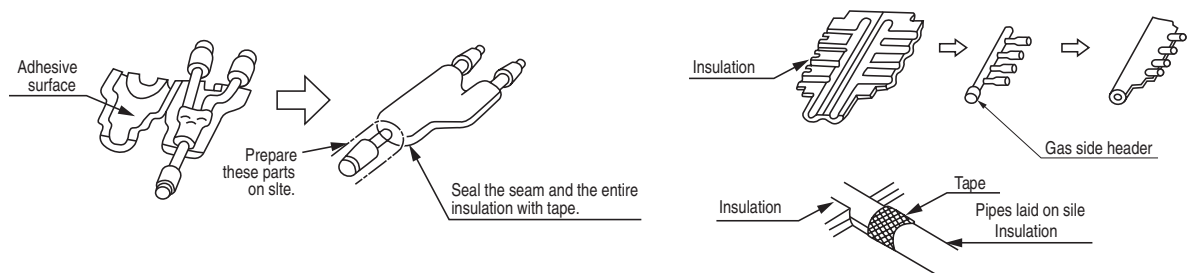

(4) How to select a branching pipe

1) Method to select a branch pipe set (Type DIS)

- An appropriate branching pipe size varies depending on the capacity of connected indoor units (combined total capacity connected downstream), so please choose from the table below.
- In the case of a 140/160 (5/6HP) outdoor unit, however, select DIS-22-1G. (Even if the capacity of connected indoor units reaches 180 or higher, select DIS-22-1G.)

Total capacity downstream	Branching pipe set model type
less than 180	DIS-22-1G
180 or higher – less than 371	DIS-180-1G
371 or higher – less than 540	DIS-371-1G
540 or more	DIS-540-3

Attention

- ① Use a pipe conforming to a pipe size specified for indoor unit connection for the section between an indoor unit and an indoor unit side branching pipe.
- ② A branching joint (for both gas and liquid) must always be positioned in such a way that it branches either horizontally or vertically.

2) How to select a header set

- Depending on the number of units connected, connect plugged pipes (to be procured on the installer's part) at a branching point (on the indoor unit connection side).
- For the size of a plugged pipe, please refer to the documentation for a header set (optional part).
- In the case of a 140/160 (5/6HP) outdoor unit, however, select HEAD4-22-1G. (Even if the capacity of connected indoor units reaches 180 or higher, select HEAD4-22-1G.)

Total capacity downstream	Header set model type	Number of branches
less than 180	HEAD4-22-1G	Up to 4 branches
180 or higher – less than 371	HEAD6-180-1G	Up to 6 branches
371 or higher – less than 540	HEAD8-371-2	Up to 8 branches
540 or more	HEAD8-540-3	Up to 8 branches

Attention

- ① Use a pipe conforming to a pipe size specified for indoor unit connection for the section between a header and an indoor unit.
- ② Always position a header (both gas and liquid headers) in such a way that it branches horizontally.
- ③ No 224 or 280 indoor unit is connectable to a header.

(5) Example of piping

Example 1: Branching type configuration

Connected capacity: 294

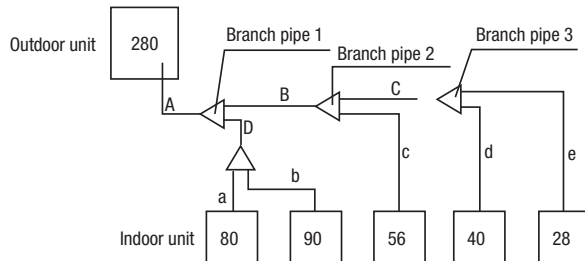

Selection of a branching pipe set

Mark	Selection procedure	Branching pipe set
Branch pipe 1	Combined total capacity of indoor units connected downstream (80+90+56+40+28)=294	DIS-180-1G
Branch pipe 2	Combined total capacity of indoor units connected downstream (56+40+28)=124	DIS-22-1G
Branch pipe 3	Combined total capacity of indoor units connected downstream (40+28)=68	DIS-22-1G

Example 2: Header type configuration

Connected capacity: 272

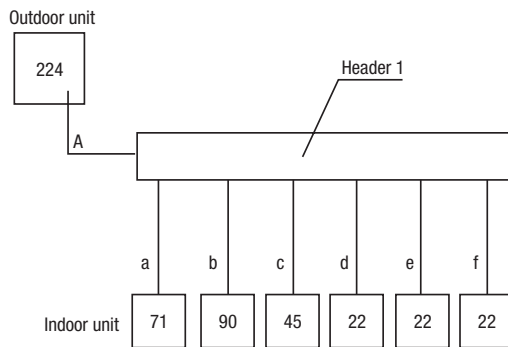

Selection of a header set

Mark	Selection procedure	Header set
Header 1	Combined total capacity of indoor units connected downstream (71+90+45+22+22+22)=272	HEAD6-180-1G

Example 3: Branching + Header mixed type configuration

Connected capacity: 1394

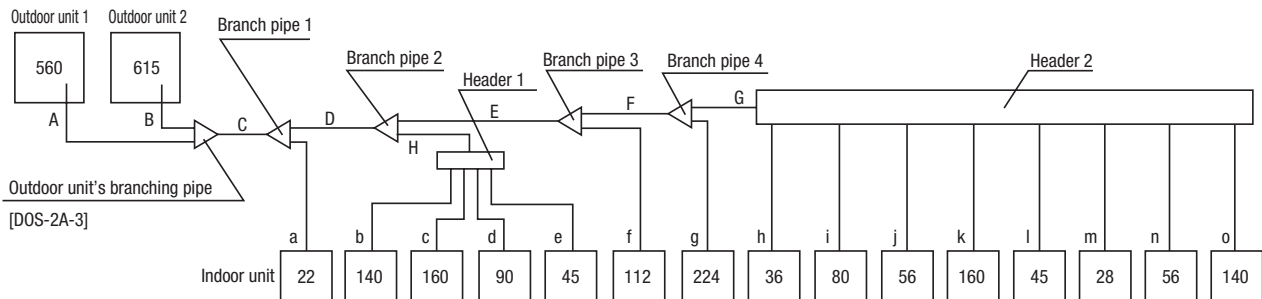

Selection of a branching pipe set

Mark	Selection procedure	Branching pipe set
Branch pipe 1	Combined total capacity of indoor units connected downstream (22+140+160+90+45+112+224+36+80+56+160+45+28+56+140)=1394	DIS-540-3
Branch pipe 2	Combined total capacity of indoor units connected downstream (140+160+90+45+112+224+36+80+56+160+45+28+56+140)=1372	DIS-540-3
Branch pipe 3	Combined total capacity of indoor units connected downstream (112+224+36+80+56+160+45+28+56+140)=937	DIS-540-3
Branch pipe 4	Combined total capacity of indoor units connected downstream (224+36+80+56+160+45+28+56+140)=825	DIS-540-3

Selection of a header set

Mark	Selection procedure	Header set
Header 1	Combined total capacity of indoor units connected downstream (140+160+90+45)=435	HEAD8-371-2
Header 2	Combined total capacity of indoor units connected downstream (36+80+56+160+45+28+56+140)=601	HEAD8-540-3

7. TECHNICAL INFORMATION

PSA012J130A

7.1 Outdoor units

Model(s) : FDC224KXZME1							
Outdoor side heat exchanger of air-conditioner : air							
Indoor side heat exchanger of air-conditioner : air							
Type : vapour compression							
if applicable : electric motor							
Item	Symbol	Value	Unit	Item	Symbol	Value	Unit
Rated cooling capacity	Prated,c	22.4	kW	Seasonal space cooling energy efficiency	ηs,c	258.9	%
Declared cooling capacity for part load at given outdoor temperatures Tj and indoor 27°C/19°C(dry/wet bulb)				Declared energy efficiency ratio or gas utilization efficiency / auxiliary energy factor for part load at given outdoor temperatures Tj			
Tj=+35°C	Pdc	22.4	kW	Tj=+35°C	EERd or GUEc,bin / AEFc,bin	400.0	%
Tj=+30°C	Pdc	16.5	kW	Tj=+30°C	EERd or GUEc,bin / AEFc,bin	555.0	%
Tj=+25°C	Pdc	10.6	kW	Tj=+25°C	EERd or GUEc,bin / AEFc,bin	845.0	%
Tj=+20°C	Pdc	8.6	kW	Tj=+20°C	EERd or GUEc,bin / AEFc,bin	954.0	%
Degradation coefficient for air conditioners**	Cdc	0.25	-				
Power consumption in other than 'active mode'							
Off mode	P _{OFF}	0.043	kW	Crankcase heater mode	P _{CK}	0.043	kW
Thermostat-off mode	P _{TO}	0.000	kW	Standby mode	P _{SB}	0.043	kW
Other items				For air-to-air air-conditioner: air flow-rate,outdoor measured			
Capacity control		variable				12000	m ³ /h
Sound power level, outdoor	L _{WA}	73.0	dB				
If engine driven: Emissions of nitrogen oxides	NOx ***	-	mg/kWh fuel input GCV				
GWP of the refrigerant		2088	kg CO _{2eq} (100years)				
Contact details	Mitsubishi heavy industries thermal systems,LTD						
** If Cdc is not determined by measurement then the default degradation coefficient air-conditioners shall be 0,25.							
*** from 26 September 2018							
Where information relates to multi-split air-conditioners,the test result and performance data be obtained on the basis of the performance of the outdoor unit, with a combination of indoor unit(s) recommended by the manufacturer or importer.							

Information to identify the model(s) to which the information relates :				FDC224KXZME1			
Outdoor side heat exchanger of heat pump :				air			
Indoor side heat exchanger of heat pump :				air			
Indication if the heater is equipped with a supplementary heater :				No			
if applicable :				electric motor			
Parameters shall be declared for the average heating season , parameters for the warmer and colder heating seasons are optional.							
Item	Symbol	Value	Unit	Item	Symbol	Value	Unit
Rated heating capacity	Prated,h	22.4	kW	Seasonal space heating energy efficiency	ηs,h	178.9	%
Declared heating capacity for part load at indoor temperature 20°C and outdoor temperature Tj				Declared coefficient of performance or gas utilization efficiency / auxiliary energy factor for part load at given outdoor temperatures Tj			
Tj=-7°C	Pdh	17.4	kW	Tj=-7°C	COPd or GUEh,bin / AEFh,bin	328.0	%
Tj=+2°C	Pdh	10.6	kW	Tj=+2°C	COPd or GUEh,bin / AEFh,bin	436.0	%
Tj=+7°C	Pdh	6.8	kW	Tj=+7°C	COPd or GUEh,bin / AEFh,bin	587.0	%
Tj=+12°C	Pdh	5.6	kW	Tj=+12°C	COPd or GUEh,bin / AEFh,bin	632.0	%
Tbiv=bivalent temperature	Pdh	19.7	kW	Tbiv=bivalent temperature	COPd or GUEh,bin / AEFh,bin	292.0	%
TOL=operation limit	Pdh	14.9	kW	TOL=operation limit	COPd or GUEh,bin / AEFh,bin	238.0	%
For air-to-water heat pumps : Tj=-15°C (if TOL < -20°C)	Pdh	-	kW	For air-to-water heat pumps: Tj=-15°C (if TOL < -20°C)	COPd or GUEh,bin / AEFh,bin	-	%
Bivalent temperature	Tbiv	-10.0	°C	For water-to-air heat pumps: Operation limit Ta,temperature		-	°C
Degradation coefficient heat pumps**	Cdh	0.25	-				
Power consumption in modes other than 'active mode'				Supplementary heater back-up heating capacity			
Off mode	P _{OFF}	0.043	kW		elbu	-	kW
Thermostat-off mode	P _{TO}	0.043	kW	Type of energy input	P _{SB}	0.043	kW
Crankcase heater mode	P _{CK}	0.043	kW	Standby mode			
Other items				For air-to-air heat pumps: air flow-rate,outdoor measured			
Capacity control		variable				12000	m ³ /h
Sound power level, outdoor measured	L _{WA}	75.0	dB	For water-/brine-to-air heat pumps : Rated brine or water flow-rate, outdoor side heat exchanger		-	m ³ /h
Emissions of nitrogen oxides(if applicable)	NOx ***	-	mg/kWh fuel input GCV				
GWP of the refrigerant		2088	kg CO _{2eq} (100years)				
Contact details				Mitsubishi heavy industries thermal systems,LTD			
** If Cdh is not determined by measurement then the default degradation coefficient air-conditioners shall be 0,25. *** from 26 September 2018 Where information relates to multi-split air-conditioners,the test result and performance data be obtained on the basis of the performance of the outdoor unit, with a combination of indoor unit(s) recommended by the manufacturer or importer.							

Model(s) : FDC280KXZME1			
Outdoor side heat exchanger of air-conditioner : air			
Indoor side heat exchanger of air-conditioner : air			
Type : vapour compression			
if applicable : electric motor			
Item	Symbol	Value	Unit
Rated cooling capacity	Prated,c	28.0	kW
Declared cooling capacity for part load at given outdoor temperatures Tj and indoor 27°C/19°C(dry/wet bulb)			
Tj=+35°C	Pdc	28.0	kW
Tj=+30°C	Pdc	20.6	kW
Tj=+25°C	Pdc	13.2	kW
Tj=+20°C	Pdc	8.6	kW
Degradation coefficient for air conditioners**	Cdc	0.25	-
Power consumption in other than 'active mode'			
Off mode	P _{OFF}	0.043	kW
Thermostat-off mode	P _{TO}	0.000	kW
Other items			
Capacity control		variable	
Sound power level, outdoor	L _{WA}	75.0	dB
If engine driven: Emissions of nitrogen oxides	NOx ^{***}	-	mg/kWh fuel input GCV
GWP of the refrigerant		2088	kg CO _{2eq} (100years)
Contact details Mitsubishi heavy industries thermal systems,LTD			
<p>** If Cdc is not determined by measurement then the default degradation coefficient air-conditioners shall be 0,25. *** from 26 September 2018 Where information relates to multi-split air-conditioners,the test result and performance data be obtained on the basis of the performance of the outdoor unit, with a combination of indoor unit(s) recommended by the manufacturer or importer.</p>			

Information to identify the model(s) to which the information relates :				FDC280KXZME1			
Outdoor side heat exchanger of heat pump :				air			
Indoor side heat exchanger of heat pump :				air			
Indication if the heater is equipped with a supplementary heater :				No			
if applicable :				electric motor			
Parameters shall be declared for the average heating season , parameters for the warmer and colder heating seasons are optional.							
Item	Symbol	Value	Unit	Item	Symbol	Value	Unit
Rated heating capacity	Prated,h	28.0	kW	Seasonal space heating energy efficiency	η_s,h	178.7	%
Declared heating capacity for part load at indoor temperature 20°C and outdoor temperature Tj				Declared coefficient of performance or gas utilization efficiency / auxiliary energy factor for part load at given outdoor temperatures Tj			
Tj=-7°C	Pdh	18.3	kW	Tj=-7°C	COPd or GUEh,bin / AEFh,bin	328.0	%
Tj=+2°C	Pdh	11.1	kW	Tj=+2°C	COPd or GUEh,bin / AEFh,bin	436.0	%
Tj=+7°C	Pdh	7.2	kW	Tj=+7°C	COPd or GUEh,bin / AEFh,bin	582.0	%
Tj=+12°C	Pdh	5.6	kW	Tj=+12°C	COPd or GUEh,bin / AEFh,bin	641.0	%
Tbiv=bivalent temperature	Pdh	20.7	kW	Tbiv=bivalent temperature	COPd or GUEh,bin / AEFh,bin	285.0	%
TOL=operation limit	Pdh	15.5	kW	TOL=operation limit	COPd or GUEh,bin / AEFh,bin	241.0	%
For air-to-water heat pumps : Tj=-15°C (if TOL < -20°C)	Pdh	-	kW	For air-to-water heat pumps: Tj=-15°C (if TOL < -20°C)	COPd or GUEh,bin / AEFh,bin	-	%
Bivalent temperature	Tbiv	-10.0	°C	For water-to-air heat pumps: Operation limit Ta temperature		-	°C
Degradation coefficient heat pumps**	Cdh	0.25	-				
Power consumption in modes other than 'active mode'				Supplementary heater back-up heating capacity			
Off mode	P _{OFF}	0.043	kW		elbu	-	kW
Thermostat-off mode	P _{TO}	0.062	kW	Type of energy input	P _{SB}	0.043	kW
Crankcase heater mode	P _{CK}	0.043	kW	Standby mode			
Other items				For air-to-air heat pumps: air flow-rate, outdoor measured			
Capacity control		variable				12000	m ³ /h
Sound power level, outdoor measured	L _{WA}	76.0	dB	For water-/brine-to-air heat pumps : Rated brine or water flow-rate, outdoor side heat exchanger		-	m ³ /h
Emissions of nitrogen oxides(if applicable)	NOx ***	-	mg/kWh fuel input GCV				
GWP of the refrigerant		2088	kg CO _{2eq} (100years)				
Contact details				Mitsubishi heavy industries thermal systems,LTD			
** If Cdh is not determined by measurement then the default degradation coefficient air-conditioners shall be 0,25. *** from 26 September 2018 Where information relates to multi-split air-conditioners, the test result and performance data be obtained on the basis of the performance of the outdoor unit, with a combination of indoor unit(s) recommended by the manufacturer or importer.							

Model(s) : FDC335KXZME1A							
Outdoor side heat exchanger of air conditioner :				air			
Indoor side heat exchanger of air conditioner :				air			
Type : vapour compression							
if applicable : electric motor							
Item	Symbol	Value	Unit	Item	Symbol	Value	Unit
Rated cooling capacity	Prated,c	33.5	kW	Seasonal space cooling energy efficiency	$\eta_{s,c}$	229.8	%
Declared cooling capacity for part load at given outdoor temperatures Tj and indoor 27°C/19°C(dry/wet bulb)				Declared energy efficiency ratio or gas utilization efficiency / auxiliary energy factor for part load at given outdoor temperatures Tj			
Tj=+35°C	Pdc	33.5	kW	Tj=+35°C	EERd or GUEc,bin / AEFc,bin	313.0	%
Tj=+30°C	Pdc	24.6	kW	Tj=+30°C	EERd or GUEc,bin / AEFc,bin	469.0	%
Tj=+25°C	Pdc	15.8	kW	Tj=+25°C	EERd or GUEc,bin / AEFc,bin	712.0	%
Tj=+20°C	Pdc	9.5	kW	Tj=+20°C	EERd or GUEc,bin / AEFc,bin	897.0	%
Degradation coefficient for air conditioners**	Cdc	0.25	-				
Power consumption in other than 'active mode'							
Off mode	P _{OFF}	0.043	kW	Crankcase heater mode	P _{CK}	0.043	kW
Thermostat-off mode	P _{TO}	0.020	kW	Standby mode	P _{SB}	0.043	kW
Other items				For air-to-air air conditioner: air flow-rate,outdoor measured			
Capacity control		variable				12000	m ³ /h
Sound power level, outdoor	L _{WA}	75.0	dB				
If engine driven: Emissions of nitrogen oxides	NO _x ***	-	mg/kWh fuel input GCV				
GWP of the refrigerant		2088	kg CO _{2eq} (100years)				
Contact details	Mitsubishi heavy industries thermal systems,LTD						
<p>** If Cdc is not determined by measurement then the default degradation coefficient air conditioners shall be 0,25.</p> <p>*** from 26 September 2018</p> <p>Where information relates to multi-split air conditioners,the test result and performance data be obtained on the basis of the performance of the outdoor unit, with a combination of indoor unit(s) recommended by the manufacturer or importer.</p>							

Information to identify the model(s) to which the information relates : FDC335KXZME1A							
Outdoor side heat exchanger of heat pump : air							
Indoor side heat exchanger of heat pump : air							
Indication if the heater is equipped with a supplementary heater : No							
if applicable : electric motor							
Parameters shall be declared for the average heating season , parameters for the warmer and colder heating seasons are optional.							
Item	Symbol	Value	Unit	Item	Symbol	Value	Unit
Rated heating capacity	Prated,h	33.5	kW	Seasonal space heating energy efficiency	$\eta_{s,h}$	158.5	%
Declared heating capacity for part load at indoor temperature 20°C and outdoor temperature Tj				Declared coefficient of performance or gas utilization efficiency / auxiliary energy factor for part load at given outdoor temperatures Tj			
Tj=-7°C	Pdh	19.9	kW	Tj=-7°C	COPd or GUEh,bin / AEFh,bin	260.0	%
Tj=+2°C	Pdh	12.2	kW	Tj=+2°C	COPd or GUEh,bin / AEFh,bin	360.0	%
Tj=+7°C	Pdh	7.8	kW	Tj=+7°C	COPd or GUEh,bin / AEFh,bin	621.0	%
Tj=+12°C	Pdh	6.1	kW	Tj=+12°C	COPd or GUEh,bin / AEFh,bin	710.0	%
T _{biv} =bivalent temperature	Pdh	22.5	kW	T _{biv} =bivalent temperature	COPd or GUEh,bin / AEFh,bin	255.0	%
T _{OL} =operation limit	Pdh	16.0	kW	T _{OL} =operation limit	COPd or GUEh,bin / AEFh,bin	205.0	%
For air-to-water heat pumps : Tj=-15°C (if T _{OL} <-20°C)	Pdh	-	kW	For air-to-water heat pumps: Tj=-15°C (if T _{OL} <-20°C)	COPd or GUEh,bin / AEFh,bin	-	%
Bivalent temperature	T _{biv}	-10.0	°C	For water-to-air heat pumps: Operation limit T _{ol} temperature		-	°C
Degradation coefficient heat pumps**	C _{dh}	0.25	-				
Power consumption in modes other than 'active mode'				Supplementary heater back-up heating capacity			
Off mode	P _{OFF}	0.043	kW		elbu	-	kW
Thermostat-off mode	P _{TO}	0.062	kW	Type of energy input Standby mode	P _{SB}	0.043	kW
Crankcase heater mode	P _{CK}	0.043	kW				
Other items				For air-to-air heat pumps: air flow-rate,outdoor measured			
Capacity control		variable				12000	m³/h
Sound power level, outdoor measured	L _{WA}	77.0	dB	For water-/brine-to-air heat pumps : Rated brine or water flow-rate, outdoor side heat exchanger		-	m³/h
Emissions of nitrogen oxides(if applicable)	NOx ***	-	mg/kWh fuel input GCV				
GWP of the refrigerant		2088	kg CO _{2eq} (100years)				
Contact details		Mitsubishi heavy industries thermal systems,LTD					
** If Cdh is not determined by measurement then the default degradation coefficient air conditioners shall be 0,25.							
*** from 26 September 2018							
Where information relates to multi-split air conditioners,the test result and performance data be obtained on the basis of the performance of the outdoor unit, with a combination of indoor unit(s) recommended by the manufacturer or importer.							

PSA012J089B 

7.2 Indoor units

Model(s) : FDT28KXZE1							
Item	Symbol	Value	Unit	Item	Symbol	Value	Unit
Cooling capacity (sensible)	$P_{rated,c}$	2.7	kW	Total electric power input	P_{elec}	0.020	kW
Cooling capacity (latent)	$P_{rated,c}$	0.1	kW	Sound power level (per speed setting,if applicable)	L_{WA}	49.0	dB
Heating capacity	$P_{rated,h}$	3.2	kW				
Contact details	Mitsubishi heavy industries thermal systems,LTD						

Model(s) : FDT36KXZE1							
Item	Symbol	Value	Unit	Item	Symbol	Value	Unit
Cooling capacity (sensible)	$P_{rated,c}$	3.4	kW	Total electric power input	P_{elec}	0.030	kW
Cooling capacity (latent)	$P_{rated,c}$	0.2	kW	Sound power level (per speed setting,if applicable)	L_{WA}	49.0	dB
Heating capacity	$P_{rated,h}$	4.0	kW				
Contact details	Mitsubishi heavy industries thermal systems,LTD						

Model(s) : FDT45KXZE1							
Item	Symbol	Value	Unit	Item	Symbol	Value	Unit
Cooling capacity (sensible)	$P_{rated,c}$	3.8	kW	Total electric power input	P_{elec}	0.030	kW
Cooling capacity (latent)	$P_{rated,c}$	0.7	kW	Sound power level (per speed setting,if applicable)	L_{WA}	50.0	dB
Heating capacity	$P_{rated,h}$	5.0	kW				
Contact details	Mitsubishi heavy industries thermal systems,LTD						

Model(s) : FDT56KXZE1							
Item	Symbol	Value	Unit	Item	Symbol	Value	Unit
Cooling capacity (sensible)	$P_{rated,c}$	4.7	kW	Total electric power input	P_{elec}	0.040	kW
Cooling capacity (latent)	$P_{rated,c}$	0.9	kW	Sound power level (per speed setting,if applicable)	L_{WA}	55.0	dB
Heating capacity	$P_{rated,h}$	6.3	kW				
Contact details	Mitsubishi heavy industries thermal systems,LTD						

Model(s) : FDT71KXZE1							
Item	Symbol	Value	Unit	Item	Symbol	Value	Unit
Cooling capacity (sensible)	$P_{rated,c}$	6.2	kW	Total electric power input	P_{elec}	0.080	kW
Cooling capacity (latent)	$P_{rated,c}$	0.9	kW	Sound power level (per speed setting,if applicable)	L_{WA}	62.0	dB
Heating capacity	$P_{rated,h}$	8.0	kW				
Contact details	Mitsubishi heavy industries thermal systems,LTD						

Model(s) : FDT90KXZE1							
Item	Symbol	Value	Unit	Item	Symbol	Value	Unit
Cooling capacity (sensible)	$P_{rated,c}$	7.9	kW	Total electric power input	P_{elec}	0.130	kW
Cooling capacity (latent)	$P_{rated,c}$	1.1	kW	Sound power level (per speed setting,if applicable)	L_{WA}	65.0	dB
Heating capacity	$P_{rated,h}$	10.0	kW				
Contact details	Mitsubishi heavy industries thermal systems,LTD						

Model(s) : FDT112KXZE1							
Item	Symbol	Value	Unit	Item	Symbol	Value	Unit
Cooling capacity (sensible)	$P_{rated,c}$	9.4	kW	Total electric power input	P_{elec}	0.140	kW
Cooling capacity (latent)	$P_{rated,c}$	1.8	kW	Sound power level (per speed setting,if applicable)	L_{WA}	66.0	dB
Heating capacity	$P_{rated,h}$	12.5	kW				
Contact details	Mitsubishi heavy industries thermal systems,LTD						

Model(s) : FDT140KXZE1							
Item	Symbol	Value	Unit	Item	Symbol	Value	Unit
Cooling capacity (sensible)	$P_{rated,c}$	10.7	kW	Total electric power input	P_{elec}	0.140	kW
Cooling capacity (latent)	$P_{rated,c}$	3.3	kW	Sound power level (per speed setting,if applicable)	L_{WA}	66.0	dB
Heating capacity	$P_{rated,h}$	16.0	kW				
Contact details	Mitsubishi heavy industries thermal systems,LTD						

Model(s) : FDT160KXZE1							
Item	Symbol	Value	Unit	Item	Symbol	Value	Unit
Cooling capacity (sensible)	$P_{rated,c}$	11.5	kW	Total electric power input	P_{elec}	0.140	kW
Cooling capacity (latent)	$P_{rated,c}$	4.5	kW	Sound power level (per speed setting,if applicable)	L_{WA}	66.0	dB
Heating capacity	$P_{rated,h}$	18.0	kW				
Contact details	Mitsubishi heavy industries thermal systems,LTD						

Model(s) : FDUM22KXE6F							
Item	Symbol	Value	Unit	Item	Symbol	Value	Unit
Cooling capacity (sensible)	$P_{rated,c}$	2.1	kW	Total electric power input	P_{elec}	0.100	kW
Cooling capacity (latent)	$P_{rated,c}$	0.1	kW	Sound power level (per speed setting,if applicable)	L_{WA}	60.0	dB
Heating capacity	$P_{rated,h}$	2.5	kW				
Contact details	Mitsubishi heavy industries thermal systems,LTD						

Model(s) : FDUM28KXE6F							
Item	Symbol	Value	Unit	Item	Symbol	Value	Unit
Cooling capacity (sensible)	$P_{rated,c}$	2.7	kW	Total electric power input	P_{elec}	0.100	kW
Cooling capacity (latent)	$P_{rated,c}$	0.1	kW	Sound power level (per speed setting,if applicable)	L_{WA}	60.0	dB
Heating capacity	$P_{rated,h}$	3.2	kW				
Contact details	Mitsubishi heavy industries thermal systems,LTD						

Model(s) : FDUM36KXE6F							
Item	Symbol	Value	Unit	Item	Symbol	Value	Unit
Cooling capacity (sensible)	$P_{rated,c}$	3.3	kW	Total electric power input	P_{elec}	0.100	kW
Cooling capacity (latent)	$P_{rated,c}$	0.3	kW	Sound power level (per speed setting,if applicable)	L_{WA}	60.0	dB
Heating capacity	$P_{rated,h}$	4.0	kW				
Contact details	Mitsubishi heavy industries thermal systems,LTD						

Model(s) : FDUM45KXE6F							
Item	Symbol	Value	Unit	Item	Symbol	Value	Unit
Cooling capacity (sensible)	$P_{rated,c}$	3.7	kW	Total electric power input	P_{elec}	0.100	kW
Cooling capacity (latent)	$P_{rated,c}$	0.8	kW	Sound power level (per speed setting,if applicable)	L_{WA}	60.0	dB
Heating capacity	$P_{rated,h}$	5.0	kW				
Contact details	Mitsubishi heavy industries thermal systems,LTD						

Model(s) : FDUM56KXE6F							
Item	Symbol	Value	Unit	Item	Symbol	Value	Unit
Cooling capacity (sensible)	$P_{rated,c}$	4.1	kW	Total electric power input	P_{elec}	0.100	kW
Cooling capacity (latent)	$P_{rated,c}$	1.5	kW	Sound power level (per speed setting,if applicable)	L_{WA}	60.0	dB
Heating capacity	$P_{rated,h}$	6.3	kW				
Contact details	Mitsubishi heavy industries thermal systems,LTD						

Model(s) : FDUM71KXE6F							
Item	Symbol	Value	Unit	Item	Symbol	Value	Unit
Cooling capacity (sensible)	$P_{rated,c}$	6.0	kW	Total electric power input	P_{elec}	0.200	kW
Cooling capacity (latent)	$P_{rated,c}$	1.1	kW	Sound power level (per speed setting,if applicable)	L_{WA}	65.0	dB
Heating capacity	$P_{rated,h}$	8.0	kW				
Contact details	Mitsubishi heavy industries thermal systems,LTD						

Model(s) : FDUM90KXE6F							
Item	Symbol	Value	Unit	Item	Symbol	Value	Unit
Cooling capacity (sensible)	$P_{rated,c}$	6.7	kW	Total electric power input	P_{elec}	0.200	kW
Cooling capacity (latent)	$P_{rated,c}$	2.3	kW	Sound power level (per speed setting,if applicable)	L_{WA}	65.0	dB
Heating capacity	$P_{rated,h}$	10.0	kW				
Contact details	Mitsubishi heavy industries thermal systems,LTD						

Model(s) : FDUM112KXE6F							
Item	Symbol	Value	Unit	Item	Symbol	Value	Unit
Cooling capacity (sensible)	$P_{rated,c}$	8.6	kW	Total electric power input	P_{elec}	0.290	kW
Cooling capacity (latent)	$P_{rated,c}$	2.6	kW	Sound power level (per speed setting,if applicable)	L_{WA}	67.0	dB
Heating capacity	$P_{rated,h}$	12.5	kW				
Contact details	Mitsubishi heavy industries thermal systems,LTD						

Model(s) : FDUM140KXE6F							
Item	Symbol	Value	Unit	Item	Symbol	Value	Unit
Cooling capacity (sensible)	$P_{rated,c}$	11.2	kW	Total electric power input	P_{elec}	0.330	kW
Cooling capacity (latent)	$P_{rated,c}$	2.8	kW	Sound power level (per speed setting,if applicable)	L_{WA}	72.0	dB
Heating capacity	$P_{rated,h}$	16.0	kW				
Contact details	Mitsubishi heavy industries thermal systems,LTD						

Model(s) : FDUM160KXE6F							
Item	Symbol	Value	Unit	Item	Symbol	Value	Unit
Cooling capacity (sensible)	$P_{rated,c}$	12.4	kW	Total electric power input	P_{elec}	0.450	kW
Cooling capacity (latent)	$P_{rated,c}$	3.6	kW	Sound power level (per speed setting,if applicable)	L_{WA}	76.0	dB
Heating capacity	$P_{rated,h}$	18.0	kW				
Contact details	Mitsubishi heavy industries thermal systems,LTD						

Model(s) : FDU224KXZE1							
Item	Symbol	Value	Unit	Item	Symbol	Value	Unit
Cooling capacity (sensible)	$P_{rated,c}$	19.7	kW	Total electric power input	P_{elec}	1.180	kW
Cooling capacity (latent)	$P_{rated,c}$	2.7	kW	Sound power level (per speed setting,if applicable)	L_{WA}	75.0	dB
Heating capacity	$P_{rated,h}$	25.0	kW				
Contact details	Mitsubishi heavy industries thermal systems,LTD						

Model(s) : FDU280KXZE1							
Item	Symbol	Value	Unit	Item	Symbol	Value	Unit
Cooling capacity (sensible)	$P_{rated,c}$	21.9	kW	Total electric power input	P_{elec}	1.180	kW
Cooling capacity (latent)	$P_{rated,c}$	6.1	kW	Sound power level (per speed setting,if applicable)	L_{WA}	75.0	dB
Heating capacity	$P_{rated,h}$	31.5	kW				
Contact details	Mitsubishi heavy industries thermal systems,LTD						

Model(s) : FDK15KXZE1							
Item	Symbol	Value	Unit	Item	Symbol	Value	Unit
Cooling capacity (sensible)	$P_{rated,c}$	1.2	kW	Total electric power input	P_{elec}	0.020	kW
Cooling capacity (latent)	$P_{rated,c}$	0.3	kW	Sound power level (per speed setting,if applicable)	L_{WA}	54.0	dB
Heating capacity	$P_{rated,h}$	1.7	kW				
Contact details	Mitsubishi heavy industries thermal systems,LTD						

Model(s) : FDK22KXZE1							
Item	Symbol	Value	Unit	Item	Symbol	Value	Unit
Cooling capacity (sensible)	$P_{rated,c}$	1.8	kW	Total electric power input	P_{elec}	0.020	kW
Cooling capacity (latent)	$P_{rated,c}$	0.4	kW	Sound power level (per speed setting,if applicable)	L_{WA}	55.0	dB
Heating capacity	$P_{rated,h}$	2.5	kW				
Contact details	Mitsubishi heavy industries thermal systems,LTD						

Model(s) : FDK28KXZE1							
Item	Symbol	Value	Unit	Item	Symbol	Value	Unit
Cooling capacity (sensible)	$P_{rated,c}$	2.2	kW	Total electric power input	P_{elec}	0.020	kW
Cooling capacity (latent)	$P_{rated,c}$	0.6	kW	Sound power level (per speed setting,if applicable)	L_{WA}	55.0	dB
Heating capacity	$P_{rated,h}$	3.2	kW				
Contact details	Mitsubishi heavy industries thermal systems,LTD						

Model(s) : FDK36KXZE1							
Item	Symbol	Value	Unit	Item	Symbol	Value	Unit
Cooling capacity (sensible)	$P_{rated,c}$	2.8	kW	Total electric power input	P_{elec}	0.030	kW
Cooling capacity (latent)	$P_{rated,c}$	0.8	kW	Sound power level (per speed setting,if applicable)	L_{WA}	58.0	dB
Heating capacity	$P_{rated,h}$	4.0	kW				
Contact details	Mitsubishi heavy industries thermal systems,LTD						

Model(s) : FDK45KXZE1							
Item	Symbol	Value	Unit	Item	Symbol	Value	Unit
Cooling capacity (sensible)	$P_{rated,c}$	3.3	kW	Total electric power input	P_{elec}	0.030	kW
Cooling capacity (latent)	$P_{rated,c}$	1.2	kW	Sound power level (per speed setting,if applicable)	L_{WA}	58.0	dB
Heating capacity	$P_{rated,h}$	5.0	kW				
Contact details	Mitsubishi heavy industries thermal systems,LTD						

Model(s) : FDK56KXZE1							
Item	Symbol	Value	Unit	Item	Symbol	Value	Unit
Cooling capacity (sensible)	$P_{rated,c}$	3.9	kW	Total electric power input	P_{elec}	0.030	kW
Cooling capacity (latent)	$P_{rated,c}$	1.7	kW	Sound power level (per speed setting,if applicable)	L_{WA}	58.0	dB
Heating capacity	$P_{rated,h}$	6.3	kW				
Contact details	Mitsubishi heavy industries thermal systems,LTD						

Model(s) : FDK71KXZE1							
Item	Symbol	Value	Unit	Item	Symbol	Value	Unit
Cooling capacity (sensible)	$P_{rated,c}$	5.4	kW	Total electric power input	P_{elec}	0.040	kW
Cooling capacity (latent)	$P_{rated,c}$	1.7	kW	Sound power level (per speed setting,if applicable)	L_{WA}	59.0	dB
Heating capacity	$P_{rated,h}$	8.0	kW				
Contact details	Mitsubishi heavy industries thermal systems,LTD						

Model(s) : FDK90KXZE1							
Item	Symbol	Value	Unit	Item	Symbol	Value	Unit
Cooling capacity (sensible)	$P_{rated,c}$	6.5	kW	Total electric power input	P_{elec}	0.050	kW
Cooling capacity (latent)	$P_{rated,c}$	2.5	kW	Sound power level (per speed setting,if applicable)	L_{WA}	61.0	dB
Heating capacity	$P_{rated,h}$	10.0	kW				
Contact details	Mitsubishi heavy industries thermal systems,LTD						

Model(s) : FDTC15KXZE1							
Item	Symbol	Value	Unit	Item	Symbol	Value	Unit
Cooling capacity (sensible)	$P_{rated,c}$	1.4	kW	Total electric power input	P_{elec}	0.030	kW
Cooling capacity (latent)	$P_{rated,c}$	0.1	kW	Sound power level (per speed setting,if applicable)	L_{WA}	47.0	dB
Heating capacity	$P_{rated,h}$	1.7	kW				
Contact details	Mitsubishi heavy industries thermal systems,LTD						

Model(s) : FDTC22KXZE1							
Item	Symbol	Value	Unit	Item	Symbol	Value	Unit
Cooling capacity (sensible)	$P_{rated,c}$	2.1	kW	Total electric power input	P_{elec}	0.030	kW
Cooling capacity (latent)	$P_{rated,c}$	0.1	kW	Sound power level (per speed setting,if applicable)	L_{WA}	49.0	dB
Heating capacity	$P_{rated,h}$	2.5	kW				
Contact details	Mitsubishi heavy industries thermal systems,LTD						

Model(s) : FDTC28KXZE1							
Item	Symbol	Value	Unit	Item	Symbol	Value	Unit
Cooling capacity (sensible)	$P_{rated,c}$	2.4	kW	Total electric power input	P_{elec}	0.030	kW
Cooling capacity (latent)	$P_{rated,c}$	0.4	kW	Sound power level (per speed setting,if applicable)	L_{WA}	49.0	dB
Heating capacity	$P_{rated,h}$	3.2	kW				
Contact details	Mitsubishi heavy industries thermal systems,LTD						

Model(s) : FDTC36KXZE1							
Item	Symbol	Value	Unit	Item	Symbol	Value	Unit
Cooling capacity (sensible)	$P_{rated,c}$	2.9	kW	Total electric power input	P_{elec}	0.040	kW
Cooling capacity (latent)	$P_{rated,c}$	0.7	kW	Sound power level (per speed setting,if applicable)	L_{WA}	54.0	dB
Heating capacity	$P_{rated,h}$	4.0	kW				
Contact details	Mitsubishi heavy industries thermal systems,LTD						

Model(s) : FDTC45KXZE1							
Item	Symbol	Value	Unit	Item	Symbol	Value	Unit
Cooling capacity (sensible)	$P_{rated,c}$	3.5	kW	Total electric power input	P_{elec}	0.050	kW
Cooling capacity (latent)	$P_{rated,c}$	1.0	kW	Sound power level (per speed setting,if applicable)	L_{WA}	58.0	dB
Heating capacity	$P_{rated,h}$	5.0	kW				
Contact details	Mitsubishi heavy industries thermal systems,LTD						

Model(s) : FDTC56KXZE1							
Item	Symbol	Value	Unit	Item	Symbol	Value	Unit
Cooling capacity (sensible)	$P_{rated,c}$	4.2	kW	Total electric power input	P_{elec}	0.060	kW
Cooling capacity (latent)	$P_{rated,c}$	1.4	kW	Sound power level (per speed setting,if applicable)	L_{WA}	60.0	dB
Heating capacity	$P_{rated,h}$	6.3	kW				
Contact details	Mitsubishi heavy industries thermal systems,LTD						

Model(s) : FDTW28KXE6F							
Item	Symbol	Value	Unit	Item	Symbol	Value	Unit
Cooling capacity (sensible)	$P_{rated,c}$	2.3	kW	Total electric power input	P_{elec}	0.090	kW
Cooling capacity (latent)	$P_{rated,c}$	0.5	kW	Sound power level (per speed setting,if applicable)	L_{WA}	58.0	dB
Heating capacity	$P_{rated,h}$	3.2	kW				
Contact details	Mitsubishi heavy industries thermal systems,LTD						

Model(s) : FDTW45KXE6F							
Item	Symbol	Value	Unit	Item	Symbol	Value	Unit
Cooling capacity (sensible)	$P_{rated,c}$	3.4	kW	Total electric power input	P_{elec}	0.100	kW
Cooling capacity (latent)	$P_{rated,c}$	1.1	kW	Sound power level (per speed setting,if applicable)	L_{WA}	58.0	dB
Heating capacity	$P_{rated,h}$	5.0	kW				
Contact details	Mitsubishi heavy industries thermal systems,LTD						

Model(s) : FDTW56KXE6F							
Item	Symbol	Value	Unit	Item	Symbol	Value	Unit
Cooling capacity (sensible)	$P_{rated,c}$	4.0	kW	Total electric power input	P_{elec}	0.100	kW
Cooling capacity (latent)	$P_{rated,c}$	1.6	kW	Sound power level (per speed setting,if applicable)	L_{WA}	58.0	dB
Heating capacity	$P_{rated,h}$	6.3	kW				
Contact details	Mitsubishi heavy industries thermal systems,LTD						

Model(s) : FDTW71KXE6F							
Item	Symbol	Value	Unit	Item	Symbol	Value	Unit
Cooling capacity (sensible)	$P_{rated,c}$	4.8	kW	Total electric power input	P_{elec}	0.140	kW
Cooling capacity (latent)	$P_{rated,c}$	2.3	kW	Sound power level (per speed setting,if applicable)	L_{WA}	58.0	dB
Heating capacity	$P_{rated,h}$	8.0	kW				
Contact details	Mitsubishi heavy industries thermal systems,LTD						

Model(s) : FDTW90KXE6F							
Item	Symbol	Value	Unit	Item	Symbol	Value	Unit
Cooling capacity (sensible)	$P_{rated,c}$	6.8	kW	Total electric power input	P_{elec}	0.190	kW
Cooling capacity (latent)	$P_{rated,c}$	2.2	kW	Sound power level (per speed setting,if applicable)	L_{WA}	65.0	dB
Heating capacity	$P_{rated,h}$	10.0	kW				
Contact details	Mitsubishi heavy industries thermal systems,LTD						

Model(s) : FDTW112KXE6F							
Item	Symbol	Value	Unit	Item	Symbol	Value	Unit
Cooling capacity (sensible)	$P_{rated,c}$	8.1	kW	Total electric power input	P_{elec}	0.190	kW
Cooling capacity (latent)	$P_{rated,c}$	3.1	kW	Sound power level (per speed setting,if applicable)	L_{WA}	65.0	dB
Heating capacity	$P_{rated,h}$	12.5	kW				
Contact details	Mitsubishi heavy industries thermal systems,LTD						

Model(s) : FDTW140KXE6F							
Item	Symbol	Value	Unit	Item	Symbol	Value	Unit
Cooling capacity (sensible)	$P_{rated,c}$	9.9	kW	Total electric power input	P_{elec}	0.190	kW
Cooling capacity (latent)	$P_{rated,c}$	4.1	kW	Sound power level (per speed setting,if applicable)	L_{WA}	65.0	dB
Heating capacity	$P_{rated,h}$	16.0	kW				
Contact details	Mitsubishi heavy industries thermal systems,LTD						

Model(s) : FDTS45KXE6F							
Item	Symbol	Value	Unit	Item	Symbol	Value	Unit
Cooling capacity (sensible)	$P_{rated,c}$	3.3	kW	Total electric power input	P_{elec}	0.040	kW
Cooling capacity (latent)	$P_{rated,c}$	1.2	kW	Sound power level (per speed setting,if applicable)	L_{WA}	60.0	dB
Heating capacity	$P_{rated,h}$	5.0	kW				
Contact details	Mitsubishi heavy industries thermal systems,LTD						

Model(s) : FDTS71KXE6F							
Item	Symbol	Value	Unit	Item	Symbol	Value	Unit
Cooling capacity (sensible)	$P_{rated,c}$	5.0	kW	Total electric power input	P_{elec}	0.090	kW
Cooling capacity (latent)	$P_{rated,c}$	2.1	kW	Sound power level (per speed setting,if applicable)	L_{WA}	61.0	dB
Heating capacity	$P_{rated,h}$	8.0	kW				
Contact details	Mitsubishi heavy industries thermal systems,LTD						

Model(s) : FDTQ22KXE6F							
Item	Symbol	Value	Unit	Item	Symbol	Value	Unit
Cooling capacity (sensible)	$P_{rated,c}$	1.8	kW	Total electric power input	P_{elec}	0.060	kW
Cooling capacity (latent)	$P_{rated,c}$	0.4	kW	Sound power level (per speed setting,if applicable)	L_{WA}	60.0	dB
Heating capacity	$P_{rated,h}$	2.5	kW				
Contact details	Mitsubishi heavy industries thermal systems,LTD						

Model(s) : FDTQ28KXE6F							
Item	Symbol	Value	Unit	Item	Symbol	Value	Unit
Cooling capacity (sensible)	$P_{rated,c}$	2.1	kW	Total electric power input	P_{elec}	0.060	kW
Cooling capacity (latent)	$P_{rated,c}$	0.7	kW	Sound power level (per speed setting,if applicable)	L_{WA}	60.0	dB
Heating capacity	$P_{rated,h}$	3.2	kW				
Contact details	Mitsubishi heavy industries thermal systems,LTD						

Model(s) : FDTQ36KXE6F							
Item	Symbol	Value	Unit	Item	Symbol	Value	Unit
Cooling capacity (sensible)	$P_{rated,c}$	2.5	kW	Total electric power input	P_{elec}	0.060	kW
Cooling capacity (latent)	$P_{rated,c}$	1.1	kW	Sound power level (per speed setting,if applicable)	L_{WA}	60.0	dB
Heating capacity	$P_{rated,h}$	4.0	kW				
Contact details	Mitsubishi heavy industries thermal systems,LTD						

Model(s) : FDFL71KXE6F							
Item	Symbol	Value	Unit	Item	Symbol	Value	Unit
Cooling capacity (sensible)	$P_{rated,c}$	5.3	kW	Total electric power input	P_{elec}	0.100	kW
Cooling capacity (latent)	$P_{rated,c}$	1.8	kW	Sound power level (per speed setting,if applicable)	L_{WA}	62.0	dB
Heating capacity	$P_{rated,h}$	8.0	kW				
Contact details	Mitsubishi heavy industries thermal systems,LTD						

Model(s) : FDFU28KXE6F							
Item	Symbol	Value	Unit	Item	Symbol	Value	Unit
Cooling capacity (sensible)	$P_{rated,c}$	2.7	kW	Total electric power input	P_{elec}	0.100	kW
Cooling capacity (latent)	$P_{rated,c}$	0.1	kW	Sound power level (per speed setting,if applicable)	L_{WA}	58.0	dB
Heating capacity	$P_{rated,h}$	3.2	kW				
Contact details	Mitsubishi heavy industries thermal systems,LTD						

Model(s) : FDFU45KXE6F							
Item	Symbol	Value	Unit	Item	Symbol	Value	Unit
Cooling capacity (sensible)	$P_{rated,c}$	3.8	kW	Total electric power input	P_{elec}	0.100	kW
Cooling capacity (latent)	$P_{rated,c}$	0.7	kW	Sound power level (per speed setting,if applicable)	L_{WA}	60.0	dB
Heating capacity	$P_{rated,h}$	5.0	kW				
Contact details	Mitsubishi heavy industries thermal systems,LTD						

Model(s) : FDFU56KXE6F							
Item	Symbol	Value	Unit	Item	Symbol	Value	Unit
Cooling capacity (sensible)	$P_{rated,c}$	4.2	kW	Total electric power input	P_{elec}	0.100	kW
Cooling capacity (latent)	$P_{rated,c}$	1.4	kW	Sound power level (per speed setting,if applicable)	L_{WA}	60.0	dB
Heating capacity	$P_{rated,h}$	6.3	kW				
Contact details	Mitsubishi heavy industries thermal systems,LTD						

Model(s) : FDFU71KXE6F							
Item	Symbol	Value	Unit	Item	Symbol	Value	Unit
Cooling capacity (sensible)	$P_{rated,c}$	5.3	kW	Total electric power input	P_{elec}	0.100	kW
Cooling capacity (latent)	$P_{rated,c}$	1.8	kW	Sound power level (per speed setting,if applicable)	L_{WA}	60.0	dB
Heating capacity	$P_{rated,h}$	8.0	kW				
Contact details	Mitsubishi heavy industries thermal systems,LTD						

Model(s) : FDU45KXE6F							
Item	Symbol	Value	Unit	Item	Symbol	Value	Unit
Cooling capacity (sensible)	$P_{rated,c}$	3.7	kW	Total electric power input	P_{elec}	0.100	kW
Cooling capacity (latent)	$P_{rated,c}$	0.8	kW	Sound power level (per speed setting,if applicable)	L_{WA}	60.0	dB
Heating capacity	$P_{rated,h}$	5.0	kW				
Contact details	Mitsubishi heavy industries thermal systems,LTD						

Model(s) : FDU56KXE6F							
Item	Symbol	Value	Unit	Item	Symbol	Value	Unit
Cooling capacity (sensible)	$P_{rated,c}$	4.1	kW	Total electric power input	P_{elec}	0.100	kW
Cooling capacity (latent)	$P_{rated,c}$	1.5	kW	Sound power level (per speed setting,if applicable)	L_{WA}	60.0	dB
Heating capacity	$P_{rated,h}$	6.3	kW				
Contact details	Mitsubishi heavy industries thermal systems,LTD						

Model(s) : FDU71KXE6F							
Item	Symbol	Value	Unit	Item	Symbol	Value	Unit
Cooling capacity (sensible)	$P_{rated,c}$	6.0	kW	Total electric power input	P_{elec}	0.250	kW
Cooling capacity (latent)	$P_{rated,c}$	1.1	kW	Sound power level (per speed setting,if applicable)	L_{WA}	65.0	dB
Heating capacity	$P_{rated,h}$	8.0	kW				
Contact details	Mitsubishi heavy industries thermal systems,LTD						

Model(s) : FDU90KXE6F							
Item	Symbol	Value	Unit	Item	Symbol	Value	Unit
Cooling capacity (sensible)	$P_{rated,c}$	6.7	kW	Total electric power input	P_{elec}	0.250	kW
Cooling capacity (latent)	$P_{rated,c}$	2.3	kW	Sound power level (per speed setting,if applicable)	L_{WA}	65.0	dB
Heating capacity	$P_{rated,h}$	10.0	kW				
Contact details	Mitsubishi heavy industries thermal systems,LTD						

Model(s) : FDU112KXE6F							
Item	Symbol	Value	Unit	Item	Symbol	Value	Unit
Cooling capacity (sensible)	$P_{rated,c}$	8.6	kW	Total electric power input	P_{elec}	0.320	kW
Cooling capacity (latent)	$P_{rated,c}$	2.6	kW	Sound power level (per speed setting,if applicable)	L_{WA}	67.0	dB
Heating capacity	$P_{rated,h}$	12.5	kW				
Contact details	Mitsubishi heavy industries thermal systems,LTD						

Model(s) : FDU140KXE6F							
Item	Symbol	Value	Unit	Item	Symbol	Value	Unit
Cooling capacity (sensible)	$P_{rated,c}$	11.2	kW	Total electric power input	P_{elec}	0.360	kW
Cooling capacity (latent)	$P_{rated,c}$	2.8	kW	Sound power level (per speed setting,if applicable)	L_{WA}	72.0	dB
Heating capacity	$P_{rated,h}$	16.0	kW				
Contact details	Mitsubishi heavy industries thermal systems,LTD						

Model(s) : FDU160KXE6F							
Item	Symbol	Value	Unit	Item	Symbol	Value	Unit
Cooling capacity (sensible)	$P_{rated,c}$	12.4	kW	Total electric power input	P_{elec}	0.430	kW
Cooling capacity (latent)	$P_{rated,c}$	3.6	kW	Sound power level (per speed setting,if applicable)	L_{WA}	76.0	dB
Heating capacity	$P_{rated,h}$	18.0	kW				
Contact details	Mitsubishi heavy industries thermal systems,LTD						

Model(s) : FDUT15KXE6F-E							
Item	Symbol	Value	Unit	Item	Symbol	Value	Unit
Cooling capacity (sensible)	$P_{rated,c}$	1.2	kW	Total electric power input	P_{elec}	0.060	kW
Cooling capacity (latent)	$P_{rated,c}$	0.3	kW	Sound power level (per speed setting,if applicable)	L_{WA}	52.0	dB
Heating capacity	$P_{rated,h}$	1.7	kW				
Contact details	Mitsubishi heavy industries thermal systems,LTD						

Model(s) : FDUT22KXE6F-E							
Item	Symbol	Value	Unit	Item	Symbol	Value	Unit
Cooling capacity (sensible)	$P_{rated,c}$	1.7	kW	Total electric power input	P_{elec}	0.070	kW
Cooling capacity (latent)	$P_{rated,c}$	0.5	kW	Sound power level (per speed setting,if applicable)	L_{WA}	52.0	dB
Heating capacity	$P_{rated,h}$	2.5	kW				
Contact details	Mitsubishi heavy industries thermal systems,LTD						

Model(s) : FDUT28KXE6F-E							
Item	Symbol	Value	Unit	Item	Symbol	Value	Unit
Cooling capacity (sensible)	$P_{rated,c}$	2.0	kW	Total electric power input	P_{elec}	0.070	kW
Cooling capacity (latent)	$P_{rated,c}$	0.8	kW	Sound power level (per speed setting,if applicable)	L_{WA}	52.0	dB
Heating capacity	$P_{rated,h}$	3.2	kW				
Contact details	Mitsubishi heavy industries thermal systems,LTD						

Model(s) : FDUT36KXE6F-E							
Item	Symbol	Value	Unit	Item	Symbol	Value	Unit
Cooling capacity (sensible)	$P_{rated,c}$	2.5	kW	Total electric power input	P_{elec}	0.070	kW
Cooling capacity (latent)	$P_{rated,c}$	1.1	kW	Sound power level (per speed setting,if applicable)	L_{WA}	57.0	dB
Heating capacity	$P_{rated,h}$	4.0	kW				
Contact details	Mitsubishi heavy industries thermal systems,LTD						

Model(s) : FDUT45KXE6F-E							
Item	Symbol	Value	Unit	Item	Symbol	Value	Unit
Cooling capacity (sensible)	$P_{rated,c}$	3.2	kW	Total electric power input	P_{elec}	0.080	kW
Cooling capacity (latent)	$P_{rated,c}$	1.3	kW	Sound power level (per speed setting,if applicable)	L_{WA}	58.0	dB
Heating capacity	$P_{rated,h}$	5.0	kW				
Contact details	Mitsubishi heavy industries thermal systems,LTD						

Model(s) : FDUT56KXE6F-E							
Item	Symbol	Value	Unit	Item	Symbol	Value	Unit
Cooling capacity (sensible)	$P_{rated,c}$	3.9	kW	Total electric power input	P_{elec}	0.080	kW
Cooling capacity (latent)	$P_{rated,c}$	1.7	kW	Sound power level (per speed setting,if applicable)	L_{WA}	59.0	dB
Heating capacity	$P_{rated,h}$	6.0	kW				
Contact details	Mitsubishi heavy industries thermal systems,LTD						

Model(s) : FDUT71KXE6F-E							
Item	Symbol	Value	Unit	Item	Symbol	Value	Unit
Cooling capacity (sensible)	$P_{rated,c}$	4.9	kW	Total electric power input	P_{elec}	0.080	kW
Cooling capacity (latent)	$P_{rated,c}$	2.2	kW	Sound power level (per speed setting,if applicable)	L_{WA}	59.0	dB
Heating capacity	$P_{rated,h}$	8.0	kW				
Contact details	Mitsubishi heavy industries thermal systems,LTD						

Model(s) : FDUH22KXE6F							
Item	Symbol	Value	Unit	Item	Symbol	Value	Unit
Cooling capacity (sensible)	$P_{rated,c}$	1.8	kW	Total electric power input	P_{elec}	0.060	kW
Cooling capacity (latent)	$P_{rated,c}$	0.4	kW	Sound power level (per speed setting,if applicable)	L_{WA}	60.0	dB
Heating capacity	$P_{rated,h}$	2.5	kW				
Contact details	Mitsubishi heavy industries thermal systems,LTD						

Model(s) : FDUH28KXE6F							
Item	Symbol	Value	Unit	Item	Symbol	Value	Unit
Cooling capacity (sensible)	$P_{rated,c}$	2.2	kW	Total electric power input	P_{elec}	0.060	kW
Cooling capacity (latent)	$P_{rated,c}$	0.6	kW	Sound power level (per speed setting,if applicable)	L_{WA}	60.0	dB
Heating capacity	$P_{rated,h}$	3.2	kW				
Contact details	Mitsubishi heavy industries thermal systems,LTD						

Model(s) : FDUH36KXE6F							
Item	Symbol	Value	Unit	Item	Symbol	Value	Unit
Cooling capacity (sensible)	$P_{rated,c}$	2.6	kW	Total electric power input	P_{elec}	0.060	kW
Cooling capacity (latent)	$P_{rated,c}$	1.0	kW	Sound power level (per speed setting,if applicable)	L_{WA}	60.0	dB
Heating capacity	$P_{rated,h}$	4.0	kW				
Contact details	Mitsubishi heavy industries thermal systems,LTD						

Model(s) : FDFW28KXE6F							
Item	Symbol	Value	Unit	Item	Symbol	Value	Unit
Cooling capacity (sensible)	$P_{rated,c}$	2.3	kW	Total electric power input	P_{elec}	0.020	kW
Cooling capacity (latent)	$P_{rated,c}$	0.5	kW	Sound power level (per speed setting,if applicable)	L_{WA}	55.0	dB
Heating capacity	$P_{rated,h}$	3.2	kW				
Contact details	Mitsubishi heavy industries thermal systems,LTD						

Model(s) : FDFW45KXE6F							
Item	Symbol	Value	Unit	Item	Symbol	Value	Unit
Cooling capacity (sensible)	$P_{rated,c}$	3.0	kW	Total electric power input	P_{elec}	0.020	kW
Cooling capacity (latent)	$P_{rated,c}$	1.5	kW	Sound power level (per speed setting,if applicable)	L_{WA}	57.0	dB
Heating capacity	$P_{rated,h}$	5.0	kW				
Contact details	Mitsubishi heavy industries thermal systems,LTD						

Model(s) : FDFW56KXE6F							
Item	Symbol	Value	Unit	Item	Symbol	Value	Unit
Cooling capacity (sensible)	$P_{rated,c}$	3.8	kW	Total electric power input	P_{elec}	0.030	kW
Cooling capacity (latent)	$P_{rated,c}$	1.8	kW	Sound power level (per speed setting,if applicable)	L_{WA}	60.0	dB
Heating capacity	$P_{rated,h}$	6.3	kW				
Contact details	Mitsubishi heavy industries thermal systems,LTD						

Model(s) : FDE36KXZE1							
Item	Symbol	Value	Unit	Item	Symbol	Value	Unit
Cooling capacity (sensible)	$P_{rated,c}$	2.7	kW	Total electric power input	P_{elec}	0.050	kW
Cooling capacity (latent)	$P_{rated,c}$	0.9	kW	Sound power level (per speed setting,if applicable)	L_{WA}	60.0	dB
Heating capacity	$P_{rated,h}$	4.0	kW				
Contact details	Mitsubishi heavy industries thermal systems,LTD						

Model(s) : FDE45KXZE1							
Item	Symbol	Value	Unit	Item	Symbol	Value	Unit
Cooling capacity (sensible)	$P_{rated,c}$	3.3	kW	Total electric power input	P_{elec}	0.050	kW
Cooling capacity (latent)	$P_{rated,c}$	1.2	kW	Sound power level (per speed setting,if applicable)	L_{WA}	60.0	dB
Heating capacity	$P_{rated,h}$	5.0	kW				
Contact details	Mitsubishi heavy industries thermal systems,LTD						

Model(s) : FDE56KXZE1							
Item	Symbol	Value	Unit	Item	Symbol	Value	Unit
Cooling capacity (sensible)	$P_{rated,c}$	3.9	kW	Total electric power input	P_{elec}	0.050	kW
Cooling capacity (latent)	$P_{rated,c}$	1.7	kW	Sound power level (per speed setting,if applicable)	L_{WA}	60.0	dB
Heating capacity	$P_{rated,h}$	6.3	kW				
Contact details	Mitsubishi heavy industries thermal systems,LTD						

Model(s) : FDE71KXZE1							
Item	Symbol	Value	Unit	Item	Symbol	Value	Unit
Cooling capacity (sensible)	$P_{rated,c}$	5.2	kW	Total electric power input	P_{elec}	0.070	kW
Cooling capacity (latent)	$P_{rated,c}$	1.9	kW	Sound power level (per speed setting,if applicable)	L_{WA}	62.0	dB
Heating capacity	$P_{rated,h}$	8.0	kW				
Contact details	Mitsubishi heavy industries thermal systems,LTD						

Model(s) : FDE112KXZE1							
Item	Symbol	Value	Unit	Item	Symbol	Value	Unit
Cooling capacity (sensible)	$P_{rated,c}$	7.9	kW	Total electric power input	P_{elec}	0.100	kW
Cooling capacity (latent)	$P_{rated,c}$	3.3	kW	Sound power level (per speed setting,if applicable)	L_{WA}	63.0	dB
Heating capacity	$P_{rated,h}$	12.5	kW				
Contact details	Mitsubishi heavy industries thermal systems,LTD						

Model(s) : FDE140KXZE1							
Item	Symbol	Value	Unit	Item	Symbol	Value	Unit
Cooling capacity (sensible)	$P_{rated,c}$	9.8	kW	Total electric power input	P_{elec}	0.130	kW
Cooling capacity (latent)	$P_{rated,c}$	4.2	kW	Sound power level (per speed setting,if applicable)	L_{WA}	66.0	dB
Heating capacity	$P_{rated,h}$	16.0	kW				
Contact details	Mitsubishi heavy industries thermal systems,LTD						

Model(s) : FDU650FKXZE1							
Item	Symbol	Value	Unit	Item	Symbol	Value	Unit
Cooling capacity (sensible)	$P_{rated,c}$	3.2	kW	Total electric power input	P_{elec}	0.250	kW
Cooling capacity (latent)	$P_{rated,c}$	5.8	kW	Sound power level (per speed setting,if applicable)	L_{WA}	62.0	dB
Heating capacity	$P_{rated,h}$	6.5	kW				
Contact details	Mitsubishi heavy industries thermal systems,LTD						

Model(s) : FDU1100FKXZE1							
Item	Symbol	Value	Unit	Item	Symbol	Value	Unit
Cooling capacity (sensible)	$P_{rated,c}$	4.1	kW	Total electric power input	P_{elec}	0.360	kW
Cooling capacity (latent)	$P_{rated,c}$	9.9	kW	Sound power level (per speed setting,if applicable)	L_{WA}	66.0	dB
Heating capacity	$P_{rated,h}$	10.5	kW				
Contact details	Mitsubishi heavy industries thermal systems,LTD						

Model(s) : FDU1800FKXZE1							
Item	Symbol	Value	Unit	Item	Symbol	Value	Unit
Cooling capacity (sensible)	$P_{rated,c}$	7.4	kW	Total electric power input	P_{elec}	1.180	kW
Cooling capacity (latent)	$P_{rated,c}$	15.1	kW	Sound power level (per speed setting,if applicable)	L_{WA}	70.0	dB
Heating capacity	$P_{rated,h}$	16.0	kW				
Contact details	Mitsubishi heavy industries thermal systems,LTD						

Model(s) : FDU2400FKXZE1							
Item	Symbol	Value	Unit	Item	Symbol	Value	Unit
Cooling capacity (sensible)	$P_{rated,c}$	9.3	kW	Total electric power input	P_{elec}	1.180	kW
Cooling capacity (latent)	$P_{rated,c}$	18.7	kW	Sound power level (per speed setting,if applicable)	L_{WA}	73.0	dB
Heating capacity	$P_{rated,h}$	21.5	kW				
Contact details	Mitsubishi heavy industries thermal systems,LTD						

Model(s) : SAF-DX250E6							
Item	Symbol	Value	Unit	Item	Symbol	Value	Unit
Cooling capacity (sensible)	$P_{rated,c}$	1.3	kW	Total electric power input	P_{elec}	0.007	kW
Cooling capacity (latent)	$P_{rated,c}$	0.7	kW	Sound power level (per speed setting,if applicable)	L_{WA}	-	dB
Heating capacity	$P_{rated,h}$	1.8	kW				
Contact details	Mitsubishi heavy industries thermal systems,LTD						

Model(s) : SAF-DX350E6							
Item	Symbol	Value	Unit	Item	Symbol	Value	Unit
Cooling capacity (sensible)	$P_{rated,c}$	1.8	kW	Total electric power input	P_{elec}	0.007	kW
Cooling capacity (latent)	$P_{rated,c}$	1.0	kW	Sound power level (per speed setting,if applicable)	L_{WA}	-	dB
Heating capacity	$P_{rated,h}$	2.2	kW				
Contact details	Mitsubishi heavy industries thermal systems,LTD						

Model(s) : SAF-DX500E6							
Item	Symbol	Value	Unit	Item	Symbol	Value	Unit
Cooling capacity (sensible)	$P_{rated,c}$	2.4	kW	Total electric power input	P_{elec}	0.007	kW
Cooling capacity (latent)	$P_{rated,c}$	1.2	kW	Sound power level (per speed setting,if applicable)	L_{WA}	-	dB
Heating capacity	$P_{rated,h}$	2.8	kW				
Contact details	Mitsubishi heavy industries thermal systems,LTD						

Model(s) : SAF-DX800E6							
Item	Symbol	Value	Unit	Item	Symbol	Value	Unit
Cooling capacity (sensible)	$P_{rated,c}$	3.7	kW	Total electric power input	P_{elec}	0.007	kW
Cooling capacity (latent)	$P_{rated,c}$	1.9	kW	Sound power level (per speed setting,if applicable)	L_{WA}	-	dB
Heating capacity	$P_{rated,h}$	4.5	kW				
Contact details	Mitsubishi heavy industries thermal systems,LTD						

Model(s) : SAF-DX1000E6							
Item	Symbol	Value	Unit	Item	Symbol	Value	Unit
Cooling capacity (sensible)	$P_{rated,c}$	4.2	kW	Total electric power input	P_{elec}	0.007	kW
Cooling capacity (latent)	$P_{rated,c}$	2.1	kW	Sound power level (per speed setting,if applicable)	L_{WA}	-	dB
Heating capacity	$P_{rated,h}$	5.6	kW				
Contact details	Mitsubishi heavy industries thermal systems,LTD						

VRF INVERTER MULTI-SYSTEM AIR-CONDITIONERS



MITSUBISHI HEAVY INDUSTRIES THERMAL SYSTEMS, LTD.

2-3, Marunouchi 3-chome, Chiyoda-ku, Tokyo, 100-8332, Japan
<http://www.mhi-mth.co.jp/en/>

Because of our policy of continuous improvement, we reserve the right to make changes in all specifications without notice.

© Copyright MITSUBISHI HEAVY INDUSTRIES THERMAL SYSTEMS, LTD.