



DATA BOOK

**INVERTER MULTI-SPLIT SYSTEM
RESIDENTIAL AIR-CONDITIONERS**
(Split system, air to air heat pump type)

(OUTDOOR UNIT)
SCM100ZS-W

(INDOOR UNIT)

Wall mounted type

SRK20ZSX-W,-WB,-WT
25ZSX-W,-WB,-WT
35ZSX-W,-WB,-WT
50ZSX-W,-WB,-WT
60ZSX-W,-WB,-WT

SRK20ZS-W,-WB,-WT
25ZS-W,-WB,-WT
35ZS-W,-WB,-WT
50ZS-W,-WB,-WT

SRK71ZR-W
80ZR-W

SKM20ZSP-W
25ZSP-W
35ZSP-W

Ceiling concealed type

SRR25ZM-W
35ZM-W
25ZS-W
35ZS-W
50ZS-W
60ZS-W

Ceiling suspended type

FDE50VH

Duct connected-Low/Middle static pressure type

FDUM50VH

Floor standing type

SRF25ZS-W
35ZS-W
50ZSX-W

4-way ceiling cassette type

FDTC25VH
35VH
50VH
60VH
FDTC25VH1
35VH1

CONTENTS

1. OUTDOOR UNITS	4
1.1 Specifications	4
1.2 Exterior dimensions	5
1.3 Electrical wiring	6
1.4 Noise level	7
1.5 Application data	9
(1) Installation of outdoor unit	9
(2) Combination limitation of connected indoor units	13
(3) Safety precautions in handling air-conditioners with flammable refrigerant ...	14
(4) Guidance of the connected room	18
2. INDOOR UNITS	21
2.1 Specifications	21
(1) Wall mounted type (SRK, SKM)	21
(2) Floor standing type (SRF)	35
(3) Ceiling concealed type (SRR)	38
(4) 4-way ceiling cassette type (FDTC)	44
(5) Duct connected-Low/Middle static pressure type (FDUM)	50
(6) Ceiling suspended type (FDE)	51
2.2 Exterior dimensions	52
(1) Wall mounted type (SRK, SKM)	52
(2) Floor standing type (SRF)	56
(3) Ceiling concealed type (SRR)	57
(4) 4-way ceiling cassette type (FDTC)	59
(5) Duct connected-Low/Middle static pressure type (FDUM)	61
(6) Ceiling suspended type (FDE)	62
(7) Remote control	63
2.3 Electrical wiring	66
(1) Wall mounted type (SRK, SKM)	66
(2) Floor standing type (SRF)	70
(3) Ceiling concealed type (SRR)	71
(4) 4-way ceiling cassette type (FDTC)	72
(5) Duct connected-Low/Middle static pressure type (FDUM)	73
(6) Ceiling suspended type (FDE)	74

2.4 Noise level	75
(1) Wall mounted type (SRK, SKM)	75
(2) Floor standing type (SRF)	109
(3) Ceiling concealed type (SRR)	117
(4) 4-way ceiling cassette type (FDTC)	155
(5) Duct connected-Low/Middle static pressure type (FDUM)	166
(6) Ceiling suspended type (FDE)	166
2.5 Characteristics of fan	167
2.6 Application data	169
(1) Wall mounted type (SRK, SKM)	169
(2) Floor standing type (SRF)	185
(3) Ceiling concealed type (SRR)	189
(4) 4-way ceiling cassette type (FDTC)	193
(5) Duct connected-Low/Middle static pressure type (FDUM)	201
(6) Ceiling suspended type (FDE)	207
(7) Electric wiring work installation (FDTC, FDUM, FDE)	211
3. PIPING SYSTEM	215
4. RANGE OF USAGE & LIMITATIONS	216
5. TABLE OF INDOOR UNIT COMBINATIONS	217
6. SELECTION CHARTS	225
7. TABLE OF FUNCTIONS CONNECTED WIRED REMOTE CONTROL (RC-E5)	226
8. OPTION PARTS	227
8.1 Wired remote control	227
8.2 Simple wired remote control (RCH-E3)	240
8.3 Wireless kit	246
8.4 Motion sensor kit	274
8.5 Interface kit (SC-BIKN2-E)	294
8.6 Superlink E board (SC-ADNA-E)	298
8.7 Ceiling concealed type (SRR) option parts	300
8.8 OA spacer (FDTC only)	303
8.9 Duct joint (FDTC only)	307
8.10 Filter kit (FDUM only)	308
9. TECHNICAL INFORMATION	310

■ Table of models

Model \ Capacity	20	25	35	50	60	71	80
Wall mounted type (SRK ** ZSX-W, -WB, -WT)	○	○	○	○	○		
Wall mounted type (SRK ** ZS-W, -WB, -WT)	○	○	○	○			
Wall mounted type (SRK ** ZR-W)						○	○
Wall mounted type (SKM** ZSP-W)	○	○	○				
Ceiling concealed type (SRR ** ZS-W)		○	○	○	○		
Ceiling concealed type (SRR ** ZM-W)		○	○				
Floor standing type (SRF ** ZS-W)		○	○				
Floor standing type (SRF ** ZSX-W)				○			
4-way ceiling cassette type (FDTC)		○	○	○	○		
Duct connected-Low/Middle static pressure type (FDUM)				○			
Ceiling suspended type (FDE)				○			
Outdoor unit to be combined (SCM)	SCM100ZS-W						

■ How to read the model name

Outdoor unit

Example: **SCM 100 Z S-W**

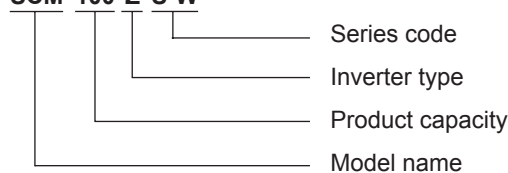

Indoor unit

Example: **SRK 20 Z SX-W**

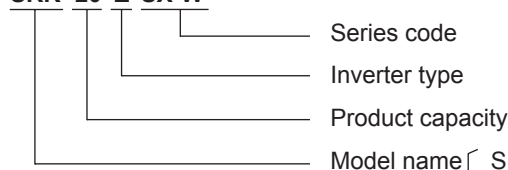

- SRK, SKM : Wall mounted type
- SRR : Ceiling concealed type
- SRF : Floor standing type
- FDTC : 4-way ceiling cassette type
- FDUM : Duct connected-Low/Middle static pressure type
- FDE : Ceiling suspended type

1. OUTDOOR UNITS

1.1 Specifications

Item		Model	SCM100ZS-W			
Cooling capacity (1)		W	10000 (1700 (Min.) - 11500 (Max.))			
Heating capacity (1)		W	10500 (900 (Min.) - 11500 (Max.))			
Heating capacity (H2)		W	—			
Power source			1 Phase, 220 - 240V, 50Hz/ 220V, 60Hz			
Operation data (1)	Power consumption	Cooling	kW	2.70 (0.48-3.65)		
		Heating		2.38 (0.37-2.90)		
		Heating (H2)		—		
	Running current	Cooling	A	12.4 / 11.9 / 11.4 (220/ 230/ 240V)		
		Heating		10.9 / 10.5 / 10.0 (220/ 230/ 240V)		
	Inrush current, max current			5.0 Max. 21		
	EER	Cooling		3.70		
		Heating		4.41		
	COP	Heating (H2)		—		
	Sound power level	Cooling	dB	67		
		Heating		72		
Sound pressure level	Cooling	dB(A)	54			
	Heating		59			
Silent mode	Cooling		49			
	Heating		50			
Exterior dimensions (Height x Width x Depth)		mm	945 x 970 x 370			
Exterior appearance (Munsell color)			Stucco white (4.2Y 7.5/1.1) near equivalent			
Net weight		kg	73			
Refrigerant equipment	Compressor type & Q'ty			RMT5118SBP2 (Twin rotary type) x 1		
	Motor (Starting method)		kW	1.4 (Line starting)		
	Refrigerant oil		L	0.675 (DIAMOND FREEZE MB75)		
	Refrigerant (4)		kg	R32 2.98 (Pre-Charged up to the piping length of 40m)		
	Heat exchanger			M fins & inner grooved tubing		
	Refrigerant control			Capillary tubes + Electronic expansion valve		
	Device control			Microcomputer control		
Air handling equipment	Fan type & Q'ty			Propeller fan x 1		
	Motor		W	86		
	Air flow	Cooling	m ³ /min	75.0		
Heating		75.0				
Shock & vibration absorber			Cushion rubber (for compressor)			
Electric heater			—			
Safety devices			Compressor overheat protection, Overcurrent protection, Frost protection, Serial signal error protection, Outdoor fan motor error protection, Heating & Cooling overload protection			
Installation data	Refrigerant piping size (O.D)		mm	Liquid line: ϕ 6.35 (1/4") x 5 Gas line: ϕ 9.52 (3/8") x 5		
	Connecting method			Flare connecting		
	Insulation for piping			Necessary (Both sides), independent		
	Length for one indoor unit		m	Max. 25		
	Total length for all rooms			Max. 75		
	Vertical height difference between outdoor unit and indoor unit			Max. 20 (Outdoor unit is higher) Max. 20 (Outdoor unit is lower)		
Height difference of the indoor units		Max. 25				
Recommended breaker size		A	25			
Connection wiring	Size x Core number		1.5mm ² x 4 cores (Including earth cable)			
	Connecting method		Terminal block (Screw fixing type)			
IP number			IPX4			
Accessories (included)			Installation sheet, Elbow, Grommet			
Indoor unit to be combined			SRK20,25,35,50,60ZSX-W(-WB,-WT) SRK20,25,35,50ZS-W(-WB,-WT) SKM20,25,35ZSP-W, SRK71,80ZR-W SRR25,35ZM-W, SRR25,35,50,60ZS-W, SRF25,35ZS-W, SRF50ZSX-W FDTC25,35,50,60VH, FDTC25, 35VH1, FDE50VH, FDUM50VH			
Number of connectable indoor units			Min. 2 - Max. 5			
Total of indoor units		kW	9.0 - 16.0			
Notes (1) The data are measured at the following conditions. The pipe length for one indoor unit is 5m.						
Operation	Item	Indoor air temperature		Outdoor air temperature		Standards
		DB	WB	DB	WB	
	Cooling	27°C	19°C	35°C	24°C	ISO15042-T1
	Heating	20°C	—	7°C	6°C	ISO15042-H1
Heating (H2)	20°C	—	2°C	1°C	ISO15042-H2	
(2) This air-conditioner is manufactured and tested in conformity with the ISO.						
(3) The operation data are applied to the 220/230/240V districts respectively.						
(4) The refrigerant quantity to be charged includes the refrigerant in 40m connecting piping. (Purging is not required even for the short piping.)						

RWC000Z342

1.2 Exterior dimensions Model SCM100ZS-W

Symbol	Content
A	Service valve connection (gas side) φ9.52(3/8") (Flare)
B	Service valve connection (liquid side) φ6.35(1/4") (Flare)
C	Pipe/cable draw-out hole
D	Drain discharge hole φ20 × 3places
E	Anchor bolt hole M10-12 × 4places

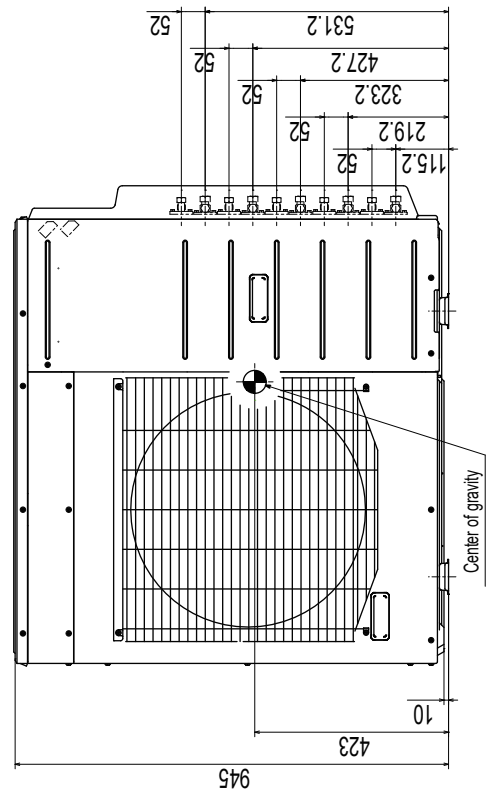
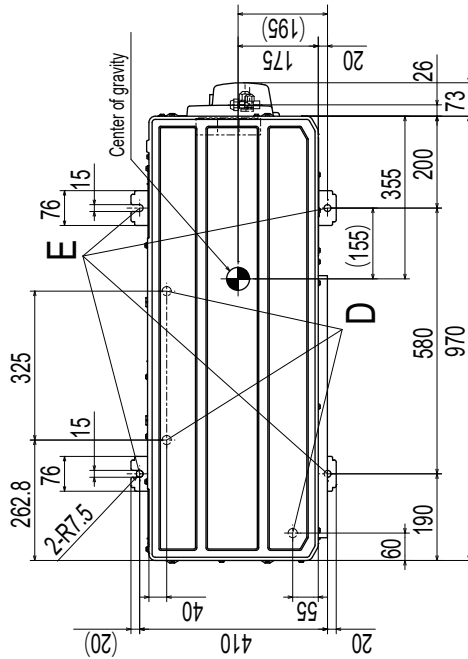

Notes

- (1) It must not be surrounded by walls on four sides.
- (2) The unit must be fixed with anchor bolts.
An anchor bolt must not protrude more than 15mm.
- (3) Where the unit is subjected to strong winds, lay it in such a direction that the blower outlet faces perpendicularly to the dominant wind direction.
- (4) Leave 1.2m or more space above the unit.
- (5) A wall in front of the blower outlet must not exceed the unit's height.

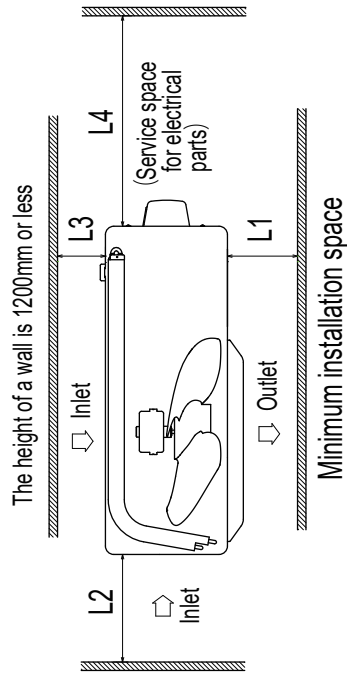

Examples of installation Dimensions	I		II		III	
	Open	300	Open	5	Open	500
L1	300	150	300	150	300	150
L2	300	150	300	150	300	150
L3	300	150	300	150	300	150
L4	250	250	250	250	250	250

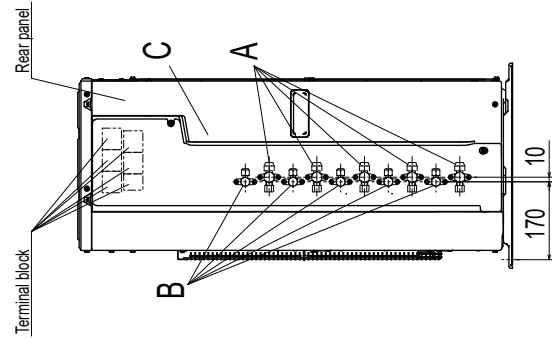

Unit:mm

1.3 Electrical wiring Model SCM100ZS-W

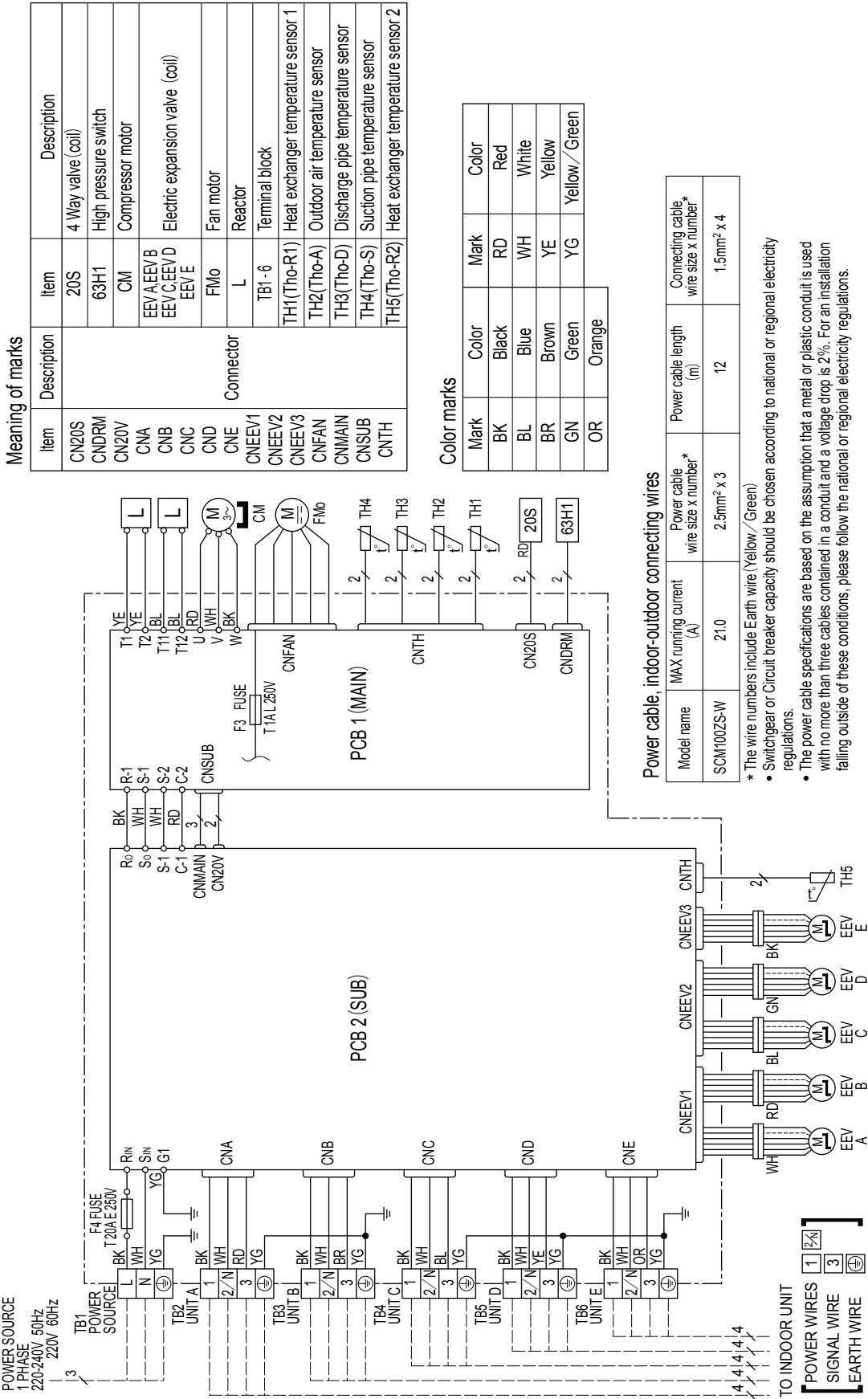

Meaning of marks

Item	Description	Item	Description
CN20S	Connector	20S	4 Way valve (coil)
CN20V		63H1	High pressure switch
CNA		CM	Compressor motor
CNB	Connector	EEV A, EEV B	Electric expansion valve (coil)
CNC		EEV C, EEV D	
CNE		EEV E	
CND		FMo	Fan motor
CNE		L	Reactor
CNEEV1	Terminal block	TB1-6	Terminal block
CNEEV2		TH1(Tho-R1)	Heat exchanger temperature sensor 1
CNEEV3		TH2(Tho-A)	Outdoor air temperature sensor
CNFAN		TH3(Tho-D)	Discharge pipe temperature sensor
CNMAIN		TH4(Tho-S)	Suction pipe temperature sensor
CNSUB	Terminal block	TH5(Tho-R2)	Heat exchanger temperature sensor 2
CNTH			

Color marks

Mark	Color	Mark	Color
BK	Black	RD	Red
BL	Blue	WH	White
BR	Brown	YE	Yellow
GN	Green	YG	Yellow / Green
OR	Orange		

Power cable, indoor-outdoor connecting wires

Model name	MAX running current (A)	Power cable wire size x number*	Power cable length (m)	Connecting cable, wire size x number*
SCM100ZS-W	21.0	2.5mm ² x 3	12	1.5mm ² x 4

- * The wire numbers include Earth wire (Yellow / Green)
- Switchgear or Circuit breaker capacity should be chosen according to national or regional electricity regulations.
- The power cable specifications are based on the assumption that a metal or plastic conduit is used with no more than three cables contained in a conduit and a voltage drop is 2%. For an installation falling outside of these conditions, please follow the national or regional electricity regulations.

RWC000Z344

1.4 Noise level

(1) Sound power level

Model SCM100ZS-W

Noise Level	Cooling	67 dB(A)
	Heating	72 dB(A)

Condition	ISO15042 T1/H1
Mode	Rated capacity value

x Cooling, ○ — Heating

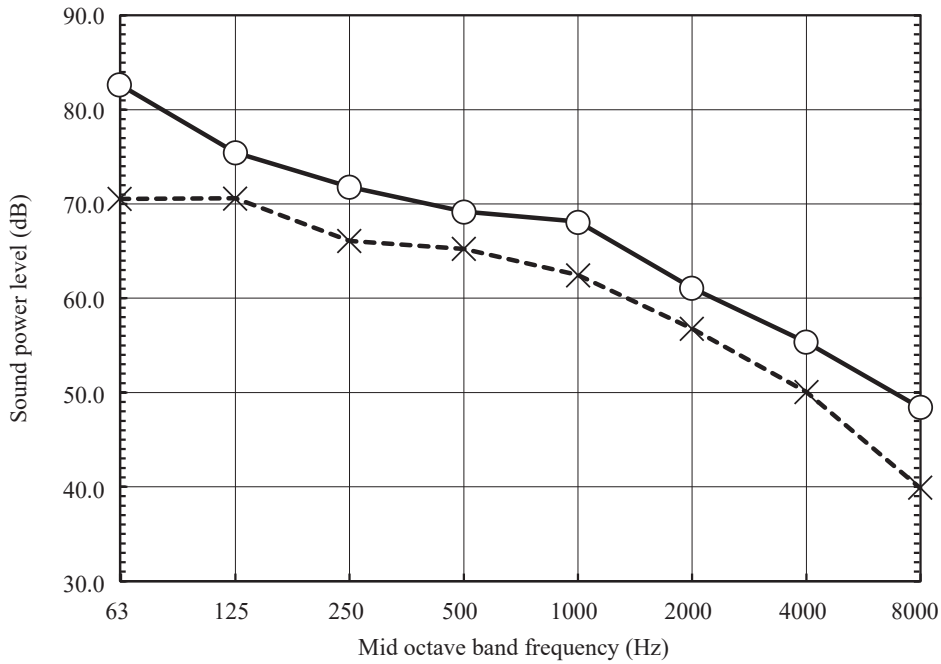

(2) Sound pressure level

(a) Rated capacity value

Model SCM100ZS-W

Noise Level	Cooling	54 dB(A)
	Heating	59 dB(A)

Condition	ISO15042 T1/H1
Mode	Rated capacity value

x Cooling, ○ — Heating

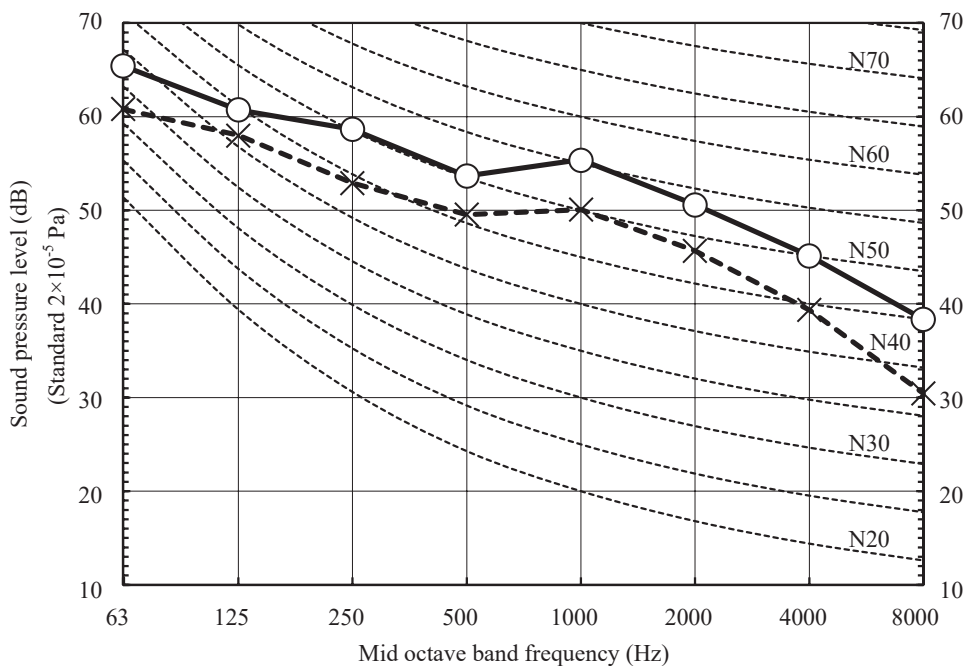

(b) Silent mode

Model SCM100ZS-W

Noise Level	Cooling	49 dB(A)
	Heating	50 dB(A)

Condition	ISO15042 T1/H1
Mode	Silent

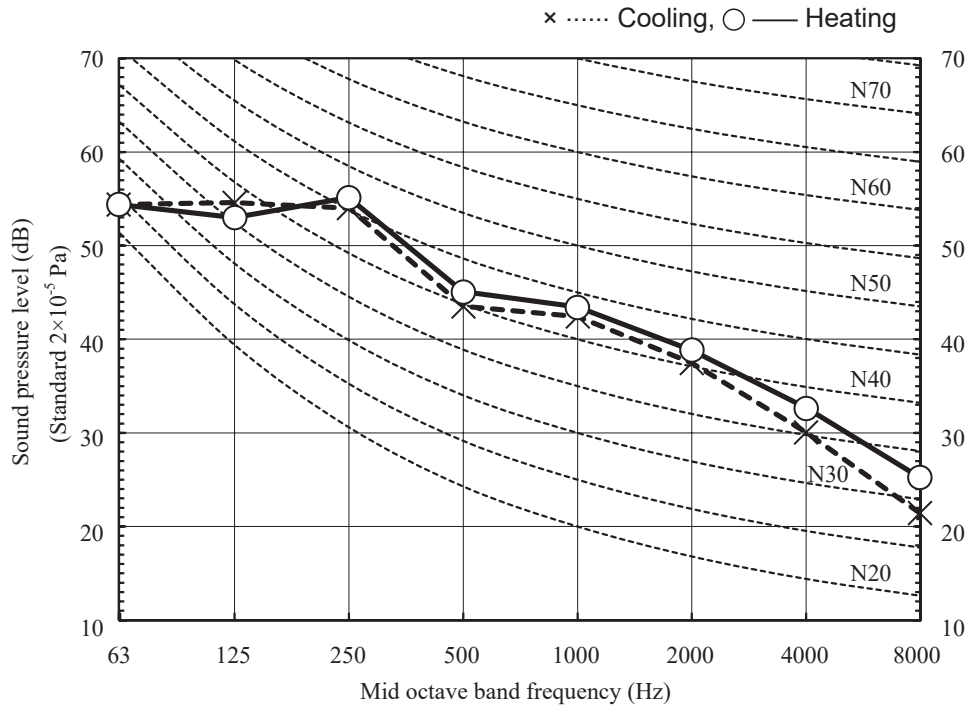

1.5 Application data

(1) Installation of outdoor unit

RSA012A926
Model SCM100ZS-W
R32 REFRIGERANT USED

• This installation manual deals with an outdoor unit installation only. For an indoor unit installation, refer to the indoor unit installation manual supplied with the indoor unit.

NOTE

- * This model requires normally a minimum of 3 indoor units.
- * This model requires a minimum of 2 indoor units in case of combinations shown on the right.

	Indoor unit combination		Indoor unit combination		Indoor unit combination
I	Include in SRK71/80ZR(A)-W	III	SRK-ZSX(A)-W × 1 and FDE × 1	V	FDE × 1 and SRF35/50
II	SRK-ZSX(A)-W × 2	IV	SRK-ZSX(A)-W × 1 and SRF35/50		

SAFETY PRECAUTIONS

- Before installation, read the "SAFETY PRECAUTIONS" carefully and strictly follow it during the installation work in order to protect yourself.
 - The precautionary items mentioned below are distinguished into two levels, **⚠ WARNING** and **⚠ CAUTION**.
 - **⚠ WARNING** Indicates a potentially hazardous situation which, if not avoided, can result in serious consequences such as death or severe injury.
 - **⚠ CAUTION** Indicates a potentially hazardous situation which, if not avoided, can result in personal injury or property damage.
- Both mention the important items to protect your health and safety. Therefore, strictly follow them by any means.



⚠ WARNING

- **Be sure to use only for residential purpose.**
If this unit is installed in inferior environment such as machine shop, vehicle (like ship), warehouse, etc., it can malfunction.
- **Installation must be carried out by the qualified installer completely in accordance with the installation manual.**
Installation by non qualified person or incorrect installation can cause serious troubles such as water leak, electric shock, fire and personal injury.
- **Be sure to wear protective goggles and gloves while performing installation work.**
Improper safety measures can result in personal injury.
- **Use the original accessories and the specified components for the installation.**
Using parts other than those prescribed may cause water leak, electric shock, fire and personal injury.
- **Do not install the unit near the location where leakage of flammable gases can occur.**
If leaked gases accumulate around the unit, it can cause fire resulting in property damage and personal injury.
- **When installing the unit in small rooms, make sure that refrigerant density does not exceed the limit (Reference: ISO5149) in the event of leakage.**
If refrigerant density exceeds the limit, consult the dealer and install the ventilation system. Otherwise lack of oxygen can occur resulting in serious accident.
- **Install the unit in a location where unit will remain stable, horizontal and free of any vibration transmission.**
Unsuitable installation location can cause the unit to fall resulting in material damage and personal injury.
- **Do not run the unit with removed panels or protections.**
Touching rotating equipments, hot surfaces or high voltage parts can cause personal injury due to entrapment, burn or electric shock.
- **This unit is designed specifically for R32.**
Using any other refrigerant can cause unit failure and personal injury.
- **Do not vent R32 into atmosphere.**
R32 is a fluorinated greenhouse gas with a Global Warning Potential (GWP) = 675.
- **Make sure that no air enters the refrigerant circuit when the unit is installed and removed.**
If air enters the refrigerant circuit, the pressure in the refrigerant circuit will become too high, which can cause burst and personal injury.
- **Be sure to use the prescribed pipes, flare nuts and tools for R32 or R410A.**
Using existing parts (for R22 or R407C) can cause refrigerant circuit burst resulting in unit failure and personal injury.
- **Be sure to connect both liquid and gas connecting pipes properly before operating the compressor.**
Do not open the liquid and gas operation valves before completing piping work, and evacuation.
If the compressor is operated when connecting pipes are not connected and operation valves are open, air can be sucked into the refrigerant circuit which can cause anomalous high pressure resulting in burst or personal injury.
- **Be sure to tighten the flare nuts to specified torque using the torque wrench.**
Tightening flare nuts with excess torque can cause burst and refrigerant leakage after a long period.
- **During pump down work, be sure to stop the compressor before closing operation valves and removing connecting pipes.**
If the connecting pipes are removed when the compressor is in operation and operation valves are open, air can be sucked into the refrigerant circuit which can cause anomalous high pressure resulting in burst or personal injury.
- **In the event of refrigerant leakage during installation, be sure to ventilate the working area properly.**
If the refrigerant comes into contact with naked flames, poisonous gases will be produced.
- **Electrical work must be carried out by the qualified electrician, strictly in accordance with national or regional electricity regulations.**
Incorrect installation can cause electric shock, fire or personal injury.
- **Make sure that earth leakage breaker and circuit breaker of appropriate capacities are installed.**
Circuit breaker should be able to disconnect all poles under over current. Absence of appropriate breakers can cause electric shock, personal injury or property damage.
- **Be sure to switch off the power source in the event of installation, maintenance or service.**
If the power source is not switched off, there is a risk of electric shock, unit failure or personal injury.
- **Be sure to tighten the cables securely in terminal block and relieve the cables properly to prevent overloading the terminal blocks.**
Loose connections or cable mountings can cause anomalous heat production or fire.
- **Do not process, splice or modify the power cable, or share the socket with other power plugs.**
Improper power cable or power plug can cause fire or electric shock due to poor connection, insufficient insulation or over-current.
- **Do not perform any change in protective device or its setup condition yourself.**
Changing protective device specifications can cause electric shock, fire or burst.
- **Be sure to clamp the cables properly so that they do not touch any internal component of the unit.**
If cables touch any internal component, it can cause overheating and fire.
- **Be sure to install service cover properly.**
Improper installation can cause electric shock or fire due to intrusion of dust or water.
- **Be sure to use the prescribed power and connecting cables for electrical work.**
Using improper cables can cause electric leak or fire.
- **This appliance must be connected to main power source by means of a circuit breaker or switch with a contact separation of at least 3 mm.**
Improper electrical work can cause unit failure or personal injury.
- **Be sure to connect the power source cable with power source properly.**
Improper connection can cause intrusion of dust or water resulting in electric shock or fire.

⚠ CAUTION

- **Take care when carrying the unit by hand.**
If the unit weight is more than 20 kg, it must be carried by two or more persons. Do not carry the unit by the plastic straps. Always use the carry handle.
- **Do not install the outdoor unit in a location where insects and small animals can inhabit.**
Insects and small animals can enter the electrical parts and cause damage resulting in fire or personal injury. Instruct the user to keep the surroundings clean.
- **If the outdoor unit is installed at height, make sure that there is enough space for installation, maintenance and service.**
Insufficient space can result in personal injury due to falling from the height.
- **Do not install the unit near the location where neighbours are bothered by noise or air generating from the unit.**
It can affect surrounding environment and cause a claim.
- **Do not install in the locations where unit is directly exposed to corrosive gases (like sulphide gas, chloride gas), sea breeze or salty atmosphere.**
It can cause corrosion of heat exchanger and damage to plastic parts.
- **Do not install the unit close to the equipments that generate electromagnetic waves and/or high-harmonic waves.**
Equipment such as inverters, standby generators, medical high frequency equipments and telecommunication equipments can affect the system, and cause malfunctions and breakdowns. The system can also affect medical equipment and telecommunication equipment, and obstruct its function or cause jamming.
- **Do not install the unit in the locations where:**
 - There are heat sources nearby.
 - Unit is directly exposed to rain or sunlight.
 - There is any obstacle which can prevent smooth air circulation from inlet and outlet side of the unit.
 - Unit is directly exposed to oil mist and steam such as kitchen.
 - Chemical substances like ammonia (organic fertilizer), calcium chloride (snow melting agent) and acid (sulfurous acid etc.), which can harm the unit, will generate or accumulate.
 - Drain water can not be discharged properly.
 - TV set or radio receiver is placed within 1 m.
 - Height above sea level is more than 1000 m.
- **Dispose of all packing materials properly.**
Packing materials contain nails and wood which can cause personal injury. Keep the polybag away from children to avoid the risk of suffocation.
- **Do not put anything on the outdoor unit.**
Object may fall causing property damage or personal injury.
- **Do not touch the aluminum fin of the outdoor unit.**
Aluminium fin temperature is high during heating operation. Touching fin can cause burn.
- **Do not touch any refrigerant pipe with your hands when the system is in operation.**
During operation the refrigerant pipes become extremely hot or extremely cold depending on the operating condition. Touching pipes can cause personal injury like burn (hot/cold).
- **Install isolator or disconnect switch on the power source wiring in accordance with the local codes and regulations.**
The isolator should be locked in OFF state in accordance with EN60204-1.

1. ACCESSORIES AND TOOLS

Standard accessories (Supplied with outdoor unit)		Q'ty	Locally procured parts		Tools for installation work		
(1)	Drain grommet 	2	(a) Anchor bolt (M10-M12) × 4 pcs.	Plus headed driver	Spanner wrench	Vacuum pump*	
(2)	Drain elbow 	1	(b) Putty	Knife	Torque wrench [14.0-82.0 N·m(1.4-8.2 kgf·m)]	Gauge manifold *	
(3)	Variable diameter joint ø9.52→ø12.7	3	(c) Electrical tape	Saw	Wrench key (Hexagon) [4 mm]	Charge hose *	
(4)	Variable diameter joint ø9.52→ø15.88	2	(d) Connecting pipe	Tape measure	Flaring tool set *	Vacuum pump adapter* (Anti-reverse flow type)	
			(e) Connecting cable	Pipe cutter	Flare adjustment gauge	Gas leak detector *	
			(f) Power cable				
			(g) Clamp and screw (for finishing work)				

*Designed specifically for R32 or R410A

2. OUTDOOR UNIT INSTALLATION

Note as a unit designed for R32

- Do not use any refrigerant other than R32. R32 will rise to pressure about 1.6 times higher than that of a conventional refrigerant. A cylinder containing R32 has a light blue indication mark on the top.
- Do not use a charge cylinder. The use of a charge cylinder will cause the refrigerant composition to change, which results in performance degradation.
- In charging refrigerant, always take it out from a cylinder in the liquid phase.
- All indoor units must be models designed exclusively for R32. Check connectable indoor unit models in a catalog, etc. (A wrong indoor unit, if connected into the system, will impair proper system operation)

1. Haulage

- Always carry or move the unit with two or more persons.
- The right hand side of the unit as viewed from the front (outlet side) is heavier. A person carrying the right hand side must take care of this fact. A person carrying the left hand side must hold the handle provided on the panels of the unit with his right hand and the corner column section of the unit with his left hand.
- In the case of hoisting the unit, use nylon slings or ropes and protection pads for prevent damage of the unit.

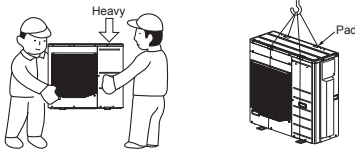

CAUTION

When a unit is hauled, take care of its gravity center position which is shifted towards right hand side. If the unit is not hauled properly, it can go off balance and fall resulting in serious injury.

2. Selecting the installation location

Select the suitable installation location where:

- Unit will be stable, horizontal and free of any vibration transmission.
- There is no obstacle which can prevent smooth air circulation from inlet and outlet side of the unit.
- There is enough space for service and maintenance of unit.
- Neighbours are not bothered by noise or air generating from the unit.
- Outlet air of the unit does not blow directly to animals or plants.
- Drain water can be discharged properly.
- There is no risk of flammable gas leakage.
- There are no other heat sources nearby.
- Unit is not directly exposed to rain or sunlight.
- Unit is not directly exposed to oil mist and steam.
- Chemical substances like ammonia (organic fertilizer), calcium chloride (snow melting agent) and acid (sulfurous acid etc.), which can harm the unit, will not generate or accumulate.
- Unit is not directly exposed to corrosive gases (like sulphide gas, chloride gas), sea breeze or salty atmosphere.
- No TV set or radio receiver is placed within 1 m.
- Unit is not affected by electromagnetic waves and/or high-harmonic waves generated by other equipments.
- Strong wind does not blow against the unit outlet.
- Heavy snowfalls do not occur (If installed, provide proper protection to avoid snow accumulation).

NOTE

If the unit is installed in the area where there is a possibility of strong wind or snow accumulation, the following measures are required.

(1) Location of strong wind

- Place the unit with its outlet side facing the wall.
- Place the unit such that the direction of air from the outlet gets perpendicular to the wind direction.



(2) Location of snow accumulation

- Install the unit on the base so that the bottom is higher than snow cover surface.
- Install the unit under eaves or provide the roof on site.

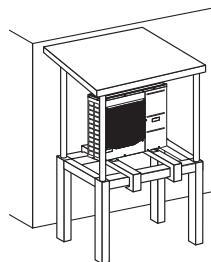

3. Installation space

- There must be 1m or larger space between the unit and the wall in at least 1 of the 4 sides. Walls surrounding the unit from 4 sides is not acceptable. Refer to the following figure and table for details.

Examples of installation Dimensions	(mm)		
	I	II	III
L1	Open	Open	500
L2	300	5	Open
L3	150	300	150

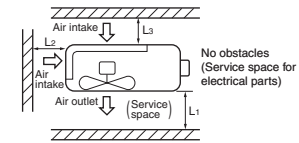

NOTE

When more than one unit are installed side by side, provide a 250mm or wider interval between them as a service space.

CAUTION

When more than one unit are installed in parallel directions, provide sufficient inlet space so that short-circuiting may not occur.

4. Drain piping work (If necessary)

Carry out drain piping work by using a drain elbow and a drain grommet supplied separately as accessories if condensed water needs to be drained out.

- Install drain elbow and drain grommet.
- Seal around the drain elbow and drain grommet with putty or adequate caulking material.

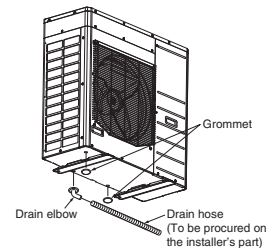

CAUTION

Do not use drain elbow and drain grommet if there is a possibility to have several consecutive days of sub zero temperature. (There is a risk of drain water freezing inside and blocking the drain.)

5. Installation

- Install the unit on a flat level base.
- While installing the unit, keep space and fix the unit's legs with 4 anchor bolts as shown in the figure below. The protrusion of an anchor bolt from the foundation surface must be kept within 15mm.

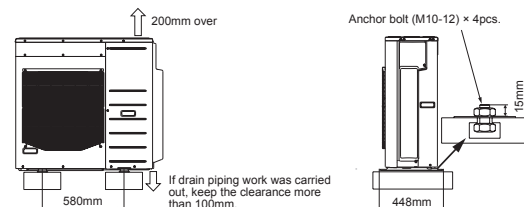

• Notabilia for installation

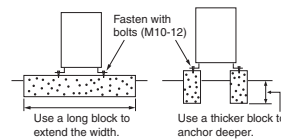

CAUTION

- Install the unit properly so that it does not fall over during earthquake, strong wind, etc.
- Make sure that unit is installed on a flat level base. Installing unit on uneven base may result in unit malfunction.

3. PREPARATION FOR WORK

1. Removing service cover

Remove the screw. Slide service cover downwards and remove it.

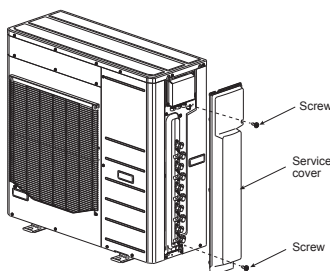

NOTE

Variable diameter joint is on service cover. Remove it at a safe place before carrying in the installation location to prevent unexpected fall of parts.

2. Removing terminal cover

Remove the screw and take out terminal cover.

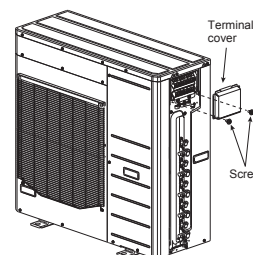

4. CONNECTING PIPING WORK

1. Restrictions on unit installation

Abide by the following restrictions on unit installation. Improper installation can cause compressor failure or performance degradation.

Piping length	One indoor unit All indoor unit	MAX 25 m MAX 75 m
Height difference		
Length of chargeless refrigerant pipe	40 m	

2. Preparation of connecting pipe

2.1 Selecting connecting pipe

Select connecting pipe according to the following table.

Indoor unit	Model 20/25/35	Model 40/50/60	Model 71/80
Gas pipe	φ 9.52	φ 12.7	φ 15.88
Liquid pipe	φ 6.35	φ 6.35	φ 6.35

- Pipe wall thickness must be greater than or equal to 0.8 mm (φ 15.88 : 1.0 mm).
- Pipe material must be O-type (Phosphorus deoxidized seamless copper pipe ICS 23.040.15, ICS 77.150.30).

2.2 Cutting connecting pipe

- (1) Cut the connecting pipe to the required length with pipe cutter.
- (2) Hold the pipe downward and remove the burrs. Make sure that no foreign material enters the pipe.
- (3) Cover the connecting pipe ends with the tape.

3. Piping work

Check that both liquid and gas service valves are fully closed. Carry out the piping work with service valves fully closed.

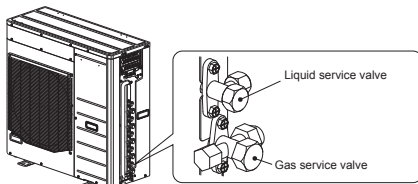

3.1 Flaring pipe

- (1) Take out flare nuts from the service valves of outdoor unit. If 4.0, 5.0, 6.0 kW class indoor unit (gas side pipe φ 12.7) or 7.1, 8.0 kW class indoor unit (gas side pipe φ 15.88) is going to be connected to the service valves (φ 9.52), variable joints available as accessories must be applied to the gas side service valves. Securely fit the copper packing between the service valve and the variable diameter joint to prevent shifting. Engage flare nuts onto connecting pipes.

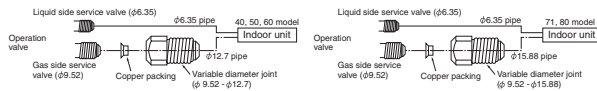

- (2) Flare the pipes according to table and figure shown below. Flare dimensions for R32 are different from those for conventional refrigerant. Although it is recommended to use the flaring tools designed specifically for R32, conventional flaring tools can also be used by adjusting the dimension B with a flare adjustment gauge.

Copper pipe outer diameter	A	B [Rigid (clutch) type]	
		R32 or R410A	Conventional
φ 6.35	9.1		
φ 9.52	13.2		
φ 12.7	16.6		
φ 15.88	19.7		
		φ 6.35	0-0.5
		φ 9.52	1.0-1.5
		φ 2.7	
		φ 15.88	

3.2 Connecting pipes

- (1) Connect pipes on both liquid and gas sides.

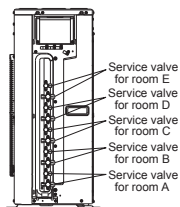

- (2) Tighten nuts to specified torque shown in the table below.

Service valve size (mm)	Tightening torque (N·m)
φ 6.35 (1/4")	14-18
φ 9.52 (3/8")	34-42
φ 12.7 (1/2")	49-61
φ 15.88 (5/8")	68-82

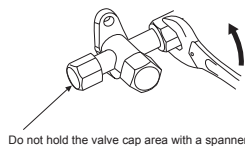

CAUTION

- Do not apply refrigerating machine oil to the flared surface. It can cause refrigerant leakage.
- Do not apply excess torque to the flared nuts. The flared nuts may crack resulting in refrigerant leakage.

4. Evacuation

- (1) Connect vacuum pump to gauge manifold. Connect charge hose of gauge manifold to a service port of outdoor unit.
- (2) Fully open the handle Lo for the manifold, run the vacuum pump for at least one hour after the vacuum gauge shows -0.1 MPa (-76 cm Hg).
- (3) Confirm that the vacuum gauge indicator does not rise even if the system is left for 15 minutes or more. Vacuum gauge indicator will rise if the system has moisture left inside or has a leakage point. Check the system for the leakage point. If leakage point is found, repair it and return to (1) again.
- (4) Close the Handle Lo and stop the vacuum pump. Keep this state for a few minutes to make sure that the compound pressure gauge pointer does not swing back.
- (5) Remove valve caps from liquid service valve and gas service valve.
- (6) Turn the liquid service valve's rod 90 degree counterclockwise with a hexagonal wrench key to open valve. Close it after 5 seconds, and check for gas leakage. Using soapy water, check for gas leakage from indoor unit's flare and outdoor unit's flare and valve rods. Wipe off all the water after completing the check.
- (7) Disconnect charging hose from gas service valve's service port and fully open liquid and gas service valves. (Do not attempt to turn valve rod beyond its stop.)
- (8) Tighten service valve caps and service port cap to the specified torque shown in the table below.

Service valve size (mm)	Service valve cap tightening torque (N·m)	Service port cap tightening torque (N·m)
φ 6.35 (1/4")	20-30	10-12
φ 9.52 (3/8")		
φ 12.7 (1/2")	25-35	
φ 15.88 (5/8")	30-40	

- (9) Repeat the above steps (1) to (8) for all connected indoor units.

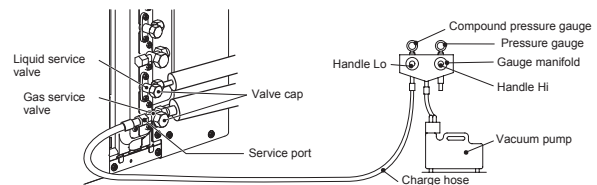

CAUTION

To prevent vacuum pump oil from entering into the refrigerant system, use a counterflow prevention adapter.

5. Additional refrigerant charge

Additional refrigerant charge is required only when connecting pipe length exceeds 40m.

5.1 Calculating additional refrigerant charge

Additional refrigerant charge can be calculated using the formula given below.
Additional refrigerant charge (g) = { Connecting pipe length (m) - Factory charged length 40 (m) } x 20 (g/m)

NOTE

- If additional refrigerant charge calculation result is negative, there is no need to remove the refrigerant.
- If refrigerant recharge is required for the unit with connecting pipe length 40m or shorter, charge the factory charged amount as shown in the table below.

	Model SCM100
The factory refrigerant charge amount (kg)	2.98
The maximum refrigerant charge amount (kg)	3.68

5.2 Charging refrigerant

- (1) Charge the R32 refrigerant in liquid phase from service port with both liquid and gas service valves shut. Since R32 refrigerant must be charged in the liquid phase, make sure that refrigerant is discharged from the cylinder in the liquid phase all the time.
- (2) When it is difficult to charge a required refrigerant amount, fully open both liquid and gas service valves and charge refrigerant, while running the unit in the cooling mode. When refrigerant is charged with the unit being run, complete the charge operation within 30 minutes.
- (3) Write the additional refrigerant charge calculated from the connecting pipe length on the label attached on the service cover.

CAUTION

- Running the unit with an insufficient quantity of refrigerant for a long time can cause unit malfunction.
- Do not charge more than the maximum refrigerant amount. It can cause unit malfunction.

5. ELECTRICAL WIRING WORK

⚠ WARNING

- Make sure that all the electrical work is carried out in accordance with the national or regional electrical standards.
- Make sure that the earth leakage breaker and circuit breaker of appropriate capacities are installed (Refer to the table given below).
- Do not turn on the power until the electrical work is completed.
- Do not use a condensive capacitor for power factor improvement under any circumstances. (It does not improve power factor. Moreover, it can cause an abnormal overheat accident).

Breaker specifications

Model	Phase	Earth leakage breaker	Circuit breaker
SCM100	Single phase	Leakage current: 30mA, 0.1 sec. or less	Over current: 25A

Main fuse specification

Model	Specification	Parts No.	Code on LABEL, WIRING
SCM100	250V 20A	SSA564A136A	F4

1. Preparing cable

(1) Selecting cable

Select the power source cable and connecting cable in accordance with the specifications mentioned below.

(a) Power source cable

- 3 cores* 2.5mm² or more, conformed with 60245 IEC57
- When selecting the power source cable length, make sure that voltage drop is less than 2%. If the wire length gets longer, increase the wire diameter.

(b) Connecting cable

- 4 cores* 1.5mm² conformed with 60245 IEC57
- * 1 Earth wire is included (Yellow/Green).

(2) Arrange each wire length as shown below.

Make sure that each wire is stripped 10mm from the end.

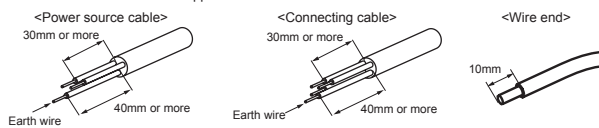

(3) Attach round crimp-type terminal to each wire as shown in the below.

Select the size of round crimp-type terminal after considering the specifications of terminal block and wire diameter.

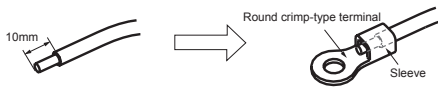

⚠ CAUTION

Power source cable and connecting cable must conform to the specifications mentioned in the manual. Using cables with wrong specifications may result in unit malfunction.

2. Connecting cable

(1) Remove the service cover and the terminal cover.

(2) Connect the cables according to the instructions and figures given below.

(a) Connect the earth wire of power source cable.

An earth wire must be connected before connecting the other wires of power source cable. Keep the earth wire longer than the remaining two wires of power source cable.

(b) Connect the remaining two wires (N and L) of power source cable.

(c) Connect the wires of connecting cables. Make sure that for each wire, outdoor and indoor side terminal numbers match. Terminal number A of the outdoor unit is used for A indoor unit and terminal number B for B indoor unit respectively.

Earth wire shall be Yellow/Green (Y/G) in color and longer than other wires for safety reason.

(3) Fasten the cables properly with cable clamps so that no external force may work on terminal connections.

Moreover, make sure that cables do not touch the piping, etc. When cables are connected, make sure that all electrical components within the electrical component box are free of loose connector coupling or terminal connection.

<Circuit diagram>

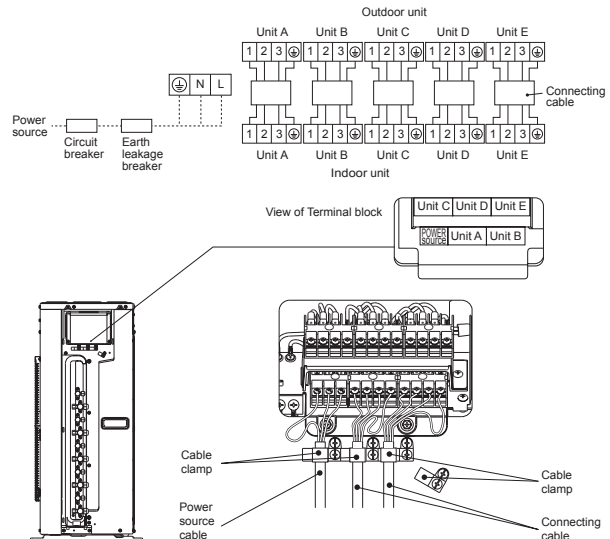

6. FINISHING WORK

NOTE

- Make sure to match the piping and wiring from each unit to the outdoor unit.
- Be careful because if connections are wrong, normal operation cannot be achieved and may damage the compressor.

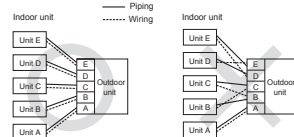

1. Heating and condensation prevention

(1) Dress the connecting pipes (both liquid and gas pipes) with insulation to prevent it from heating and dew condensation.

Use the heat insulating material which can withstand 120°C or higher temperature. Make sure that insulation is wrapped tightly around the pipes and no gap is left between them.

(2) Wrap the refrigerant pipings of indoor unit with indoor unit heat insulation using tape.

(3) Cover the flare-connected joints (indoor side) with the indoor unit heat insulation and wrap it with an insulation pad (standard accessory provided with indoor unit).

(4) Wrap the connecting pipes, connecting cable and drain hose with the tape.

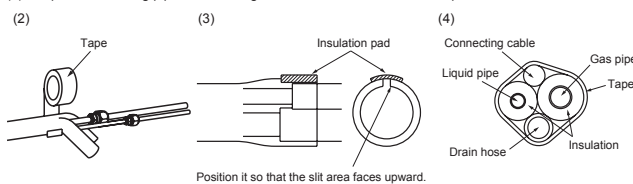

NOTE

Locations where relative humidity exceeds 70%, both liquid and gas pipes need to be dressed with 20mm or thicker heat insulation materials.

⚠ CAUTION

- Improper insulation can cause condensate (water) formation during cooling operation. Condensate can leak or drip causing damage to household property.
- Poor heat insulating capacity can cause pipe outer surface to reach high temperature during heating operation. It can cause cable deterioration and personal injury.

2. Finishing work

(1) Make sure that the exterior portion of connecting pipes, connecting cable and drain hose is wrapped properly with tape. Shape the connecting pipes to match with the contours of the pipe assembly route.

(2) Fix the pipe assembly with the wall using clamps and screws. Pipe assembly should be anchored every 1.5m or less to isolate the vibration.

(3) Install the terminal cover and the service cover securely. Water may enter the unit if service cover is not installed properly, resulting in unit malfunction and failure.

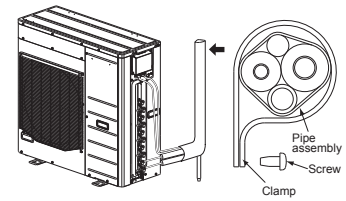

⚠ CAUTION

Make sure that the connecting pipes do not touch the components within the unit. If pipes touch the internal components, it may generate abnormal sounds and/or vibrations.

7. PUMP DOWN

(1) Connect charge hose of gauge manifold to a service port of outdoor unit.

(2) Close the liquid operation valves for all connected indoor units with hexagonal wrench key.

(3) Fully open the gas operation valves with hexagonal wrench key.

(4) Carry out forced cooling operation for all connected indoor units (For forced cooling operation procedure, refer to indoor unit installation manual).

(5) When the low pressure gauge becomes 0.01MPa, close the gas operation valves and stop forced cooling operation.

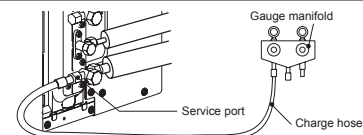

8. INSTALLATION TEST CHECK POINTS

After finishing the installation work, check the following points again before turning on the power. Conduct test run (Refer to indoor unit installation manual) and ensure that the unit operates properly.

Power source voltage complies with the rated voltage of air-conditioner.	
Earth leakage breaker and circuit breaker are installed.	
Power cable and connecting cable are securely fixed to the terminal block.	
Both liquid and gas service valves are fully open.	
No gas leaks from the joints of the operation valves.	

Indoor and outdoor side pipe joints have been insulated.	
Drain hose (if installed) is fixed properly.	
Screw of the service cover is tightened properly.	
Piping and wiring from each unit to the outdoor unit are matched.	

(2) Combination limitation of connected indoor units

Combination limitation of connected indoor units	Number of connected indoor units	Detail of combination limitation									
	2 indoor units	Only the following combinations are possible. <ul style="list-style-type: none"> • Includes 1 or more SRK-ZR • SRK-ZSX x 2 • SRK-ZSX + FDE50 • SRK-ZSX + SRF35,50 • FDE50 + SRF50 									
	3 indoor units	No limitation									
	4 indoor units	No limitation									
	5 indoor units	Only the following A and B combinations are possible. <p>A. The total number of (SRK-ZSX, SRF 35, 50, FDE 50) is 4 or less. 5 units can be connected by connecting other indoor units. Example: ZSX x 4 + ZS x 1 are possible.</p> <p>B. When connecting 146 - 160, the following combinations are not applicable.</p> <table border="1" style="margin-left: 40px;"> <thead> <tr> <th>Indoor units combination</th> <th>Total</th> </tr> </thead> <tbody> <tr> <td>20 + 20 + 20 + 20 + 71</td> <td>151</td> </tr> <tr> <td>20 + 20 + 20 + 20 + 80</td> <td>160</td> </tr> <tr> <td>20 + 20 + 20 + 25 + 71</td> <td>156</td> </tr> <tr> <td>20 + 20 + 20 + 50 + 50</td> <td>160</td> </tr> </tbody> </table>	Indoor units combination	Total	20 + 20 + 20 + 20 + 71	151	20 + 20 + 20 + 20 + 80	160	20 + 20 + 20 + 25 + 71	156	20 + 20 + 20 + 50 + 50
Indoor units combination	Total										
20 + 20 + 20 + 20 + 71	151										
20 + 20 + 20 + 20 + 80	160										
20 + 20 + 20 + 25 + 71	156										
20 + 20 + 20 + 50 + 50	160										

(3) Safety precautions in handling air-conditioners with flammable refrigerant

RSA012A090D

R32 REFRIGERANT USED

	This equipment uses flammable refrigerants. If the refrigerant is leaked, together with an external ignition source, there is a possibility of ignition.		There is information included in the user's manual and/or installation manual.
	The user's manual should be read carefully.		A service personnel should be handling this equipment with reference to the installation manual.

- This safety precaution sheet is for R32 refrigerant. If you want to know the type of refrigerant in the unit, check the label attached to the outdoor unit.
- The precautionary items mentioned below are distinguished into two levels, [WARNING] and [CAUTION].

[WARNING] : Wrong installation would cause serious consequences such as injuries or death.

[CAUTION] : Wrong installation might cause serious consequences depending on circumstances.

WARNING

- Strict compliance of the domestic laws must be observed when disposing the appliance.
- Do not use means to accelerate the defrosting process or to clean, other than those recommended by the manufacturer.
- The appliance shall be stored in a room without continuously operating ignition sources (for example: open flames, an operating gas appliance or an operating electric heater).
- Do not pierce or burn.
- Be aware that refrigerants may not contain an odour.
- The ducts connected to an appliance shall not contain a potential ignition source.

CAUTION

1. General

- That the installation of pipe-work shall be kept to a minimum.
- That pipe-work shall be protected from physical damage.
- That compliance with national gas regulations shall be observed.
- That mechanical connections shall be accessible for maintenance purposes.
- Keep any required ventilation openings clear of obstruction.
- Servicing shall be performed only as recommended by the manufacturer.
- Equipment piping in the occupied space shall be installed in such a way to protect against accidental damage in operation and service.
- Precautions shall be taken to avoid excessive vibration or pulsation to refrigerating piping.
- Protection devices, piping and fittings shall be protected as far as possible against adverse environmental effects, for example, the danger of water collecting and freezing in relief pipes or the accumulation of dirt and debris.
- Provision shall be made for expansion and contraction of long runs of piping.
- Piping in refrigerating systems shall be so designed and installed to minimize the likelihood hydraulic shock damaging the system.
- The indoor equipment and pipes shall be securely mounted and guarded such that accidental rupture of equipment cannot occur from such events as moving furniture or reconstruction activities.
- Instructions for wiring to external zoning dampers and/or mechanical ventilation, to ensure that upon detection of a leak, the zoning dampers are driven fully open and additional mechanical ventilation is activated.
- For appliances using A2L refrigerants, connected via an air duct system to one or more rooms, the supply and return air shall be directly ducted to the space. Open areas such as false ceilings shall not be used as a return air duct.
- The following information requirements apply for enhanced tightness refrigerating systems using A2L refrigerants.
- Where safety shut off valves are specified, the minimum room area may be determined based on the maximum amount of refrigerant that can be leaked as determined in GG.12.2. (IEC 60335-2-40:2018)
- Where safety shut off valves are specified, the location of the valve in the refrigerating system relative to the occupied spaces shall be as described in GG.12.1.(IEC 60335-2-40:2018)

2. Unventilated areas

- The appliance shall be stored in a well-ventilated area where the room size corresponds to the room area as specified for operation.
- If the refrigerant charge amount in the system is ≥ 1.84 kg, an unventilated area where the appliance is installed shall be so constructed that should any refrigerant leak, it will not stagnate so as to create a fire or explosion hazard.

3. Qualification of workers

- The staff in servicing operations must hold the national qualification or other relevant qualifications.

4. Information on servicing

- 4.1 Checks to the area**
 - Prior to beginning work on systems containing flammable refrigerants, safety checks are necessary to ensure that the risk of ignition is minimised.
 - For repair to the refrigerating system, 4.2 to 4.6 shall be completed prior to conducting work on the system.
- 4.2 Work procedure**
 - Work shall be undertaken under a controlled procedure so as to minimise the risk of a flammable gas or vapour being present while the work is being performed.
- 4.3 General work area**
 - All maintenance staff and others working in the local area shall be instructed on the nature of work being carried out.
 - Work in confined spaces shall be avoided.
- 4.4 Checking for presence of refrigerant**
 - The area shall be checked with an appropriate refrigerant detector prior to and during work, to ensure the technician is aware of potentially toxic or flammable atmospheres.
 - Ensure that the leak detection equipment being used is suitable for use with all applicable refrigerants, i.e. non-sparking, adequately sealed or intrinsically safe.
- 4.5 Presence of fire extinguisher**
 - If any hot work is to be conducted on the refrigerating equipment or any associated parts, appropriate fire extinguishing equipment shall be available to hand. Have a dry powder or CO₂ fire extinguisher adjacent to the charging area.

4.6 No ignition sources

- No person carrying out work in relation to a refrigerating system which involves exposing any pipe work shall use any sources of ignition in such a manner that it may lead to the risk of fire or explosion.
- All possible ignition sources, including cigarette smoking, should be kept sufficiently far away from the site of installation, repairing, removing and disposal, during which refrigerant can possibly be released to the surrounding space.
- Prior to work taking place, the area around the equipment is to be surveyed to make sure that there are no flammable hazards or ignition risks.
- "No Smoking" signs shall be displayed.

4.7 Ventilated area

- Ensure that the area is in the open or that it is adequately ventilated before breaking into the system or conducting any hot work.
- A degree of ventilation shall continue during the period that the work is carried out.
- The ventilation should safely disperse any released refrigerant and preferably expel it externally into the atmosphere.

4.8 Checks to the refrigerating equipment

- Where electrical components are being changed, they shall be fit for the purpose and to the correct specification.
- At all times the manufacturer's maintenance and service guidelines shall be followed.
- If in doubt consult the manufacturer's technical department for assistance.
- The following checks shall be applied to installations using flammable refrigerants:
 - the actual refrigerant charge is in accordance with the room size within which the refrigerant containing parts are installed;
 - the ventilation machinery and outlets are operating adequately and are not obstructed;
 - if an indirect refrigerating circuit is being used, the secondary circuit shall be checked for the presence of refrigerant;
 - marking to the equipment continues to be visible and legible. Markings and signs that are illegible shall be corrected;
 - refrigerating pipe or components are installed in a position where they are unlikely to be exposed to any substance which may corrode refrigerant containing components, unless the components are constructed of materials which are inherently resistant to being corroded or are suitably protected against being so corroded.

⚠ CAUTION

4.9 Checks to electrical devices

- Repair and maintenance to electrical components shall include initial safety checks and component inspection procedures.
- If a fault exists that could compromise safety, then no electrical supply shall be connected to the circuit until it is satisfactorily dealt with.
- If the fault cannot be corrected immediately but it is necessary to continue operation, an adequate temporary solution shall be used.
- This shall be reported to the owner of the equipment so all parties are advised.
- Initial safety checks shall include:
 - that capacitors are discharged: this shall be done in a safe manner to avoid possibility of sparking;
 - that no live electrical components and wiring are exposed while charging, recovering or purging the system;
 - that there is continuity of earth bonding.

5. Repairs to sealed components

- During repairs to sealed components, all electrical supplies shall be disconnected from the equipment being worked upon prior to any removal of sealed covers, etc.
- If it is absolutely necessary to have an electrical supply to equipment during servicing, then a permanently operating form of leak detection shall be located at the most critical point to warn of a potentially hazardous situation.
- Particular attention shall be paid to the following to ensure that by working on electrical components, the casing is not altered in such a way that the level of protection is affected. This shall include damage to cables, excessive number of connections, terminals not made to original specification, damage to seals, incorrect fitting of glands, etc.
- Ensure that the apparatus is mounted securely.
- Ensure that seals or sealing materials have not degraded to the point that they no longer serve the purpose of preventing the ingress of flammable atmospheres.
- Replacement parts shall be in accordance with the manufacturer's specifications.

6. Repair to intrinsically safe components

- Do not apply any permanent inductive or capacitance loads to the circuit without ensuring that this will not exceed the permissible voltage and current permitted for the equipment in use.
- Intrinsically safe components are the only types that can be worked on while live in the presence of a flammable atmosphere.
- The test apparatus shall be at the correct rating.
- Replace components only with parts specified by the manufacturer.
- Other parts may result in the ignition of refrigerant in the atmosphere from a leak.

NOTE

The use of silicon sealant can inhibit the effectiveness of some types of leak detection equipment. Intrinsically safe components do not have to be isolated prior to working on them.

7. Cabling

- Check that cabling will not be subject to wear, corrosion, excessive pressure, vibration, sharp edges or any other adverse environmental effects. The check shall also take into account the effects of aging or continual vibration from sources such as compressors or fans.

8. Detection of flammable refrigerants

- Under no circumstances shall potential sources of ignition be used in the searching for or detection of refrigerant leaks.
- A halide torch (or any other detector using a naked flame) shall not be used.
- Electronic leak detectors may be used to detect refrigerant leaks but, in the case of flammable refrigerants, the sensitivity may not be adequate, or may need re-calibration. (Detection equipment shall be calibrated in a refrigerant-free area.)
- Ensure that the detector is not a potential source of ignition and is suitable for the refrigerant used.
- Leak detection equipment shall be set at a percentage of the LFL of the refrigerant and shall be calibrated to the refrigerant employed, and the appropriate percentage of gas (25 % maximum) is confirmed.
- Leak detection fluids are suitable for use with most refrigerants but the use of detergents containing chlorine shall be avoided as the chlorine may react with the refrigerant and corrode the copper pipe-work.

NOTE

Examples of leak detection fluids are

- bubble method,
- fluorescent method agents.
- If a leak is suspected, all naked flames shall be removed/extinguished.
- If a leakage of refrigerant is found which requires brazing, all of the refrigerant shall be recovered from the system, or isolated (by means of shut off valves) in a part of the system remote from the leak.
- Removal of refrigerant shall be according to Item 9.

9. Removal and evacuation

- When breaking into the refrigerant circuit to make repairs – or for any other purpose – conventional procedures shall be used. However, for flammable refrigerants it is important that best practice is followed since flammability is a consideration.
- The following procedure shall be adhered to:
 - remove refrigerant;
 - purge the circuit with inert gas (optional for A2L);
 - evacuate (optional for A2L);
 - purge with inert gas (optional for A2L);
 - open the circuit by cutting or brazing.
- The refrigerant charge shall be recovered into the correct recovery cylinders.
- For appliances containing flammable refrigerants other than A2L refrigerants, the system shall be purged with oxygen-free nitrogen to render the appliance safe for flammable refrigerants.
- This process may need to be repeated several times.
- Compressed air or oxygen shall not be used for purging refrigerant systems.
- For appliances containing flammable refrigerants, other than A2L refrigerants, refrigerants purging shall be achieved by breaking the vacuum in the system with oxygen-free nitrogen and continuing to fill until the working pressure is achieved, then venting to atmosphere, and finally pulling down to a vacuum. This process shall be repeated until no refrigerant is within the system.
- When the final oxygen-free nitrogen charge is used, the system shall be vented down to atmospheric pressure to enable work to take place. This operation is absolutely vital if brazing operations on the pipe-work are to take place.
- Ensure that the outlet for the vacuum pump is not close to any ignition sources and that ventilation is available.

10. Charging procedures

- In addition to conventional charging procedures, the following requirements shall be followed.
 - Ensure that contamination of different refrigerants does not occur when using charging equipment. Hoses or lines shall be as short as possible to minimise the amount of refrigerant contained in them.
 - Cylinders shall be kept in an appropriate position according to the instructions.
 - Ensure that the refrigerating system is earthed prior to charging the system with refrigerant.
 - Label the system when charging is complete (if not already).
 - Extreme care shall be taken not to overfill the refrigerating system.
- Prior to recharging the system, it shall be pressure-tested with the appropriate purging gas.
- The system shall be leak-tested on completion of charging but prior to commissioning.
- A follow up leak test shall be carried out prior to leaving the site.

11. Decommissioning

- Before carrying out this procedure, it is essential that the technician is completely familiar with the equipment and all its detail.
- It is recommended good practice that all refrigerants are recovered safely.
- Prior to the task being carried out, an oil and refrigerant sample shall be taken in case analysis is required prior to re-use of recovered refrigerant.
- It is essential that electrical power is available before the task is commenced.
 - a) Become familiar with the equipment and its operation.
 - b) Isolate system electrically.
 - c) Before attempting the procedure ensure that:
 - mechanical handling equipment is available, if required, for handling refrigerant cylinders;
 - all personal protective equipment is available and being used correctly;
 - the recovery process is supervised at all times by a competent person;
 - recovery equipment and cylinders conform to the appropriate standards.
 - d) Pump down refrigerant system, if possible.
 - e) If a vacuum is not possible, make a manifold so that refrigerant can be removed from various parts of the system.
 - f) Make sure that cylinder is situated on the scales before recovery takes place.
 - g) Start the recovery machine and operate in accordance with instructions.
 - h) Do not overfill cylinders. (No more than 80 % volume liquid charge).
 - i) Do not exceed the maximum working pressure of the cylinder, even temporarily.
 - j) When the cylinders have been filled correctly and the process completed, make sure that the cylinders and the equipment are removed from site promptly and all isolation valves on the equipment are closed off.
 - k) Recovered refrigerant shall not be charged into another refrigerating system unless it has been cleaned and checked.

12. Labelling

- Equipment shall be labelled stating that it has been de-commissioned and emptied of refrigerant. The label shall be dated and signed.
- For appliances containing flammable refrigerants, ensure that there are labels on the equipment stating the equipment contains flammable refrigerant.

 **CAUTION**

13. Recovery

- When removing refrigerant from a system, either for servicing or decommissioning, it is recommended good practice that all refrigerants are removed safely.
 - When transferring refrigerant into cylinders, ensure that only appropriate refrigerant recovery cylinders are employed.
 - Ensure that the correct number of cylinders for holding the total system charge is available.
 - All cylinders to be used are designated for the recovered refrigerant and labelled for that refrigerant (i.e. special cylinders for the recovery of refrigerant).
 - Cylinders shall be complete with pressure relief valve and associated shut-off valves in good working order.
 - Empty recovery cylinders are evacuated and, if possible, cooled before recovery occurs.
 - The recovery equipment shall be in good working order with a set of instructions concerning the equipment that is at hand and shall be suitable for the recovery of all appropriate refrigerants including, when applicable, flammable refrigerants.
- In addition, a set of calibrated weighing scales shall be available and in good working order.
 - Hoses shall be complete with leak-free disconnect couplings and in good condition.
 - Before using the recovery machine, check that it is in satisfactory working order, has been properly maintained and that any associated electrical components are sealed to prevent ignition in the event of a refrigerant release. Consult manufacturer if in doubt.
 - The recovered refrigerant shall be returned to the refrigerant supplier in the correct recovery cylinder, and the relevant Waste Transfer Note arranged. Do not mix refrigerants in recovery units and especially not in cylinders.
 - If compressors or compressor oils are to be removed, ensure that they have been evacuated to an acceptable level to make certain that flammable refrigerant does not remain within the lubricant.
 - The evacuation process shall be carried out prior to returning the compressor to the suppliers.
 - Only electric heating to the compressor body shall be employed to accelerate this process.
 - When oil is drained from a system, it shall be carried out safely.

14. Other safety precautions

- A brazed, welded, or mechanical connection shall be made before opening the valves to permit refrigerant to flow between the refrigerating system parts.
- Flammable refrigerant used, refrigerant tubing protected or enclosed to avoid mechanical damage (IEC/EN 60335-2-40).
- Tubing protected to extent that it will not be handled or used for carrying during moving of product (IEC/EN 60335-2-40).
- Flammable refrigerant used, low temperature solder alloys, such as lead/tin alloys, not acceptable for pipe connections (IEC/EN 60335-2-40).
- Do not use flare nut indoor which is locally procured.

Selection of installation location for the indoor unit

- Minimum installation area for indoor unit

⚠ CAUTION

The indoor unit shall be installed in a room with minimum installation area or more according to the refrigerant charge amount (factory refrigerant charge + additional refrigerant charge).

For factory refrigerant charge, refer to the outdoor unit label model name or installation sheet.

For additional refrigerant charge, refer to the outdoor unit installation sheet.

- If the refrigerant charge amount in the system is < 1.84 kg, there are no additional minimum floor area requirements.
- If the refrigerant charge amount in the system is ≥ 1.84 kg, you need to comply with additional minimum floor area requirements as described in the following table.
- For further details regarding the installation location of indoor unit, refer to technical manual.

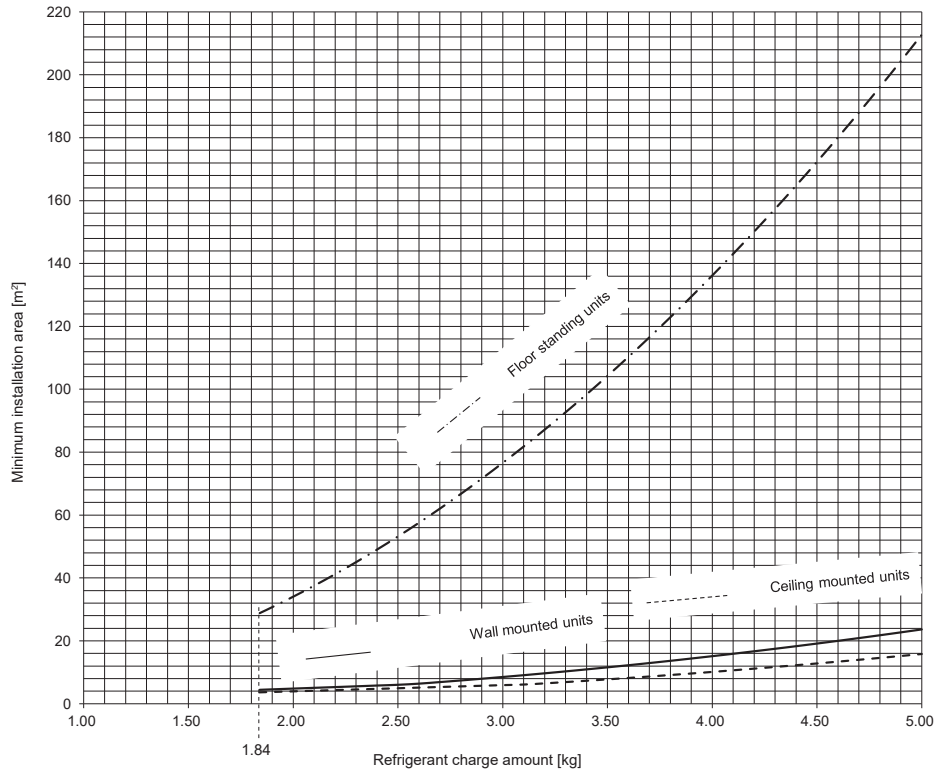

Figure 1. Minimum installation area (A min) graph

Table 1. Minimum installation area (A min) table

Refrigerant charge amount [kg]	Minimum installation area [m ²]					
	Wall mounted units H=1.8 m	Ceiling mounted units H=2.2 m	Floor standing units H=0.6 m*			
1.00	No requirements					
1.10						
1.20						
1.30						
1.40						
1.50						
1.60						
1.70						
1.80	No requirements					
1.84				4.44	3.64	28.82
1.90				4.59	3.76	30.73
2.00				4.83	3.95	34.05
2.10				5.07	4.15	37.54
2.20				5.31	4.35	41.20
2.30				5.55	4.55	45.03
2.40				5.80	4.74	49.03
2.50	6.04	4.94	53.20			
2.60	6.40	5.14	57.54			
2.70	6.90	5.34	62.05			
2.80	7.42	5.53	66.73			
2.90	7.96	5.73	71.58			

Refrigerant charge amount [kg]	Minimum installation area [m ²]		
	Wall mounted units H=1.8 m	Ceiling mounted units H=2.2 m	Floor standing units H=0.6 m*
3.00	8.52	5.93	76.60
3.10	9.09	6.12	81.79
3.20	9.69	6.49	87.16
3.30	10.30	6.90	92.69
3.40	10.94	7.32	98.39
3.50	11.59	7.76	104.26
3.60	12.26	8.21	110.31
3.70	12.95	8.67	116.52
3.80	13.66	9.15	122.90
3.90	14.39	9.63	129.45
4.00	15.14	10.13	136.18
4.10	15.90	10.65	143.07
4.20	16.69	11.17	150.14
4.30	17.49	11.71	157.37
4.40	18.31	12.26	164.77
4.50	19.15	12.82	172.35
4.60	20.01	13.40	180.09
4.70	20.89	13.99	188.01
4.80	21.79	14.59	196.09
4.90	22.71	15.20	204.35
5.00	23.65	15.83	212.78

*For floor standing units, the value of installation height (H) is considered 0.6 m to comply to IEC 60335-2-40:2018 Clause GG.2.

(4) Guidance of the connected room

- (a) If the installation area (A_{room}) < Minimum installation area, consider the "opening conditions for connected rooms and natural ventilation"
(IEC 60335-2-40:2018 Clause GG1.4)
- (b) Determine total floor area of A_{room} and B_{room} (Adjacent room)
(i) Calculate the area of A_{room} and B_{room}
(ii) The total area of ($A_{\text{room}} + B_{\text{room}}$) must exceed A_{min} (Minimum installation area).
- (c) Determine Minimum venting opening area (A_{nvmin})
(i) From Table 2, calculate the Maximum refrigerant charge in a room (m_{max})
(ii) From Table 3, calculate the Minimum venting opening area (A_{nvmin})
(iii) The unit can be installed the room which is applied following conditions.
- 1) Two permanent openings, one at bottom, another at top, for ventilation purposes are made between A_{room} and B_{room} .
 - 2) Openings are permanent openings which cannot be closed.
 - 3) The height of the openings must more than 20mm.
 - 4) The opening to outdoor is not encouraged for ventilation opening.
 - 5) Bottom opening
 - ① Must comply to the Minimum venting opening area (A_{nvmin}).
 - ② Opening must be located 300mm from the floor.
 - ③ At least 50% of the required opening area A_{nvmin} shall be below 200mm from the floor.
 - ④ The bottom of the lowest openings shall not be higher than the point of release when the unit is installed and must be situated more than 100mm from the floor.
 - 6) Top opening
 - ① The total size of top opening must be more than 50% of A_{nvmin} .
 - ② Opening must be located 1,500mm above the floor.

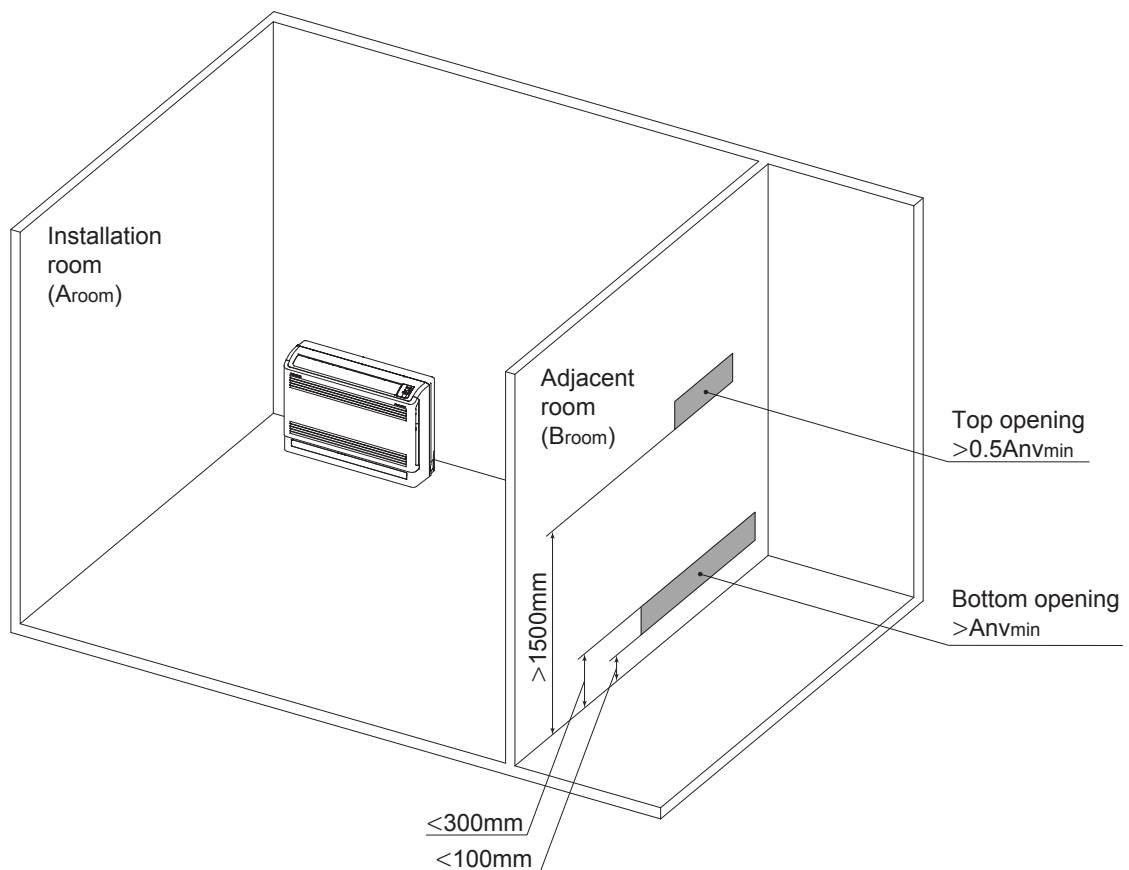

Table 2. Maximum refrigerant charge in a room (m_{max})

A _{room} [m ²]	Maximum refrigerant charge in a room (m _{max}) [kg]		
	Wall mounted units	Ceiling mounted units	Floor standing units
	H=1.8m	H=2.2m	H=0.6m
2	0.828	1.013	0.276
4	1.657	2.026	0.552
6	2.486	3.039	0.828
8	2.908	3.554	0.969
10	3.251	3.974	1.083
12	3.562	4.353	1.187
14	3.847	4.702	1.282
16	4.113	5.027	1.371
18	4.362	5.332	1.454
20	4.598	5.620	1.532
22	4.823	5.895	1.607
24	5.037	6.157	1.679
26	5.243	6.408	1.747
28	5.441	6.650	1.813
30	5.632	6.884	1.877
32	5.817	7.109	1.939
34	5.996	7.328	1.998
36	6.170	7.541	2.056
38	6.339	7.747	2.113
40	6.503	7.949	2.167
42	6.664	8.145	2.221
44	6.821	8.337	2.273
46	6.974	8.524	2.324
48	7.124	8.707	2.374
50	7.271	8.887	2.423
52	7.415	9.063	2.471
54	7.556	9.235	2.518
56	7.695	9.405	2.565
58	7.831	9.571	2.610
60	7.965	9.735	2.655
62	8.097	9.896	2.699
64	8.226	10.054	2.742
66	8.354	10.210	2.784
68	8.479	10.364	2.826
70	8.603	10.515	2.867
72	8.725	10.664	2.908
74	8.846	10.811	2.948
76	8.964	10.957	2.988
78	9.082	11.100	3.027
80	9.197	11.241	3.065

Table 3. Minimum venting opening area (Anvmin)

mc[kg]	mmax[kg]	mc-mmax[kg]	Minimum venting opening area (Anvmin)[cm ²]		
			Wall mounted units	Ceiling mounted units	Floor standing units
			H=1.8m	H=2.2m	H=0.6m
3.0	0.6	2.4	561	508	972
3.0	0.8	2.2	515	465	891
3.0	1.0	2.0	468	423	878
3.0	1.2	1.8	421	381	866
3.0	1.4	1.6	374	339	831
3.0	1.6	1.4	328	296	777
3.0	1.8	1.2	281	254	707
3.0	2.0	1.0	234	212	621
3.0	2.2	0.8	187	170	521
3.0	2.4	0.6	141	127	408
3.0	2.6	0.4	95	85	283
3.0	2.8	0.2	49	43	147
3.2	0.6	2.6	608	550	1053
3.2	0.8	2.4	561	508	972
3.2	1.0	2.2	514	465	966
3.2	1.2	2.0	468	423	962
3.2	1.4	1.8	421	381	935
3.2	1.6	1.6	374	339	888
3.2	1.8	1.4	328	296	825
3.2	2.0	1.2	281	254	745
3.2	2.2	1.0	234	212	651
3.2	2.4	0.8	187	170	544
3.2	2.6	0.6	142	127	425
3.2	2.8	0.4	98	85	294
3.2	3.0	0.2	51	43	152
3.4	0.6	2.8	655	592	1133
3.4	0.8	2.6	608	550	1052
3.4	1.0	2.4	561	508	1053
3.4	1.2	2.2	514	465	1058
3.4	1.4	2.0	468	423	1039
3.4	1.6	1.8	421	381	999
3.4	1.8	1.6	374	339	942
3.4	2.0	1.4	328	296	869
3.4	2.2	1.2	281	254	781
3.4	2.4	1.0	234	212	680
3.4	2.6	0.8	189	170	566
3.4	2.8	0.6	147	127	441
3.4	3.0	0.4	102	85	304
3.4	3.2	0.2	53	43	157
3.6	0.6	3.0	701	635	1214
3.6	0.8	2.8	655	592	1133
3.6	1.0	2.6	608	550	1141
3.6	1.2	2.4	561	508	1154
3.6	1.4	2.2	514	465	1143
3.6	1.6	2.0	468	423	1110
3.6	1.8	1.8	421	381	1060
3.6	2.0	1.6	374	339	993
3.6	2.2	1.4	328	296	912
3.6	2.4	1.2	281	254	816
3.6	2.6	1.0	236	212	708
3.6	2.8	0.8	196	170	588
3.6	3.0	0.6	152	127	456
3.6	3.2	0.4	105	86	314
3.6	3.4	0.2	54	45	162
3.7	0.6	3.1	725	656	1255
3.7	0.8	2.9	678	613	1174
3.7	1.0	2.7	631	571	1185
3.7	1.2	2.5	585	529	1202
3.7	1.4	2.3	538	486	1194
3.7	1.6	2.1	491	444	1166
3.7	1.8	1.9	444	402	1119
3.7	2.0	1.7	398	360	1055
3.7	2.2	1.5	351	317	977
3.7	2.4	1.3	304	275	884
3.7	2.6	1.1	260	233	779
3.7	2.8	0.9	221	191	661
3.7	3.0	0.7	178	148	532
3.7	3.2	0.5	131	108	393
3.7	3.4	0.3	81	67	243
3.7	3.6	0.1	28	23	84

2. INDOOR UNITS

2.1 Specifications

(1) Wall mounted type (SRK, SKM)

(a) Models SRK20, 25, 35, 50, 60ZSX-W, -WB, -WT

Adapted to RoHS directive

Item		Model	SRK20ZSX-W, -WB, -WT	
Power source			1 Phase, 220–240V, 50Hz / 220V, 60Hz	
Operation data	Nominal cooling capacity (range)	kW	2.0	
	Nominal heating capacity (range)	kW	3.0	
	Sound power level	Cooling		53
		Heating		55
	Sound pressure level	Cooling	dB(A)	Hi: 38 Me: 31 Lo: 24 ULo: 19
		Heating		Hi: 38 Me: 33 Lo: 25 ULo: 19
Silent mode sound pressure level			—	
Exterior dimensions (Height x Width x Depth)		mm	305 x 920 x 220	
Exterior appearance (4) (Equivalent color)			SRK20ZSX-W : Fine snow (8.0Y 9.3/0.1) , RAL : 9003	
Net weight		kg	13	
Heat exchanger			Louver fins & inner grooved tubing	
Fan type & Q'ty			Tangential fan x 1	
Fan motor (Starting method)		W	42 x1 (Direct drive)	
Air flow	Cooling	m ³ /min	Hi: 11.3 Me: 9.1 Lo: 6.0 ULo: 5.0	
	Heating		Hi: 12.2 Me: 10.3 Lo: 7.2 ULo: 5.4	
Available external static pressure		Pa	0	
Outside air intake			Not possible	
Air filter, Quality / Quantity			Polypropylene net (washable) x 2	
Shock & vibration absorber			Rubber sleeve (for fan motor)	
Operation control	Remote control		Wireless remote control	
	Room temperature control		Microcomputer thermostat	
	Operation display		RUN: Green, TIMER: Yellow, ECO: Blue	
Safety equipments			Frost protection, Serial signal error protection, Indoor fan motor error protection	
Installation data	Refrigerant piping size (O.D)	mm	Liquid line: ϕ 6.35 (1/4") Gas line: ϕ 9.52 (3/8")	
	Connecting method		Flare connection	
	Attached length of piping	m	Liquid line : 0.55 / Gas line : 0.48	
	Insulation for piping		Necessary (Both sides), independent	
	Drain hose		Hose connectable (VP16)	
Drain pump, max lift height		mm	—	
Interconnecting wires	Size x Core number		1.5mm ² x 4 cores (Including earth cable) / Terminal block (Screw fixing type)	
IP number			IPX0	
Standard accessories			Mounting kit, Clean filter (Allergen clear filter x 1, Photocatalytic washable deodorizing filter x 1)	
Option parts			Interface kit (SC-BIKN2-E)	

Notes (1) The data are measured at the following conditions.

The pipe length is 5m.

Operation	Item	Indoor air temperature		Outdoor air temperature		Standards
		DB	WB	DB	WB	
Cooling		27°C	19°C	35°C	24°C	ISO15042-T1
Heating		20°C	—	7°C	6°C	ISO15042-H1

(2) This air-conditioner is manufactured and tested in conformity with the ISO.

(3) Sound level indicates the value in an anechoic chamber.

During operation these values are somewhat higher due to ambient conditions.

(4) The difference in appearance color is as follows.

Item	Model	SRK20ZSX-WB	SRK20ZSX-WT
Exterior appearance (Equivalent color)		Fine snow (8.0Y 9.3 / 0.1) , RAL : 9003 Black (4.0PB 2.44 / 0.25) , RAL : 9011	Titanium gray (1.6Y 6.59 / 0.63) , RAL : 7048 Black (4.0PB 2.44 / 0.25) , RAL : 9011

Adapted to **RoHS** directive

Item		Model	SRK25ZSX-W, -WB, -WT		
Power source			1 Phase, 220-240V, 50Hz / 220V, 60Hz		
Operation data	Nominal cooling capacity (range)	kW	2.5		
	Nominal heating capacity (range)	kW	3.4		
	Sound power level	Cooling	dB(A)	55	
		Heating		56	
	Sound pressure level	Cooling		Hi: 39 Me: 33 Lo: 25 ULo: 19	
		Heating		Hi: 40 Me: 34 Lo: 27 ULo: 19	
Silent mode sound pressure level		-			
Exterior dimensions (Height x Width x Depth)		mm		305 x 920 x 220	
Exterior appearance (4) (Equivalent color)			SRK25ZSX-W : Fine snow (8.0Y 9.3/0.1) , RAL : 9003		
Net weight		kg	13		
Heat exchanger			Louver fins & inner grooved tubing		
Fan type & Q'ty			Tangential fan x 1		
Fan motor (Starting method)		W	42 x1 (Direct drive)		
Air flow	Cooling	m ³ /min	Hi: 12.2 Me: 10.0 Lo: 6.7 ULo: 5.0		
	Heating		Hi: 12.8 Me: 11.0 Lo: 7.8 ULo: 5.4		
Available external static pressure		Pa	0		
Outside air intake			Not possible		
Air filter, Quality / Quantity			Polypropylene net (washable) x 2		
Shock & vibration absorber			Rubber sleeve (for fan motor)		
Operation control	Remote control		Wireless remote control		
	Room temperature control		Microcomputer thermostat		
	Operation display		RUN: Green, TIMER: Yellow, ECO: Blue		
Safety equipments			Frost protection, Serial signal error protection, Indoor fan motor error protection		
Installation data	Refrigerant piping size (O.D)	mm	Liquid line: ϕ 6.35 (1/4") Gas line: ϕ 9.52 (3/8")		
	Connecting method		Flare connection		
	Attached length of piping	m	Liquid line : 0.55 / Gas line : 0.48		
	Insulation for piping		Necessary (Both sides), independent		
	Drain hose		Hose connectable (VP16)		
Drain pump, max lift height		mm	-		
Interconnecting wires	Size x Core number		1.5mm ² x 4 cores (Including earth cable) / Terminal block (Screw fixing type)		
IP number			IPX0		
Standard accessories			Mounting kit, Clean filter (Allergen clear filter x 1, Photocatalytic washable deodorizing filter x 1)		
Option parts			Interface kit (SC-BIKN2-E)		

Notes (1) The data are measured at the following conditions.

The pipe length is 5m.

Operation	Item	Indoor air temperature		Outdoor air temperature		Standards
		DB	WB	DB	WB	
Cooling		27°C	19°C	35°C	24°C	ISO15042-T1
Heating		20°C	-	7°C	6°C	ISO15042-H1

(2) This air-conditioner is manufactured and tested in conformity with the ISO.

(3) Sound level indicates the value in an anechoic chamber.

During operation these values are somewhat higher due to ambient conditions.

(4) The difference in appearance color is as follows.

Item	Model	SRK25ZSX-WB	SRK25ZSX-WT
Exterior appearance (Equivalent color)		Fine snow (8.0Y 9.3 / 0.1) , RAL : 9003 Black (4.0PB 2.44 / 0.25) , RAL : 9011	Titanium gray (1.6Y 6.59 / 0.63) , RAL : 7048 Black (4.0PB 2.44 / 0.25) , RAL : 9011

Adapted to **RoHS** directive

Item		Model	SRK35ZSX-W, -WB, -WT		
Power source			1 Phase, 220-240V, 50Hz / 220V, 60Hz		
Operation data	Nominal cooling capacity (range)	kW	3.5		
	Nominal heating capacity (range)	kW	4.5		
	Sound power level	Cooling	dB(A)	58	
		Heating		58	
	Sound pressure level	Cooling		Hi: 43 Me: 35 Lo: 26 ULo: 19	
		Heating		Hi: 42 Me: 35 Lo: 28 ULo: 19	
Silent mode sound pressure level		-			
Exterior dimensions (Height x Width x Depth)		mm		305 x 920 x 220	
Exterior appearance (4) (Equivalent color)			SRK35ZSX-W : Fine snow (8.0Y 9.3/0.1) , RAL : 9003		
Net weight		kg	13		
Heat exchanger			Louver fins & inner grooved tubing		
Fan type & Q'ty			Tangential fan x 1		
Fan motor (Starting method)		W	42 x1 (Direct drive)		
Air flow	Cooling	m ³ /min	Hi: 13.1 Me: 10.8 Lo: 7.3 ULo: 5.0		
	Heating		Hi: 13.9 Me: 11.8 Lo: 8.6 ULo: 5.4		
Available external static pressure		Pa	0		
Outside air intake			Not possible		
Air filter, Quality / Quantity			Polypropylene net (washable) x 2		
Shock & vibration absorber			Rubber sleeve (for fan motor)		
Operation control	Remote control		Wireless remote control		
	Room temperature control		Microcomputer thermostat		
	Operation display		RUN: Green, TIMER: Yellow, ECO: Blue		
Safety equipments			Frost protection, Serial signal error protection, Indoor fan motor error protection		
Installation data	Refrigerant piping size (O.D)	mm	Liquid line: ϕ 6.35 (1/4") Gas line: ϕ 9.52 (3/8")		
	Connecting method		Flare connection		
	Attached length of piping	m	Liquid line : 0.55 / Gas line : 0.48		
	Insulation for piping		Necessary (Both sides), independent		
	Drain hose		Hose connectable (VP16)		
Drain pump, max lift height		mm	-		
Interconnecting wires	Size x Core number		1.5mm ² x 4 cores (Including earth cable) / Terminal block (Screw fixing type)		
IP number			IPX0		
Standard accessories			Mounting kit, Clean filter (Allergen clear filter x 1, Photocatalytic washable deodorizing filter x 1)		
Option parts			Interface kit (SC-BIKN2-E)		

Notes (1) The data are measured at the following conditions.

The pipe length is 5m.

Operation	Item	Indoor air temperature		Outdoor air temperature		Standards
		DB	WB	DB	WB	
Cooling		27°C	19°C	35°C	24°C	ISO15042-T1
Heating		20°C	-	7°C	6°C	ISO15042-H1

(2) This air-conditioner is manufactured and tested in conformity with the ISO.

(3) Sound level indicates the value in an anechoic chamber.

During operation these values are somewhat higher due to ambient conditions.

(4) The difference in appearance color is as follows.

Item	Model	SRK35ZSX-WB	SRK35ZSX-WT
Exterior appearance (Equivalent color)		Fine snow (8.0Y 9.3 / 0.1) , RAL : 9003 Black (4.0PB 2.44 / 0.25) , RAL : 9011	Titanium gray (1.6Y 6.59 / 0.63) , RAL : 7048 Black (4.0PB 2.44 / 0.25) , RAL : 9011

Adapted to **RoHS** directive

Item		Model	SRK50ZSX-W, -WB, -WT	
Power source			1 Phase, 220-240V, 50Hz / 220V, 60Hz	
Operation data	Nominal cooling capacity (range)	kW	5.0	
	Nominal heating capacity (range)	kW	5.8	
	Sound power level	Cooling	dB(A)	59
		Heating		62
	Sound pressure level	Cooling		Hi: 44 Me: 39 Lo: 31 ULo: 22
		Heating		Hi: 47 Me: 41 Lo: 33 ULo: 23
Silent mode sound pressure level		—		
Exterior dimensions (Height x Width x Depth)		mm		305 x 920 x 220
Exterior appearance (4) (Equivalent color)			SRK50ZSX-W : Fine snow (8.0Y 9.3/0.1) , RAL : 9003	
Net weight		kg	13	
Heat exchanger			Louver fins & inner grooved tubing	
Fan type & Q'ty			Tangential fan x 1	
Fan motor (Starting method)		W	42 x1 (Direct drive)	
Air flow	Cooling	m ³ /min	Hi: 14.3 Me: 12.4 Lo: 7.8 ULo: 5.4	
	Heating		Hi: 17.3 Me: 14.3 Lo: 9.8 ULo: 6.2	
Available external static pressure		Pa	0	
Outside air intake			Not possible	
Air filter, Quality / Quantity			Polypropylene net (washable) x 2	
Shock & vibration absorber			Rubber sleeve (for fan motor)	
Operation control	Remote control		Wireless remote control	
	Room temperature control		Microcomputer thermostat	
	Operation display		RUN: Green, TIMER: Yellow, ECO: Blue	
Safety equipments			Frost protection, Serial signal error protection, Indoor fan motor error protection	
Installation data	Refrigerant piping size (O.D)	mm	Liquid line: ϕ 6.35 (1/4") Gas line: ϕ 12.7 (1/2")	
	Connecting method		Flare connection	
	Attached length of piping	m	Liquid line : 0.55 / Gas line : 0.48	
	Insulation for piping		Necessary (Both sides), independent	
	Drain hose		Hose connectable (VP16)	
Drain pump, max lift height		mm	—	
Interconnecting wires	Size x Core number		1.5mm ² x 4 cores (Including earth cable) / Terminal block (Screw fixing type)	
IP number			IPX0	
Standard accessories			Mounting kit, Clean filter (Allergen clear filter x 1, Photocatalytic washable deodorizing filter x 1)	
Option parts			Interface kit (SC-BIKN2-E)	

Notes (1) The data are measured at the following conditions.

The pipe length is 5m.

Operation \ Item	Indoor air temperature		Outdoor air temperature		Standards
	DB	WB	DB	WB	
Cooling	27°C	19°C	35°C	24°C	ISO15042-T1
Heating	20°C	—	7°C	6°C	ISO15042-H1

(2) This air-conditioner is manufactured and tested in conformity with the ISO.

(3) Sound level indicates the value in an anechoic chamber.

During operation these values are somewhat higher due to ambient conditions.

(4) The difference in appearance color is as follows.

Item	Model	SRK50ZSX-WB	SRK50ZSX-WT
Exterior appearance (Equivalent color)		Fine snow (8.0Y 9.3 / 0.1) , RAL : 9003 Black (4.0PB 2.44 / 0.25) , RAL : 9011	Titanium gray (1.6Y 6.59 / 0.63) , RAL : 7048 Black (4.0PB 2.44 / 0.25) , RAL : 9011

Adapted to **RoHS** directive

Item		Model	SRK60ZSX-W, -WB, -WT		
Power source			1 Phase, 220-240V, 50Hz / 220V, 60Hz		
Operation data	Nominal cooling capacity (range)	kW	6.0		
	Nominal heating capacity (range)	kW	6.8		
	Sound power level	Cooling	dB(A)	62	
		Heating		63	
	Sound pressure level	Cooling		Hi: 48 Me: 41 Lo: 33 ULo: 22	
		Heating		Hi: 47 Me: 42 Lo: 34 ULo: 23	
Silent mode sound pressure level		-			
Exterior dimensions (Height x Width x Depth)		mm		305 x 920 x 220	
Exterior appearance (4) (Equivalent color)			SRK60ZSX-W : Fine snow (8.0Y 9.3/0.1) , RAL : 9003		
Net weight		kg	13		
Heat exchanger			Louver fins & inner grooved tubing		
Fan type & Q'ty			Tangential fan x 1		
Fan motor (Starting method)		W	42 x1 (Direct drive)		
Air flow	Cooling	m ³ /min	Hi: 16.3 Me: 13.4 Lo: 8.9 ULo: 5.4		
	Heating		Hi: 17.8 Me: 13.7 Lo: 10.9 ULo: 6.2		
Available external static pressure		Pa	0		
Outside air intake			Not possible		
Air filter, Quality / Quantity			Polypropylene net (washable) x 2		
Shock & vibration absorber			Rubber sleeve (for fan motor)		
Operation control	Remote control		Wireless remote control		
	Room temperature control		Microcomputer thermostat		
	Operation display		RUN: Green, TIMER: Yellow, ECO: Blue		
Safety equipments			Frost protection, Serial signal error protection, Indoor fan motor error protection		
Installation data	Refrigerant piping size (O.D)	mm	Liquid line: ϕ 6.35 (1/4") Gas line: ϕ 12.7 (1/2")		
	Connecting method		Flare connection		
	Attached length of piping	m	Liquid line : 0.55 / Gas line : 0.48		
	Insulation for piping		Necessary (Both sides), independent		
	Drain hose		Hose connectable (VP16)		
Drain pump, max lift height		mm	-		
Interconnecting wires	Size x Core number		1.5mm ² x 4 cores (Including earth cable) / Terminal block (Screw fixing type)		
IP number			IPX0		
Standard accessories			Mounting kit, Clean filter (Allergen clear filter x 1, Photocatalytic washable deodorizing filter x 1)		
Option parts			Interface kit (SC-BIKN2-E)		

Notes (1) The data are measured at the following conditions.

The pipe length is 5m.

Operation \ Item	Indoor air temperature		Outdoor air temperature		Standards
	DB	WB	DB	WB	
Cooling	27°C	19°C	35°C	24°C	ISO15042-T1
Heating	20°C	-	7°C	6°C	ISO15042-H1

(2) This air-conditioner is manufactured and tested in conformity with the ISO.

(3) Sound level indicates the value in an anechoic chamber.

During operation these values are somewhat higher due to ambient conditions.

(4) The difference in appearance color is as follows.

Item	Model	SRK60ZSX-WB	SRK60ZSX-WT
Exterior appearance (Equivalent color)		Fine snow (8.0Y 9.3 / 0.1) , RAL : 9003 Black (4.0PB 2.44 / 0.25) , RAL : 9011	Titanium gray (1.6Y 6.59 / 0.63) , RAL : 7048 Black (4.0PB 2.44 / 0.25) , RAL : 9011

(b) Models SRK20, 25, 35, 50ZS-W, -WB, -WT

Adapted to **RoHS** directive

Item		Model	SRK20ZS-W, -WB, -WT	
Power source			1 Phase, 220–240V, 50Hz / 220V, 60Hz	
Operation data	Nominal cooling capacity (range)	kW	2.0	
	Nominal heating capacity (range)	kW	3.0	
	Sound power level	Cooling	dB(A)	48
		Heating		50
	Sound pressure level	Cooling		Hi: 34 Me: 25 Lo: 22 ULo: 19
Heating		Hi: 36 Me: 29 Lo: 23 ULo: 19		
Silent mode sound pressure level		—		
Exterior dimensions (Height x Width x Depth)		mm	290 x 870 x 230	
Exterior appearance (4) (Equivalent color)			SRK20ZS-W : Fine snow (8.0Y 9.3/0.1) , RAL : 9003	
Net weight		kg	9.5	
Heat exchanger			Louver fins & inner grooved tubing	
Fan type & Q'ty			Tangential fan x 1	
Fan motor (Starting method)		W	30 x1 (Direct drive)	
Air flow	Cooling	m ³ /min	Hi: 9.3 Me: 7.0 Lo: 5.9 ULo: 5.0	
	Heating		Hi: 10.0 Me: 8.5 Lo: 6.5 ULo: 5.9	
Available external static pressure		Pa	0	
Outside air intake			Not possible	
Air filter, Quality / Quantity			Polypropylene net (washable) x 2	
Shock & vibration absorber			Rubber sleeve (for fan motor)	
Operation control	Remote control		Wireless remote control	
	Room temperature control		Microcomputer thermostat	
	Operation display		RUN: Green, TIMER: Yellow	
Safety equipments			Frost protection, Serial signal error protection, Indoor fan motor error protection	
Installation data	Refrigerant piping size (O.D)	mm	Liquid line: ϕ 6.35 (1/4") Gas line: ϕ 9.52 (3/8")	
	Connecting method		Flare connection	
	Attached length of piping	m	Liquid line : 0.54 / Gas line : 0.47	
	Insulation for piping		Necessary (Both sides), independent	
Drain hose			Hose connectable (VP16)	
Drain pump, max lift height		mm	—	
Interconnecting wires	Size x Core number		1.5mm ² x 4 cores (Including earth cable) / Terminal block (Screw fixing type)	
IP number			IPX0	
Standard accessories			Mounting kit, Clean filter (Allergen clear filter x 1, Photocatalytic washable deodorizing filter x 1)	
Option parts			Interface kit (SC-BIKN2-E)	

Notes (1) The data are measured at the following conditions.

The pipe length is 5m.

Operation	Item	Indoor air temperature		Outdoor air temperature		Standards
		DB	WB	DB	WB	
Cooling		27°C	19°C	35°C	24°C	ISO15042-T1
Heating		20°C	—	7°C	6°C	ISO15042-H1

(2) This air-conditioner is manufactured and tested in conformity with the ISO.

(3) Sound level indicates the value in an anechoic chamber.

During operation these values are somewhat higher due to ambient conditions.

(4) The difference in appearance color is as follows.

Item	Model	SRK20ZS-WB	SRK20ZS-WT
Exterior appearance (Equivalent color)		Fine snow (8.0Y 9.3 / 0.1) , RAL : 9003 Black (4.0PB 2.44 / 0.25) , RAL : 9011	Titanium gray (1.6Y 6.59 / 0.63) , RAL : 7048 Black (4.0PB 2.44 / 0.25) , RAL : 9011

Adapted to RoHS directive

Item		Model	SRK25ZS-W, -WB, -WT	
Power source			1 Phase, 220-240V, 50Hz / 220V, 60Hz	
Operation data	Nominal cooling capacity (range)	kW	2.5	
	Nominal heating capacity (range)	kW	3.4	
	Sound power level	Cooling	dB(A)	50
		Heating		53
	Sound pressure level	Cooling		Hi: 36 Me: 28 Lo: 23 ULo: 19
Heating		Hi: 39 Me: 30 Lo: 24 ULo: 19		
Silent mode sound pressure level		—		
Exterior dimensions (Height x Width x Depth)		mm	290 x 870 x 230	
Exterior appearance (4) (Equivalent color)			SRK25ZS-W : Fine snow (8.0Y 9.3/0.1) , RAL : 9003	
Net weight		kg	9.5	
Heat exchanger			Louver fins & inner grooved tubing	
Fan type & Q'ty			Tangential fan x 1	
Fan motor (Starting method)		W	30 x1 (Direct drive)	
Air flow	Cooling	m ³ /min	Hi: 9.9 Me: 8.0 Lo: 5.9 ULo: 5.0	
	Heating		Hi: 11.3 Me: 8.7 Lo: 6.7 ULo: 5.9	
Available external static pressure		Pa	0	
Outside air intake			Not possible	
Air filter, Quality / Quantity			Polypropylene net (washable) x 2	
Shock & vibration absorber			Rubber sleeve (for fan motor)	
Operation control	Remote control		Wireless remote control	
	Room temperature control		Microcomputer thermostat	
	Operation display		RUN: Green, TIMER: Yellow	
Safety equipments			Frost protection, Serial signal error protection, Indoor fan motor error protection	
Installation data	Refrigerant piping size (O.D)	mm	Liquid line: ϕ 6.35 (1/4") Gas line: ϕ 9.52 (3/8")	
	Connecting method		Flare connection	
	Attached length of piping	m	Liquid line : 0.54 / Gas line : 0.47	
	Insulation for piping		Necessary (Both sides), independent	
Drain hose			Hose connectable (VP16)	
Drain pump, max lift height		mm	—	
Interconnecting wires	Size x Core number		1.5mm ² x 4 cores (Including earth cable) / Terminal block (Screw fixing type)	
IP number			IPX0	
Standard accessories			Mounting kit, Clean filter (Allergen clear filter x 1, Photocatalytic washable deodorizing filter x 1)	
Option parts			Interface kit (SC-BIKN2-E)	

Notes (1) The data are measured at the following conditions.

The pipe length is 5m.

Operation	Item	Indoor air temperature		Outdoor air temperature		Standards
		DB	WB	DB	WB	
Cooling		27°C	19°C	35°C	24°C	ISO15042-T1
Heating		20°C	—	7°C	6°C	ISO15042-H1

(2) This air-conditioner is manufactured and tested in conformity with the ISO.

(3) Sound level indicates the value in an anechoic chamber.

During operation these values are somewhat higher due to ambient conditions.

(4) The difference in appearance color is as follows.

Item	Model	SRK25ZS-WB	SRK25ZS-WT
Exterior appearance (Equivalent color)		Fine snow (8.0Y 9.3 / 0.1) , RAL : 9003 Black (4.0PB 2.44 / 0.25) , RAL : 9011	Titanium gray (1.6Y 6.59 / 0.63) , RAL :7048 Black (4.0PB 2.44 / 0.25) , RAL : 9011

Adapted to **RoHS** directive

Item		Model	SRK35ZS-W, -WB, -WT	
Power source			1 Phase, 220-240V, 50Hz / 220V, 60Hz	
Operation data	Nominal cooling capacity (range)	kW	3.5	
	Nominal heating capacity (range)	kW	4.5	
	Sound power level	Cooling	dB(A)	54
		Heating		56
	Sound pressure level	Cooling		Hi: 40 Me: 30 Lo: 26 ULo: 19
		Heating		Hi: 41 Me: 36 Lo: 25 ULo: 19
Silent mode sound pressure level		—		
Exterior dimensions (Height x Width x Depth)		mm		290 x 870 x 230
Exterior appearance (4) (Equivalent color)			SRK35ZS-W : Fine snow (8.0Y 9.3/0.1) , RAL : 9003	
Net weight		kg	9.5	
Heat exchanger			Louver fins & inner grooved tubing	
Fan type & Q'ty			Tangential fan x 1	
Fan motor (Starting method)		W	30 x1 (Direct drive)	
Air flow	Cooling	m ³ /min	Hi: 11.3 Me: 8.7 Lo: 7.0 ULo: 5.0	
	Heating		Hi: 12.3 Me: 11.0 Lo: 7.0 ULo: 5.6	
Available external static pressure		Pa	0	
Outside air intake			Not possible	
Air filter, Quality / Quantity			Polypropylene net (washable) x 2	
Shock & vibration absorber			Rubber sleeve (for fan motor)	
Operation control	Remote control		Wireless remote control	
	Room temperature control		Microcomputer thermostat	
	Operation display		RUN: Green, TIMER: Yellow	
Safety equipments			Frost protection, Serial signal error protection, Indoor fan motor error protection	
Installation data	Refrigerant piping size (O.D)	mm	Liquid line: ϕ 6.35 (1/4") Gas line: ϕ 9.52 (3/8")	
	Connecting method		Flare connection	
	Attached length of piping	m	Liquid line : 0.54 / Gas line : 0.47	
	Insulation for piping		Necessary (Both sides), independent	
	Drain hose		Hose connectable (VP16)	
Drain pump, max lift height		mm	—	
Interconnecting wires	Size x Core number		1.5mm ² x 4 cores (Including earth cable) / Terminal block (Screw fixing type)	
IP number			IPX0	
Standard accessories			Mounting kit, Clean filter (Allergen clear filter x 1, Photocatalytic washable deodorizing filter x 1)	
Option parts			Interface kit (SC-BIKN2-E)	

Notes (1) The data are measured at the following conditions.

The pipe length is 5m.

Operation	Item	Indoor air temperature		Outdoor air temperature		Standards
		DB	WB	DB	WB	
Cooling		27°C	19°C	35°C	24°C	ISO15042-T1
Heating		20°C	—	7°C	6°C	ISO15042-H1

(2) This air-conditioner is manufactured and tested in conformity with the ISO.

(3) Sound level indicates the value in an anechoic chamber.

During operation these values are somewhat higher due to ambient conditions.

(4) The difference in appearance color is as follows.

Item	Model	SRK35ZS-WB	SRK35ZS-WT
Exterior appearance (Equivalent color)		Fine snow (8.0Y 9.3 / 0.1) , RAL : 9003 Black (4.0PB 2.44 / 0.25) , RAL : 9011	Titanium gray (1.6Y 6.59 / 0.63) , RAL : 7048 Black (4.0PB 2.44 / 0.25) , RAL : 9011

Adapted to **RoHS** directive

Item		Model	SRK50ZS-W, -WB, -WT	
Power source			1 Phase, 220-240V, 50Hz / 220V, 60Hz	
Operation data	Nominal cooling capacity (range)	kW	5.0	
	Nominal heating capacity (range)	kW	5.8	
	Sound power level	Cooling	dB(A)	59
		Heating		60
	Sound pressure level	Cooling		Hi: 46 Me: 36 Lo: 29 ULo: 22
		Heating		Hi: 46 Me: 37 Lo: 31 ULo: 24
Silent mode sound pressure level		—		
Exterior dimensions (Height x Width x Depth)		mm		290 x 870 x 230
Exterior appearance (4) (Equivalent color)			SRK50ZS-W : Fine snow (8.0Y 9.3/0.1) , RAL : 9003	
Net weight		kg	10.0	
Heat exchanger			Louver fins & inner grooved tubing	
Fan type & Q'ty			Tangential fan x 1	
Fan motor (Starting method)		W	42 x1 (Direct drive)	
Air flow	Cooling	m ³ /min	Hi: 12.1 Me: 9.9 Lo: 7.4 ULo: 5.9	
	Heating		Hi: 13.9 Me: 11.2 Lo: 9.1 ULo: 7.4	
Available external static pressure		Pa	0	
Outside air intake			Not possible	
Air filter, Quality / Quantity			Polypropylene net (washable) x 2	
Shock & vibration absorber			Rubber sleeve (for fan motor)	
Operation control	Remote control		Wireless remote control	
	Room temperature control		Microcomputer thermostat	
	Operation display		RUN: Green, TIMER: Yellow	
Safety equipments			Frost protection, Serial signal error protection, Indoor fan motor error protection	
Installation data	Refrigerant piping size (O.D)	mm	Liquid line: ϕ 6.35 (1/4") Gas line: ϕ 12.7 (1/2")	
	Connecting method		Flare connection	
	Attached length of piping	m	Liquid line : 0.54 / Gas line : 0.47	
	Insulation for piping		Necessary (Both sides), independent	
	Drain hose		Hose connectable (VP16)	
Drain pump, max lift height		mm	—	
Interconnecting wires	Size x Core number		1.5mm ² x 4 cores (Including earth cable) / Terminal block (Screw fixing type)	
IP number			IPX0	
Standard accessories			Mounting kit, Clean filter (Allergen clear filter x 1, Photocatalytic washable deodorizing filter x 1)	
Option parts			Interface kit (SC-BIKN2-E)	

Notes (1) The data are measured at the following conditions.

The pipe length is 5m.

Operation	Item	Indoor air temperature		Outdoor air temperature		Standards
		DB	WB	DB	WB	
Cooling		27°C	19°C	35°C	24°C	ISO15042-T1
Heating		20°C	—	7°C	6°C	ISO15042-H1

(2) This air-conditioner is manufactured and tested in conformity with the ISO.

(3) Sound level indicates the value in an anechoic chamber.

During operation these values are somewhat higher due to ambient conditions.

(4) The difference in appearance color is as follows.

Item	Model	SRK50ZS-WB	SRK50ZS-WT
Exterior appearance (Equivalent color)		Fine snow (8.0Y 9.3 / 0.1) , RAL : 9003 Black (4.0PB 2.44 / 0.25) , RAL : 9011	Titanium gray (1.6Y 6.59 / 0.63) , RAL : 7048 Black (4.0PB 2.44 / 0.25) , RAL : 9011

(c) Models SRK71, 80ZR-W

Adapted to RoHS directive

Item		Model	SRK71ZR-W	
Power source			1 Phase, 220–240V, 50Hz / 220V, 60Hz	
Operation data	Nominal cooling capacity (range)	kW	7.1	
	Nominal heating capacity (range)	kW	8.0	
	Sound power level	Cooling	dB(A)	57
		Heating		60
	Sound pressure level	Cooling		Hi: 44 Me: 41 Lo: 37 ULo: 25
Heating		Hi: 46 Me: 39 Lo: 35 ULo: 28		
Silent mode sound pressure level		—		
Exterior dimensions (Height x Width x Depth)		mm	339 x 1197 x 262	
Exterior appearance (Equivalent color)			Fine snow (8.0Y 9.3/0.1) , RAL : 9003	
Net weight		kg	15.5	
Heat exchanger			Louver fins & inner grooved tubing	
Fan type & Q'ty			Tangential fan x 1	
Fan motor (Starting method)		W	56 x1 (Direct drive)	
Air flow	Cooling	m ³ /min	Hi: 20.5 Me: 18.6 Lo: 16.2 ULo: 10.4	
	Heating		Hi: 25.0 Me: 19.8 Lo: 17.3 ULo: 13.3	
Available external static pressure		Pa	0	
Outside air intake			Not possible	
Air filter, Quality / Quantity			Polypropylene net (washable) x 2	
Shock & vibration absorber			Rubber sleeve (for fan motor)	
Operation control	Remote control		Wireless remote control	
	Room temperature control		Microcomputer thermostat	
	Operation display		RUN: Green, TIMER: Yellow, HI POWER: Green, 3D AUTO: Green	
Safety equipments			Frost protection, Serial signal error protection, Indoor fan motor error protection	
Installation data	Refrigerant piping size (O.D)	mm	Liquid line: ϕ 6.35 (1/4") Gas line: ϕ 15.88 (5/8")	
	Connecting method		Flare connection	
	Attached length of piping	m	Liquid line : 0.78 / Gas line : 0.72	
	Insulation for piping		Necessary (Both sides), independent	
Drain hose			Hose connectable (VP16)	
Drain pump, max lift height		mm	—	
Interconnecting wires	Size x Core number		1.5mm ² x 4 cores (Including earth cable) / Terminal block (Screw fixing type)	
IP number			IPX0	
Standard accessories			Mounting kit, Clean filter (Allergen clear filter x 1, Photocatalytic washable deodorizing filter x 1)	
Option parts			Interface kit (SC-BIKN2-E)	

Notes (1) The data are measured at the following conditions.

The pipe length is 5m.

Operation	Item	Indoor air temperature		Outdoor air temperature		Standards
		DB	WB	DB	WB	
Cooling		27°C	19°C	35°C	24°C	ISO15042-T1
Heating		20°C	—	7°C	6°C	ISO15042-H1

(2) This air-conditioner is manufactured and tested in conformity with the ISO.

(3) Sound level indicates the value in an anechoic chamber.

During operation these values are somewhat higher due to ambient conditions.

Adapted to **RoHS** directive

Item		Model	SRK80ZR-W	
Power source			1 Phase, 220–240V, 50Hz / 220V, 60Hz	
Operation data	Nominal cooling capacity (range)	kW	8.0	
	Nominal heating capacity (range)	kW	9.0	
	Sound power level	Cooling	dB(A)	60
		Heating		62
	Sound pressure level	Cooling		Hi: 47 Me: 44 Lo: 39 ULo: 26
Heating		Hi: 47 Me: 41 Lo: 36 ULo: 29		
Silent mode sound pressure level		—		
Exterior dimensions (Height x Width x Depth)		mm	339 x 1197 x 262	
Exterior appearance (Equivalent color)			Fine snow (8.0Y 9.3/0.1) , RAL : 9003	
Net weight		kg	16.5	
Heat exchanger			Louver fins & inner grooved tubing	
Fan type & Q'ty			Tangential fan x 1	
Fan motor (Starting method)		W	56 x1 (Direct drive)	
Air flow	Cooling	m ³ /min	Hi: 23.5 Me: 20.2 Lo: 17.5 ULo: 10.4	
	Heating		Hi: 26.5 Me: 21.3 Lo: 18.4 ULo: 13.5	
Available external static pressure		Pa	0	
Outside air intake			Not possible	
Air filter, Quality / Quantity			Polypropylene net (washable) x 2	
Shock & vibration absorber			Rubber sleeve (for fan motor)	
Operation control	Remote control		Wireless remote control	
	Room temperature control		Microcomputer thermostat	
	Operation display		RUN: Green, TIMER: Yellow, HI POWER: Green, 3D AUTO: Green	
Safety equipments			Frost protection, Serial signal error protection, Indoor fan motor error protection	
Installation data	Refrigerant piping size (O.D)	mm	Liquid line: ϕ 6.35 (1/4") Gas line: ϕ 15.88 (5/8")	
	Connecting method		Flare connection	
	Attached length of piping	m	Liquid line : 0.78 / Gas line : 0.72	
	Insulation for piping		Necessary (Both sides), independent	
Drain hose			Hose connectable (VP16)	
Drain pump, max lift height		mm	—	
Interconnecting wires	Size x Core number		1.5mm ² x 4 cores (Including earth cable) / Terminal block (Screw fixing type)	
IP number			IPX0	
Standard accessories			Mounting kit, Clean filter (Allergen clear filter x 1, Photocatalytic washable deodorizing filter x 1)	
Option parts			Interface kit (SC-BIKN2-E)	

Notes (1) The data are measured at the following conditions.

The pipe length is 5m.

Operation	Item	Indoor air temperature		Outdoor air temperature		Standards
		DB	WB	DB	WB	
Cooling		27°C	19°C	35°C	24°C	ISO15042-T1
Heating		20°C	—	7°C	6°C	ISO15042-H1

(2) This air-conditioner is manufactured and tested in conformity with the ISO.

(3) Sound level indicates the value in an anechoic chamber.

During operation these values are somewhat higher due to ambient conditions.

(d) Models SKM20, 25, 35ZSP-W

Item		Model	SKM20ZSP-W			
Power source			1 Phase, 220-240V, 50Hz / 220V, 60Hz			
Operation data	Nominal cooling capacity	kW	2.0			
	Nominal heating capacity	kW	3.0			
	Sound power level	Cooling	dB(A)	57		
		Heating		56		
	Sound pressure level	Cooling		Hi: 42 Me: 35 Lo: 22		
		Heating		Hi: 41 Me: 36 Lo: 26		
Silent mode sound pressure level		-				
Exterior dimensions (Height x Width x Depth)		mm		267 x 783 x 210		
Exterior appearance (Equivalent color)			Fine snow (8.0Y 9.3/0.1) , RAL : 9003			
Net weight		kg	7.5			
Heat exchanger			Louver fins & inner grooved tubing			
Fan type & Q'ty			Tangential fan x 1			
Fan motor (Starting method)		W	30 x1 (Direct drive)			
Air flow	Cooling	m ³ /min	Hi: 8.5 Me: 7.0 Lo: 5.0			
	Heating		Hi: 8.0 Me: 7.0 Lo: 5.5			
Available external static pressure		Pa	0			
Outside air intake			Not possible			
Air filter, Quality / Quantity			Polypropylene net (washable)			
Shock & vibration absorber			Rubber sleeve (for fan motor)			
Operation control	Remote control		Wireless remote control			
	Room temperature control		Microcomputer thermostat			
	Operation display		RUN: Green , TIMER: Yellow			
Safety equipments			Frost protection, Serial signal error protection, Indoor fan motor error protection			
Installation data	Refrigerant piping size (O.D)	mm	Liquid line: ϕ 6.35 (1/4") Gas line: ϕ 9.52 (3/8")			
	Connecting method		Flare connection			
	Attached length of piping	m	Liquid line : 0.46 / Gas line : 0.39			
	Insulation for piping		Necessary (Both sides), independent			
Drain hose			Hose connectable (VP16)			
Drain pump, max lift height		mm	-			
Interconnecting wires	Size x Core number		1.5mm ² x 4 cores (Including earth cable) / Terminal block (Screw fixing type)			
IP number			IPX0			
Standard accessories			Mounting kit			
Option parts			-			
Notes (1) The data are measured at the following conditions.			The pipe length is 5m.			
Operation	Item	Indoor air temperature		Outdoor air temperature		Standards
		DB	WB	DB	WB	
	Cooling	27°C	19°C	35°C	24°C	
Heating	20°C	-	7°C	6°C	ISO15042-H1	
(2) This air-conditioner is manufactured and tested in conformity with the ISO.						
(3) Sound level indicates the value in an anechoic chamber.						
During operation these values are somewhat higher due to ambient conditions.						

Item		Model	SKM25ZSP-W		
Power source			1 Phase, 220-240V, 50Hz / 220V, 60Hz		
Operation data	Nominal cooling capacity (range)	kW	2.5		
	Nominal heating capacity (range)	kW	3.4		
	Sound power level	Cooling	dB(A)	57	
		Heating		56	
	Sound pressure level	Cooling		Hi: 43 Me: 36 Lo: 23	
		Heating		Hi: 41 Me: 36 Lo: 27	
Silent mode sound pressure level		-			
Exterior dimensions (Height x Width x Depth)		mm		267 x 783 x 210	
Exterior appearance (Equivalent color)			Fine snow (8.0Y 9.3/0.1) , RAL : 9003		
Net weight		kg	7.5		
Heat exchanger			Louver fins & inner grooved tubing		
Fan type & Q'ty			Tangential fan x 1		
Fan motor (Starting method)		W	30 x1 (Direct drive)		
Air flow	Cooling	m ³ /min	Hi: 8.5 Me: 7.0 Lo: 5.0		
	Heating		Hi: 8.0 Me: 7.0 Lo: 5.5		
Available external static pressure		Pa	0		
Outside air intake			Not possible		
Air filter, Quality / Quantity			Polypropylene net (washable)		
Shock & vibration absorber			Rubber sleeve (for fan motor)		
Operation control	Remote control		Wireless remote control		
	Room temperature control		Microcomputer thermostat		
	Operation display		RUN: Green , TIMER: Yellow		
Safety equipments			Frost protection, Serial signal error protection, Indoor fan motor error protection		
Installation data	Refrigerant piping size (O.D)	mm	Liquid line: ϕ 6.35 (1/4") Gas line: ϕ 9.52 (3/8")		
	Connecting method		Flare connection		
	Attached length of piping	m	Liquid line : 0.46 / Gas line : 0.39		
	Insulation for piping		Necessary (Both sides), independent		
Drain hose			Hose connectable (VP16)		
Drain pump, max lift height		mm	-		
Interconnecting wires	Size x Core number		1.5mm ² x 4 cores (Including earth cable) / Terminal block (Screw fixing type)		
IP number			IPX0		
Standard accessories			Mounting kit		
Option parts			-		

Notes (1) The data are measured at the following conditions. The pipe length is 5m.

Operation \ Item	Indoor air temperature		Outdoor air temperature		Standards
	DB	WB	DB	WB	
Cooling	27°C	19°C	35°C	24°C	ISO15042-T1
Heating	20°C	-	7°C	6°C	ISO15042-H1

(2) This air-conditioner is manufactured and tested in conformity with the ISO.

(3) Sound level indicates the value in an anechoic chamber.

During operation these values are somewhat higher due to ambient conditions.

Item		Model	SKM35ZSP-W		
Power source			1 Phase, 220-240V, 50Hz / 220V, 60Hz		
Operation data	Nominal cooling capacity (range)	kW	3.5		
	Nominal heating capacity (range)	kW	4.5		
	Sound power level	Cooling	dB(A)	58	
		Heating		58	
	Sound pressure level	Cooling		Hi: 44 Me: 37 Lo: 25	
		Heating		Hi: 42 Me: 37 Lo: 30	
Silent mode sound pressure level		-			
Exterior dimensions (Height x Width x Depth)		mm		267 x 783 x 210	
Exterior appearance (Equivalent color)			Fine snow (8.0Y 9.3/0.1) , RAL : 9003		
Net weight		kg	7.5		
Heat exchanger			Louver fins & inner grooved tubing		
Fan type & Q'ty			Tangential fan x 1		
Fan motor (Starting method)		W	30 x1 (Direct drive)		
Air flow	Cooling	m ³ /min	Hi: 9.0 Me: 7.5 Lo: 5.0		
	Heating		Hi: 8.5 Me: 7.0 Lo: 6.0		
Available external static pressure		Pa	0		
Outside air intake			Not possible		
Air filter, Quality / Quantity			Polypropylene net (washable)		
Shock & vibration absorber			Rubber sleeve (for fan motor)		
Operation control	Remote control		Wireless remote control		
	Room temperature control		Microcomputer thermostat		
	Operation display		RUN: Green , TIMER: Yellow		
Safety equipments			Frost protection, Serial signal error protection, Indoor fan motor error protection		
Installation data	Refrigerant piping size (O.D)	mm	Liquid line: ϕ 6.35 (1/4") Gas line: ϕ 9.52 (3/8")		
	Connecting method		Flare connection		
	Attached length of piping	m	Liquid line : 0.46 / Gas line : 0.39		
	Insulation for piping		Necessary (Both sides), independent		
Drain hose			Hose connectable (VP16)		
Drain pump, max lift height		mm	-		
Interconnecting wires	Size x Core number		1.5mm ² x 4 cores (Including earth cable) / Terminal block (Screw fixing type)		
IP number			IPX0		
Standard accessories			Mounting kit		
Option parts			-		

Notes (1) The data are measured at the following conditions.

The pipe length is 5m.

Operation	Item	Indoor air temperature		Outdoor air temperature		Standards
		DB	WB	DB	WB	
Cooling		27°C	19°C	35°C	24°C	ISO15042-T1
Heating		20°C	-	7°C	6°C	ISO15042-H1

(2) This air-conditioner is manufactured and tested in conformity with the ISO.

(3) Sound level indicates the value in an anechoic chamber.

During operation these values are somewhat higher due to ambient conditions.

(2) Floor standing type (SRF)
Models SRF25, 35ZS-W, 50ZSX-W

Adapted to **RoHS** directive

Item		Model	SRF25ZS-W	
Power source			1 Phase, 220-240V, 50Hz / 220V, 60Hz	
Operation data	Nominal cooling capacity (range)	kW	2.5	
	Nominal heating capacity (range)	kW	3.4	
	Sound power level	Cooling	dB(A)	50
		Heating		51
	Sound pressure level	Cooling		Hi: 38 Me: 32 Lo: 29 ULo: 25
		Heating		Hi: 39 Me: 35 Lo: 33 ULo: 29
Silent mode sound pressure level		—		
Exterior dimensions (Height x Width x Depth)		mm		600 x 860 x 238
Exterior appearance (Munsell color)			Fine snow (8.0Y 9.3/0.1), RAL : 9003	
Net weight		kg	18	
Heat exchanger			Louver fins & inner grooved tubing	
Fan type & Q'ty			Turbo fan x 1	
Fan motor (Starting method)		W	40 x1 (Direct drive)	
Air flow	Cooling	m ³ /min	Hi: 9.0 Me: 7.6 Lo: 6.7 ULo: 5.8	
	Heating		Hi: 10.5 Me: 8.2 Lo: 7.7 ULo: 6.6	
Available external static pressure		Pa	0	
Outside air intake			Not possible	
Air filter, Quality / Quantity			Polypropylene net (washable) x 1	
Shock & vibration absorber			Rubber sleeve (for fan motor)	
Operation control	Remote control		Wireless remote control	
	Room temperature control		Microcomputer thermostat	
	Operation display		RUN: Green, TIMER: Yellow, HI POWER: Green, Air outlet selection: Green, ECONO: Green	
Safety equipments			Frost protection, Serial signal error protection, Indoor fan motor error protection	
Installation data	Refrigerant piping size (O.D)	mm	Liquid line: ϕ 6.35 (1/4") Gas line: ϕ 9.52 (3/8")	
	Connecting method		Flare connection	
	Attached length of piping	m	—	
	Insulation for piping		Necessary (Both sides), independent	
Drain hose			Hose connectable (VP16)	
Drain pump, max lift height		mm	—	
Interconnecting wires	Size x Core number		1.5mm ² x 4 cores (Including earth cable) / Terminal block (Screw fixing type)	
IP number			IPX0	
Standard accessories			Mounting kit, Clean filter (Allergen clear filter x 1, Photocatalytic washable deodorizing filter x 1)	
Option parts			Interface kit (SC-BIKN2-E)	

Notes (1) The data are measured at the following conditions.

The pipe length is 5m.

Operation	Item	Indoor air temperature		Outdoor air temperature		Standards
		DB	WB	DB	WB	
Cooling		27°C	19°C	35°C	24°C	ISO15042-T1
Heating		20°C	—	7°C	6°C	ISO15042-H1

(2) This air-conditioner is manufactured and tested in conformity with the ISO.

(3) Sound level indicates the value in an anechoic chamber.

During operation these values are somewhat higher due to ambient conditions.

Adapted to **RoHS** directive

Item		Model	SRF35ZS-W	
Power source			1 Phase, 220-240V, 50Hz / 220V, 60Hz	
Operation data	Nominal cooling capacity (range)	kW	3.5	
	Nominal heating capacity (range)	kW	4.5	
	Sound power level	Cooling	dB(A)	51
		Heating		52
	Sound pressure level	Cooling		Hi: 40 Me: 35 Lo: 33 ULo: 29
		Heating		Hi: 41 Me: 36 Lo: 35 ULo: 33
Silent mode sound pressure level		—		
Exterior dimensions (Height x Width x Depth)		mm		600 x 860 x 238
Exterior appearance (Munsell color)			Fine snow (8.0Y 9.3/0.1), RAL : 9003	
Net weight		kg	19	
Heat exchanger			Louver fins & inner grooved tubing	
Fan type & Q'ty			Turbo fan x 1	
Fan motor (Starting method)		W	40 x1 (Direct drive)	
Air flow	Cooling	m ³ /min	Hi: 9.2 Me: 7.8 Lo: 7.3 ULo: 6.4	
	Heating		Hi: 10.7 Me: 8.3 Lo: 8.1 ULo: 7.4	
Available external static pressure		Pa	0	
Outside air intake			Not possible	
Air filter, Quality / Quantity			Polypropylene net (washable) x 1	
Shock & vibration absorber			Rubber sleeve (for fan motor)	
Operation control	Remote control		Wireless remote control	
	Room temperature control		Microcomputer thermostat	
	Operation display		RUN: Green, TIMER: Yellow, HI POWER: Green, Air outlet selection: Green, ECONO: Green	
Safety equipments			Frost protection, Serial signal error protection, Indoor fan motor error protection	
Installation data	Refrigerant piping size (O.D)	mm	Liquid line: ϕ 6.35 (1/4") Gas line: ϕ 9.52 (3/8")	
	Connecting method		Flare connection	
	Attached length of piping	m	—	
	Insulation for piping		Necessary (Both sides), independent	
Drain hose			Hose connectable (VP16)	
Drain pump, max lift height		mm	—	
Interconnecting wires	Size x Core number		1.5mm ² x 4 cores (Including earth cable) / Terminal block (Screw fixing type)	
IP number			IPX0	
Standard accessories			Mounting kit, Clean filter (Allergen clear filter x 1, Photocatalytic washable deodorizing filter x 1)	
Option parts			Interface kit (SC-BIKN2-E)	

Notes (1) The data are measured at the following conditions.

The pipe length is 5m.

Operation	Item	Indoor air temperature		Outdoor air temperature		Standards
		DB	WB	DB	WB	
Cooling		27°C	19°C	35°C	24°C	ISO15042-T1
Heating		20°C	—	7°C	6°C	ISO15042-H1

(2) This air-conditioner is manufactured and tested in conformity with the ISO.

(3) Sound level indicates the value in an anechoic chamber.

During operation these values are somewhat higher due to ambient conditions.

Adapted to **RoHS** directive

Item		Model	SRF50ZSX-W	
Power source			1 Phase, 220-240V, 50Hz / 220V, 60Hz	
Operation data	Nominal cooling capacity (range)	kW	5.0	
	Nominal heating capacity (range)	kW	5.8	
	Sound power level	Cooling	dB(A)	58
		Heating		58
	Sound pressure level	Cooling		Hi: 46 Me: 38 Lo: 33 ULo: 28
		Heating		Hi: 46 Me: 41 Lo: 38 ULo: 32
Silent mode sound pressure level		—		
Exterior dimensions (Height x Width x Depth)		mm		600 x 860 x 238
Exterior appearance (Munsell color)			Fine snow (8.0Y 9.3/0.1), RAL : 9003	
Net weight		kg	19	
Heat exchanger			Louver fins & inner grooved tubing	
Fan type & Q'ty			Turbo fan x 1	
Fan motor (Starting method)		W	40 x1 (Direct drive)	
Air flow	Cooling	m ³ /min	Hi: 11.5 Me: 9.6 Lo: 7.4 ULo: 6.6	
	Heating		Hi: 12.0 Me: 10.0 Lo: 9.4 ULo: 7.6	
Available external static pressure		Pa	0	
Outside air intake			Not possible	
Air filter, Quality / Quantity			Polypropylene net (washable) x 1	
Shock & vibration absorber			Rubber sleeve (for fan motor)	
Operation control	Remote control		Wireless remote control	
	Room temperature control		Microcomputer thermostat	
	Operation display		RUN: Green, TIMER: Yellow, HI POWER: Green, Air outlet selection: Green, ECONO: Green	
Safety equipments			Frost protection, Serial signal error protection, Indoor fan motor error protection	
Installation data	Refrigerant piping size (O.D)	mm	Liquid line: ϕ 6.35 (1/4") Gas line: ϕ 12.7 (1/2")	
	Connecting method		Flare connection	
	Attached length of piping	m	—	
	Insulation for piping		Necessary (Both sides), independent	
	Drain hose		Hose connectable (VP16)	
Drain pump, max lift height		mm	—	
Interconnecting wires	Size x Core number		1.5mm ² x 4 cores (Including earth cable) / Terminal block (Screw fixing type)	
IP number			IPX0	
Standard accessories			Mounting kit, Clean filter (Allergen clear filter x 1, Photocatalytic washable deodorizing filter x 1)	
Option parts			Interface kit (SC-BIKN2-E)	

Notes (1) The data are measured at the following conditions.

The pipe length is 7.5m.

Operation	Item	Indoor air temperature		Outdoor air temperature		Standards
		DB	WB	DB	WB	
Cooling		27°C	19°C	35°C	24°C	ISO15042-T1
Heating		20°C	—	7°C	6°C	ISO15042-H1

(2) This air-conditioner is manufactured and tested in conformity with the ISO.

(3) Sound level indicates the value in an anechoic chamber.

During operation these values are somewhat higher due to ambient conditions.

(3) Ceiling concealed type (SRR)

(a) Models SRR25, 35ZM-W

Item		Model	SRR25ZM-W	
Power source			1 Phase, 220-240V, 50Hz / 220V, 60Hz	
Operation data	Nominal cooling capacity (range)	kW	2.5	
	Nominal heating capacity (range)	kW	3.4	
	Sound power level	Cooling		56
		Heating		59
	Sound pressure level ①	Cooling	dB(A)	Hi: 37 Me: 33 Lo: 30 ULo: 24
		Heating		Hi: 40 Me: 37 Lo: 34 ULo: 28
	Sound pressure level ②	Cooling		Hi: 31 Me: 28 Lo: 26 ULo: 21
		Heating		Hi: 33 Me: 30 Lo: 28 ULo: 23
	Sound pressure level ③	Cooling		Hi: 39 Me: 35 Lo: 32 ULo: 25
Heating		Hi: 44 Me: 41 Lo: 38 ULo: 31		
Silent mode sound pressure level				—
Exterior dimensions (Height x Width x Depth)		mm		200 x 750 x 500
Exterior appearance (Equivalent color)				—
Net weight		kg	20.5	
Heat exchanger			Louver fins & inner grooved tubing	
Fan type & Q'ty			Centrifugal fan x 2	
Fan motor (Starting method)		W	51 x1 (Direct drive)	
Air flow	Cooling	m ³ /min	Hi: 9.5 Me: 8.0 Lo: 6.5 ULo: 4.5	
	Heating		Hi: 10.0 Me: 9.0 Lo: 8.0 ULo: 6.0	
Available external static pressure		Pa	35 (Initial static pressure with air filter:5Pa)	
Outside air intake			Not possible	
Air filter, Quality / Quantity			Polypropylene net x 1	
Shock & vibration absorber			Cushion rubber (for fan motor)	
Operation control	Remote control		Wireless remote control	
	Room temperature control		Microcomputer thermostat	
	Operation display		RUN: Green, TIMER: Yellow, HI POWER: Green, ECONO: Green	
Safety equipments			Drain error protection, Frost protection, Serial signal error protection, Indoor fan motor error protection	
Installation data	Refrigerant piping size (O.D)	mm	Liquid line: ϕ 6.35 (1/4") Gas line: ϕ 9.52 (3/8")	
	Connecting method		Flare connection	
	Insulation for piping		Necessary (Both sides), independent	
	Drain hose		Hose connectable (VP25)	
Drain pump, max lift height		mm	Built-in, MAX600	
Interconnecting wires	Size x Core number		1.5mm ² x 4 cores (Including earth cable) / Terminal block (Screw fixing type)	
IP number			IPX0	
Standard accessories			Mounting kit, Joint for drain piping	
Option parts			Wired remote control, Interface kit (SC-BIKN2-E), Bottom air inlet kit	

Notes (1) The data are measured at the following conditions.

Operation \ Item	Indoor air temperature		Outdoor air temperature		Standards	Note
	DB	WB	DB	WB		
Cooling	27°C	19°C	35°C	24°C	ISO15042-T1	Non-duct (with air filter)
Heating	20°C	—	7°C	6°C	ISO15042-H1	

(2) This air-conditioner is manufactured and tested in conformity with the ISO.

(3) Sound level indicates the value in an anechoic chamber.

During operation these values are somewhat higher due to ambient conditions.

(4) Mike positions of measuring sound pressure level of indoor unit is shown below.

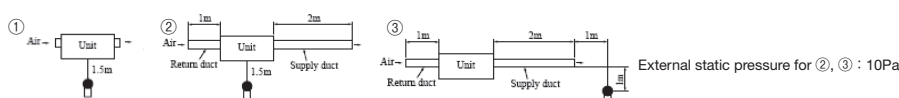

Item		Model	SRR35ZM-W		
Power source			1 Phase, 220-240V, 50Hz / 220V, 60Hz		
Operation data	Nominal cooling capacity (range)	kW	3.5		
	Nominal heating capacity (range)	kW	4.5		
	Sound power level	Cooling	dB(A)	57	
		Heating		60	
	Sound pressure level ①	Cooling		Hi: 38 Me: 34 Lo: 31 ULo: 25	
		Heating		Hi: 42 Me: 38 Lo: 35 ULo: 29	
	Sound pressure level ②	Cooling		Hi: 33 Me: 30 Lo: 27 ULo: 22	
		Heating		Hi: 34 Me: 32 Lo: 29 ULo: 24	
	Sound pressure level ③	Cooling		Hi: 40 Me: 37 Lo: 33 ULo: 27	
Heating		Hi: 45 Me: 42 Lo: 39 ULo: 33			
Silent mode sound pressure level				-	
Exterior dimensions (Height x Width x Depth)		mm	200 x 750 x 500		
Exterior appearance (Equivalent color)			-		
Net weight		kg	20.5		
Heat exchanger			Louver fins & inner grooved tubing		
Fan type & Q'ty			Centrifugal fan x 2		
Fan motor (Starting method)		W	51 x1 (Direct drive)		
Air flow	Cooling	m³/min	Hi: 10.0 Me: 8.5 Lo: 7.0 ULo: 5.0		
	Heating		Hi: 10.5 Me: 9.5 Lo: 8.5 ULo: 6.5		
Available external static pressure		Pa	35 (Initial static pressure with air filter:5Pa)		
Outside air intake			Not possible		
Air filter, Quality / Quantity			Polypropylene net x 1		
Shock & vibration absorber			Cushion rubber (for fan motor)		
Operation control	Remote control		Wireless remote control		
	Room temperature control		Microcomputer thermostat		
	Operation display		RUN: Green, TIMER: Yellow, HI POWER: Green, ECONO: Green		
Safety equipments			Drain error protection, Frost protection, Serial signal error protection, Indoor fan motor error protection		
Installation data	Refrigerant piping size (O.D)	mm	Liquid line: ϕ 6.35 (1/4") Gas line: ϕ 9.52 (3/8")		
	Connecting method		Flare connection		
	Insulation for piping		Necessary (Both sides), independent		
	Drain hose		Hose connectable (VP25)		
Drain pump, max lift height		mm	Built-in, MAX600		
Interconnecting wires	Size x Core number		1.5mm² x 4 cores (Including earth cable) / Terminal block (Screw fixing type)		
IP number			IPX0		
Standard accessories			Mounting kit, Joint for drain piping		
Option parts			Wired remote control, Interface kit (SC-BIKN2-E), Bottom air inlet kit		

Notes (1) The data are measured at the following conditions.

The pipe length is 5m.

Operation	Item	Indoor air temperature		Outdoor air temperature		Standards	Note
		DB	WB	DB	WB		
Cooling		27°C	19°C	35°C	24°C	ISO15042-T1	Non-duct (with air filter)
Heating		20°C	-	7°C	6°C	ISO15042-H1	

(2) This air-conditioner is manufactured and tested in conformity with the ISO.

(3) Sound level indicates the value in an anechoic chamber.

During operation these values are somewhat higher due to ambient conditions.

(4) Mike positions of measuring sound pressure level of indoor unit is shown below.

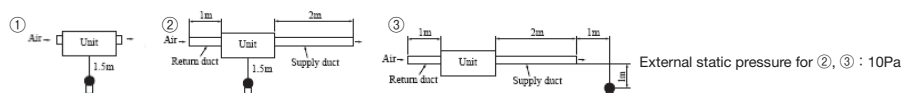

(b) Models SRR25, 35, 50, 60ZS-W

Item		Model	SRR25ZS-W	
Power source			1 Phase, 220-240V, 50Hz / 220V, 60Hz	
Operation data	Nominal cooling capacity (range)	kW	2.5	
	Nominal heating capacity (range)	kW	3.4	
	Sound power level	Cooling		56
		Heating		59
	Sound pressure level ①	Cooling	dB(A)	Hi: 37 Me: 33 Lo: 30 ULo: 24
		Heating		Hi: 40 Me: 37 Lo: 34 ULo: 28
	Sound pressure level ②	Cooling		Hi: 31 Me: 28 Lo: 26 ULo: 21
		Heating		Hi: 33 Me: 30 Lo: 28 ULo: 23
Sound pressure level ③	Cooling	Hi: 39 Me: 35 Lo: 32 ULo: 25		
	Heating	Hi: 44 Me: 41 Lo: 38 ULo: 31		
Silent mode sound pressure level				—
Exterior dimensions (Height x Width x Depth)		mm		200 x 750 x 500
Exterior appearance (Equivalent color)			—	
Net weight		kg	20.5	
Heat exchanger			Louver fins & inner grooved tubing	
Fan type & Q'ty			Centrifugal fan x 2	
Fan motor (Starting method)		W	51 x1 (Direct drive)	
Air flow	Cooling	m ³ /min	Hi: 9.5 Me: 8.0 Lo: 6.5 ULo: 4.5	
	Heating		Hi: 10.0 Me: 9.0 Lo: 8.0 ULo: 6.0	
Available external static pressure		Pa	35 (Initial static pressure with air filter:5Pa)	
Outside air intake			Not possible	
Air filter, Quality / Quantity			Polypropylene net x 1	
Shock & vibration absorber			Cushion rubber (for fan motor)	
Operation control	Remote control		Wireless remote control	
	Room temperature control		Microcomputer thermostat	
	Operation display		RUN: Green, TIMER: Yellow, HI POWER: Green, ECONO: Green	
Safety equipments			Drain error protection, Frost protection, Serial signal error protection, Indoor fan motor error protection	
Installation data	Refrigerant piping size (O.D)	mm	Liquid line: ϕ 6.35 (1/4") Gas line: ϕ 9.52 (3/8")	
	Connecting method		Flare connection	
	Insulation for piping		Necessary (Both sides), independent	
	Drain hose		Hose connectable (VP25)	
Drain pump, max lift height		mm	Built-in, MAX600	
Interconnecting wires	Size x Core number		1.5mm ² x 4 cores (Including earth cable) / Terminal block (Screw fixing type)	
IP number			IPX0	
Standard accessories			Mounting kit, Joint for drain piping	
Option parts			Wired remote control, Interface kit (SC-BIKN2-E), Bottom air inlet kit	

Notes (1) The data are measured at the following conditions.

Operation \ Item	Indoor air temperature		Outdoor air temperature		Standards	Note
	DB	WB	DB	WB		
Cooling	27°C	19°C	35°C	24°C	ISO15042-T1	Non-duct (with air filter)
Heating	20°C	—	7°C	6°C	ISO15042-H1	

(2) This air-conditioner is manufactured and tested in conformity with the ISO.

(3) Sound level indicates the value in an anechoic chamber.

During operation these values are somewhat higher due to ambient conditions.

(4) Mike positions of measuring sound pressure level of indoor unit is shown below.

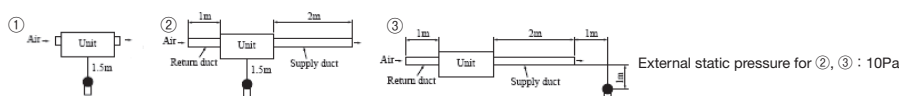

Item		Model	SRR35ZS-W		
Power source			1 Phase, 220-240V, 50Hz / 220V, 60Hz		
Operation data	Nominal cooling capacity (range)	kW	3.5		
	Nominal heating capacity (range)	kW	4.5		
	Sound power level	Cooling	dB(A)	57	
		Heating		60	
	Sound pressure level ①	Cooling		Hi: 38 Me: 34 Lo: 31 ULo: 25	
		Heating		Hi: 42 Me: 38 Lo: 35 ULo: 29	
	Sound pressure level ②	Cooling		Hi: 33 Me: 30 Lo: 27 ULo: 22	
		Heating		Hi: 34 Me: 32 Lo: 29 ULo: 24	
	Sound pressure level ③	Cooling		Hi: 40 Me: 37 Lo: 33 ULo: 27	
Heating		Hi: 45 Me: 42 Lo: 39 ULo: 33			
Silent mode sound pressure level				-	
Exterior dimensions (Height x Width x Depth)		mm	200 x 750 x 500		
Exterior appearance (Equivalent color)			-		
Net weight		kg	20.5		
Heat exchanger			Louver fins & inner grooved tubing		
Fan type & Q'ty			Centrifugal fan x 2		
Fan motor (Starting method)		W	51 x1 (Direct drive)		
Air flow	Cooling	m³/min	Hi: 10.0 Me: 8.5 Lo: 7.0 ULo: 5.0		
	Heating		Hi: 10.5 Me: 9.5 Lo: 8.5 ULo: 6.5		
Available external static pressure		Pa	35 (Initial static pressure with air filter:5Pa)		
Outside air intake			Not possible		
Air filter, Quality / Quantity			Polypropylene net x 1		
Shock & vibration absorber			Cushion rubber (for fan motor)		
Operation control	Remote control		Wireless remote control		
	Room temperature control		Microcomputer thermostat		
	Operation display		RUN: Green, TIMER: Yellow, HI POWER: Green, ECONO: Green		
Safety equipments			Drain error protection, Frost protection, Serial signal error protection, Indoor fan motor error protection		
Installation data	Refrigerant piping size (O.D)	mm	Liquid line: ϕ 6.35 (1/4") Gas line: ϕ 9.52 (3/8")		
	Connecting method		Flare connection		
	Insulation for piping		Necessary (Both sides), independent		
	Drain hose		Hose connectable (VP25)		
Drain pump, max lift height		mm	Built-in, MAX600		
Interconnecting wires	Size x Core number		1.5mm² x 4 cores (Including earth cable) / Terminal block (Screw fixing type)		
IP number			IPX0		
Standard accessories			Mounting kit, Joint for drain piping		
Option parts			Wired remote control, Interface kit (SC-BIKN2-E), Bottom air inlet kit		

Notes (1) The data are measured at the following conditions.

The pipe length is 5m.

Operation	Item	Indoor air temperature		Outdoor air temperature		Standards	Note
		DB	WB	DB	WB		
Cooling		27°C	19°C	35°C	24°C	ISO15042-T1	Non-duct (with air filter)
Heating		20°C	-	7°C	6°C	ISO15042-H1	

(2) This air-conditioner is manufactured and tested in conformity with the ISO.

(3) Sound level indicates the value in an anechoic chamber.

During operation these values are somewhat higher due to ambient conditions.

(4) Mike positions of measuring sound pressure level of indoor unit is shown below.

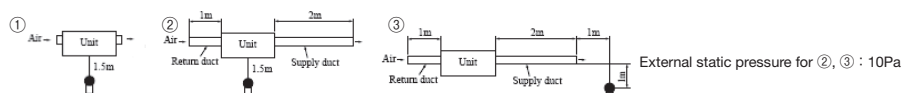

Item		Model	SRR50ZS-W		
Power source			1 Phase, 220-240V, 50Hz / 220V, 60Hz		
Operation data	Nominal cooling capacity (range)	kW	5.0		
	Nominal heating capacity (range)	kW	5.8		
	Sound power level	Cooling	dB(A)	59	
		Heating		61	
	Sound pressure level ①	Cooling		Hi: 41 Me: 37 Lo: 34 ULo: 29	
		Heating		Hi: 43 Me: 39 Lo: 37 ULo: 32	
	Sound pressure level ②	Cooling		Hi: 35 Me: 33 Lo: 30 ULo: 25	
		Heating		Hi: 38 Me: 36 Lo: 33 ULo: 28	
	Sound pressure level ③	Cooling		Hi: 41 Me: 37 Lo: 34 ULo: 29	
Heating		Hi: 46 Me: 43 Lo: 40 ULo: 34			
Silent mode sound pressure level				-	
Exterior dimensions (Height x Width x Depth)		mm	200 x 950 x 500		
Exterior appearance (Equivalent color)			-		
Net weight		kg	24		
Heat exchanger			Louver fins & inner grooved tubing		
Fan type & Q'ty			Centrifugal fan x 3		
Fan motor (Starting method)		W	85 x1 (Direct drive)		
Air flow	Cooling	m³/min	Hi: 13.5 Me: 11.0 Lo: 10.0 ULo: 7.5		
	Heating		Hi: 14.0 Me: 12.5 Lo: 11.0 ULo: 8.5		
Available external static pressure		Pa	50 (Initial static pressure with air filter:5Pa)		
Outside air intake			Not possible		
Air filter, Quality / Quantity			Polypropylene net x 1		
Shock & vibration absorber			Cushion rubber (for fan motor)		
Operation control	Remote control		Wireless remote control		
	Room temperature control		Microcomputer thermostat		
	Operation display		RUN: Green, TIMER: Yellow, HI POWER: Green, ECONO: Green		
Safety equipments			Drain error protection, Frost protection, Serial signal error protection, Indoor fan motor error protection		
Installation data	Refrigerant piping size (O.D)	mm	Liquid line: φ 6.35 (1/4") Gas line: φ 12.7 (1/2")		
	Connecting method		Flare connection		
	Insulation for piping		Necessary (Both sides), independent		
	Drain hose		Hose connectable (VP25)		
Drain pump, max lift height		mm	Built-in, MAX600		
Interconnecting wires	Size x Core number		1.5mm² x 4 cores (Including earth cable) / Terminal block (Screw fixing type)		
IP number			IPX0		
Standard accessories			Mounting kit, Joint for drain piping		
Option parts			Wired remote control, Interface kit (SC-BIKN2-E), Bottom air inlet kit		

Notes (1) The data are measured at the following conditions.

The pipe length is 5m.

Operation	Item	Indoor air temperature		Outdoor air temperature		Standards	Note
		DB	WB	DB	WB		
Cooling		27°C	19°C	35°C	24°C	ISO15042-T1	Non-duct (with air filter)
Heating		20°C	-	7°C	6°C	ISO15042-H1	

(2) This air-conditioner is manufactured and tested in conformity with the ISO.

(3) Sound level indicates the value in an anechoic chamber.

During operation these values are somewhat higher due to ambient conditions.

(4) Mike positions of measuring sound pressure level of indoor unit is shown below.

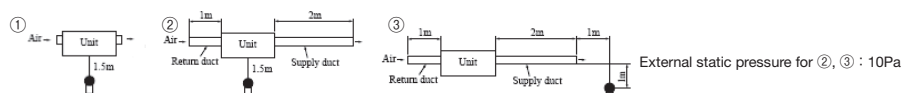

Item		Model	SRR60ZS-W		
Power source			1 Phase, 220-240V, 50Hz / 220V, 60Hz		
Operation data	Nominal cooling capacity (range)	kW	6.0		
	Nominal heating capacity (range)	kW	6.8		
	Sound power level	Cooling	dB(A)	60	
		Heating		63	
	Sound pressure level ①	Cooling		Hi: 44 Me: 38 Lo: 35 ULo: 30	
		Heating		Hi: 45 Me: 41 Lo: 38 ULo: 33	
	Sound pressure level ②	Cooling		Hi: 37 Me: 34 Lo: 32 ULo: 27	
		Heating		Hi: 39 Me: 37 Lo: 34 ULo: 29	
	Sound pressure level ③	Cooling		Hi: 42 Me: 39 Lo: 36 ULo: 30	
Heating		Hi: 47 Me: 44 Lo: 41 ULo: 35			
Silent mode sound pressure level				-	
Exterior dimensions (Height x Width x Depth)		mm	200 x 950 x 500		
Exterior appearance (Equivalent color)			-		
Net weight		kg	24		
Heat exchanger			Louver fins & inner grooved tubing		
Fan type & Q'ty			Centrifugal fan x 3		
Fan motor (Starting method)		W	85 x1 (Direct drive)		
Air flow	Cooling	m³/min	Hi: 14.5 Me: 11.5 Lo: 10.5 ULo: 8.0		
	Heating		Hi: 15.0 Me: 13.0 Lo: 11.5 ULo: 9.0		
Available external static pressure		Pa	50 (Initial static pressure with air filter:5Pa)		
Outside air intake			Not possible		
Air filter, Quality / Quantity			Polypropylene net x 1		
Shock & vibration absorber			Cushion rubber (for fan motor)		
Operation control	Remote control		Wireless remote control		
	Room temperature control		Microcomputer thermostat		
	Operation display		RUN: Green, TIMER: Yellow, HI POWER: Green, ECONO: Green		
Safety equipments			Drain error protection, Frost protection, Serial signal error protection, Indoor fan motor error protection		
Installation data	Refrigerant piping size (O.D)	mm	Liquid line: ϕ 6.35 (1/4") Gas line: ϕ 12.7 (1/2")		
	Connecting method		Flare connection		
	Insulation for piping		Necessary (Both sides), independent		
	Drain hose		Hose connectable (VP25)		
Drain pump, max lift height		mm	Built-in, MAX600		
Interconnecting wires	Size x Core number		1.5mm² x 4 cores (Including earth cable) / Terminal block (Screw fixing type)		
IP number			IPX0		
Standard accessories			Mounting kit, Joint for drain piping		
Option parts			Wired remote control, Interface kit (SC-BIKN2-E), Bottom air inlet kit		

Notes (1) The data are measured at the following conditions.

The pipe length is 5m.

Operation	Item	Indoor air temperature		Outdoor air temperature		Standards	Note
		DB	WB	DB	WB		
Cooling		27°C	19°C	35°C	24°C	ISO15042-T1	Non-duct (with air filter)
Heating		20°C	-	7°C	6°C	ISO15042-H1	

(2) This air-conditioner is manufactured and tested in conformity with the ISO.

(3) Sound level indicates the value in an anechoic chamber.

During operation these values are somewhat higher due to ambient conditions.

(4) Mike positions of measuring sound pressure level of indoor unit is shown below.

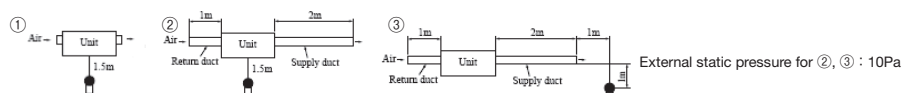

(4) 4-way ceiling cassette type (FDTC)

(a) Models FDTC25, 35, 50, 60VH

Adapted to **RoHS** directive

Item		Model		FDTC25VH		
				Panel standard : TC-PSA-5AW-E, Draft prevention : TC-PSAE-5AW-E		
Power source				1 Phase, 220-240V, 50Hz / 220V, 60Hz		
Operation data	Nominal cooling capacity (range)	kW	2.5			
	Nominal heating capacity (range)	kW	3.4			
	Sound power level	Cooling	dB(A)	51		
		Heating		53		
	Sound pressure level	Cooling		P-Hi: 38 Hi: 34 Me: 30 Lo: 27		
		Heating		P-Hi: 39 Hi: 36 Me: 32 Lo: 28		
Silent mode sound pressure level		-				
Exterior dimensions (Height x Width x Depth)		mm		Unit 248 x 570 x 570 Panel 10 x 620 x 620		
Exterior appearance (Equivalent color)			Fine snow (8.0Y 9.3/0.1) , RAL : 9003			
Net weight		kg	Unit : 14, Panel : 2.5			
Heat exchanger			Louver fins & inner grooved tubing			
Fan type & Q'ty			Turbo fan x 1			
Fan motor (Starting method)		W	50 (Direct drive)			
Air flow	Cooling	m ³ /min	P-Hi: 8.5 Hi: 7.5 Me: 7.0 Lo: 6.0			
	Heating		P-Hi: 9.5 Hi: 8.5 Me: 7.5 Lo: 6.5			
Available external static pressure		Pa	0			
Outside air intake			Possible			
Air filter, Quality / Quantity			Pocket plastic net (washable) x 1			
Shock & vibration absorber			Rubber sleeve (for fan motor)			
Operation control	Remote control		Wired : RC - EX3A, RC - E5, RCH - E3 (option), Wireless : RCN-TC-5AW-E3 (option)			
	Room temperature control		Thermostat by electronics			
	Operation display		-			
Safety equipments			Overload protection for fan motor, Frost protection thermostat			
Installation data	Refrigerant piping size (O.D)	mm	Liquid line: φ 6.35 (1/4") Gas line: φ 9.52 (3/8")			
	Connecting method		Flare connection			
	Attached length of piping	m	-			
	Insulation for piping		Necessary (Both sides), independent			
Drain hose			Hose connectable with VP25(O.D.32)			
Drain pump, max lift height		mm	Built-in Drain pump, 850			
Interconnecting wires	Size x Core number		1.5mm ² x 4 cores (Including earth cable) / Terminal block (Screw fixing type)			
IP number			IPX0			
Standard accessories			Mounting kit, Drain hose			
Option parts			OA spacer : TC-OAS-E2, TC-OAD-E, Motion sensor : LB-TC-5W-E			
Notes (1) The data are measured at the following conditions.				The pipe length is 5m.		
Operation	Item	Indoor air temperature		Outdoor air temperature		Standards
		DB	WB	DB	WB	
	Cooling	27°C	19°C	35°C	24°C	
Heating	20°C	-	7°C	6°C	ISO15042-H1	
(2) This air-conditioner is manufactured and tested in conformity with the ISO.						
(3) Sound level indicates the value in an anechoic chamber.						
During operation these values are somewhat higher due to ambient conditions.						

Adapted to RoHS directive

Item		Model		FDTC35VH		
		Panel standard : TC-PSA-5AW-E, Draft prevention : TC-PSAE-5AW-E				
Power source		1 Phase, 220-240V, 50Hz / 220V, 60Hz				
Operation data	Nominal cooling capacity (range)	kW	3.5			
	Nominal heating capacity (range)	kW	4.5			
	Sound power level	Cooling	dB(A)	52		
		Heating		54		
	Sound pressure level	Cooling		P-Hi: 39 Hi: 36 Me: 32 Lo: 29		
		Heating		P-Hi: 41 Hi: 38 Me: 34 Lo: 30		
Silent mode sound pressure level		-				
Exterior dimensions (Height x Width x Depth)		mm		Unit 248 x 570 x 570 Panel 10 x 620 x 620		
Exterior appearance (Equivalent color)			Fine snow (8.0Y 9.3/0.1) , RAL : 9003			
Net weight		kg	Unit : 14, Panel : 2.5			
Heat exchanger			Louver fins & inner grooved tubing			
Fan type & Q'ty			Turbo fan x 1			
Fan motor (Starting method)		W	50 (Direct drive)			
Air flow	Cooling	m ³ /min	P-Hi: 9.0 Hi: 8.0 Me: 7.5 Lo: 6.5			
	Heating		P-Hi: 10.0 Hi: 9.0 Me: 8.0 Lo: 7.0			
Available external static pressure		Pa	0			
Outside air intake			possible			
Air filter, Quality / Quantity			Pocket plastic net (washable) x 1			
Shock & vibration absorber			Rubber sleeve (for fan motor)			
Operation control	Remote control		Wired : RC - EX3A, RC - E5, RCH - E3 (option), Wireless : RCN-TC-5AW-E3 (option)			
	Room temperature control		Thermostat by electronics			
	Operation display		-			
Safety equipments			Overload protection for fan motor, Frost protection thermostat			
Installation data	Refrigerant piping size (O.D)	mm	Liquid line: ϕ 6.35 (1/4") Gas line: ϕ 9.52 (3/8")			
	Connecting method		Flare connection			
	Attached length of piping	m	-			
	Insulation for piping		Necessary (Both sides), independent			
Drain hose			Hose connectable with VP25(O.D.32)			
Drain pump, max lift height		mm	Built-in Drain pump, 850			
Interconnecting wires	Size x Core number		1.5mm ² x 4 cores (Including earth cable) / Terminal block (Screw fixing type)			
IP number			IPX0			
Standard accessories			Mounting kit, Drain hose			
Option parts			OA spacer : TC-OAS-E2, TC-OAD-E, Motion sensor : LB-TC-5W-E			
Notes (1) The data are measured at the following conditions. The pipe length is 5m.						
Operation	Item	Indoor air temperature		Outdoor air temperature		Standards
		DB	WB	DB	WB	
	Cooling	27°C	19°C	35°C	24°C	
Heating	20°C	-	7°C	6°C	ISO15042-H1	
(2) This air-conditioner is manufactured and tested in conformity with the ISO.						
(3) Sound level indicates the value in an anechoic chamber.						
During operation these values are somewhat higher due to ambient conditions.						

Adapted to **RoHS** directive

Item		Model		FDTC50VH		
				Panel standard : TC-PSA-5AW-E, Draft prevention : TC-PSAE-5AW-E		
Power source				1 Phase, 220-240V, 50Hz / 220V, 60Hz		
Operation data	Nominal cooling capacity (range)	kW	5.0			
	Nominal heating capacity (range)	kW	5.8			
	Sound power level	Cooling	dB(A)	59		
		Heating		59		
	Sound pressure level	Cooling		P-Hi: 44 Hi: 40 Me: 35 Lo: 27		
		Heating		P-Hi: 44 Hi: 40 Me: 35 Lo: 27		
Silent mode sound pressure level		-				
Exterior dimensions (Height x Width x Depth)		mm		Unit 248 x 570 x 570 Panel 10 x 620 x 620		
Exterior appearance (Equivalent color)		Fine snow (8.0Y 9.3/0.1) , RAL : 9001				
Net weight		kg	Unit : 14, Panel : 2.5			
Heat exchanger		Louver fins & inner grooved tubing				
Fan type & Q'ty		Turbo fan x 1				
Fan motor (Starting method)		W	50 (Direct drive)			
Air flow	Cooling	m³/min	P-Hi: 13.0 Hi: 11.0 Me: 9.0 Lo: 7.0			
	Heating		P-Hi: 13.0 Hi: 11.0 Me: 9.0 Lo: 7.0			
Available external static pressure		Pa	0			
Outside air intake		Possible				
Air filter, Quality / Quantity		Pocket plastic net (washable) x 1				
Shock & vibration absorber		Rubber sleeve (for fan motor)				
Operation control	Remote control	Wired : RC - EX3A, RC - E5, RCH - E3 (option), Wireless : RCN-TC-5AW-E3 (option)				
	Room temperature control	Thermostat by electronics				
	Operation display	-				
Safety equipments		Overload protection for fan motor, Frost protection thermostat				
Installation data	Refrigerant piping size (O.D)	mm	Liquid line: φ 6.35 (1/4") Gas line: φ 12.7 (1/2")			
	Connecting method	Flare connection				
	Attached length of piping	m	-			
	Insulation for piping	Necessary (Both sides), independent				
Drain hose		Hose connectable with VP25(O.D.32)				
Drain pump, max lift height		mm	Built-in Drain pump, 850			
Interconnecting wires	Size x Core number	1.5mm² x 4 cores (Including earth cable) / Terminal block (Screw fixing type)				
IP number		IPX0				
Standard accessories		Mounting kit, Drain hose				
Option parts		OA spacer : TC-OAS-E2, TC-OAD-E, Motion sensor : LB-TC-5W-E				
Notes (1) The data are measured at the following conditions.		The pipe length is 5m.				
Operation	Item	Indoor air temperature		Outdoor air temperature		Standards
		DB	WB	DB	WB	
	Cooling	27°C	19°C	35°C	24°C	
Heating	20°C	-	7°C	6°C	ISO15042-H1	
(2) This air-conditioner is manufactured and tested in conformity with the ISO.						
(3) Sound level indicates the value in an anechoic chamber.						
During operation these values are somewhat higher due to ambient conditions.						

Adapted to **RoHS** directive

Item		Model		FDTC60VH		
				Panel standard : TC-PSA-5AW-E, Draft prevention : TC-PSAE-5AW-E		
Power source				1 Phase, 220-240V, 50Hz / 220V, 60Hz		
Operation data	Nominal cooling capacity (range)	kW	6.0			
	Nominal heating capacity (range)	kW	6.8			
	Sound power level	Cooling	dB(A)	60		
		Heating		60		
	Sound pressure level	Cooling		P-Hi: 46 Hi: 42 Me: 38 Lo: 31		
		Heating		P-Hi: 46 Hi: 42 Me: 38 Lo: 31		
Silent mode sound pressure level		-				
Exterior dimensions (Height x Width x Depth)		mm		Unit 248 x 570 x 570 Panel 10 x 620 x 620		
Exterior appearance (Equivalent color)		Fine snow (8.0Y 9.3/0.1) , RAL : 9001				
Net weight		kg	Unit : 14, Panel : 2.5			
Heat exchanger		Louver fins & inner grooved tubing				
Fan type & Q'ty		Turbo fan x 1				
Fan motor (Starting method)		W	50 (Direct drive)			
Air flow	Cooling	m ³ /min	P-Hi: 14.0 Hi: 12.0 Me: 10.0 Lo: 8.0			
	Heating		P-Hi: 14.0 Hi: 12.0 Me: 10.0 Lo: 8.0			
Available external static pressure		Pa	0			
Outside air intake		Possible				
Air filter, Quality / Quantity		Pocket plastic net (washable) x 1				
Shock & vibration absorber		Rubber sleeve (for fan motor)				
Operation control	Remote control	Wired : RC - EX3A, RC - E5, RCH - E3 (option), Wireless : RCN-TC-5AW-E3 (option)				
	Room temperature control	Thermostat by electronics				
	Operation display	-				
Safety equipments		Overload protection for fan motor, Frost protection thermostat				
Installation data	Refrigerant piping size (O.D)	mm	Liquid line: ϕ 6.35 (1/4") Gas line: ϕ 12.7 (1/2")			
	Connecting method	Flare connection				
	Attached length of piping	m	-			
	Insulation for piping	Necessary (Both sides), independent				
Drain hose		Hose connectable with VP25(O.D.32)				
Drain pump, max lift height		mm	Built-in Drain pump, 850			
Interconnecting wires	Size x Core number	1.5mm ² x 4 cores (Including earth cable) / Terminal block (Screw fixing type)				
IP number		IPX0				
Standard accessories		Mounting kit, Drain hose				
Option parts		OA spacer : TC-OAS-E2, TC-OAD-E, Motion sensor : LB-TC-5W-E				
Notes (1) The data are measured at the following conditions.		The pipe length is 5m.				
Operation	Item	Indoor air temperature		Outdoor air temperature		Standards
		DB	WB	DB	WB	
	Cooling	27°C	19°C	35°C	24°C	
Heating	20°C	-	7°C	6°C	ISO15042-H1	
(2) This air-conditioner is manufactured and tested in conformity with the ISO.						
(3) Sound level indicates the value in an anechoic chamber.						
During operation these values are somewhat higher due to ambient conditions.						

(b) Models FDTC25, 35VH1

Adapted to **RoHS** directive

Item		Model		FDTC25VH1		
		Panel standard : TC-PSA-5AW-E, TC-PSAG-5AW-E, Draft prevention : TC-PSAE-5AW-E, TC-PSAGE-5AW-E				
Power source		1 Phase, 220-240V, 50Hz / 220V, 60Hz				
Operation data	Nominal cooling capacity (range)	kW		2.5		
	Nominal heating capacity (range)	kW		3.4		
	Sound power level	Cooling	dB(A)		51	
		Heating			52	
	Sound pressure level	Cooling	dB(A)		P-Hi: 38 Hi: 34 Me: 30 Lo: 27	
		Heating			P-Hi: 39 Hi: 36 Me: 32 Lo: 28	
Silent mode sound pressure level		-				
Exterior dimensions (Height x Width x Depth)		mm		Unit 248 x 570 x 570 Panel 10 x 620 x 620		
Exterior appearance (Equivalent color)		Fine snow (8.0Y 9.3/0.1) , RAL : 9003				
Net weight		kg		Unit : 13.5, Panel : 2.5		
Heat exchanger		Louver fins & inner grooved tubing				
Fan type & Q'ty		Turbo fan x 1				
Fan motor (Starting method)		W		50 (Direct drive)		
Air flow	Cooling	m ³ /min		P-Hi: 8.5 Hi: 7.5 Me: 7.0 Lo: 6.0		
	Heating			P-Hi: 9.5 Hi: 8.5 Me: 7.5 Lo: 6.5		
Available external static pressure		Pa		0		
Outside air intake		Possible				
Air filter, Quality / Quantity		Pocket plastic net (washable) x 1				
Shock & vibration absorber		Rubber sleeve (for fan motor)				
Operation control	Remote control	Wired : RC - EX3A, RC - E5, RCH - E3 (Option), Wireless : RCN-TC-5AW-E3 (Option)				
	Room temperature control	Thermostat by electronics				
	Operation display	-				
Safety equipments		Overload protection for fan motor, Frost protection thermostat				
Installation data	Refrigerant piping size (O.D)	mm		Liquid line: ϕ 6.35 (1/4") Gas line: ϕ 9.52 (3/8")		
	Connecting method	Flare connection				
	Attached length of piping	m		-		
	Insulation for piping	Necessary (Both sides), independent				
	Drain hose	Hose connectable with VP25(O.D.32)				
Drain pump, max lift height		mm		Built-in Drain pump, 850		
Interconnecting wires	Size x Core number		1.5mm ² x 4 cores (Including earth cable) / Terminal block (Screw fixing type)			
IP number		IPX0				
Standard accessories		Mounting kit, Drain hose				
Option parts		OA spacer : TC-OAS-E2, TC-OAD-E, Motion sensor : LB-TC-5W-E				

Notes (1) The data are measured at the following conditions.

The pipe length is 5m.

Operation \ Item	Indoor air temperature		Outdoor air temperature		Standards
	DB	WB	DB	WB	
Cooling	27°C	19°C	35°C	24°C	ISO15042-T1
Heating	20°C	-	7°C	6°C	ISO15042-H1

(2) This air-conditioner is manufactured and tested in conformity with the ISO.

(3) Sound level indicates the value in an anechoic chamber.

During operation these values are somewhat higher due to ambient conditions.

Adapted to **RoHS** directive

Item		Model	FDTC35VH1			
Power source			Panel standard : TC-PSA-5AW-E, TC-PSAG-5AW-E, Draft prevention : TC-PSAE-5AW-E, TC-PSAGE-5AW-E			
			1 Phase, 220-240V, 50Hz / 220V, 60Hz			
Operation data	Nominal cooling capacity (range)	kW	3.5			
	Nominal heating capacity (range)	kW	4.5			
	Sound power level	Cooling	dB(A)	52		
		Heating		53		
	Sound pressure level	Cooling		P-Hi: 39 Hi: 36 Me: 32 Lo: 29		
		Heating		P-Hi: 41 Hi: 38 Me: 34 Lo: 30		
Silent mode sound pressure level		-				
Exterior dimensions (Height x Width x Depth)		mm		Unit 248 x 570 x 570 Panel 10 x 620 x 620		
Exterior appearance (Equivalent color)			Fine snow (8.0Y 9.3/0.1) , RAL : 9003			
Net weight		kg	Unit : 13.5, Panel : 2.5			
Heat exchanger			Louver fins & inner grooved tubing			
Fan type & Q'ty			Turbo fan x 1			
Fan motor (Starting method)		W	50 (Direct drive)			
Air flow	Cooling	m ³ /min	P-Hi: 9.0 Hi: 8.0 Me: 7.5 Lo: 6.5			
	Heating		P-Hi: 10.0 Hi: 9.0 Me: 8.0 Lo: 7.0			
Available external static pressure		Pa	0			
Outside air intake			possible			
Air filter, Quality / Quantity			Pocket plastic net (washable) x 1			
Shock & vibration absorber			Rubber sleeve (for fan motor)			
Operation control	Remote control		Wired : RC - EX3A, RC - E5, RCH - E3 (Option), Wireless : RCN-TC-5AW-E3 (Option)			
	Room temperature control		Thermostat by electronics			
	Operation display		-			
Safety equipments			Overload protection for fan motor, Frost protection thermostat			
Installation data	Refrigerant piping size (O.D)	mm	Liquid line: ϕ 6.35 (1/4") Gas line: ϕ 9.52 (3/8")			
	Connecting method		Flare connection			
	Attached length of piping	m	-			
	Insulation for piping		Necessary (Both sides), independent			
	Drain hose		Hose connectable with VP25(O.D.32)			
Drain pump, max lift height		mm	Built-in Drain pump, 850			
Interconnecting wires	Size x Core number		1.5mm ² x 4 cores (Including earth cable) / Terminal block (Screw fixing type)			
IP number			IPX0			
Standard accessories			Mounting kit, Drain hose			
Option parts			OA spacer : TC-OAS-E2, TC-OAD-E, Motion sensor : LB-TC-5W-E			
Notes (1) The data are measured at the following conditions.			The pipe length is 5m.			
Operation	Item	Indoor air temperature		Outdoor air temperature		Standards
		DB	WB	DB	WB	
	Cooling	27°C	19°C	35°C	24°C	
Heating	20°C	-	7°C	6°C	ISO15042-H1	
(2) This air-conditioner is manufactured and tested in conformity with the ISO.						
(3) Sound level indicates the value in an anechoic chamber.						
During operation these values are somewhat higher due to ambient conditions.						

(5) Duct connected-Low/Middle static pressure type (FDUM)

Adapted to **RoHS** directive

Item		Model	FDUM50VH	
Power source			1 Phase, 220–240V, 50Hz / 220V, 60Hz	
Operation data	Nominal cooling capacity (range)	kW	5.0	
	Nominal heating capacity (range)	kW	5.8	
	Sound power level	Cooling	dB(A)	60
		Heating		60
	Sound pressure level	Cooling		P-Hi: 37 Hi: 32 Me: 29 Lo: 26
		Heating		P-Hi: 37 Hi: 32 Me: 29 Lo: 26
Silent mode sound pressure level		–		
Exterior dimensions (Height x Width x Depth)		mm		280 x 750 x 635
Exterior appearance (Equivalent color)			–	
Net weight		kg	29	
Heat exchanger			Louver fins & inner grooved tubing	
Fan type & Q'ty			Centrifugal fan x 1	
Fan motor (Starting method)		W	100 (Direct drive)	
Air flow	Cooling	m ³ /min	P-Hi: 13.0 Hi: 10.0 Me: 9.0 Lo: 8.0	
	Heating		P-Hi: 13.0 Hi: 10.0 Me: 9.0 Lo: 8.0	
Available external static pressure		Pa	Standard: 35, Max: 100	
Outside air intake			Possible	
Air filter, Quality / Quantity			Procure locally	
Shock & vibration absorber			Rubber sleeve (for fan motor)	
Operation control	Remote control		Wired : RC - EX3A, RC - E5, RCH - E3 (option), Wireless : RCN-KIT4-E2 (option)	
	Room temperature control		Thermostat by electronics	
	Operation display		–	
Safety equipments			Overload protection for fan motor, Frost protection thermostat	
Installation data	Refrigerant piping size (O.D)	mm	Liquid line: ϕ 6.35 (1/4") Gas line: ϕ 12.7 (1/2")	
	Connecting method		Flare connection	
	Attached length of piping	m	–	
	Insulation for piping		Necessary (Both sides), independent	
Drain hose			Hose connectable with VP25(O.D.32)	
Drain pump, max lift height		mm	Built-in Drain pump, 600	
Interconnecting wires	Size x Core number		1.5mm ² x 4 cores (Including earth cable) / Terminal block (Screw fixing type)	
IP number			IPX0	
Standard accessories			Mounting kit, Drain hose	
Option parts			Filter set: UM-FL1EF, Motion sensor: LB-KIT2	

Notes (1) The data are measured at the following conditions.

The pipe length is 7.5m.

Operation \ Item	Indoor air temperature		Outdoor air temperature		External static pressure of indoor unit	Standards
	DB	WB	DB	WB		
Cooling	27°C	19°C	35°C	24°C	35Pa	ISO15042-T1
Heating	20°C	–	7°C	6°C		ISO15042-H1

(2) This packaged air-conditioner is manufactured and tested in conformity with the ISO.

(3) Sound pressure level indicates the value in an anechoic chamber. During operation these values are somewhat higher due to ambient temperature.

(4) The operation data indicate when the air-conditioner is operated at 230V 50Hz or 220V, 60HZ.

(5) Static pressure of option air filter "UM-FL1EF" is 5Pa initially.

(6) The external static pressure setting can be changed to 10-100Pa.(For RC-EX3A and RC-E5 only)

(6) Ceiling suspended type (FDE)

Adapted to **RoHS** directive

Item		Model	FDE50VH	
Power source			1 Phase, 220–240V, 50Hz / 220V, 60Hz	
Operation data	Nominal cooling capacity (range)	kW	5.0	
	Nominal heating capacity (range)	kW	5.8	
	Sound power level	Cooling	dB(A)	60
		Heating		
	Sound pressure level	Cooling	dB(A)	P-Hi: 46 Hi: 38 Me: 36 Lo: 31
Heating				
Silent mode sound pressure level			—	
Exterior dimensions (Height x Width x Depth)		mm	210 x 1070 x 690	
Exterior appearance (Munsell color)			Plaster white (6.8Y 8.9/0.2) near equivalent	
Net weight		kg	28	
Heat exchanger			Louver fins & inner grooved tubing	
Fan type & Q'ty			Centrifugal fan x 2	
Fan motor (Starting method)		W	30 (Direct line start)	
Air flow	Cooling	m ³ /min	P-Hi: 13.0 Hi: 10.0 Me: 9.0 Lo: 7.0	
	Heating			
Available external static pressure		Pa	0	
Outside air intake			Not possible	
Air filter, Quality / Quantity			Pocket plastic net (washable) x 2	
Shock & vibration absorber			Rubber sleeve (for fan motor)	
Operation control	Remote control		Wired : RC - EX3A, RC - E5, RCH - E3 (option), Wireless : RCN-E-E3 (option)	
	Room temperature control		Thermostat by electronics	
	Operation display		—	
Safety equipments			Overload protection for fan motor, Frost protection thermostat	
Installation data	Refrigerant piping size (O.D)	mm	Liquid line: ϕ 6.35 (1/4") Gas line: ϕ 12.7 (1/2")	
	Connecting method		Flare connection	
	Attached length of piping	m	—	
	Insulation for piping		Necessary (Both sides), independent	
Drain hose			Hose connectable with VP20(O.D.26)	
Drain pump, max lift height		mm	—	
Interconnecting wires	Size x Core number		1.5mm ² x 4 cores (Including earth cable) / Terminal block (Screw fixing type)	
IP number			IPX0	
Standard accessories			Mounting kit, Drain hose	
Option parts			Motion sensor : LB-E	

Notes (1) The data are measured at the following conditions.

The pipe length is 7.5m.

Operation	Item	Indoor air temperature		Outdoor air temperature		Standards
		DB	WB	DB	WB	
Cooling		27°C	19°C	35°C	24°C	ISO15042-T1
Heating		20°C	—	7°C	6°C	ISO15042-H1

(2) This air-conditioner is manufactured and tested in conformity with the ISO.

(3) Sound level indicates the value in an anechoic chamber.

During operation these values are somewhat higher due to ambient conditions.

(4) The operation data indicates when the air-conditioner is operated at 230V 50Hz or 220V 60Hz.

2.2 Exterior dimensions

(1) Wall mounted type (SRK, SKM)

(a) Models SRK20, 25, 35, 50, 60ZSX-W, -WB, -WT

Symbol	Content
A	Gas piping SRK20, 25, 35 $\phi 9.52$ (3/8") (Flare) SRK50, 60 $\phi 12.7$ (1/2") (Flare)
B	Liquid piping $\phi 6.35$ (1/4") (Flare)
C	Hole on wall for right rear piping ($\phi 65$)
D	Hole on wall for left rear piping ($\phi 65$)
E	Drain hose VP16
F	Outlet for piping

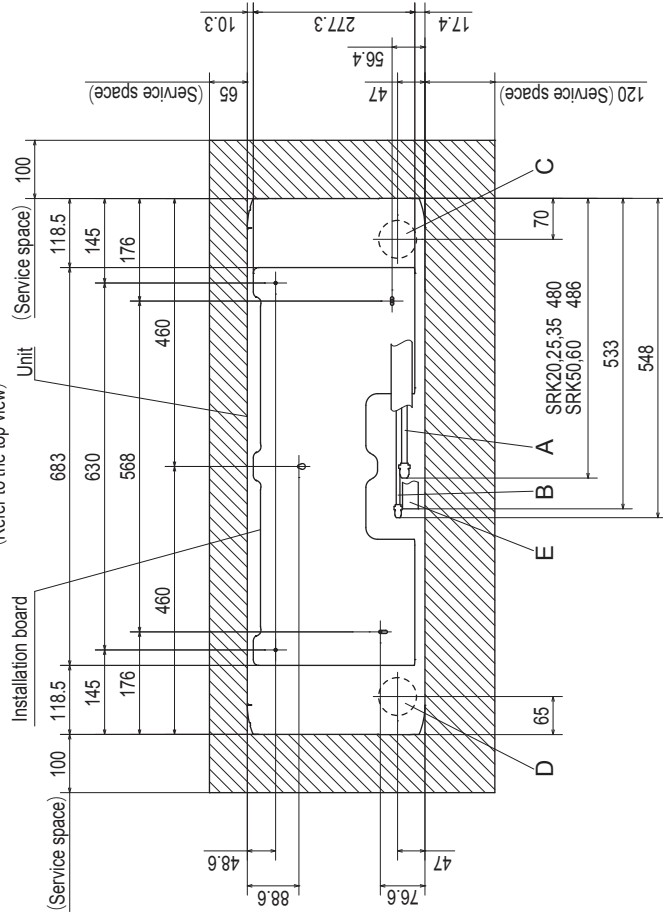
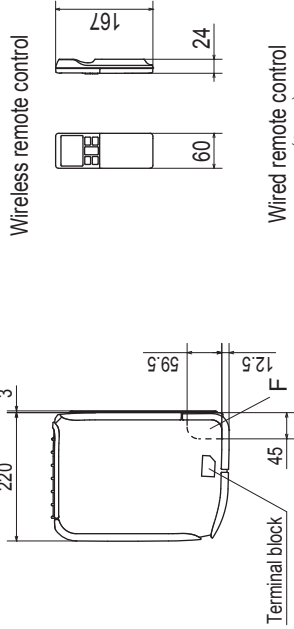
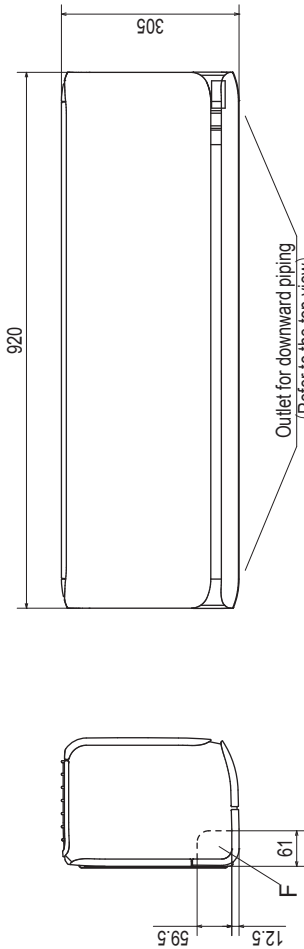
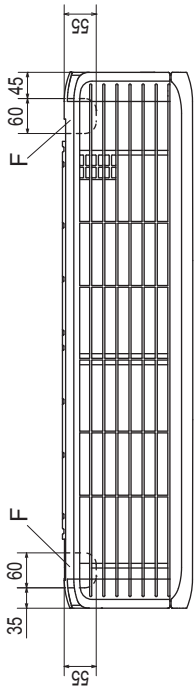

Space for installation and service when viewing from the front

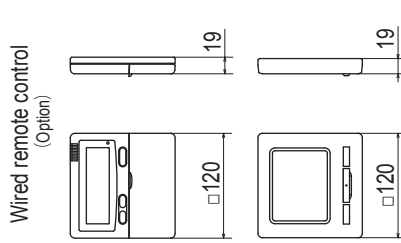
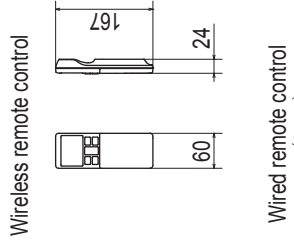

- Notes (1) The model name label is attached on the right side of the unit.
 (2) To connect the wired remote control, the interface kit (SC-BIKN2-E) is required.

Unit:mm

RLF000Z202

(b) Models SRK20, 25, 35, 50ZS-W, -WB, -WT

Symbol	Content
A	Gas piping SRK20, 25, 35 $\phi 9.52$ (3/8") (Flare) SRK50 $\phi 12.7$ (1/2") (Flare)
B	Liquid piping $\phi 6.35$ (1/4") (Flare)
C	Hole on wall for right rear piping ($\phi 65$)
D	Hole on wall for left rear piping ($\phi 65$)
E	Drain hose VP16
F	Outlet for piping (on both side)

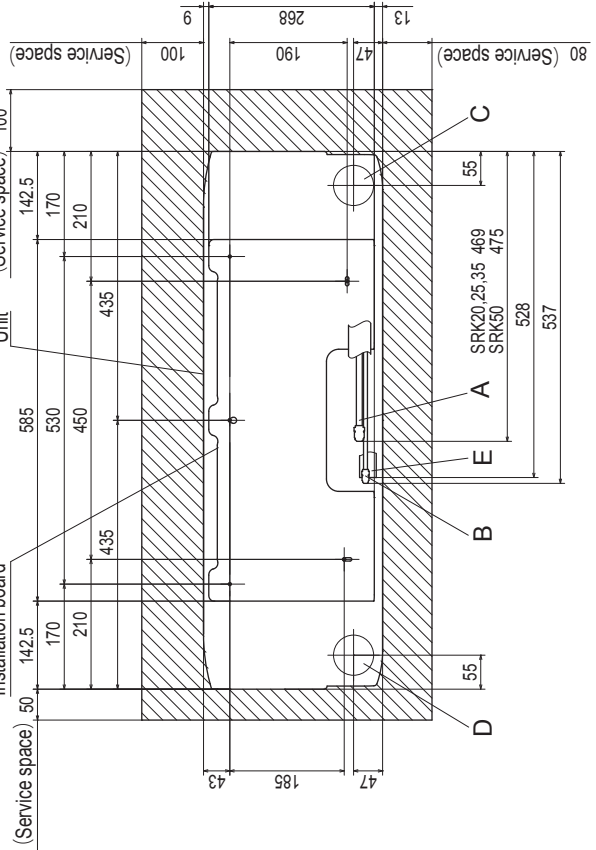
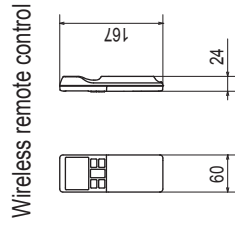
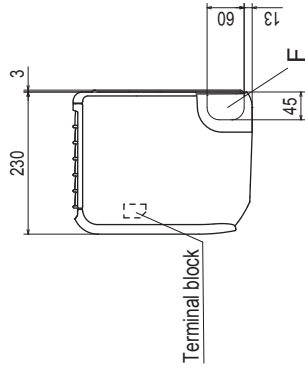
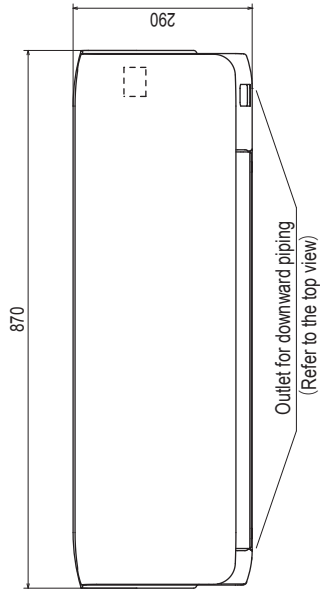
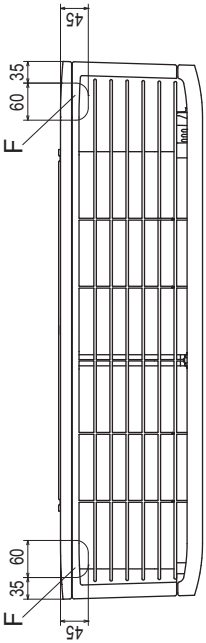

Space for installation and service when viewing from the front

- Notes
- (1) The model name label is attached on the right side of the unit.
 - (2) To connect the wired remote control, the interface kit (SC-BIKN2-E) is required.

Unit:mm

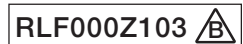

(c) Models SRK71, 80ZR-W

Symbol	Content
A	Gas piping φ15.88(5/8") (Flare)
B	Liquid piping φ6.35(1/4") (Flare)
C	Hole on wall for right rear piping (φ65)
D	Hole on wall for left rear piping (φ65)
E	Drain hose VP16
F	Outlet for wiring (on both side)
G	Outlet for piping (on both side)

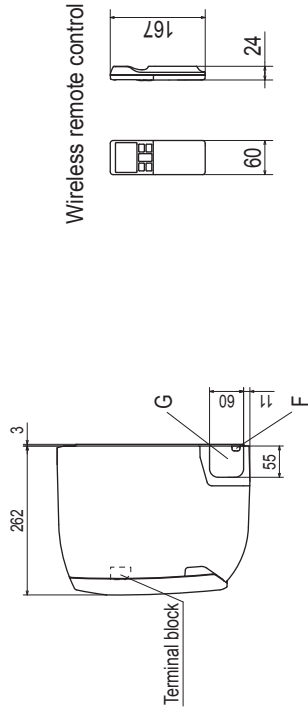
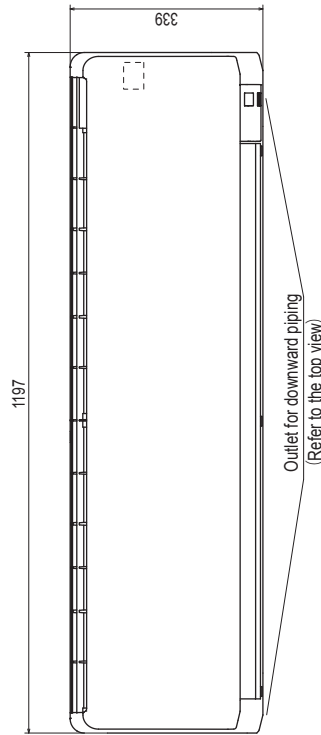
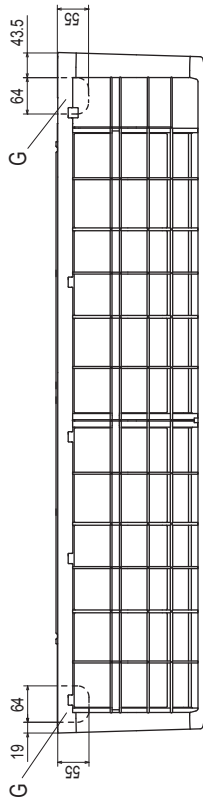

Terminal block

Wireless remote control

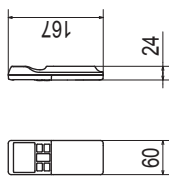

Wired remote control (Option)

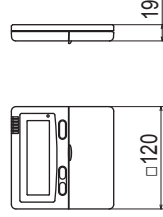

Notes (1) The model name label is attached on the underside of the indoor unit.
(2) To connect the wired remote control, the interface kit (SC-BIKN2-E) is required.

Unit:mm

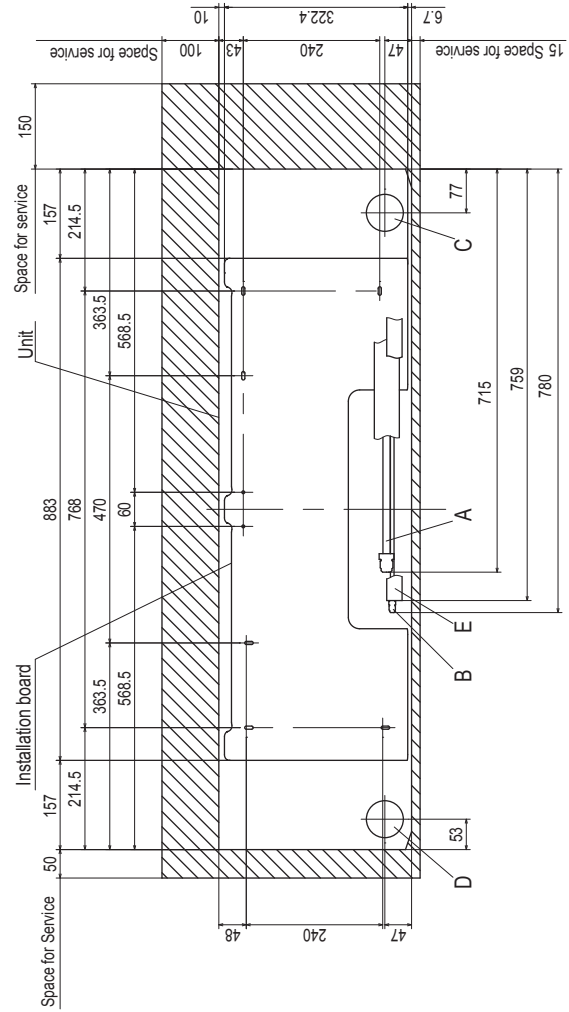

Space for installation and service when viewing from the front

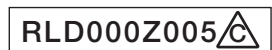

(d) Models SKM20, 25, 35ZSP-W

Symbol	Content
A	Gas piping φ9.52 (3/8") (Flare)
B	Liquid piping φ6.35 (1/4") (Flare)
C	Hole on wall for right rear piping (φ65)
D	Hole on wall for left rear piping (φ65)
E	Drain hose VP16
F	Outlet for wiring
G	Outlet for piping (on both side)

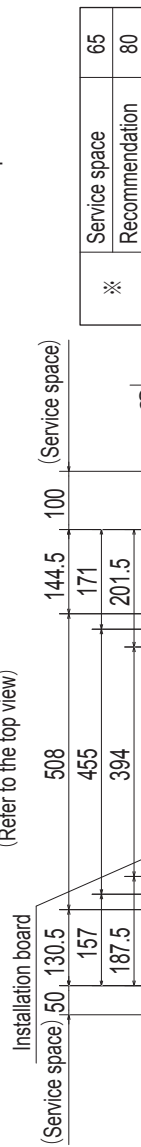
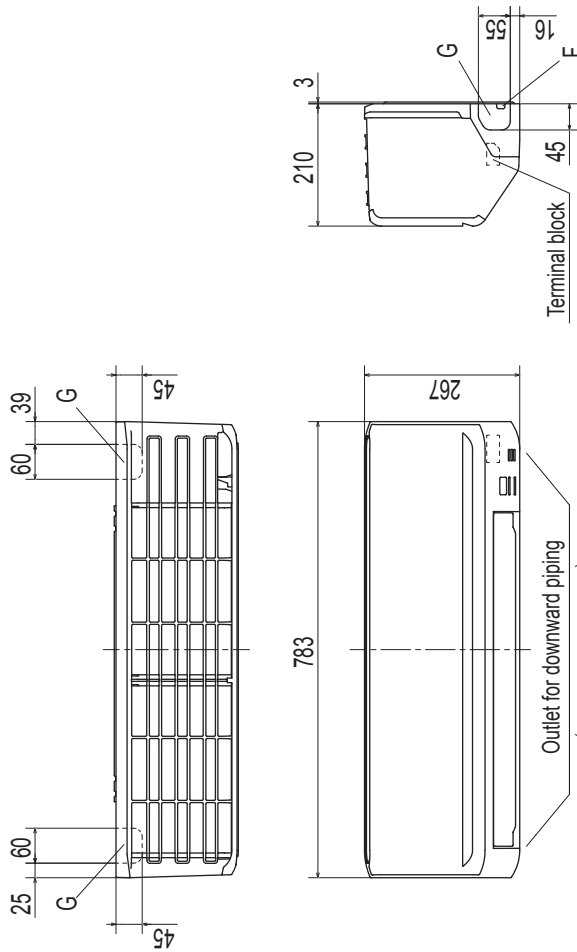

Wireless remote control

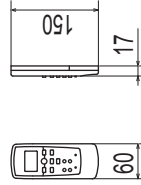

Note (1) The model name label is attached on the underside of the indoor unit.

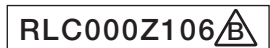

Unit:mm

Space for installation and service when viewing from the front

(2) Floor standing type (SRF)

Models SRF25, 35ZS-W, 50ZSX-W

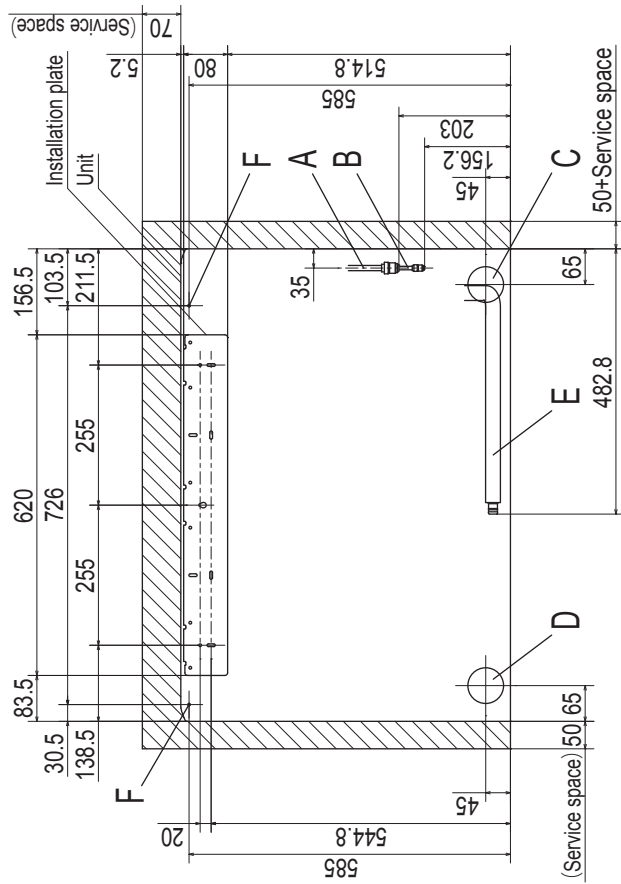

Symbol	Content
A	Gas piping Model 25.35 : φ9.52 (3/8") (Flare) 50 : φ12.7 (1/2") (Flare) φ6.35 (1/4") (Flare)
B	Liquid piping
C	Hole on wall for right rear piping (φ65)
D	Hole on wall for left rear piping (φ65)
E	Drain hose VP16
F	Screw point fasten the indoor unit φ5
G	Outlet for piping (on both side)

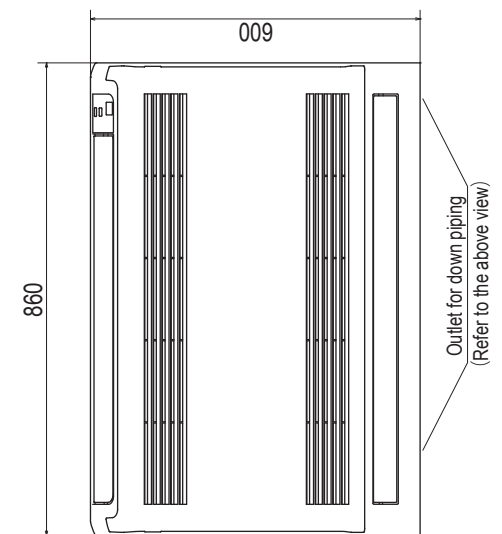
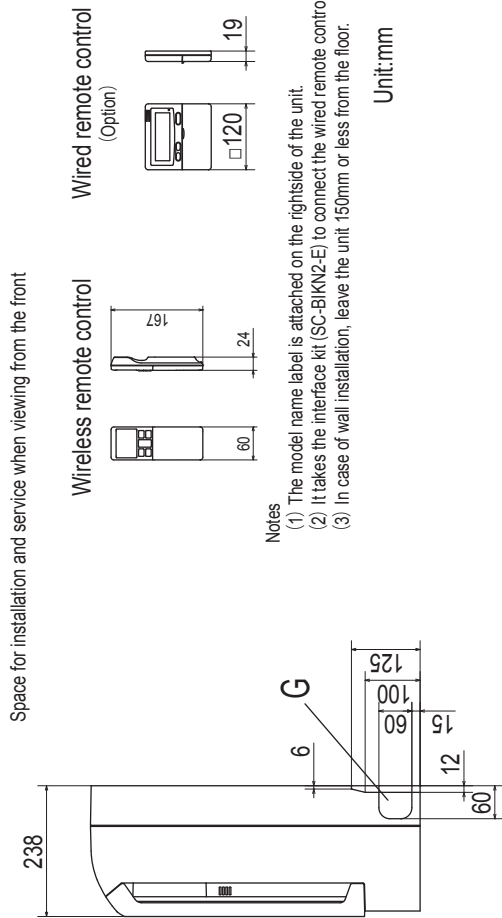
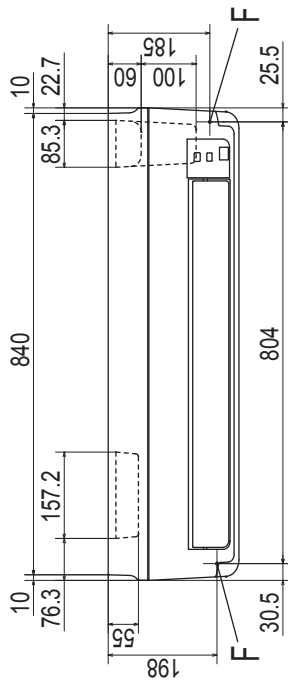

Unit:mm

(3) Ceiling concealed type (SRR)

(a) Models SRR25, 35ZM-W
SRR25, 35ZS-W

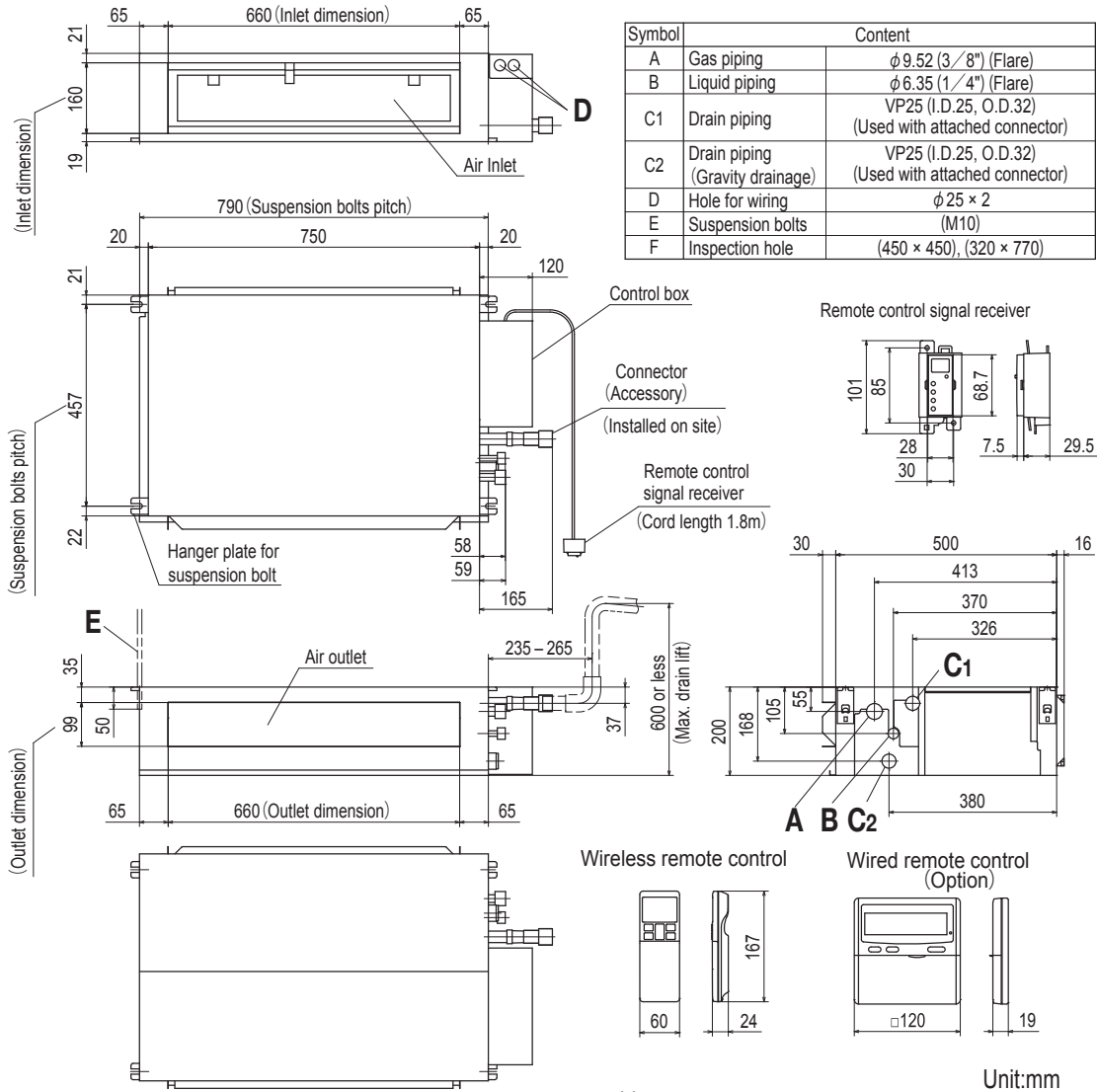

- Notes (1) The model name label is attached on the lid of the control box.
(2) It takes the interface kit (SC-BIKN2-E) to connect the wired remote control.

Space for installation and service

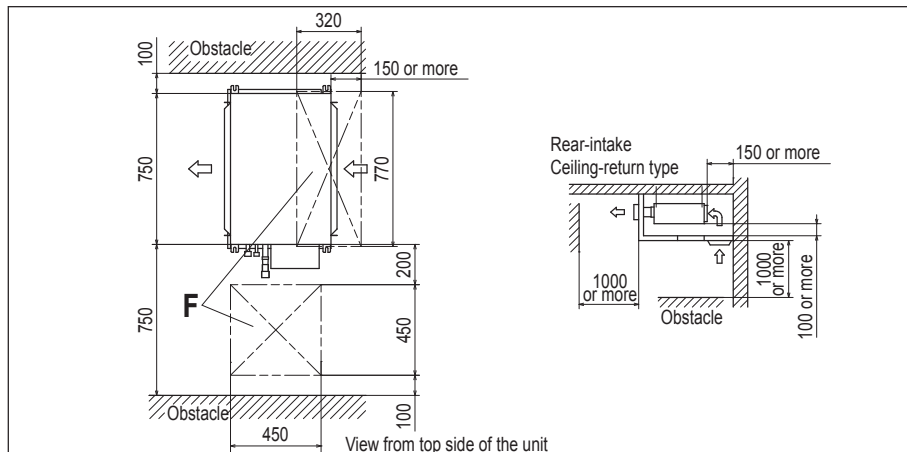

RJJ000Z001

(b) Models SRR50, 60ZS-W

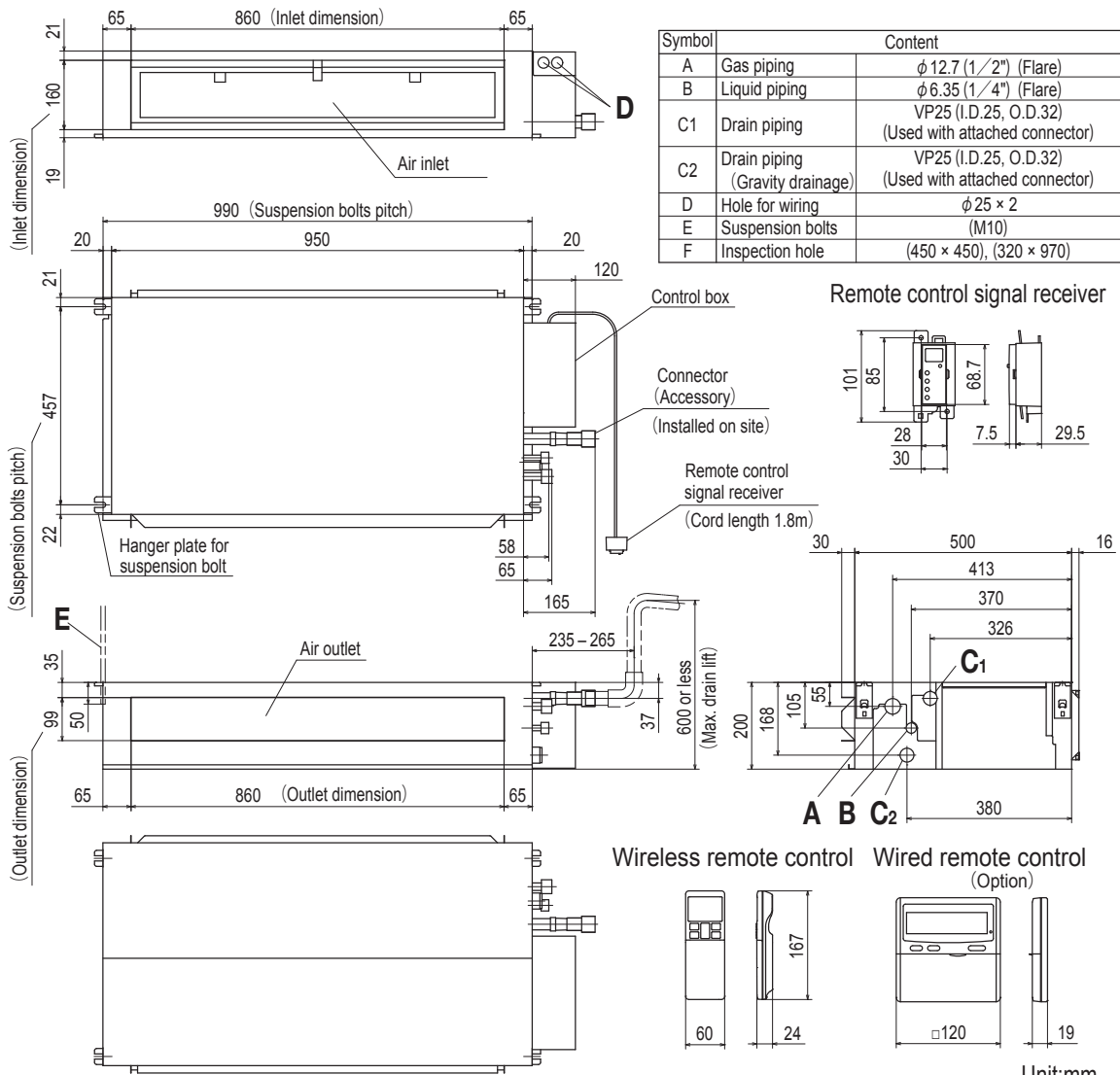

- Notes (1) The model name label is attached on the lid of the control box.
 (2) It takes the interface kit (SC-BIKN2-E) to connect the wired remote control.

Space for installation and service

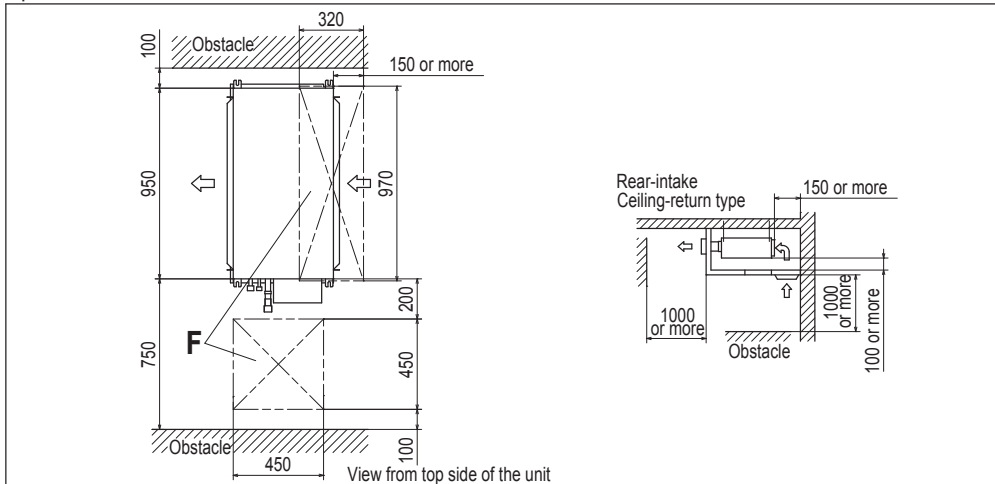

RJJ000Z002

(4) 4-way ceiling cassette type (FDTC)

Models FDTC25, 35, 50, 60VH
FDTC25, 35VH1

(a) Grid type

Symbol	Model	Content
A	Gas piping	25,35 φ9.52 (3/8") (Flare) φ12.7 (1/2") (Flare)
B	Liquid piping	φ6.35 (1/4") (Flare)
C	Drain piping	VP25 (O.D.32)
D1	Power source connection	
D2	Remote control code and signal wiring connection	
F	Suspension bolts	(M10 or M8)
G	Outside air opening for ducting	(Knock out)
H	Air outlet opening for ducting	φ125 (Knock out)
J	Inspection opening	450x450

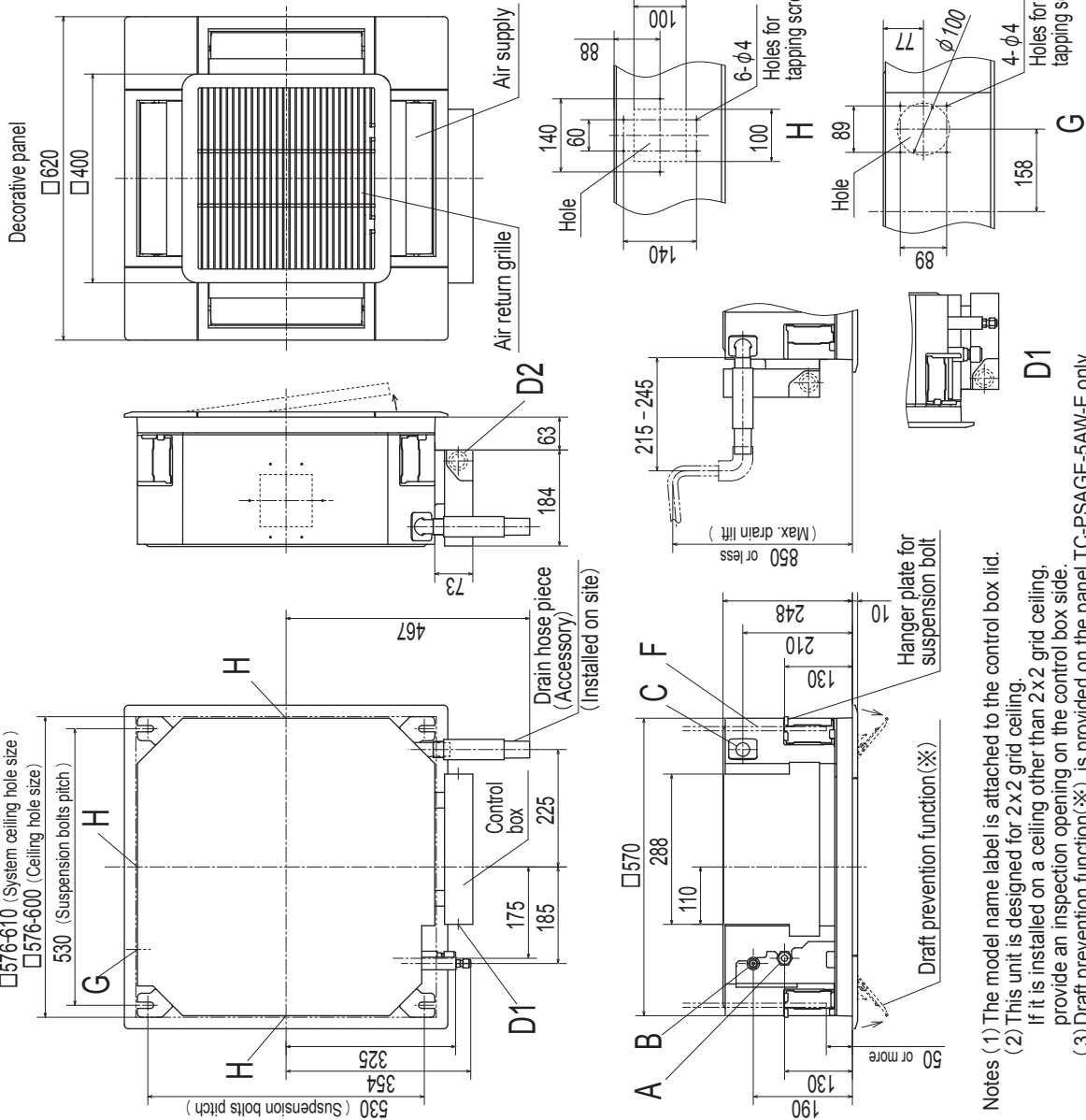

Unit: mm

Panel model name
TC-PSAG-5AW-E
TC-PSAGE-5AW-E

- Notes (1) The model name label is attached to the control box lid.
 (2) This unit is designed for 2x2 grid ceiling.
 If it is installed on a ceiling other than 2x2 grid ceiling, provide an inspection opening on the control box side.
 (3) Draft prevention function(*) is provided on the panel TC-PSAGE-5AW-E only.

(b) Honeycomb type

Symbol	Model	Content
A	Gas piping	25.35 φ9.52 (3/8") (Flare) φ12.7 (1/2") (Flare)
B	Liquid piping	φ6.35 (1/4") (Flare)
C	Drain piping	VP25 (O.D.32)
D1	Power source connection	
D2	Remote control code and signal wiring connection	
F	Suspension bolts	(M10 or M8)
G	Outside air opening for ducting	(Knock out)
H	Air outlet opening for ducting	φ125 (Knock out)
J	Inspection opening	450×450

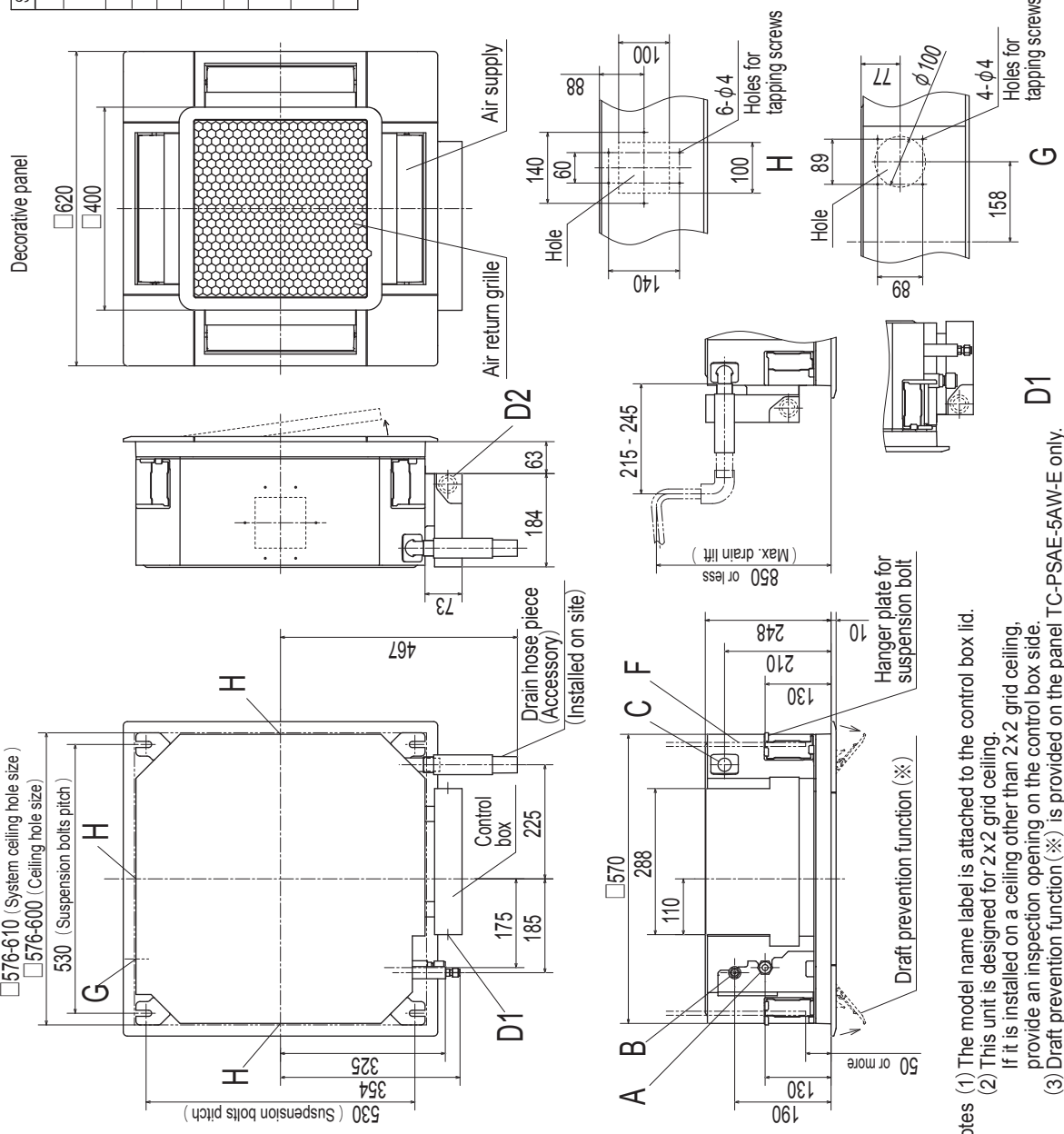

Panel model name
TC-PSA-5AW-E
TC-PSAE-5AW-E

- Notes
- (1) The model name label is attached to the control box lid.
 - (2) This unit is designed for 2x2 grid ceiling. If it is installed on a ceiling other than 2x2 grid ceiling, provide an inspection opening on the control box side.
 - (3) Draft prevention function (※) is provided on the panel TC-PSAE-5AW-E only.

(5) Duct connected-Low / Middle static pressure type (FDUM)

Model FDUM50VH

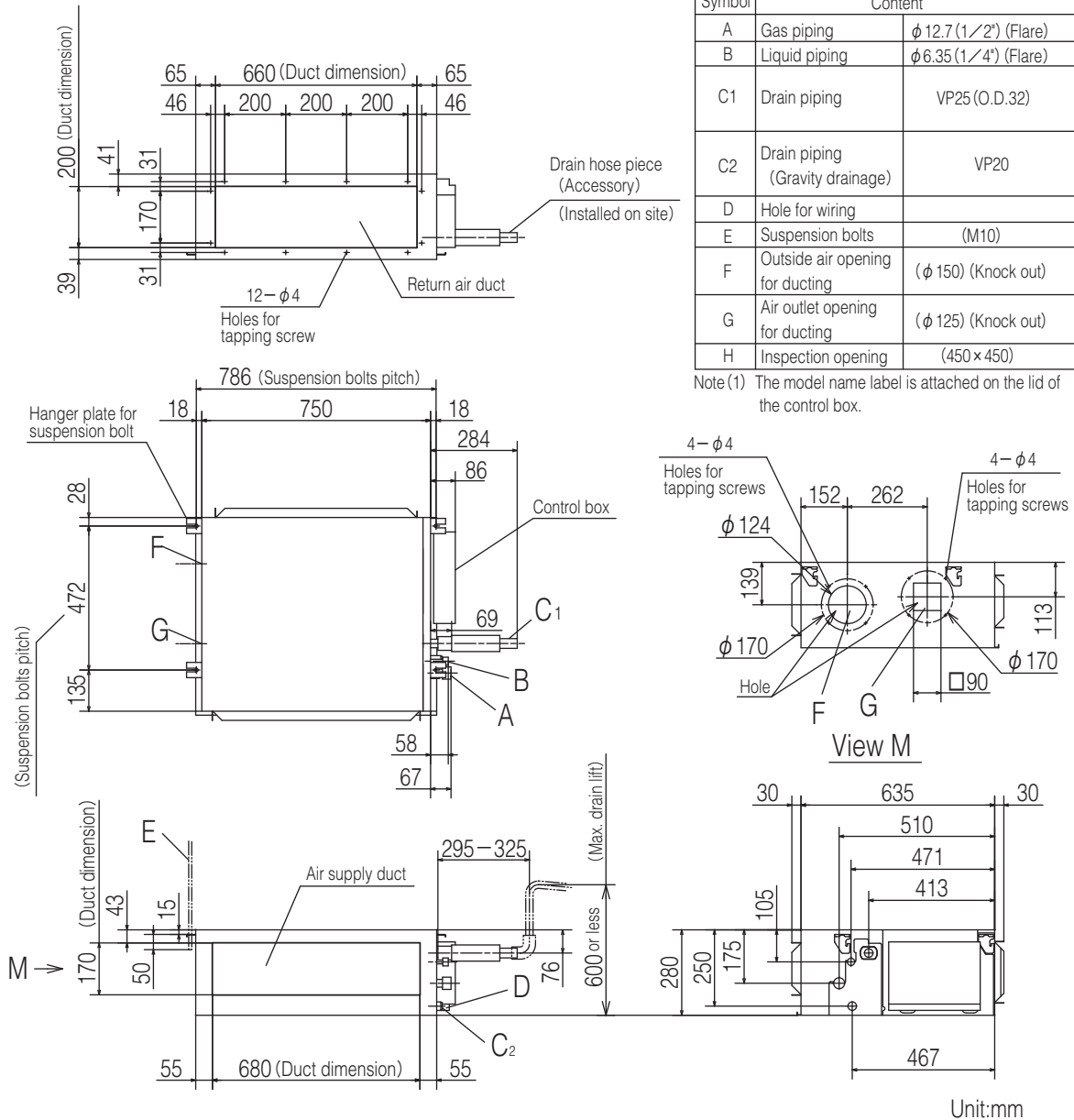

Space for installation and service

Select either of two cases to keep space for installation and services.

(Case 1) From side of unit

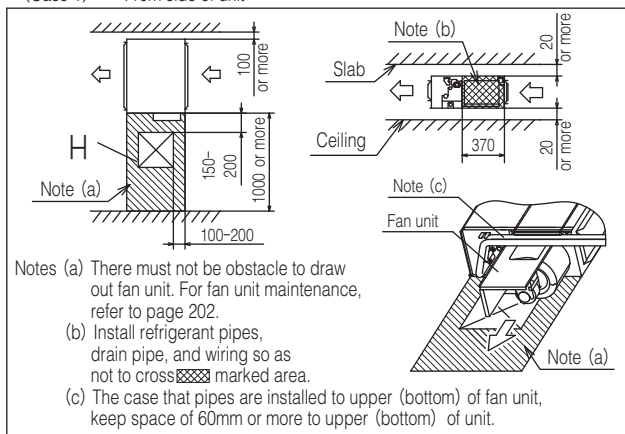

(Case 2) From bottom of unit

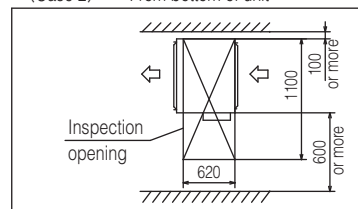

(6) Ceiling suspended type (FDE)

Model FDE50VH

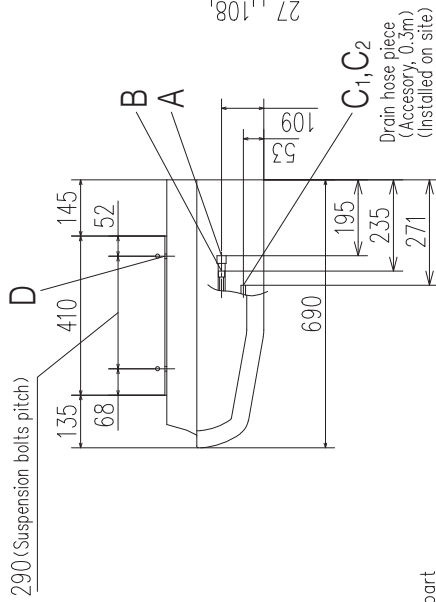
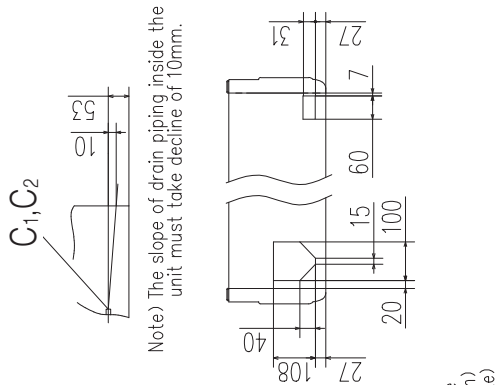

Note (1) The model name label is attached on the fan casing inside the air return grille.

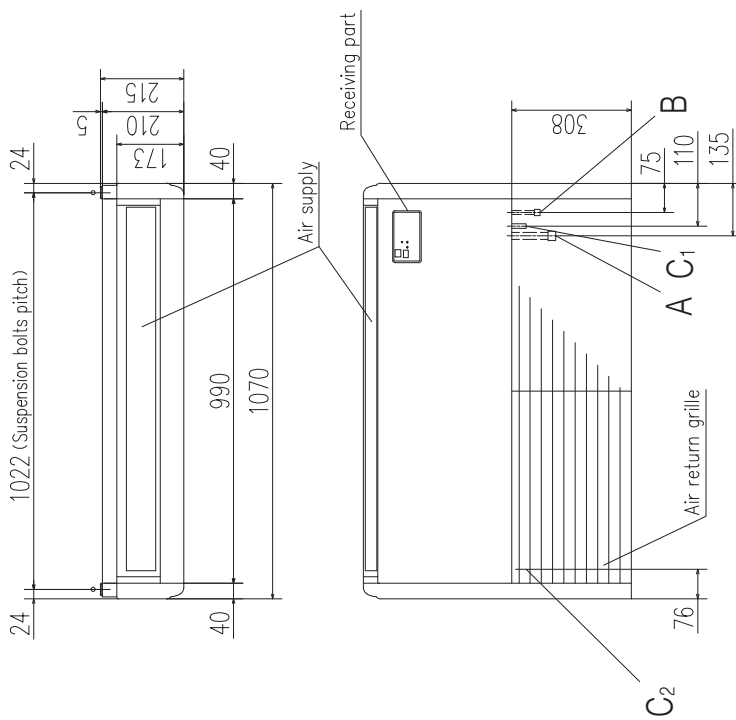

Symbol	Content
A	Gas piping φ12.7 (1/2") (Flare)
B	Liquid piping φ6.35 (1/4") (Flare)
C.1,2	Drain piping VP20
D	Hole for suspension bolts (M10 or M8)
E	Back cutout PE cover
F	Top cutout Plate cover
G	Hole for drain piping (for left back) (Knock out)

Unit: mm

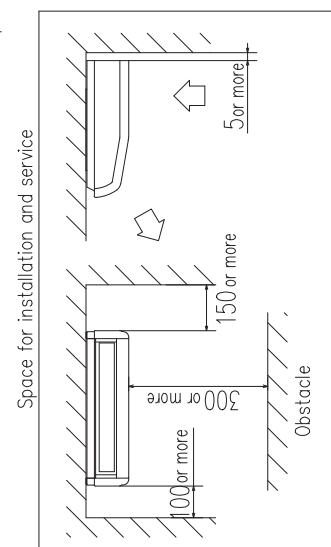
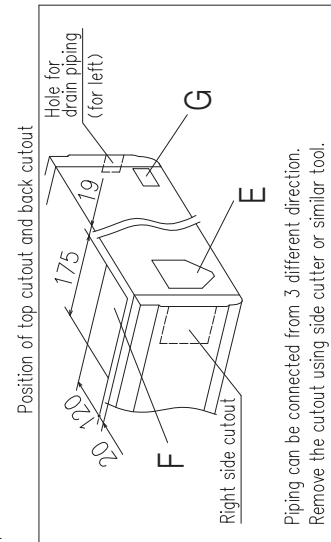

PFA004Z084

(7) Remote control

(a) Wireless remote control

Unit:mm

Models SRK, SRR, SRF (Standard parts)

Model SKM (Standard parts)

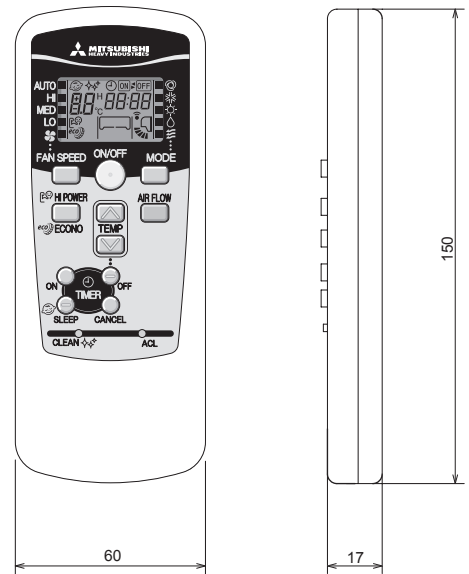
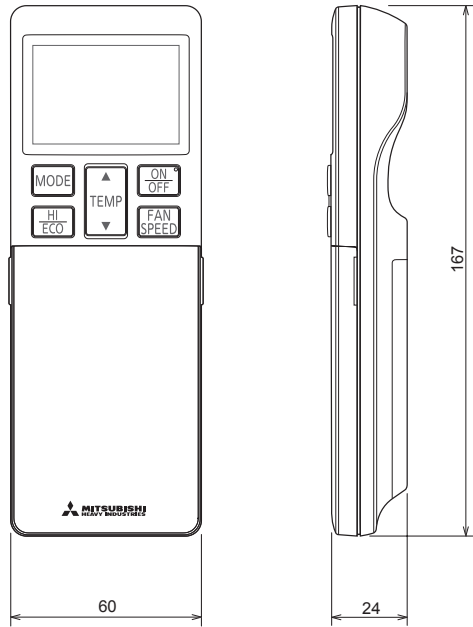

Models FDTC, FDUM, FDE (Option parts)

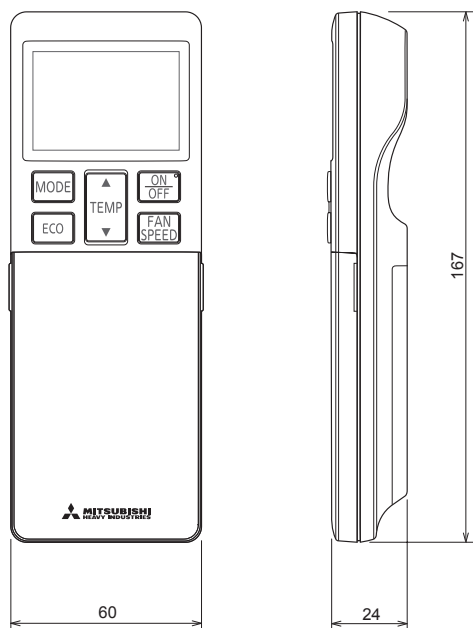

(b) Wired remote control (Option parts)

Interface kit (SC-BIKN2-E) is required to use the wired remote control. (Models SRK, SRF and SRR only)

Model RC-EX3A

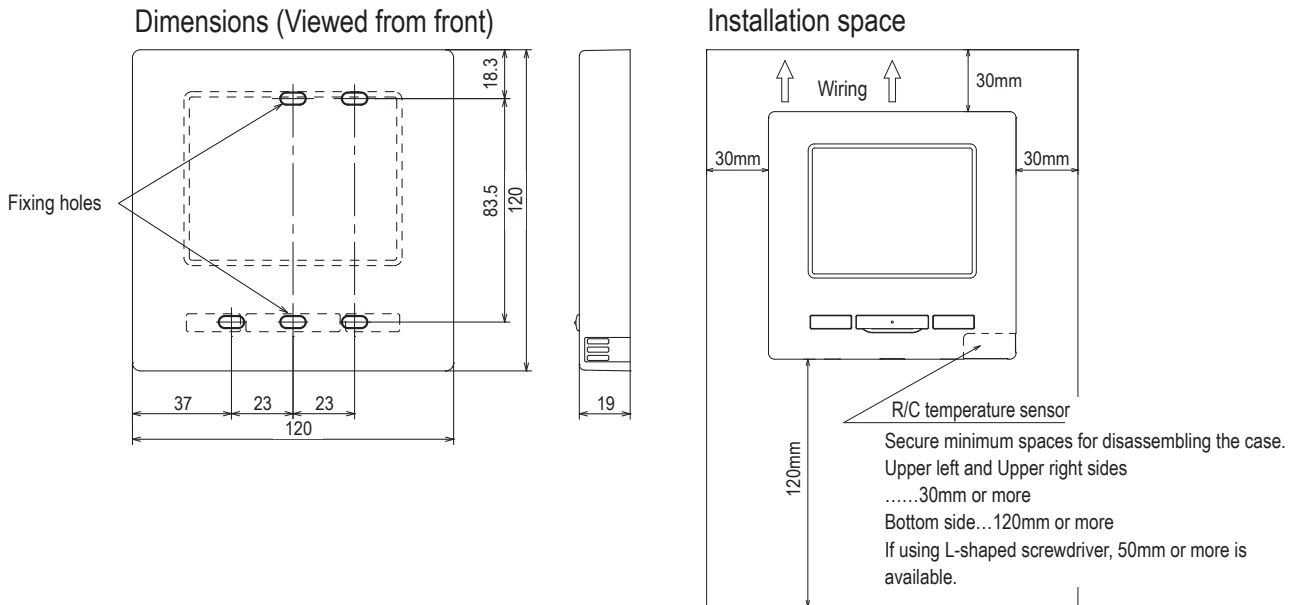

Do not install the remote control at following places.

- ① It could cause break-down or deformation of remote control.
 - Where it is exposed to direct sunlight
 - Where the ambient temperature becomes 0°C or below, or 40°C or above
 - Where the surface is not flat
 - Where the strength of installation area is insufficient
- ② Moisture may be attached to internal parts of the remote control, resulting in a display failure.
 - Place with high humidity where condensation occurs on the remote control
 - Where the remote control gets wet
- ③ Accurate room temperature may not be detected using the temperature sensor of the remote control.
 - Where the average room temperature cannot be detected
 - Place near the equipment to generate heat
 - Place affected by outside air in opening/closing the door
 - Place exposed to direct sunlight or wind from air-conditioner
 - Where the difference between wall and room temperature is large
- ④ When you are using the automatic grille up and down panel in the IU, you may not be able to confirm the up and down motion.
 - Where the IU cannot be visually confirmed

R/C cable: 0.3mm² × 2 cores

When the cable length is longer than 100m, the max size for wires used in the R/C case is 0.5mm². Connect them to wires of larger size near the outside of R/C. When wires are connected, take measures to prevent water, etc. from entering inside.

≤ 200m	0.5mm ² × 2 cores
≤ 300m	0.75mm ² × 2 cores
≤ 400m	1.25mm ² × 2 cores
≤ 600m	2.0mm ² × 2 cores

When installing the unit at a hospital, telecommunication facility, etc., take measures to suppress electric noises.

It could cause malfunction or break-down due to hazardous effects on the inverter, private power generator, high frequency medical equipment, radio communication equipment, etc.

The influences transmitted from the remote control to medical or communication equipment could disrupt medical activities, video broadcasting or cause noise interference.

Adapted RoHS directive

PJZ000Z333

Model RC-E5

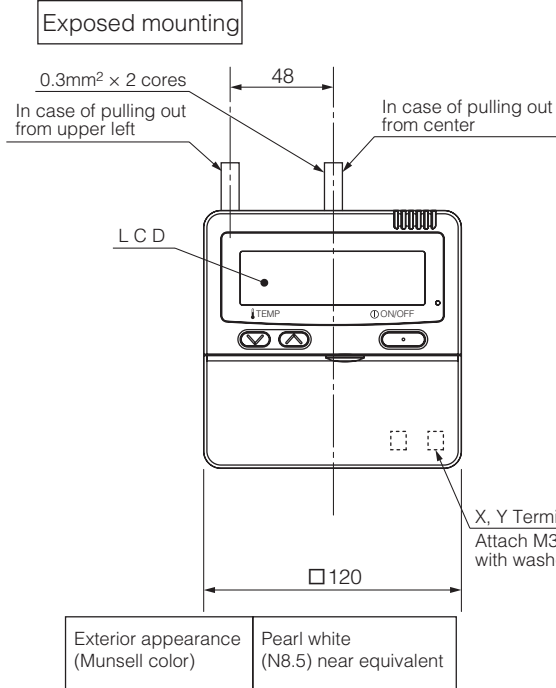

Wiring outlet
Cut off the upper thin part of remote control lower case with a nipper or knife, and grind burrs with a file etc.

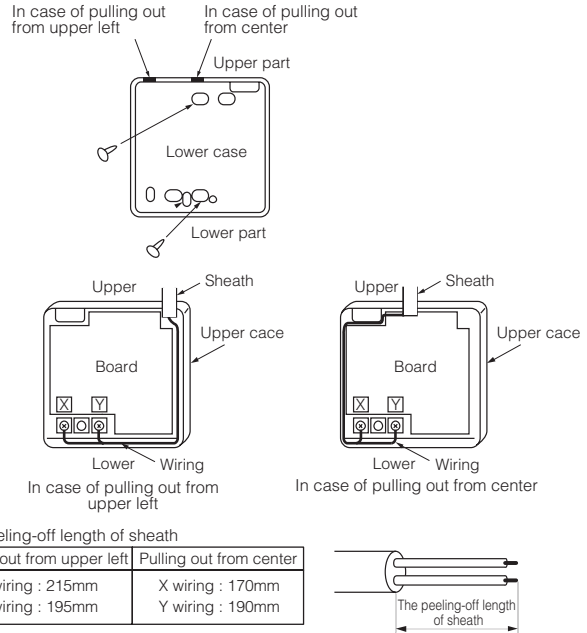

Embedded mounting

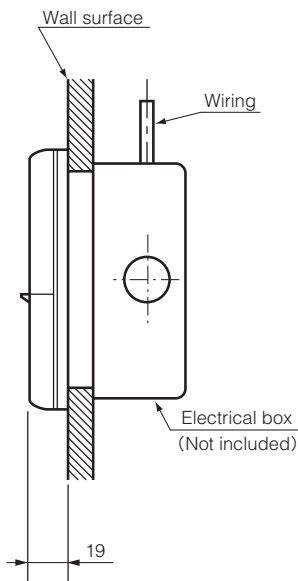

Remote control installation dimensions

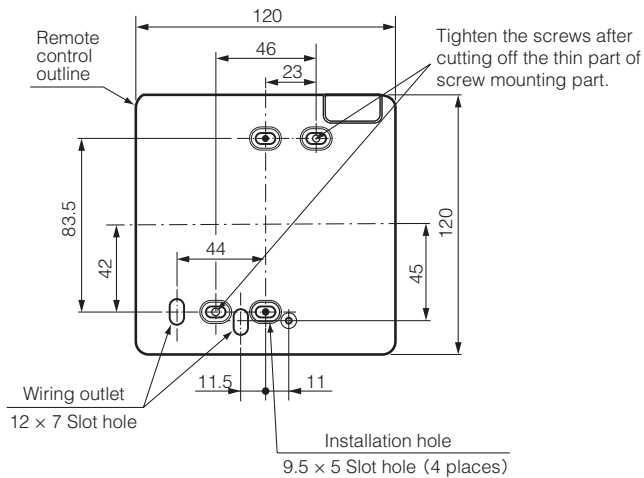

(1) Installation screw for remote control
M4 Screw (2 pieces)

Unit:mm

Wiring specifications

(1) If the prolongation is over 100m, change to the size below.
But, wiring in the remote control case should be under 0.5mm². Change the wire size outside of the case according to wire connecting. Waterproof treatment is necessary at the wire connecting section. Be careful about contact failure.

Length	Wiring thickness
100 to 200m	0.5mm ² x 2 cores
Under 300m	0.75mm ² x 2 cores
Under 400m	1.25mm ² x 2 cores
Under 600m	2.0mm ² x 2 cores

PJZ000Z295

2.3 ELECTRICAL WIRING

(1) Wall mounted type (SRK, SKM)

(a) Models SRK20, 25, 35, 50, 60ZSX-W, -WB, -WT

Item	Description
CNE	Connector
CNF	
CNG	
CNJ	
CNL	
CNM	
CNP	
CNS	
CNU	
CNX	
CNY	
CNZ	

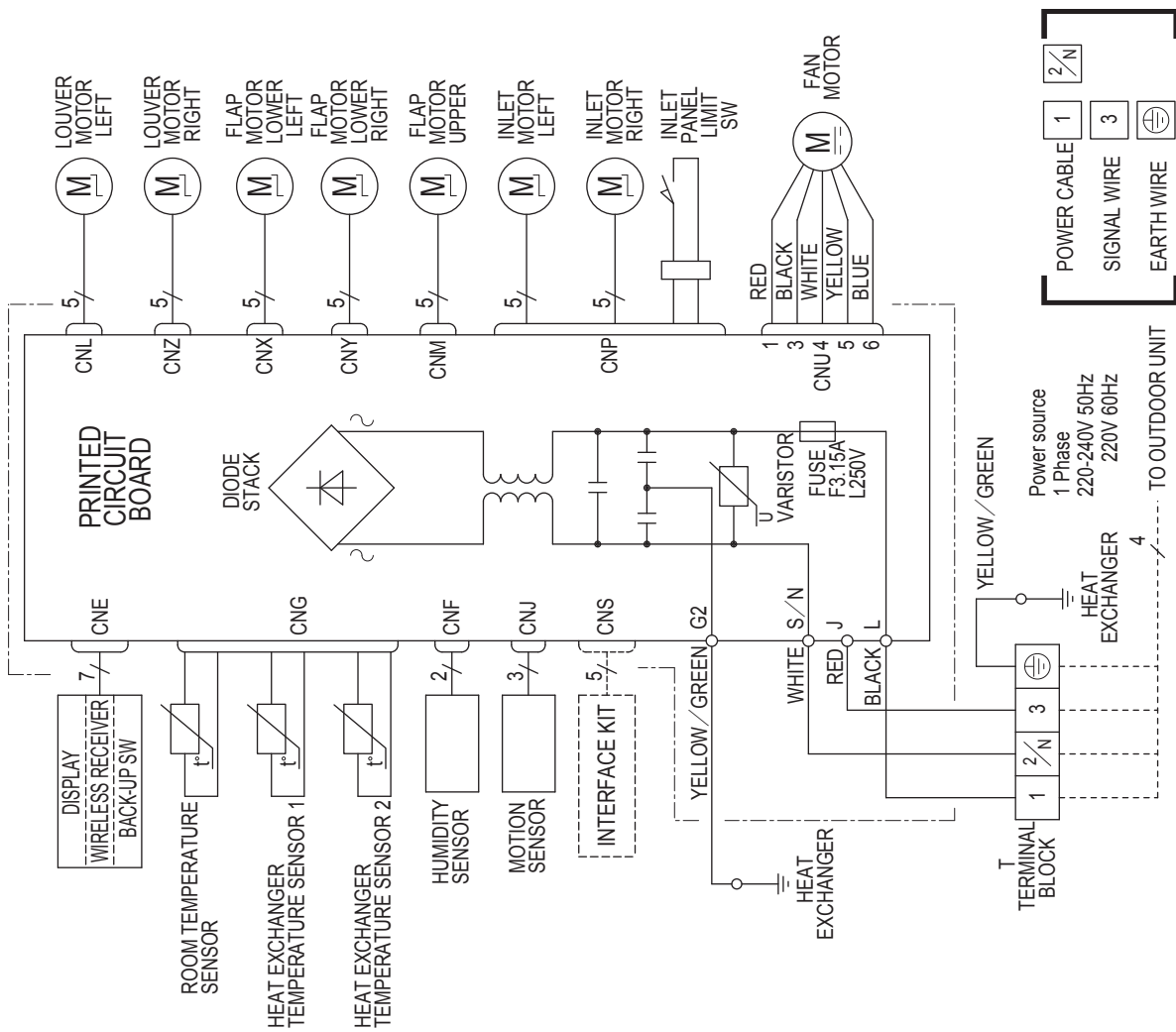

RWA000Z413

(b) Models SRK20, 25, 35, 50ZS-W, -WB, -WT

Item	Description
CNE	Connector
CNF	
CNG	
CNM	
CNS	
CNU	
CNX	
CNY	

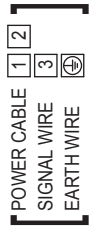
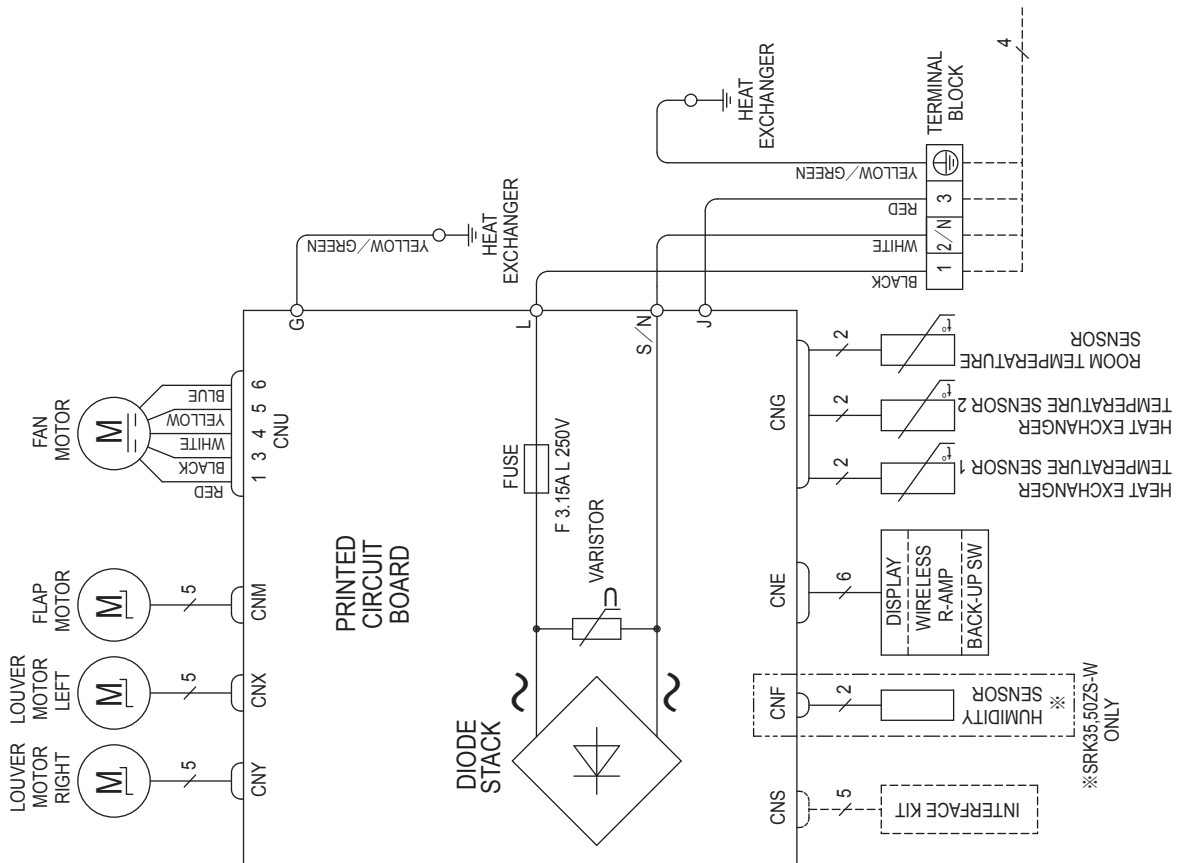

Power source
 1 Phase
 220-240V 50Hz
 220V 60Hz
 TO OUTDOOR UNIT

RWA000Z416

(c) Models SRK71, 80ZR-W

Meaning of marks

Item	Description
CNE	Connector
CNF	
CNG	
CNM	
CNS	
CNU	
CNX	
CNY	
FMi	Fan motor
SM ₁	Flap motor
LM _{1,2}	Louver motor
Th ₁	Room temperature sensor
Th _{2,1,2}	Heat exchanger temperature sensor
Th ₃	Humidity sensor
DS	Diode stack
F	Fuse
TB	Terminal block
Va	Varistor

Color marks	Mark	Color
	BK	Black
	BL	Blue
	RD	Red
	WH	White
	Y	Yellow
	Y/G	Yellow/Green

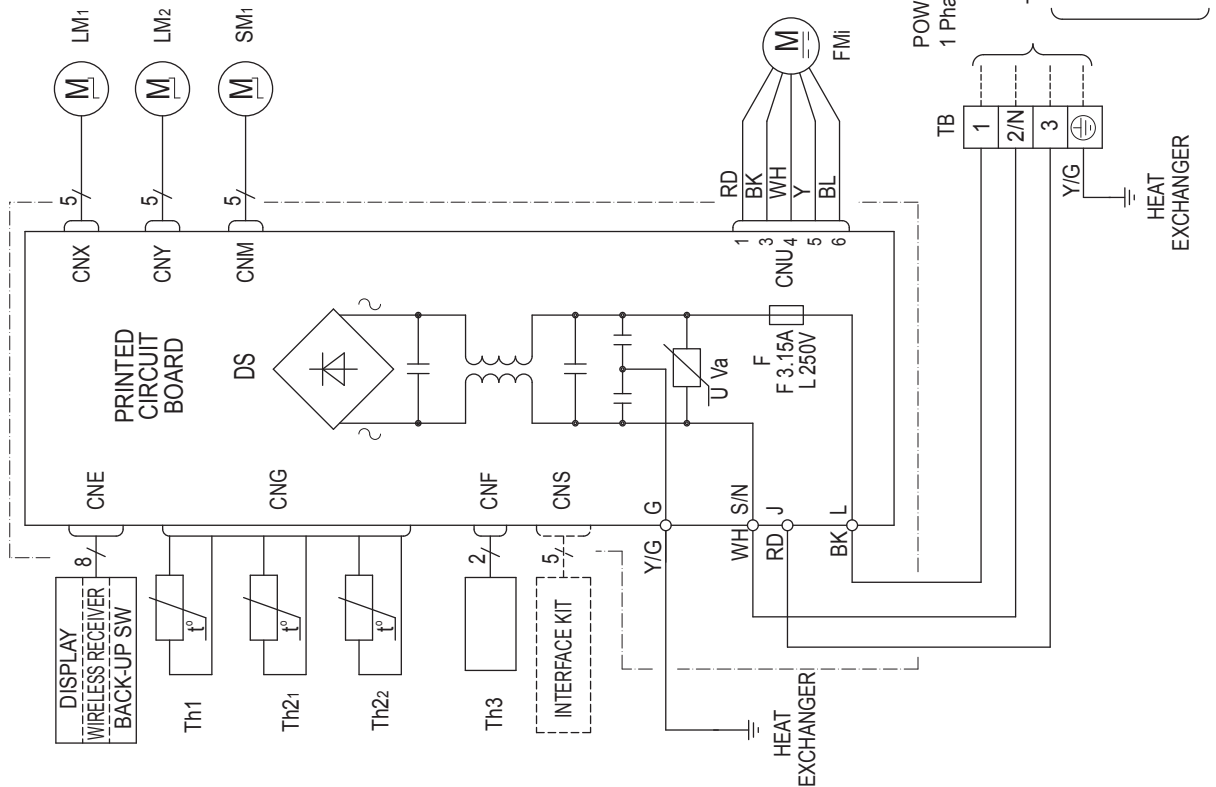

RWA000Z417

(d) Models SKM20, 25, 35ZSP-W

Item	Description
CNE	Connector
CNF	
CNG	
CNM	
CNU	

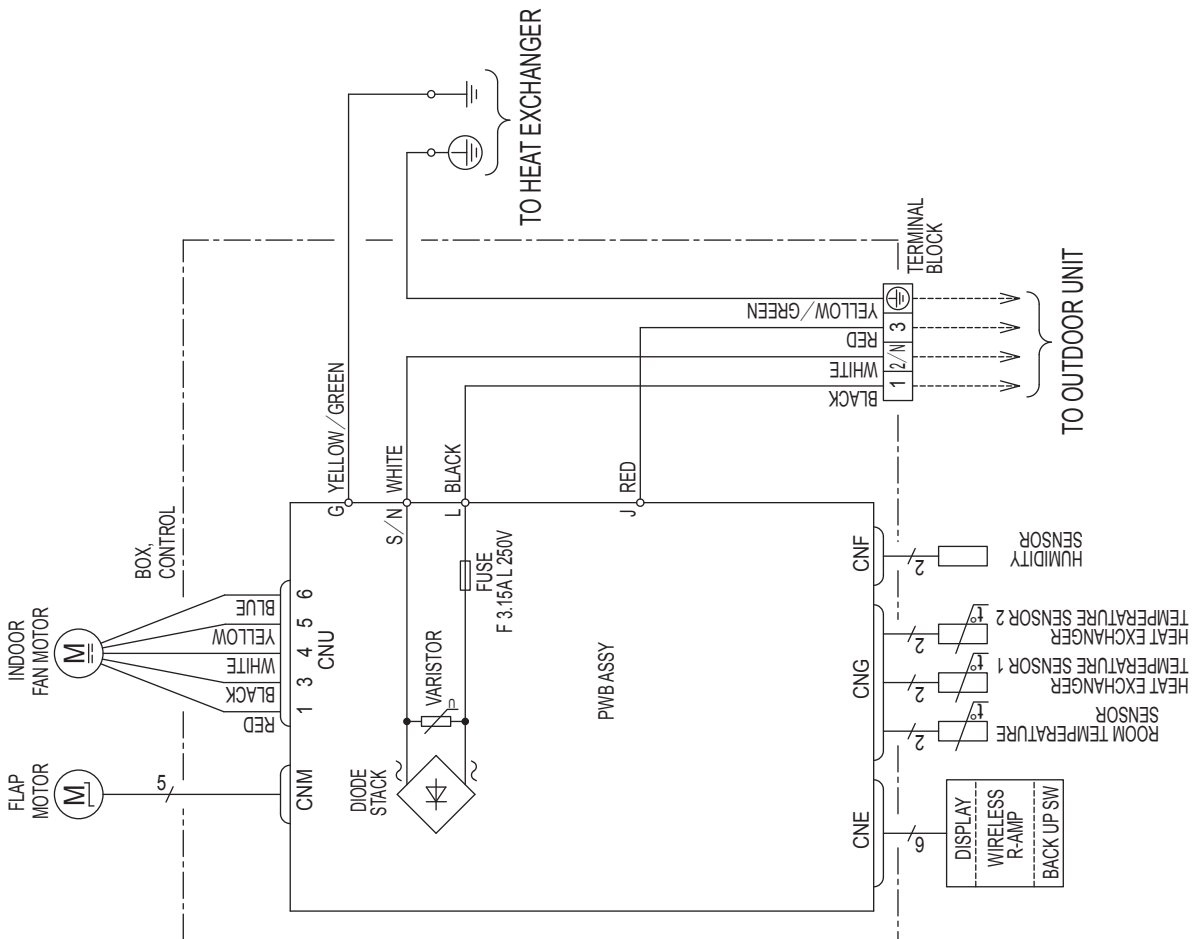

RLC000Z110

(2) Floor standing type (SRF)
 Models SRF25, 35ZS-W
 SRF50ZSX-W

Meaning of marks

Item	Description
CNE-CNX2	Connector
FMI	Fan motor
SM _{1,2}	Flap motor
DM ₁	Damper motor
DM ₂	Damper arm motor
Th1	Room temperature sensor
Th2,1,2	Heat exchanger temperature sensor
Th3	Humidity sensor
DS	Diode stack
F	Fuse
T	Terminal block
Va	Varistor

Color marks	Color
BK	Black
BL	Blue
RD	Red
WH	White
Y	Yellow
Y/G	Yellow / Green

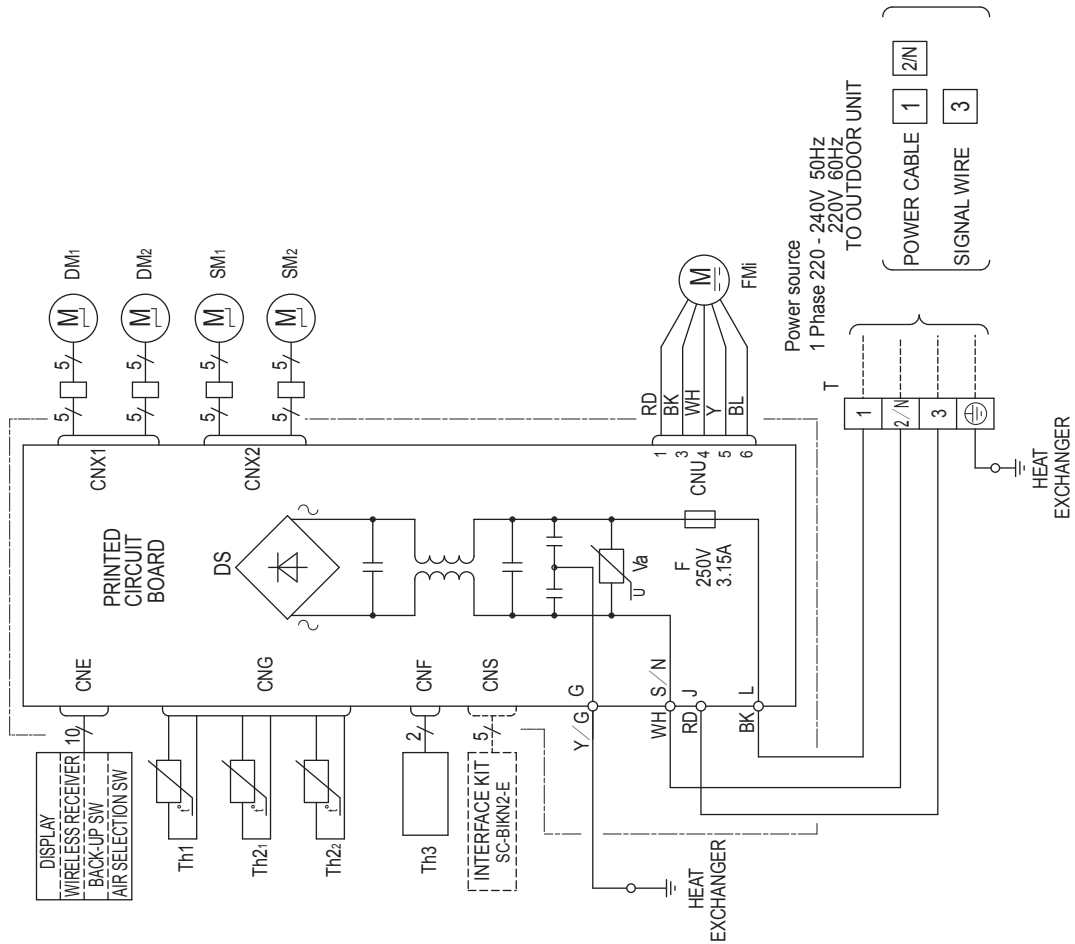

(3) Ceiling concealed type (SRR)

Models SRR25, 35ZM-W
SRR25, 35, 50, 60ZS-W

Meaning of marks

Item	Description
CNE	Connector
CNG	
CNS	
CNU	
CNW	
CNY	
FM _i	Fan motor
Th1	Room temperature sensor
Th2 _{1,2}	Heat exchanger temperature sensor
DS	Diode stack
F _{1,2}	Fuse
TB	Terminal block
DM	Drain motor
FS	Float switch
Va	Varistor

Color marks

Mark	Color
BK	Black
BL	Blue
RD	Red
WH	White
Y	Yellow
Y/G	Yellow/Green

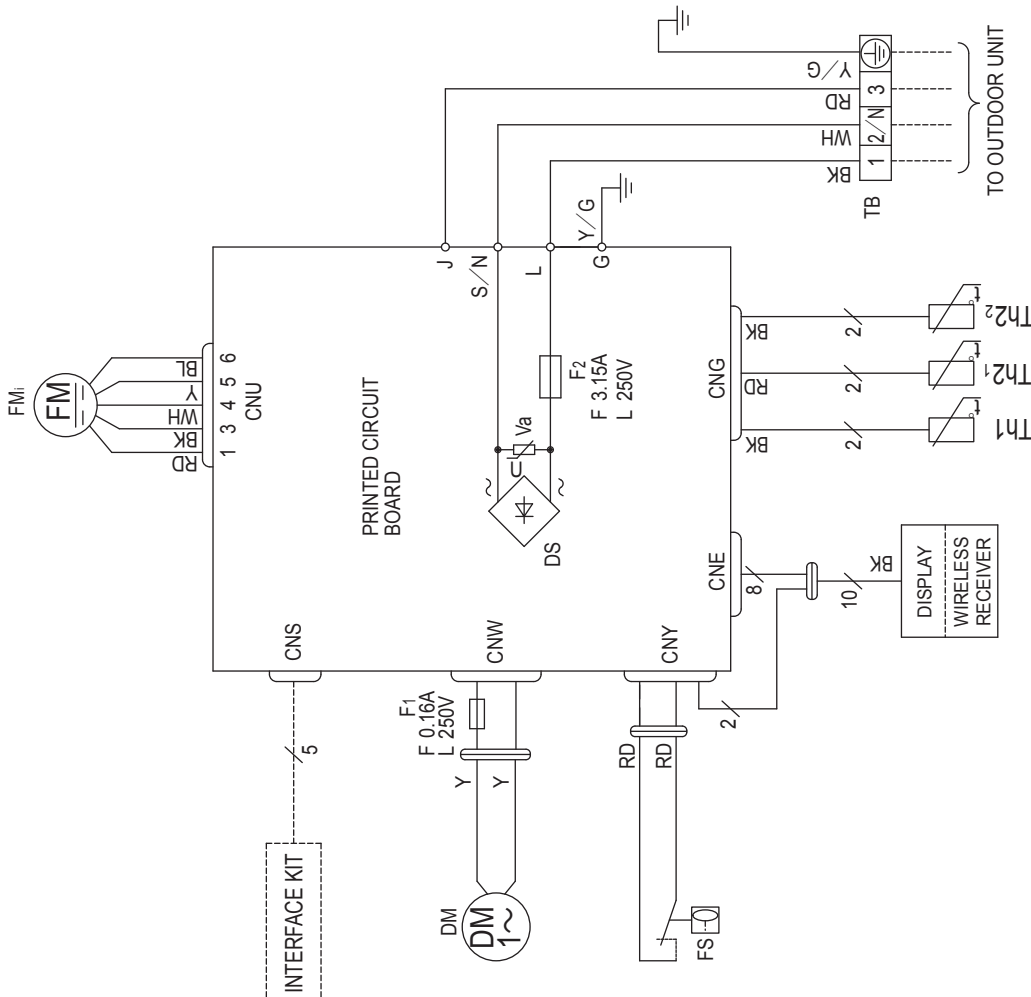

POWER SOURCE
1 PHASE 220-240V 50Hz
220V 60Hz
TO OUTDOOR UNIT



(4) 4-way ceiling cassette type (FDTC)
Models FDTC25, 35, 50, 60VH
FDTC25, 35VH1

Meaning of marks

Item	Description
AM1-4	Draft prevention function motor
CNB-Z	Connector
DM	Drain pump motor
F1,2	Fuse
FMI	Fan motor
FS	Float switch
HS	Humidity sensor
LED•2	Indication lamp (Green-Normal operation)
LED•3	Indication lamp (Red-Inspection)
LM1-4	Louver motor
PIS	Motion sensor
SW2	Remote control communication address
SW5	Plural units Master/Slave setting
SW6	Model capacity setting
SW7-1	Operation check/drain pump motor test run
TB1	Terminal block (Power source) (□ mark)
TB2	Terminal block (Signal line) (□ mark)
Thc	Temperature sensor (Remote control)
Thi-A	Temperature sensor (Return air)
Thi-R1,2,3	Temperature sensor (Heat exchanger)

Color marks

Mark	Color	Mark	Color
BK	Black	WH	White
BL	Blue	YE	Yellow
BR	Brown	GY	Gray
OR	Orange	YE/GN	Yellow/Green
RD	Red		

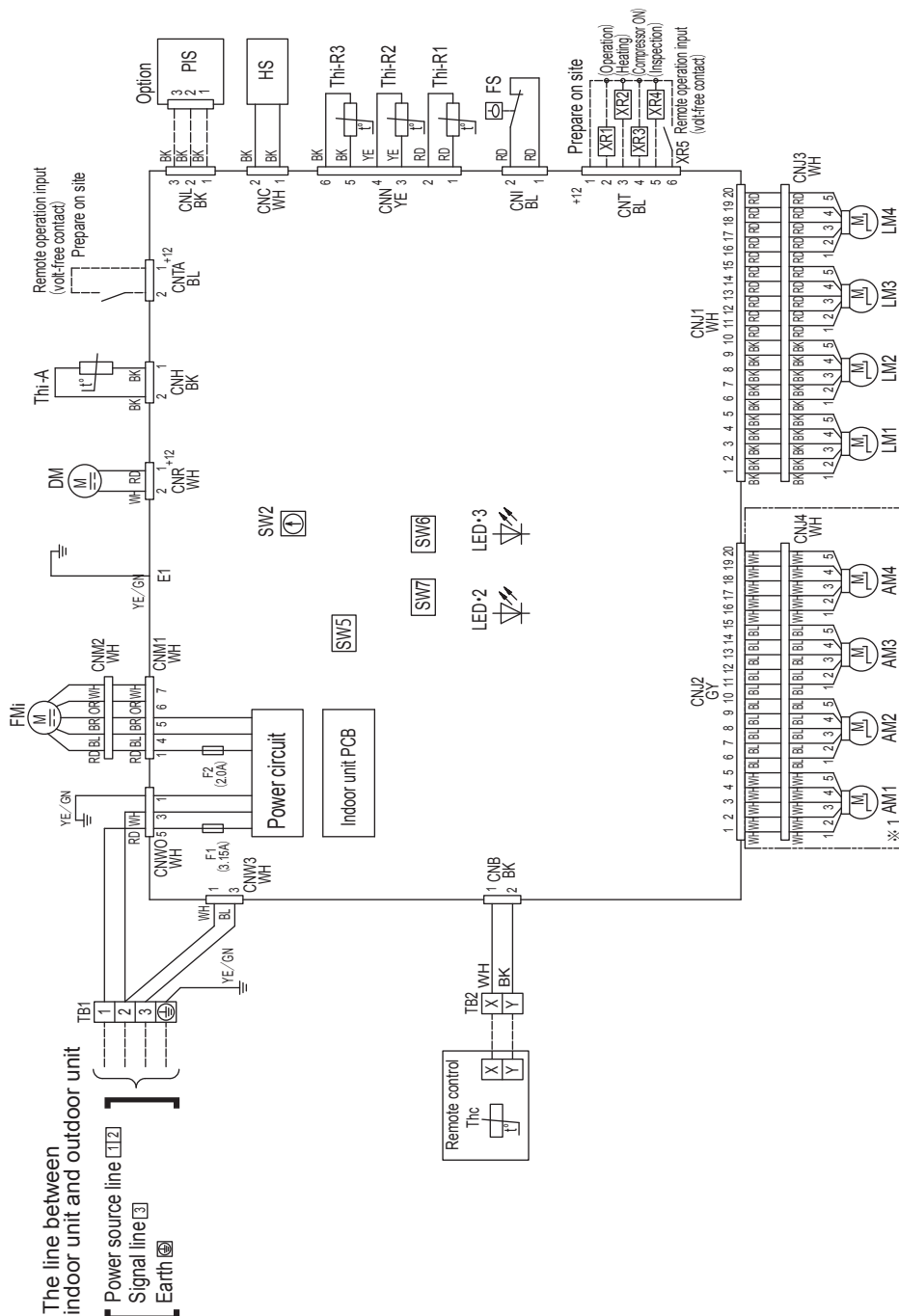

- Notes**
1. --- indicates wiring on site.
 2. See the wiring diagram of outdoor unit about the line between indoor unit and outdoor unit.
 3. Use twin core cord (0.3mm²) at remote control line.
See spec sheet of remote control in case that the total length is more than 100m.
 4. Do not put remote control line alongside power source line.
 5. Draft prevention function (※ 1) is provided on the panel TC-PSA(G)E-5AW-E only.

(5) Duct connected-Low / Middle static pressure type (FDUM)
 Model FDUM50VH

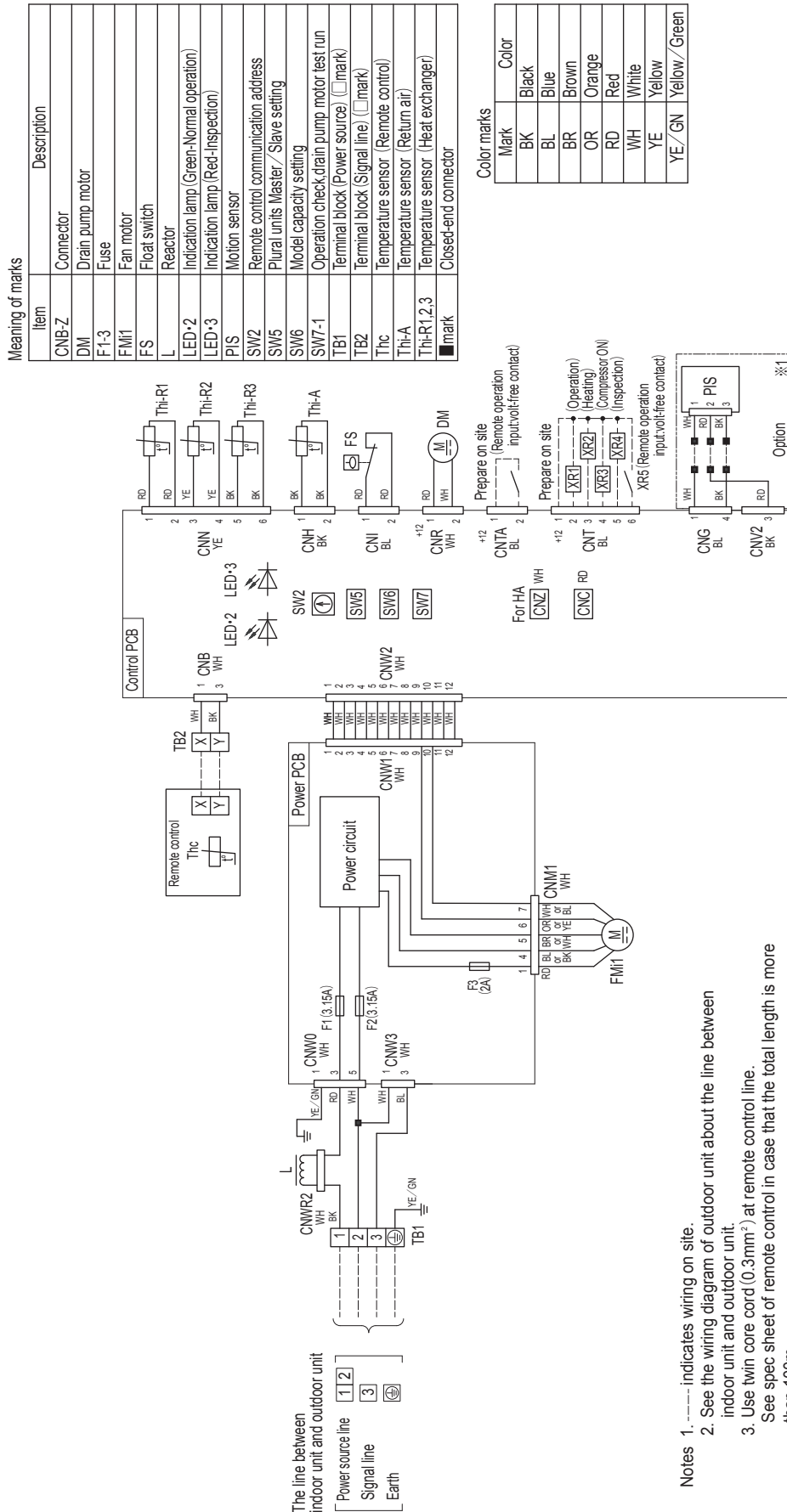

(6) Ceiling suspended type (FDE)
Model FDE50VH

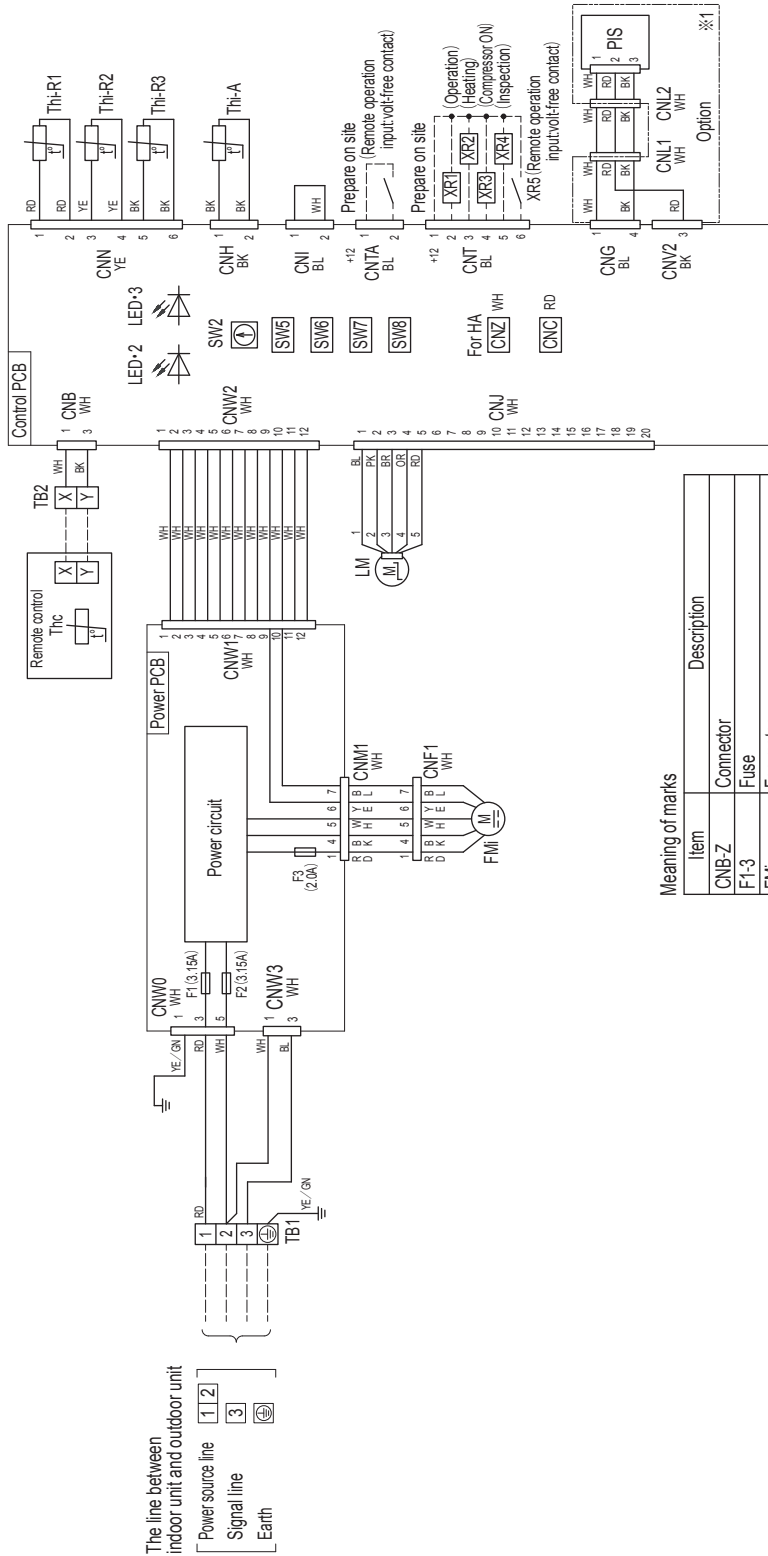

Color marks

Mark	Color
BK	Black
BL	Blue
BR	Brown
OR	Orange
PK	Pink
RD	Red
WH	White
YE	Yellow
YE/GN	Yellow/Green

Meaning of marks

Item	Description
CNB-Z	Connector
F1-3	Fuse
FMI	Fan motor
L	Reactor
LED-2	Indication lamp (Green-Normal operation)
LED-3	Indication lamp (Red-Inspection)
LM	Lower motor
PIS	Motion sensor
SW2	Remote control communication address
SW5	Plural units Master/ Slave setting
SW6	Model capacity setting
SW7-1	Operation check, drain pump motor test run
SW8-1	Anti-freeze control
TB1	Terminal block (Power source) (mark)
TB2	Terminal block (Signal line) (mark)
Thc	Temperature sensor (Remote control)
Thi-A	Temperature sensor (Return air)
Thi-R1,2,3	Temperature sensor (Heat exchanger)

- Notes
1. ----- indicates wiring on site.
 2. See the wiring diagram of outdoor unit about the line between indoor unit and outdoor unit.
 3. Use twin core cord (0.3mm²) at remote control line.
See spec sheet of remote control in case that the total length is more than 100m.
 4. Do not put remote control line alongside power source line.
 5. Section 1 (※1) shows electric circuit of motion sensor (Option).

2.4 NOISE LEVEL

(1) Wall mounted type (SRK, SKM)

(a) SRK - ZSX series

(i) Sound power level

Model SRK20ZSX-W, -WB, -WT

(Indoor unit)

Model	SRK20ZSX-W, -WB, -WT	
Noise Level	Cooling	53 dB(A)
	Heating	55 dB(A)

Condition	ISO15042 T1/H1
-----------	----------------

MODE	Rated capacity value (Hi)
------	---------------------------

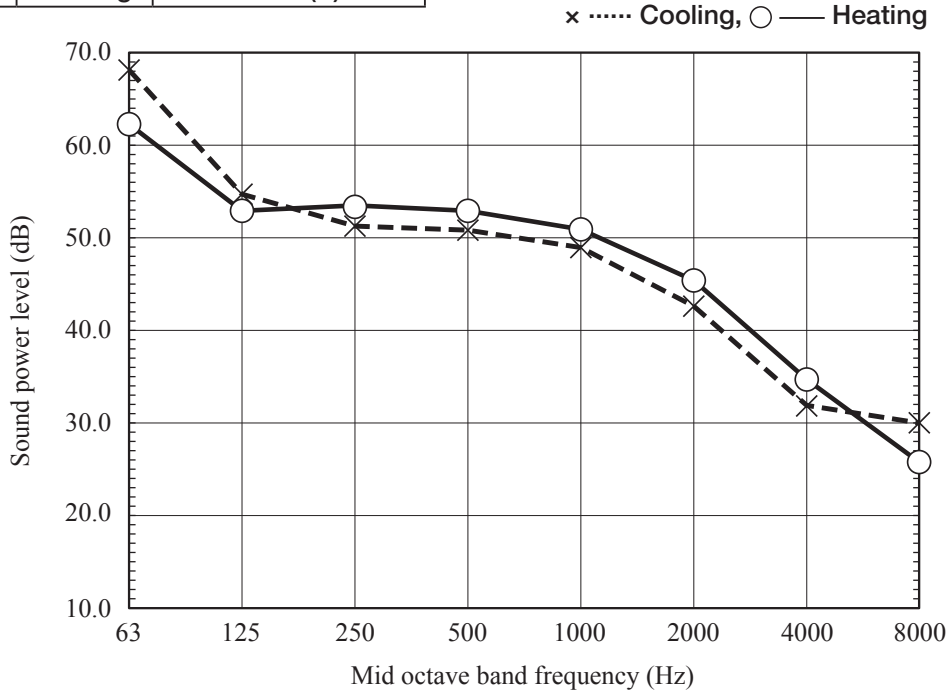

Model SRK25ZSX-W, -WB, -WT

(Indoor unit)

Model	SRK25ZSX-W, -WB, -WT	
Noise Level	Cooling	55 dB(A)
	Heating	56 dB(A)

Condition	ISO15042 T1/H1
-----------	----------------

MODE	Rated capacity value (Hi)
------	---------------------------

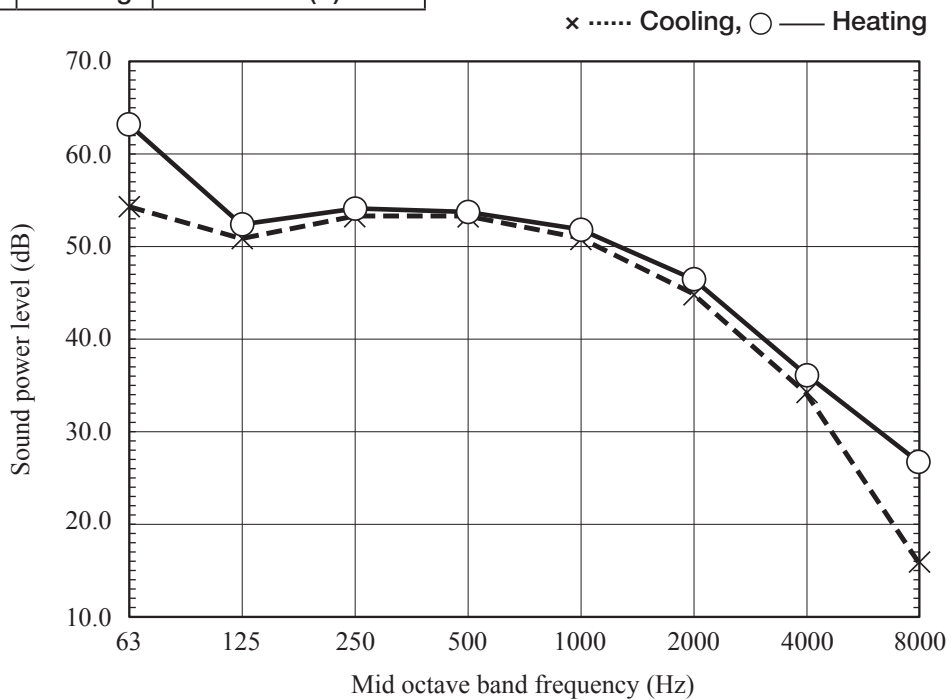

Model SRK35ZSX-W, -WB, -WT

(Indoor unit)

Model	SRK35ZSX-W, -WB, -WT	
Noise Level	Cooling	58 dB(A)
	Heating	58 dB(A)

Condition	ISO15042 T1/H1
MODE	Rated capacity value (Hi)

x Cooling, ○ — Heating

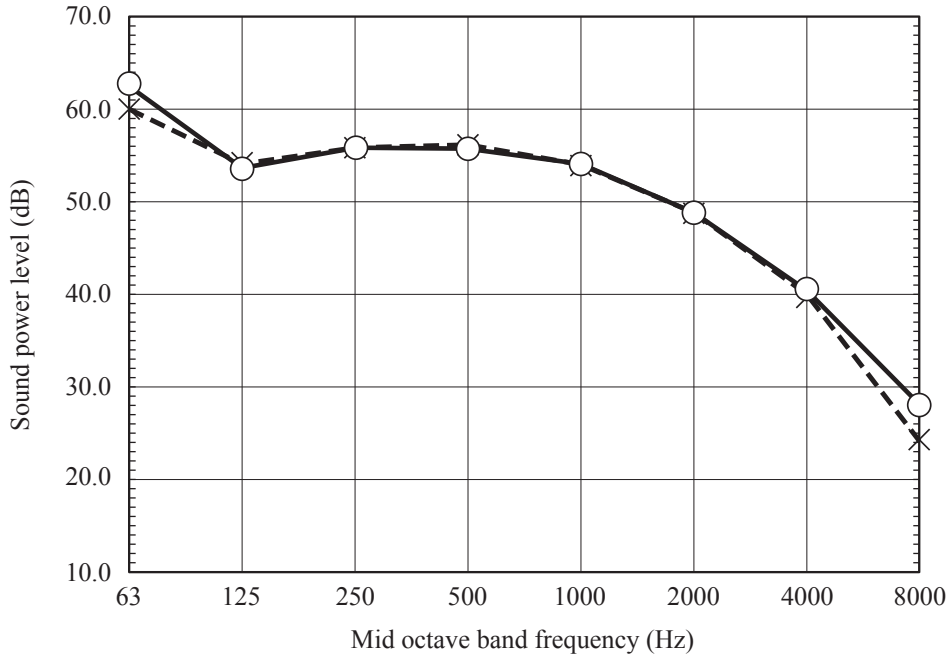

Model SRK50ZSX-W, -WB, -WT

(Indoor unit)

Model	SRK50ZSX-W, -WB, -WT	
Noise Level	Cooling	59 dB(A)
	Heating	62 dB(A)

Condition	ISO15042 T1/H1
MODE	Rated capacity value (Hi)

x Cooling, ○ — Heating

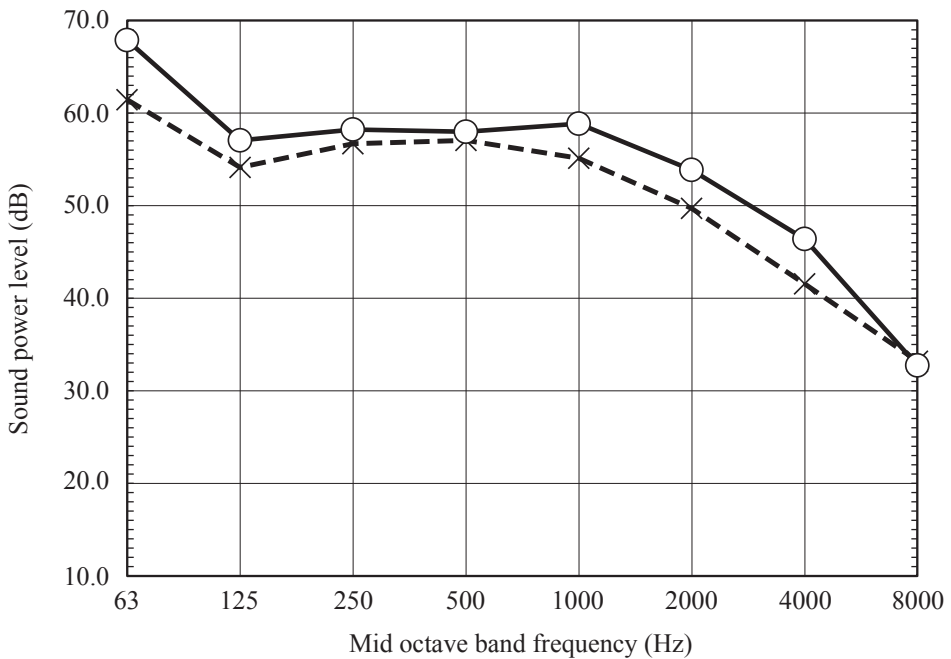

Model SRK60ZSX-W, -WB, -WT

(Indoor unit)

Model	SRK60ZSX-W, -WB, -WT	
Noise Level	Cooling	62 dB(A)
	Heating	63 dB(A)

Condition	ISO15042 T1/H1
MODE	Rated capacity value (Hi)

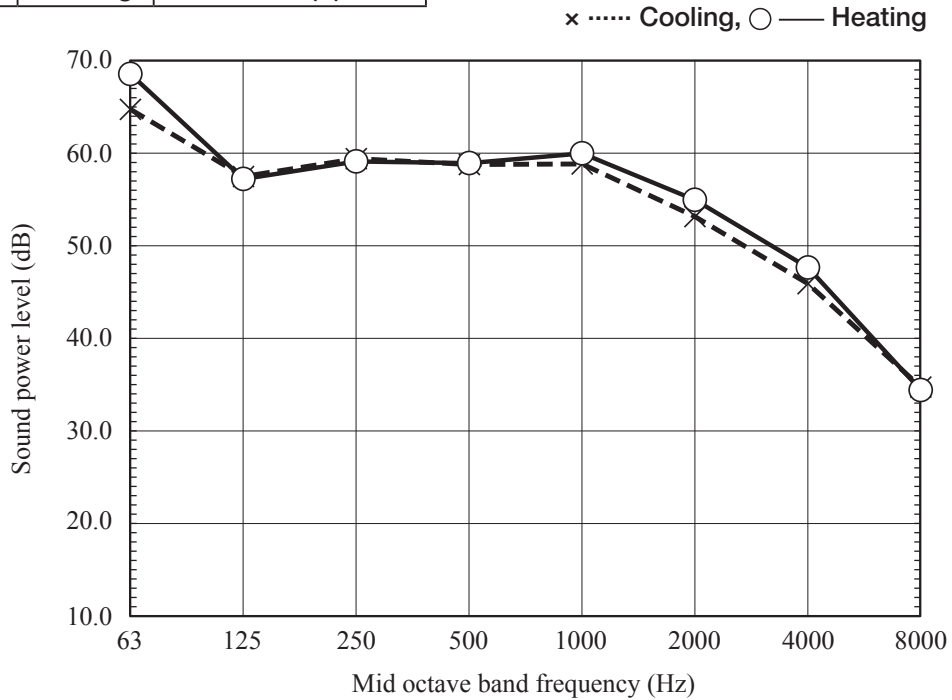

(ii) Sound pressure level

1) Rated capacity value

Model SRK20ZSX-W, -WB, -WT

(Indoor unit)

Model	SRK20ZSX-W, -WB, -WT	
Noise Level	Cooling	38 dB(A)
	Heating	38 dB(A)

Condition	ISO15042 T1/H1
MODE	Rated capacity value (Hi)

● Mike position

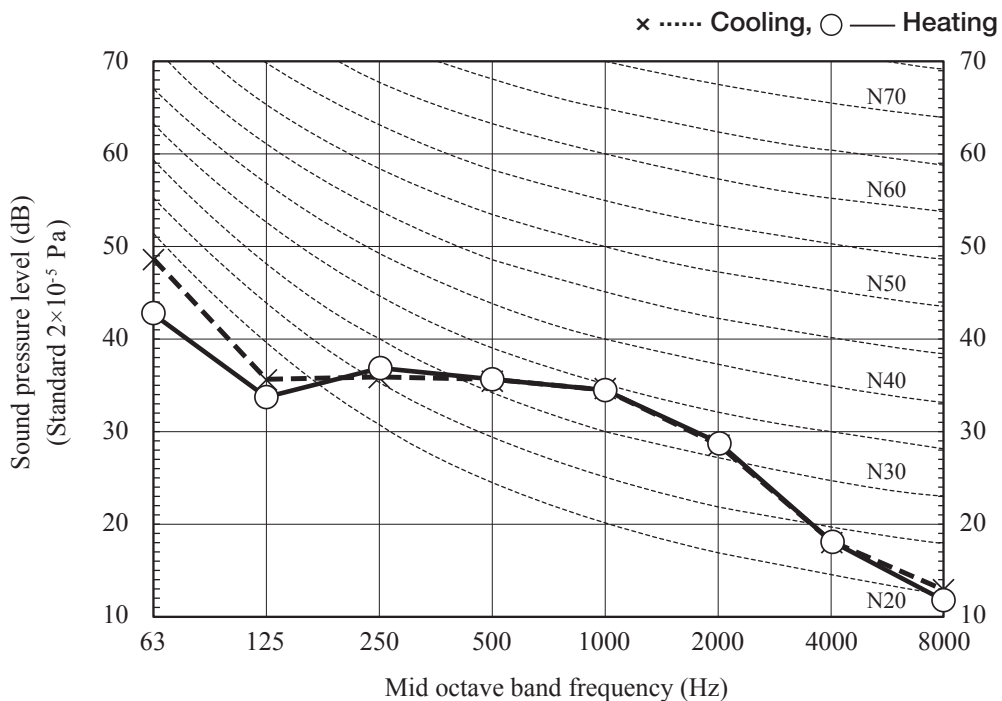

Model SRK25ZSX-W, -WB, -WT

(Indoor unit)

Model	SRK25ZSX-W, -WB, -WT	
Noise Level	Cooling	39 dB(A)
	Heating	40 dB(A)

Condition	ISO15042 T1/H1
-----------	----------------

MODE	Rated capacity value (Hi)
------	---------------------------

●Mike position



x Cooling, ○ — Heating

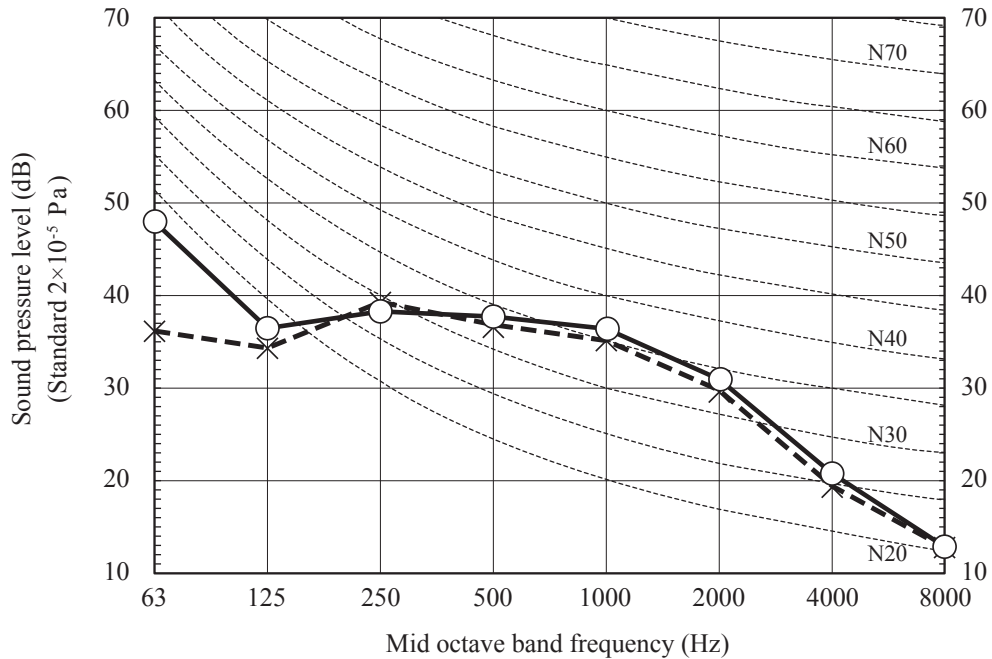

Model SRK35ZSX-W, -WB, -WT

(Indoor unit)

Model	SRK35ZSX-W, -WB, -WT	
Noise Level	Cooling	43 dB(A)
	Heating	42 dB(A)

Condition	ISO15042 T1/H1
-----------	----------------

MODE	Rated capacity value (Hi)
------	---------------------------

●Mike position

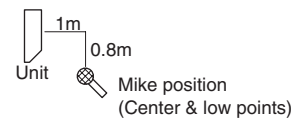

x Cooling, ○ — Heating

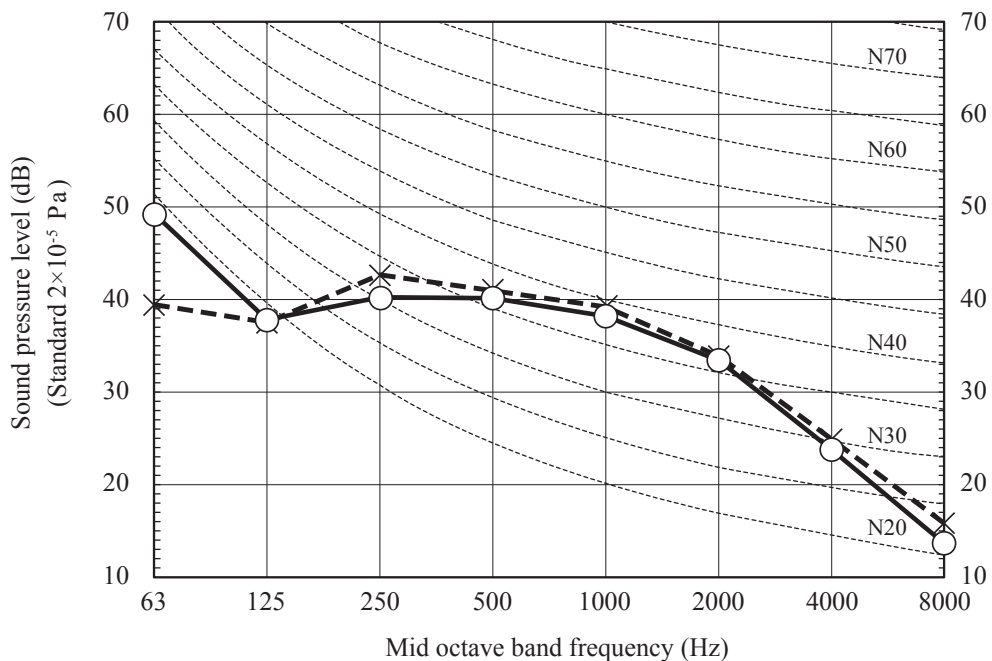

Model SRK50ZSX-W, -WB, -WT
(Indoor unit)

Model	SRK50ZSX-W, -WB, -WT	
Noise Level	Cooling	44 dB(A)
	Heating	47 dB(A)

Condition	ISO15042 T1/H1
-----------	----------------

MODE	Rated capacity value (Hi)
------	---------------------------

●Mike position



x Cooling, ○ — Heating

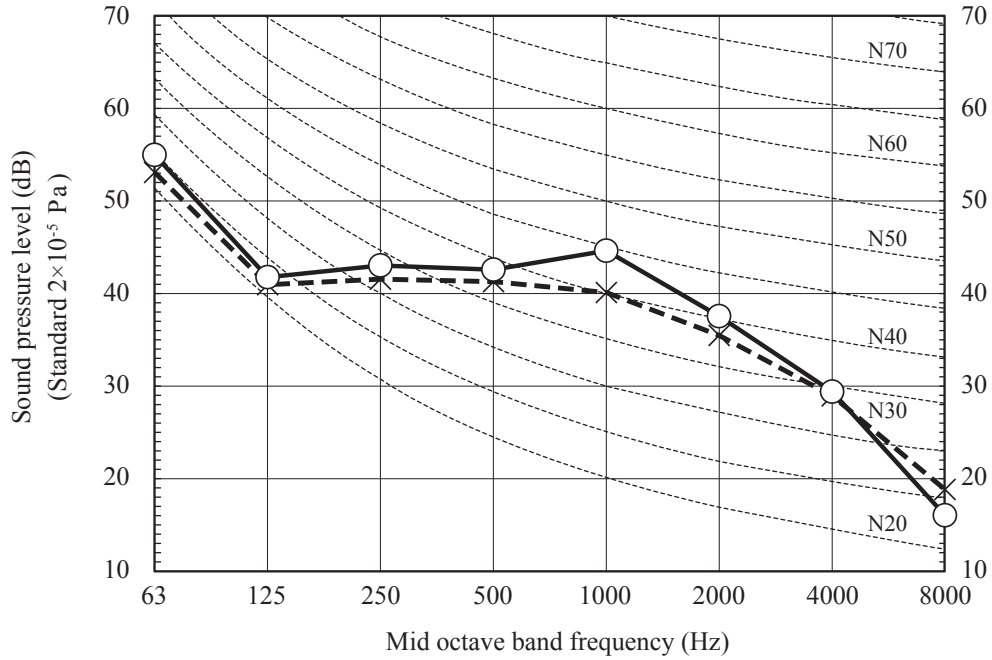

Model SRK60ZSX-W, -WB, -WT

(Indoor unit)

Model	SRK60ZSX-W, -WB, -WT	
Noise Level	Cooling	48 dB(A)
	Heating	47 dB(A)

Condition	ISO15042 T1/H1
-----------	----------------

MODE	Rated capacity value (Hi)
------	---------------------------

●Mike position



x Cooling, ○ — Heating

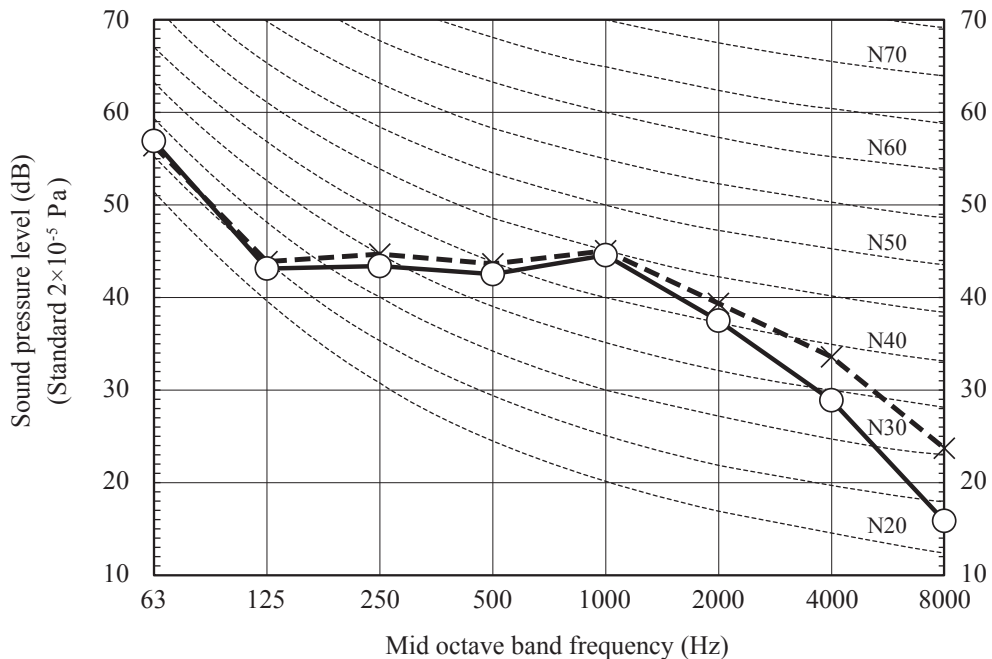

2) Each fan speed mode
Model SRK20ZSX-W, -WB, -WT

(Indoor unit)

Model	SRK20ZSX-W, -WB, -WT	
Noise	Cooling	31 dB(A)
Level	Heating	33 dB(A)

Condition	ISO15042 T1/H1
-----------	----------------

MODE	Me
------	----

●Mike position



x Cooling, ○ — Heating

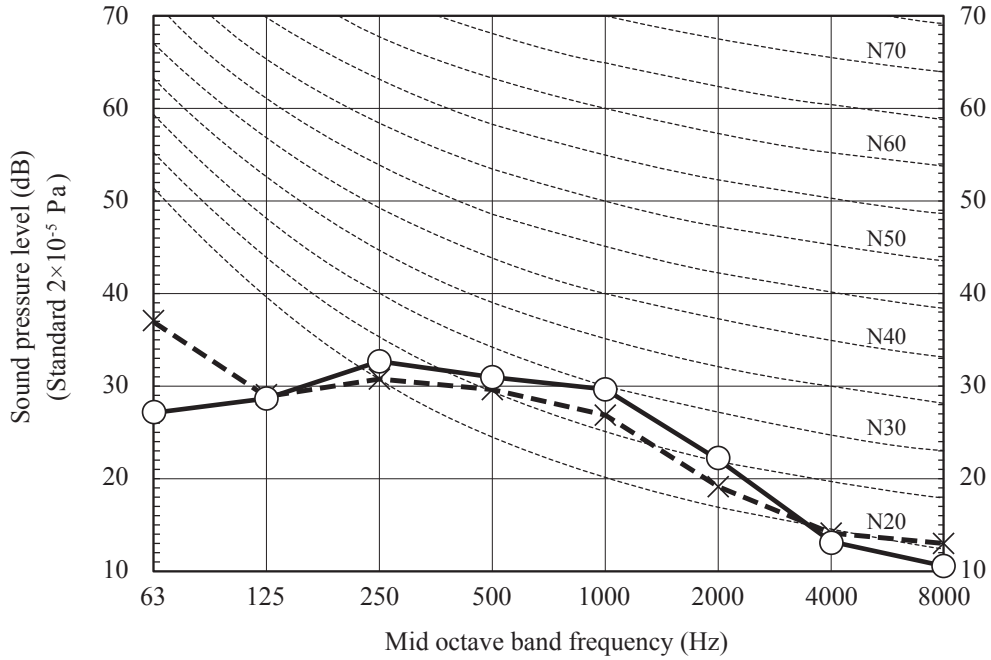

(Indoor unit)

Model	SRK20ZSX-W, -WB, -WT	
Noise	Cooling	24 dB(A)
Level	Heating	25 dB(A)

Condition	ISO15042 T1/H1
-----------	----------------

MODE	Lo
------	----

●Mike position



x Cooling, ○ — Heating

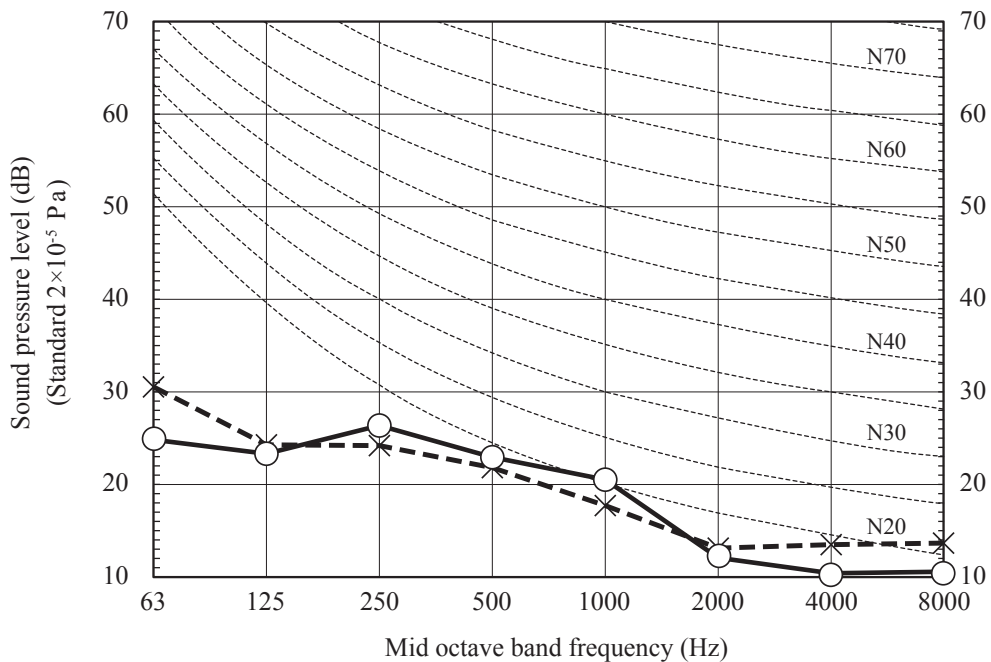

(Indoor unit)

Model	SRK20ZSX-W, -WB, -WT	
Noise Level	Cooling	19 dB(A)
	Heating	19 dB(A)

Condition	ISO15042 T1/H1
MODE	ULo

●Mike position



x Cooling, ○ — Heating

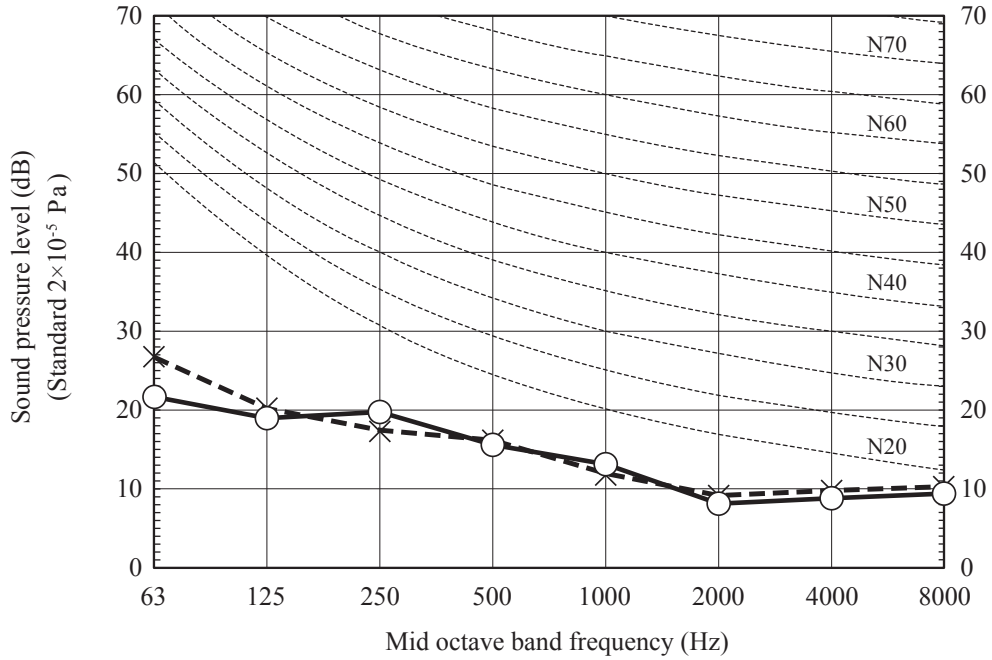

Model SRK25ZSX-W, -WB, -WT

(Indoor unit)

Model	SRK25ZSX-W, -WB, -WT	
Noise Level	Cooling	33 dB(A)
	Heating	34 dB(A)

Condition	ISO15042 T1/H1
MODE	Me

●Mike position



x Cooling, ○ — Heating

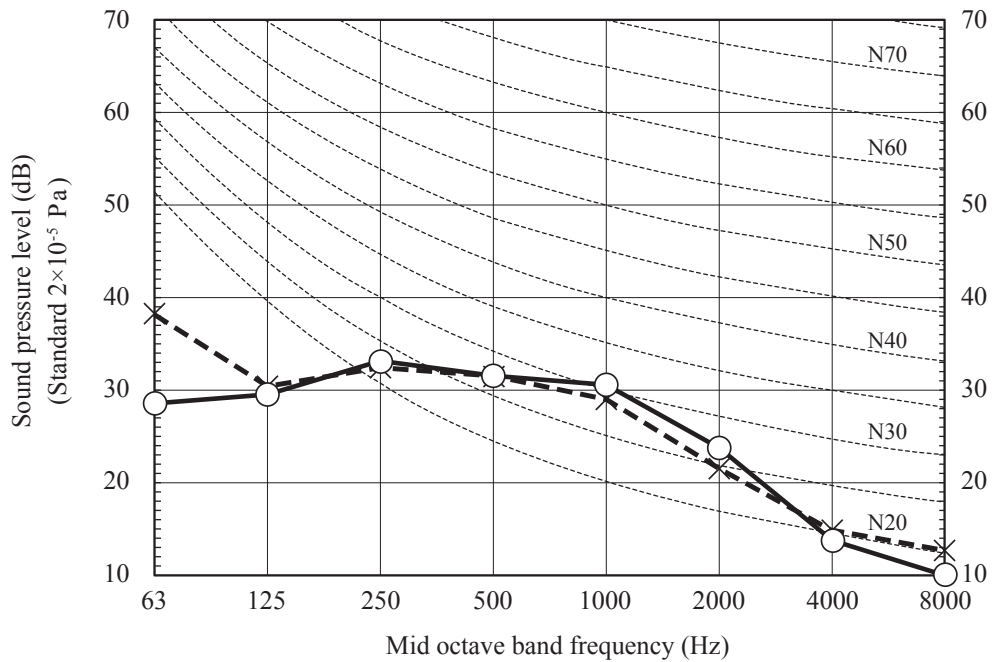

(Indoor unit)

Model	SRK25ZSX-W, -WB, -WT	
Noise Level	Cooling	25 dB(A)
	Heating	27 dB(A)

Condition	ISO15042 T1/H1
MODE	Lo

●Mike position



x Cooling, ○ — Heating

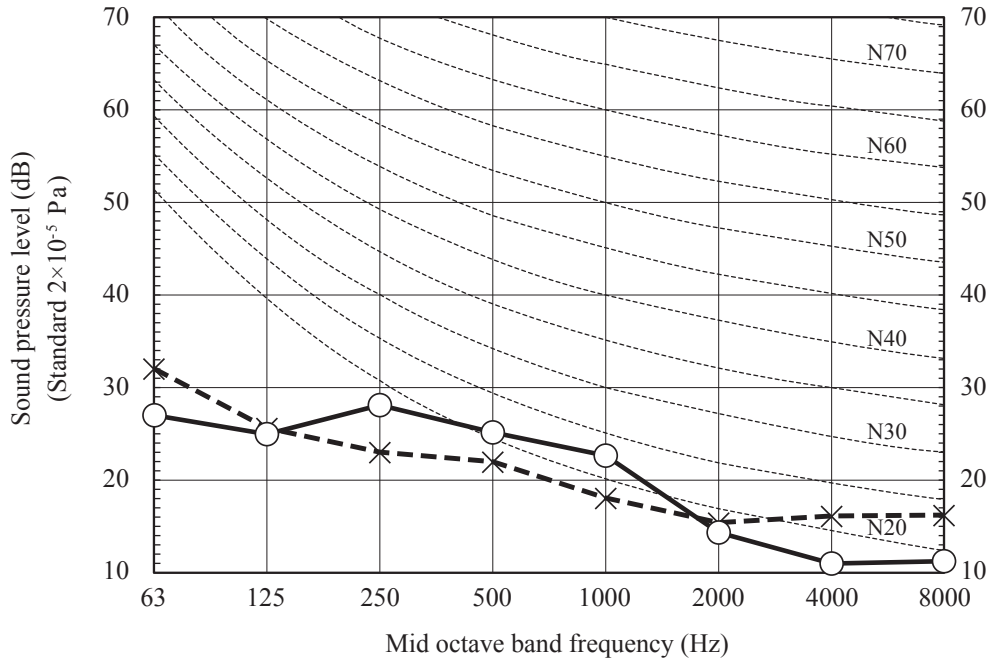

(Indoor unit)

Model	SRK25ZSX-W, -WB, -WT	
Noise Level	Cooling	19 dB(A)
	Heating	19 dB(A)

Condition	ISO15042 T1/H1
MODE	ULo

●Mike position



x Cooling, ○ — Heating

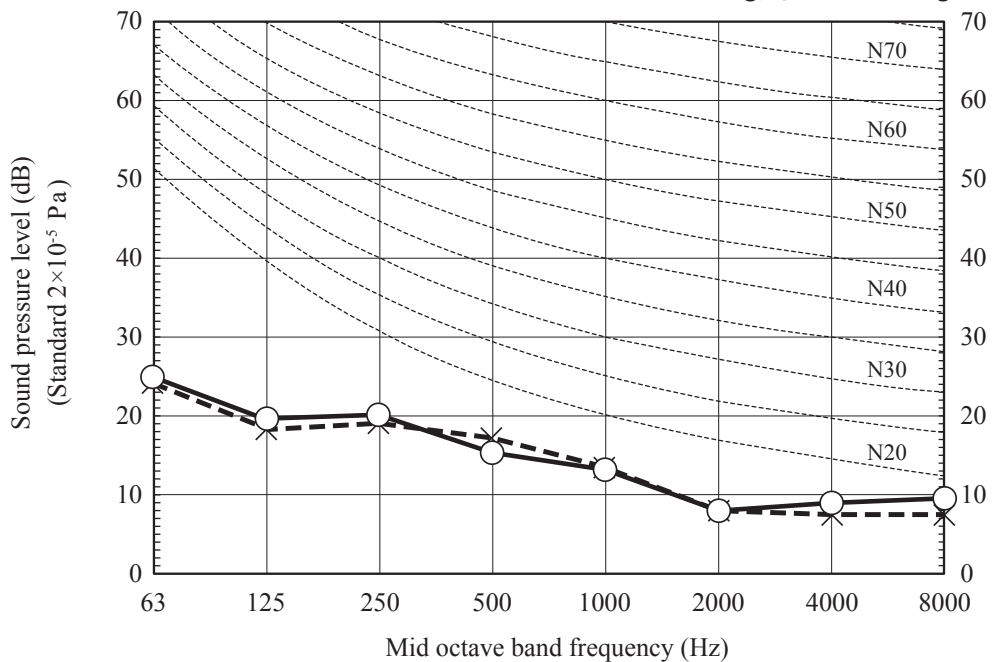

Model SRK35ZSX-W, -WB, -WT

(Indoor unit)

Model	SRK35ZSX-W, -WB, -WT	
Noise Level	Cooling	35 dB(A)
	Heating	35 dB(A)

Condition	ISO15042 T1/H1
MODE	Me

●Mike position



x Cooling, ○ — Heating

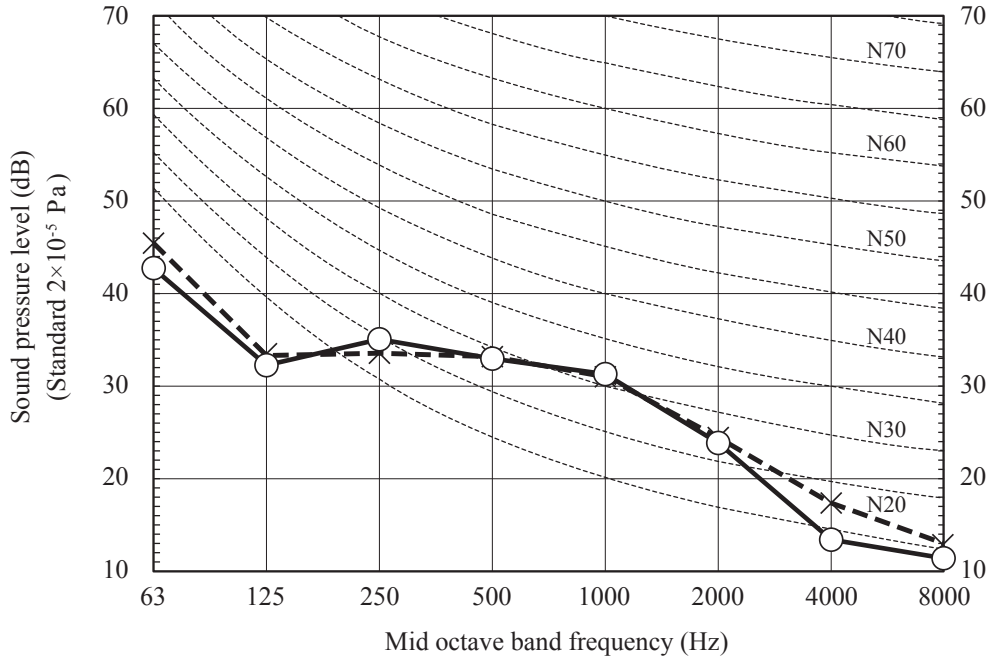

(Indoor unit)

Model	SRK35ZSX-W, -WB, -WT	
Noise Level	Cooling	26 dB(A)
	Heating	28 dB(A)

Condition	ISO15042 T1/H1
MODE	Lo

●Mike position



x Cooling, ○ — Heating

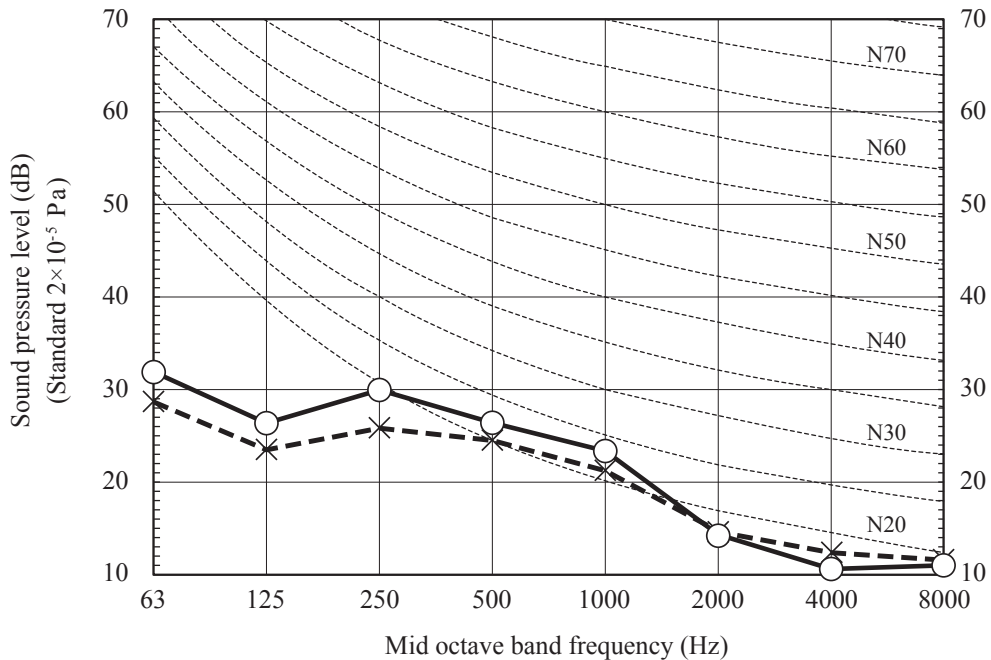

(Indoor unit)

Model	SRK35ZSX-W, -WB, -WT	
Noise Level	Cooling	19 dB(A)
	Heating	19 dB(A)

Condition	ISO15042 T1/H1
MODE	ULo

●Mike position



x Cooling, ○ — Heating

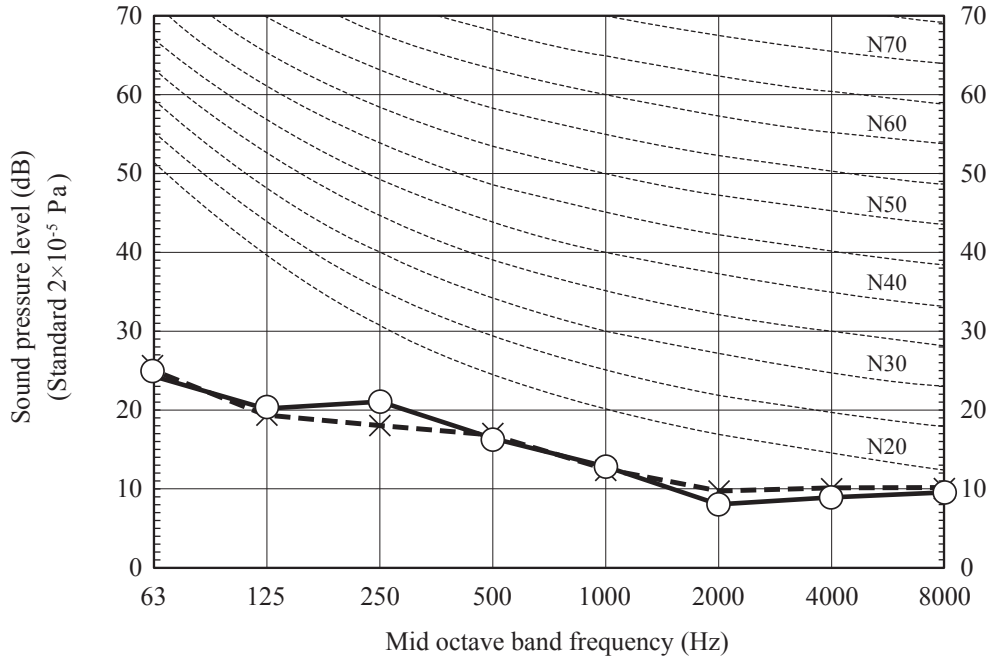

Model SRK50ZSX-W, -WB, -WT

(Indoor unit)

Model	SRK50ZSX-W, -WB, -WT	
Noise Level	Cooling	39 dB(A)
	Heating	41 dB(A)

Condition	ISO15042 T1/H1
MODE	Me

●Mike position



x Cooling, ○ — Heating

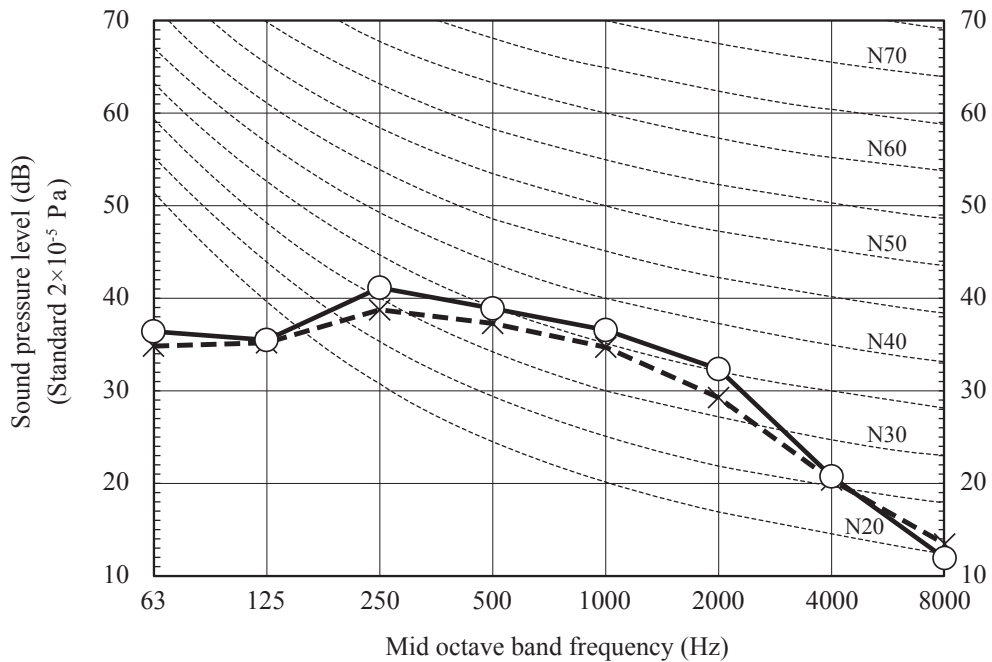

(Indoor unit)

Model	SRK50ZSX-W, -WB, -WT	
Noise Level	Cooling	31 dB(A)
	Heating	33 dB(A)

Condition	ISO15042 T1/H1
MODE	Lo

●Mike position



x Cooling, ○ — Heating

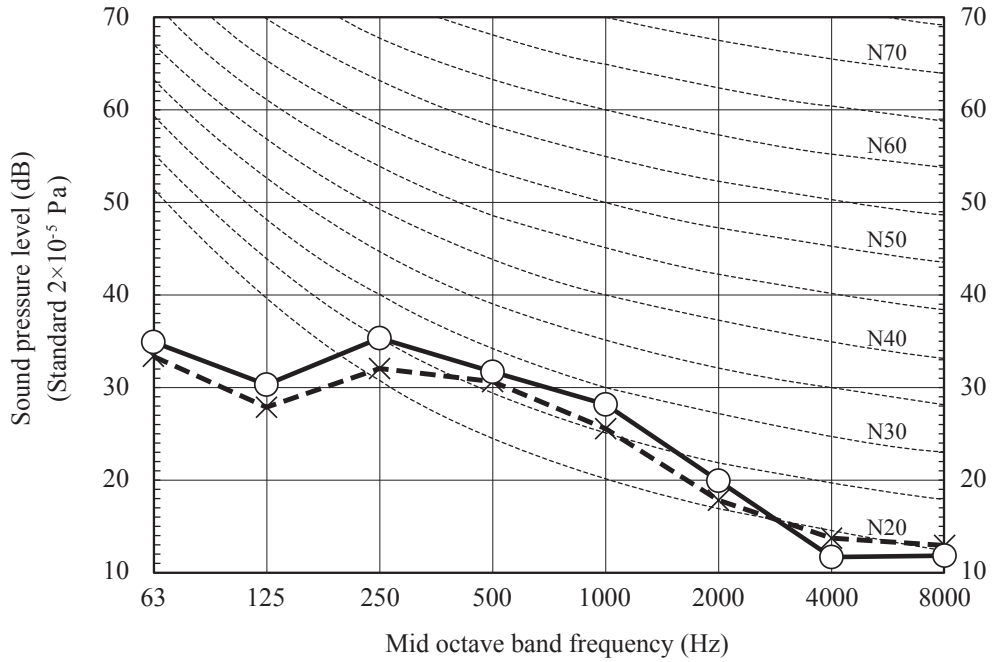

(Indoor unit)

Model	SRK50ZSX-W, -WB, -WT	
Noise Level	Cooling	22 dB(A)
	Heating	23 dB(A)

Condition	ISO15042 T1/H1
MODE	ULo

●Mike position



x Cooling, ○ — Heating

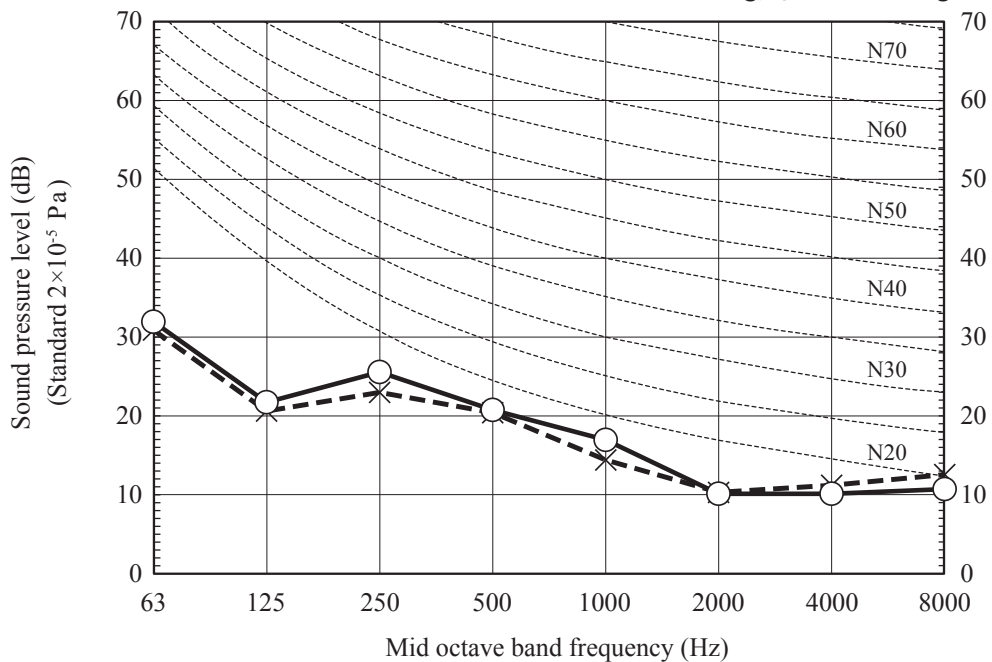

Model SRK60ZSX-W, -WB, -WT

(Indoor unit)

Model	SRK60ZSX-W, -WB, -WT	
Noise Level	Cooling	41 dB(A)
	Heating	42 dB(A)

Condition	ISO15042 T1/H1
-----------	----------------

MODE	Me
------	----

●Mike position



x Cooling, ○ — Heating

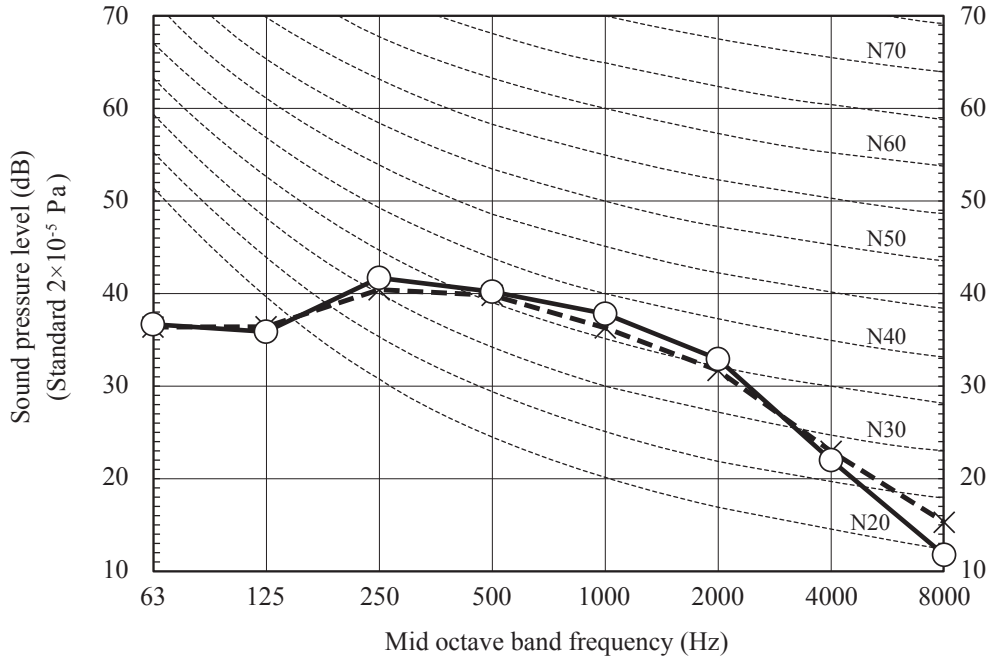

(Indoor unit)

Model	SRK60ZSX-W, -WB, -WT	
Noise Level	Cooling	33 dB(A)
	Heating	34 dB(A)

Condition	ISO15042 T1/H1
-----------	----------------

MODE	Lo
------	----

●Mike position



x Cooling, ○ — Heating

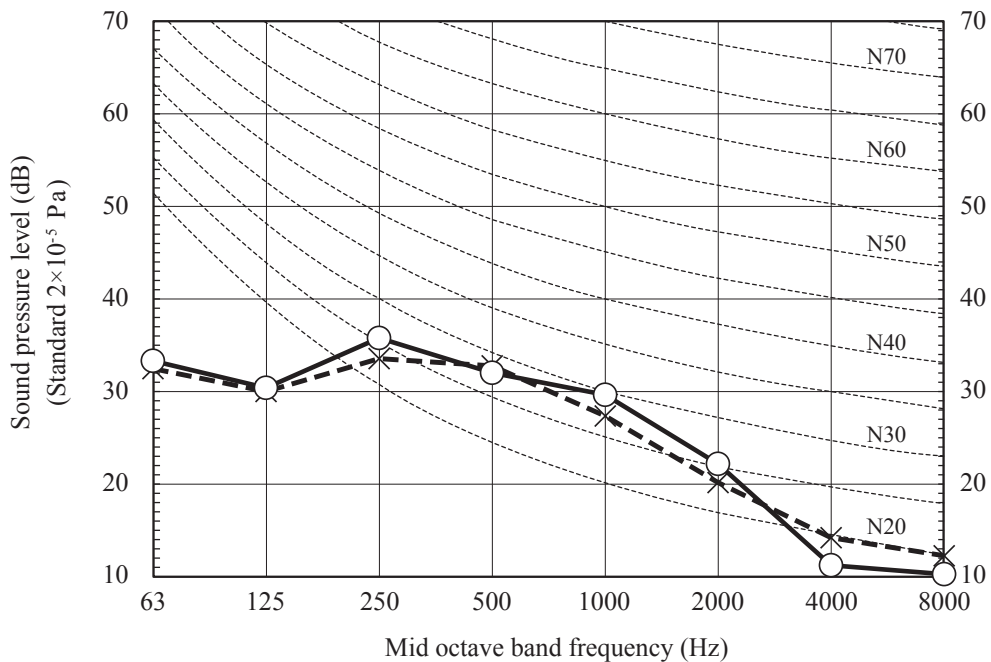

(Indoor unit)

Model	SRK60ZSX-W, -WB, -WT	
Noise Level	Cooling	22 dB(A)
	Heating	23 dB(A)

Condition	ISO15042 T1/H1
MODE	ULo

●Mike position



x Cooling, ○ — Heating

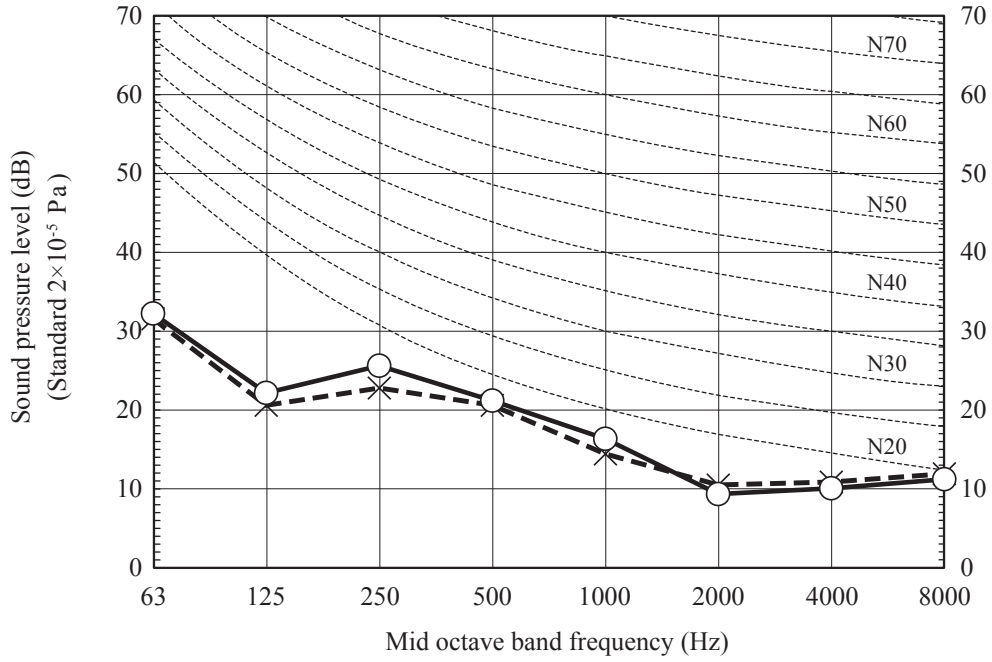

(b) SRK-ZS series

(i) Sound power level

Model SRK20ZS-W, -WB, -WT

(Indoor unit)

Model	SRK20ZS-W, WB, WT	
Noise Level	Cooling	48 dB(A)
	Heating	50 dB(A)

Condition	ISO15042 T1/H1
-----------	----------------

MODE	Rated capacity value (Hi)
------	---------------------------

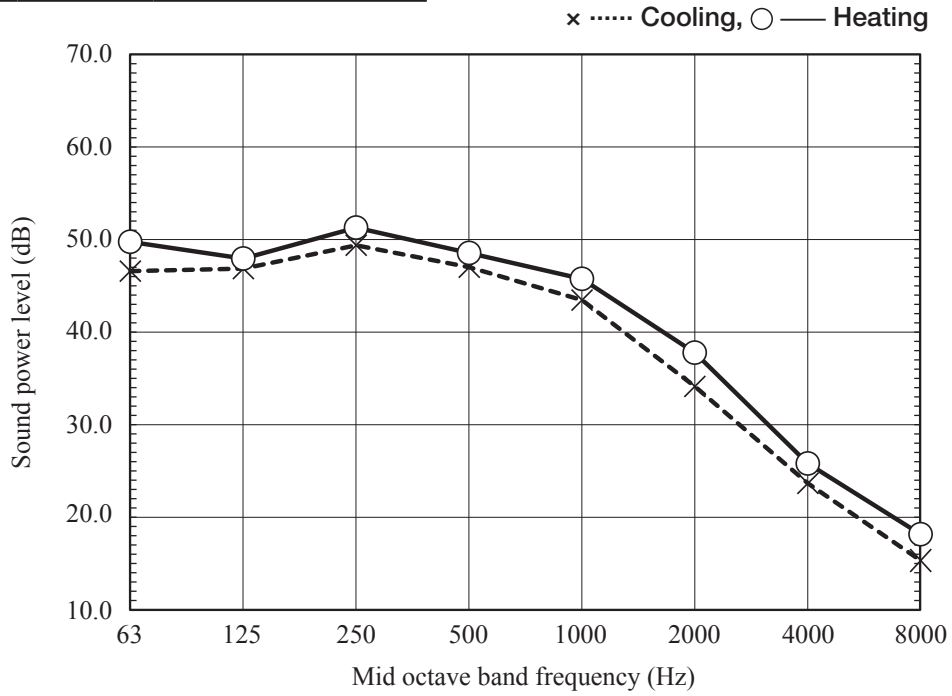

Model SRK25ZS-W, -WB, -WT

(Indoor unit)

Model	SRK25ZS-W, WB, WT	
Noise Level	Cooling	50 dB(A)
	Heating	53 dB(A)

Condition	ISO15042 T1/H1
-----------	----------------

MODE	Rated capacity value (Hi)
------	---------------------------

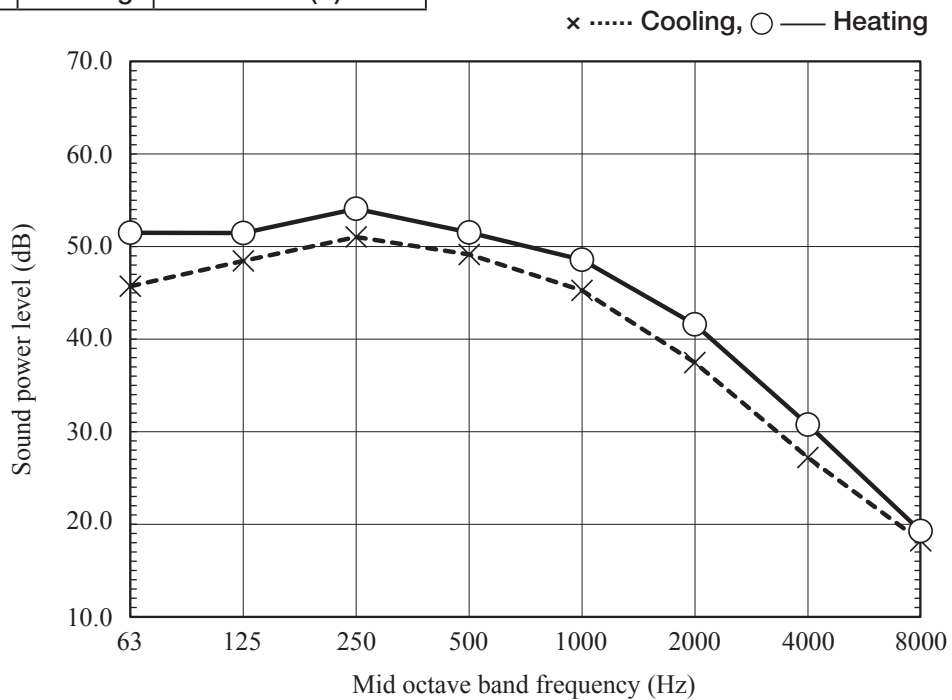

Model SRK35ZS-W, -WB, -WT

(Indoor unit)

Model	SRK35ZS-W, WB, WT	
Noise Level	Cooling	54 dB(A)
	Heating	56 dB(A)

Condition	ISO15042 T1/H1
-----------	----------------

MODE	Rated capacity value (Hi)
------	---------------------------

x Cooling, ○ — Heating

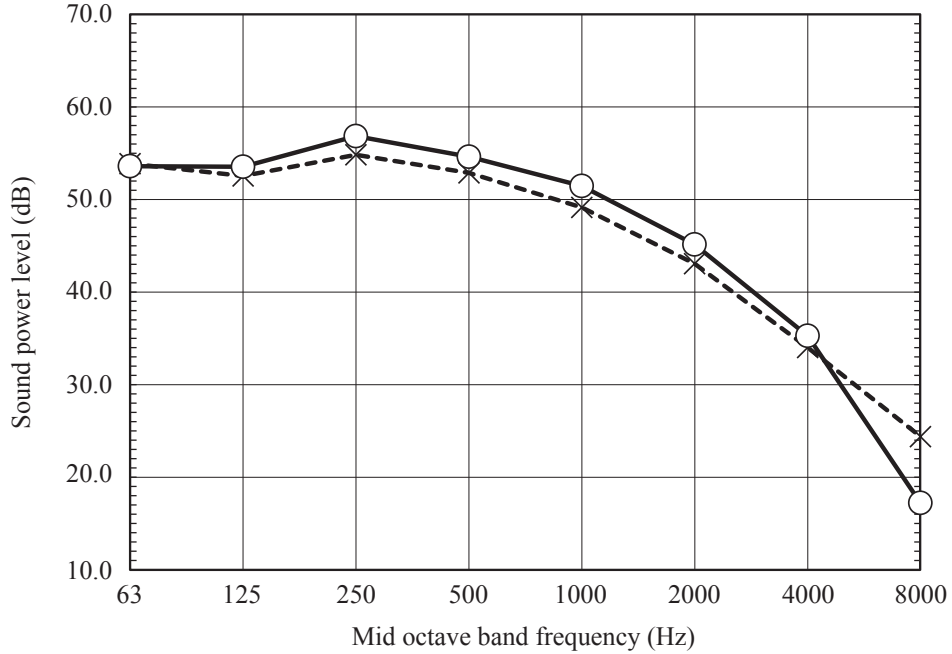

Model SRK50ZS-W, -WB, -WT

(Indoor unit)

Model	SRK50ZS-W, WB, WT	
Noise Level	Cooling	59 dB(A)
	Heating	60 dB(A)

Condition	ISO15042 T1/H1
-----------	----------------

MODE	Rated capacity value (Hi)
------	---------------------------

x Cooling, ○ — Heating

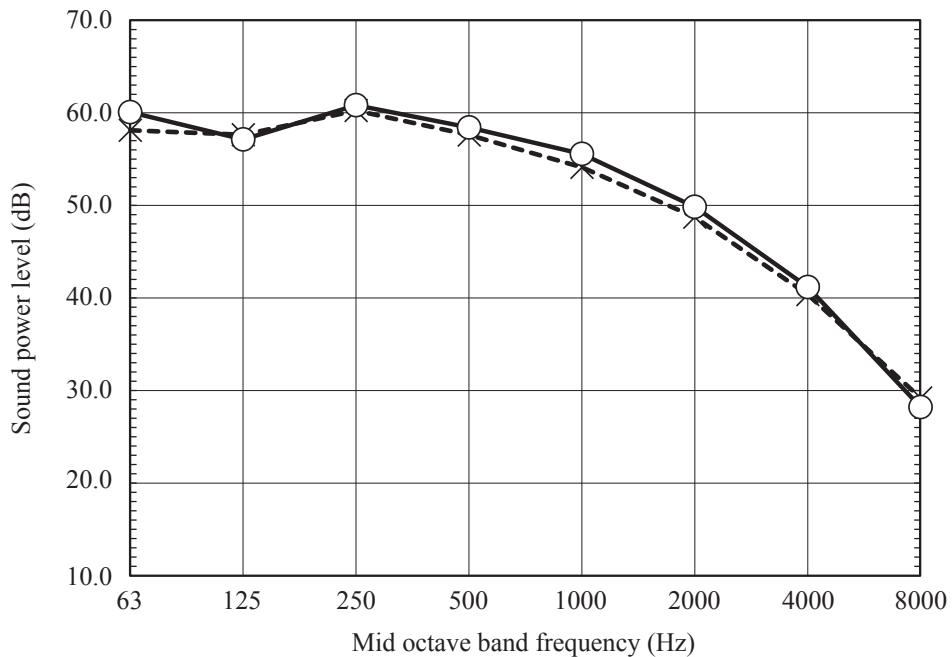

(ii) Sound pressure level

1) Rated capacity value

Model SRK20ZS-W, -WB, -WT

(Indoor unit)

Model	SRK20ZS-W, WB, WT	
Noise Level	Cooling	34 dB(A)
	Heating	36 dB(A)

Condition	ISO15042 T1/H1
-----------	----------------

MODE	Rated capacity value (Hi)
------	---------------------------

● Mike position



x Cooling, ○ — Heating

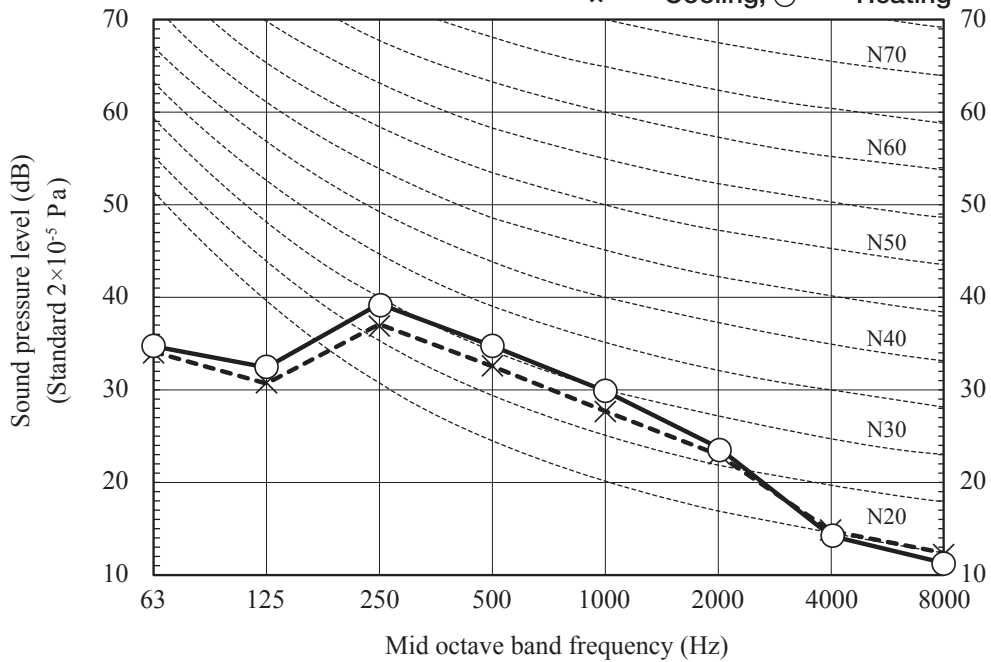

Model SRK25ZS-W, -WB, -WT

(Indoor unit)

Model	SRK25ZS-W, WB, WT	
Noise Level	Cooling	36 dB(A)
	Heating	39 dB(A)

Condition	ISO15042 T1/H1
-----------	----------------

MODE	Rated capacity value (Hi)
------	---------------------------

● Mike position



x Cooling, ○ — Heating

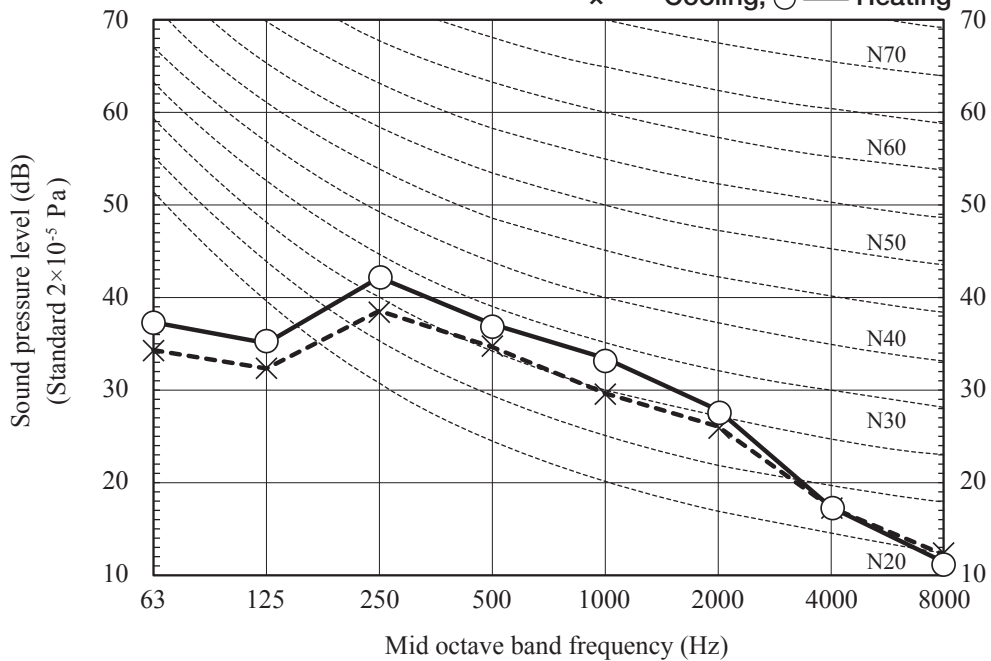

Model SRK35ZS-W, -WB, -WT

Condition	ISO15042 T1/H1
MODE	Rated capacity value (Hi)

(Indoor unit)

Model	SRK35ZS-W, WB, WT	
Noise Level	Cooling	40 dB(A)
	Heating	41 dB(A)

●Mike position



x Cooling, ○ — Heating

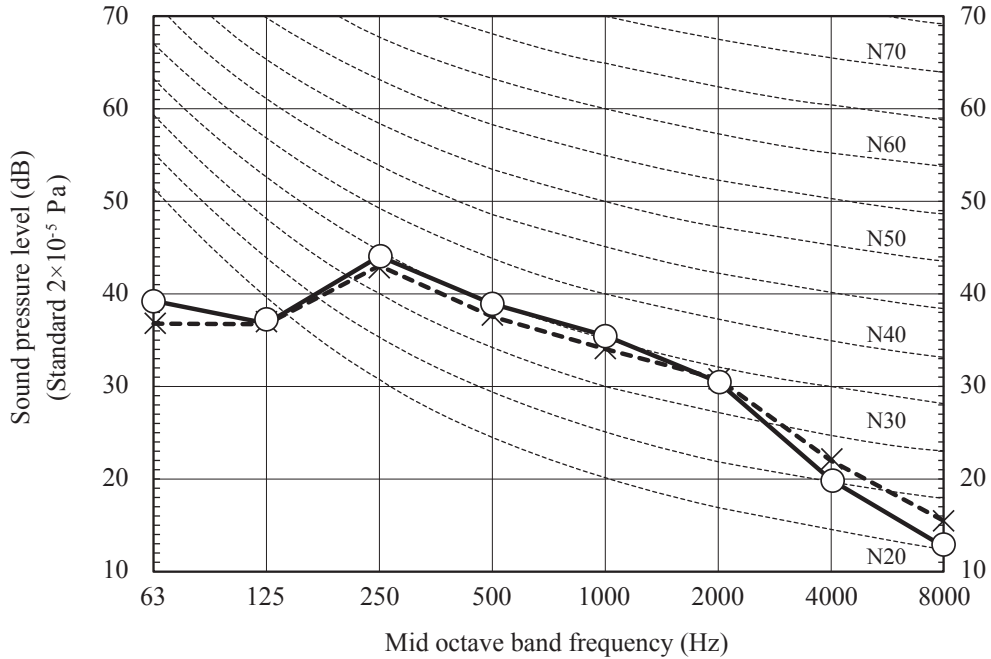

Model SRK50ZS-W, -WB, -WT

Condition	ISO15042 T1/H1
MODE	Rated capacity value (Hi)

(Indoor unit)

Model	SRK50ZS-W, WB, WT	
Noise Level	Cooling	46 dB(A)
	Heating	46 dB(A)

●Mike position



x Cooling, ○ — Heating

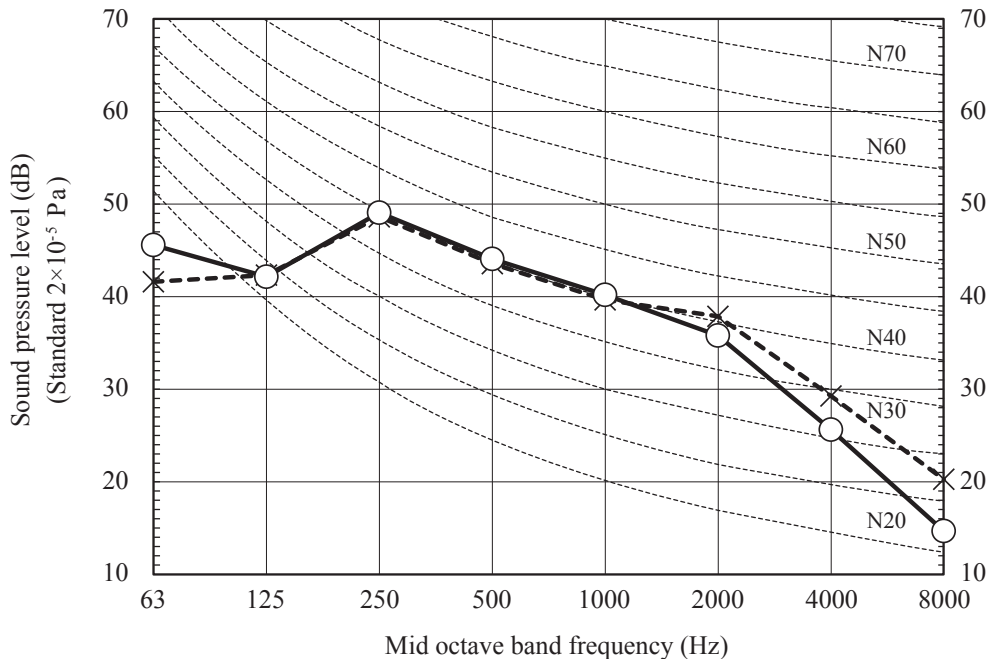

2) Each fan speed mode
Model SRK20ZS-W, -WB, -WT

(Indoor unit)

Model	SRK20ZS-W, WB, WT	
Noise	Cooling	25 dB(A)
Level	Heating	29 dB(A)

Condition	ISO15042 T1/H1
-----------	----------------

MODE	Me
------	----

●Mike position



x Cooling, ○ — Heating

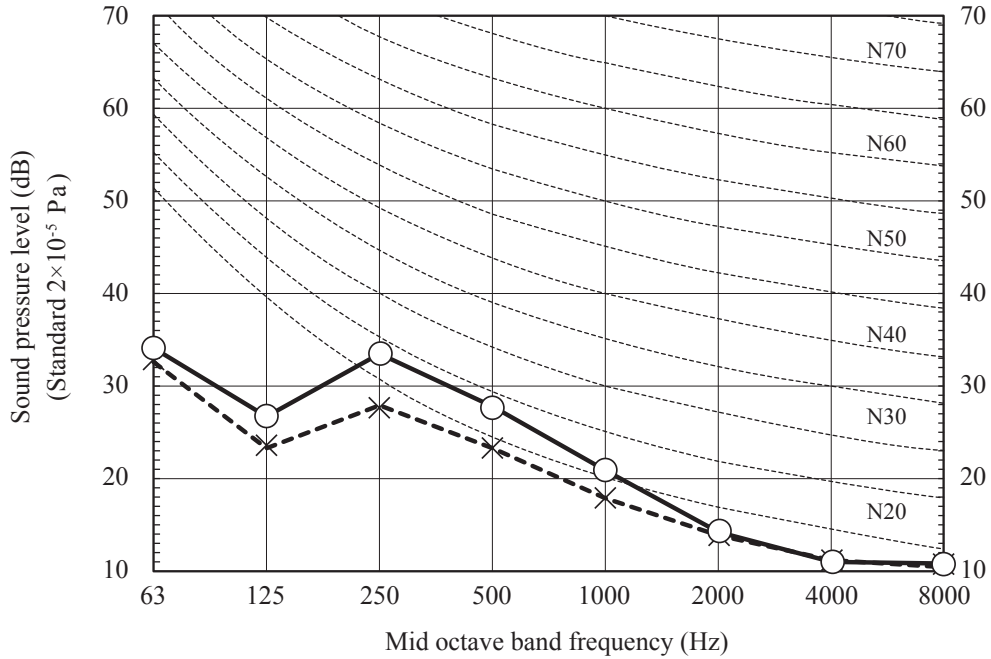

(Indoor unit)

Model	SRK20ZS-W, WB, WT	
Noise	Cooling	22 dB(A)
Level	Heating	23 dB(A)

Condition	ISO15042 T1/H1
-----------	----------------

MODE	Lo
------	----

●Mike position



x Cooling, ○ — Heating

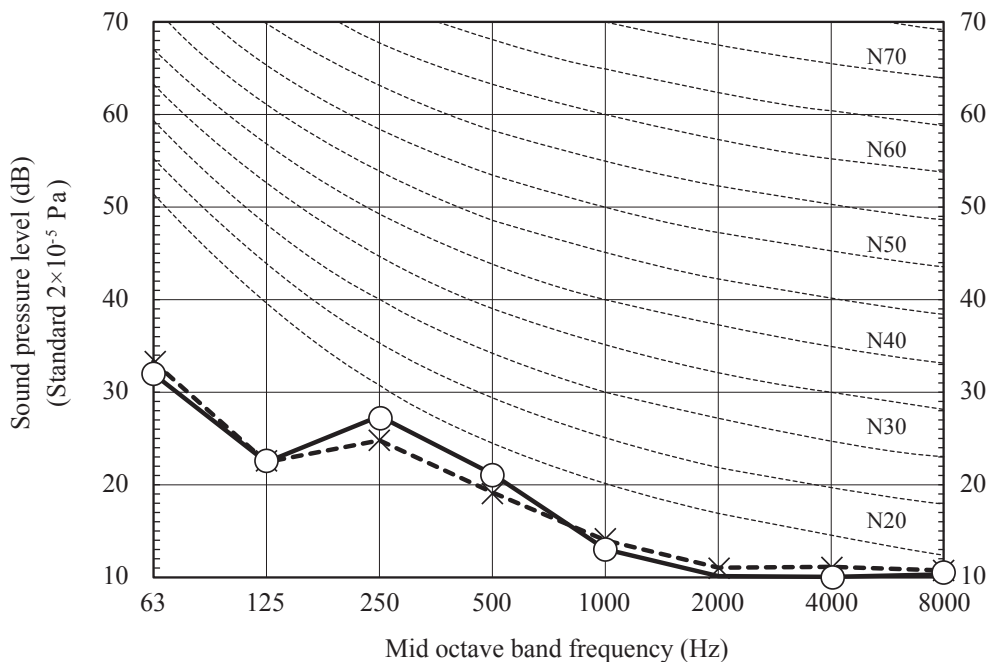

(Indoor unit)

Model	SRK20ZS-W, WB, WT	
Noise Level	Cooling	19 dB(A)
	Heating	19 dB(A)

Condition	ISO15042 T1/H1
-----------	----------------

MODE	ULo
------	-----

● Mike position



x Cooling, ○ — Heating

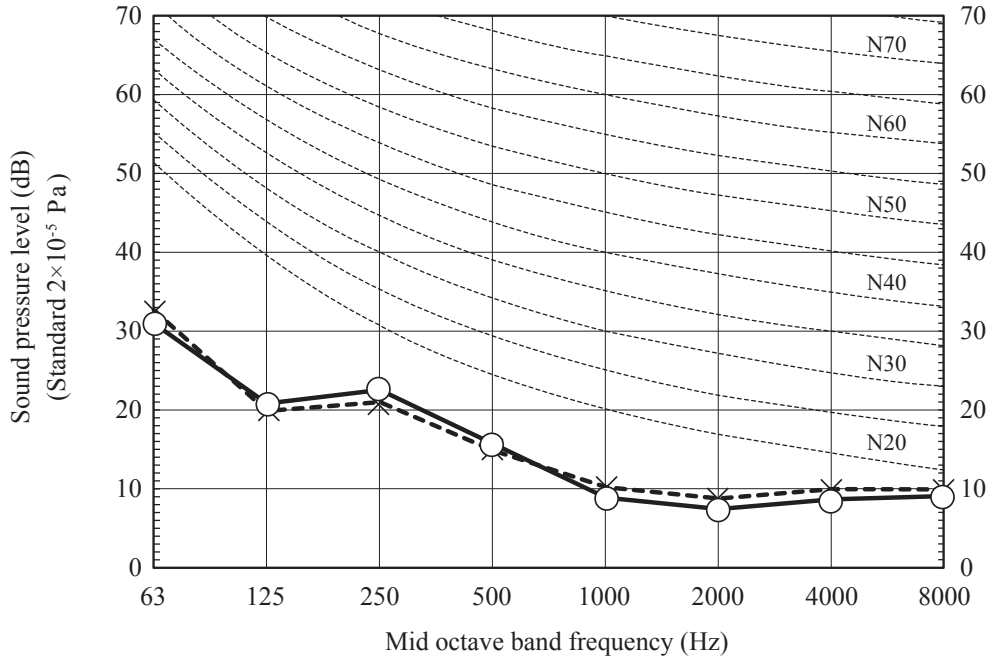

Model SRK25ZS-W, -WB, -WT

(Indoor unit)

Model	SRK25ZS-W, WB, WT	
Noise Level	Cooling	28 dB(A)
	Heating	30 dB(A)

Condition	ISO15042 T1/H1
-----------	----------------

MODE	Me
------	----

● Mike position



x Cooling, ○ — Heating

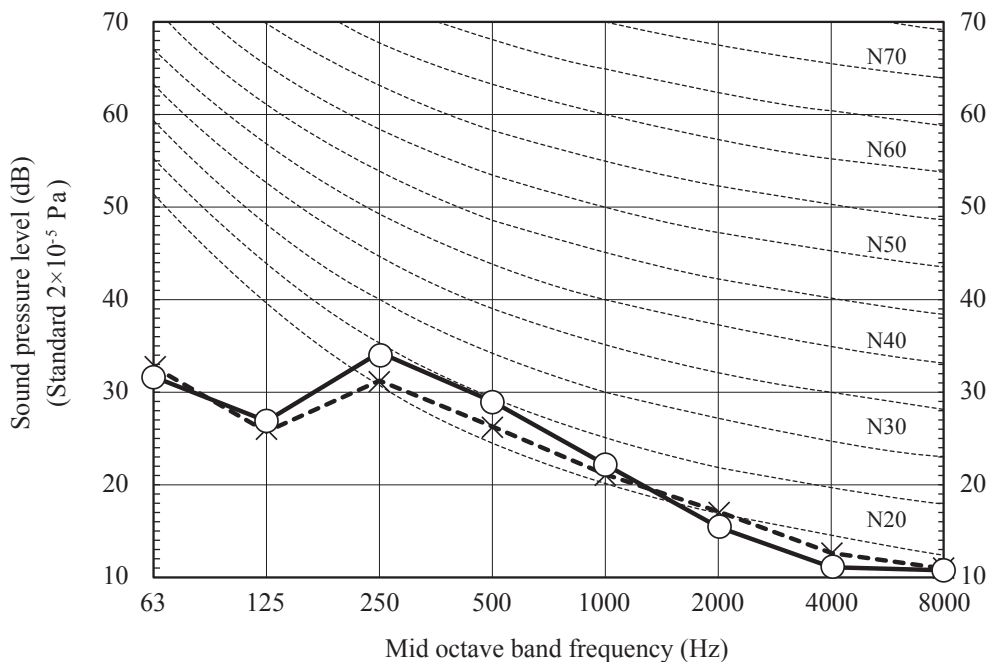

(Indoor unit)

Model	SRK25ZS-W, WB, WT	
Noise Level	Cooling	23 dB(A)
	Heating	24 dB(A)

Condition	ISO15042 T1/H1
-----------	----------------

MODE	Lo
------	----

● Mike position



x Cooling, ○ — Heating

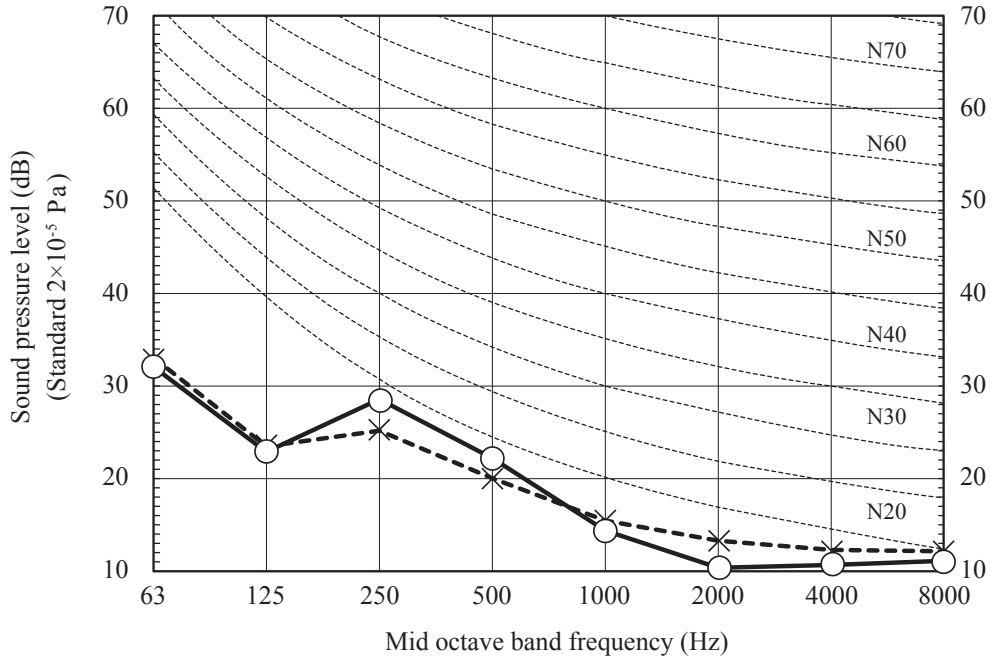

(Indoor unit)

Model	SRK25ZS-W, WB, WT	
Noise Level	Cooling	19 dB(A)
	Heating	19 dB(A)

Condition	ISO15042 T1/H1
-----------	----------------

MODE	ULo
------	-----

● Mike position



x Cooling, ○ — Heating

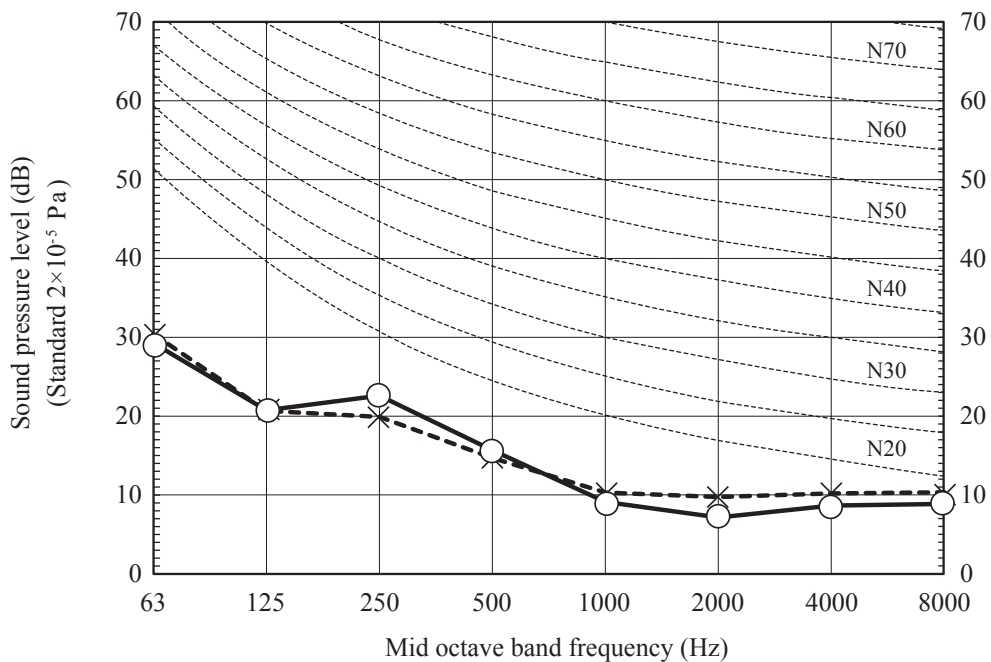

Model SRK35ZS-W, -WB, -WT

Condition	ISO15042 T1/H1
-----------	----------------

MODE	Me
------	----

(Indoor unit)

Model	SRK35ZS-W, WB, WT	
Noise	Cooling	30 dB(A)
Level	Heating	36 dB(A)

●Mike position

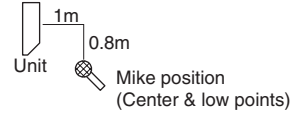

x Cooling, ○ — Heating

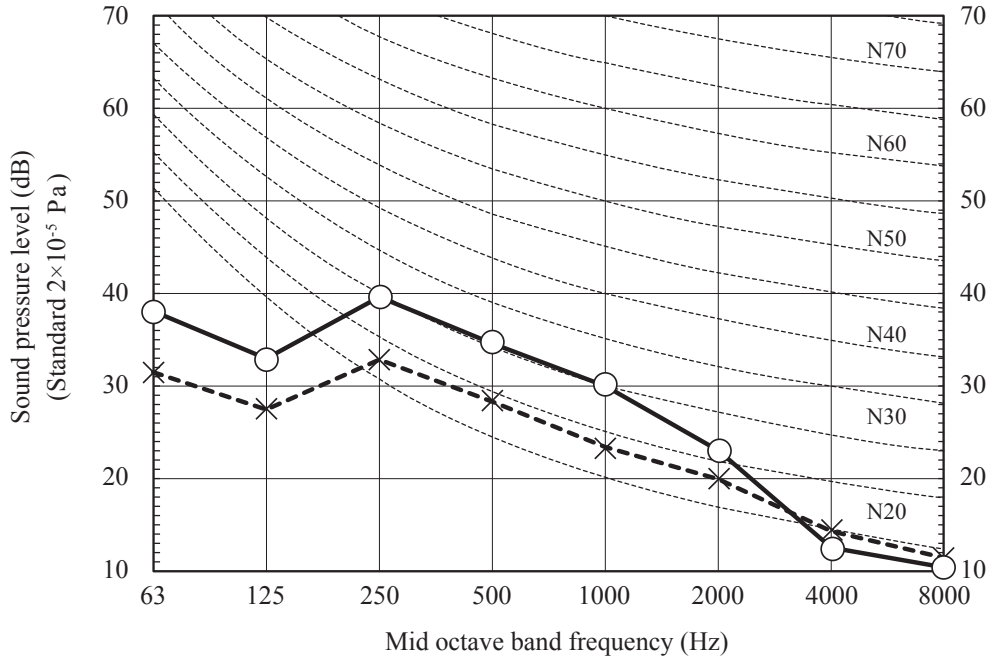

Condition	ISO15042 T1/H1
-----------	----------------

MODE	Lo
------	----

(Indoor unit)

Model	SRK35ZS-W, WB, WT	
Noise	Cooling	26 dB(A)
Level	Heating	25 dB(A)

●Mike position



x Cooling, ○ — Heating

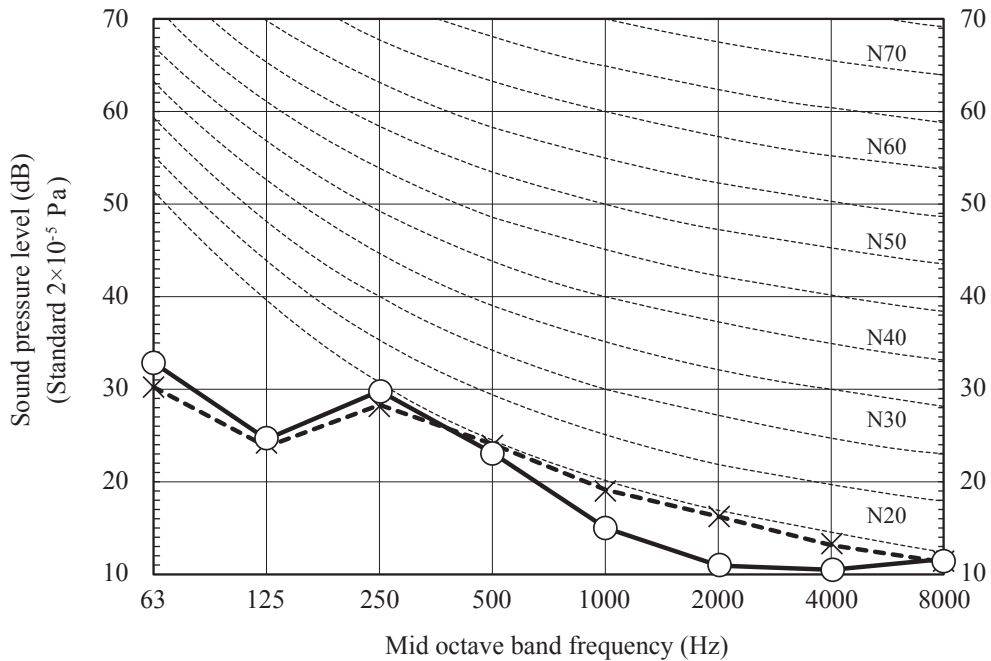

(Indoor unit)

Model	SRK35ZS-W, WB, WT	
Noise Level	Cooling	19 dB(A)
	Heating	19 dB(A)

Condition	ISO15042 T1/H1
-----------	----------------

MODE	ULo
------	-----

●Mike position



x Cooling, ○ — Heating

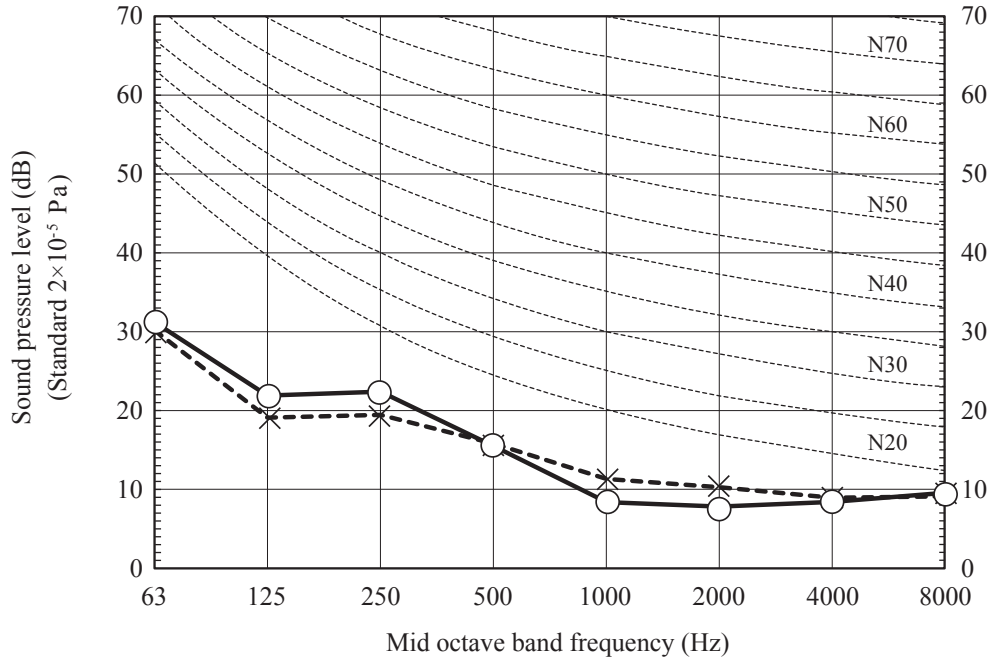

Model SRK50ZS-W, -WB, -WT

(Indoor unit)

Model	SRK50ZS-W, WB, WT	
Noise Level	Cooling	36 dB(A)
	Heating	37 dB(A)

Condition	ISO15042 T1/H1
-----------	----------------

MODE	Me
------	----

●Mike position



x Cooling, ○ — Heating

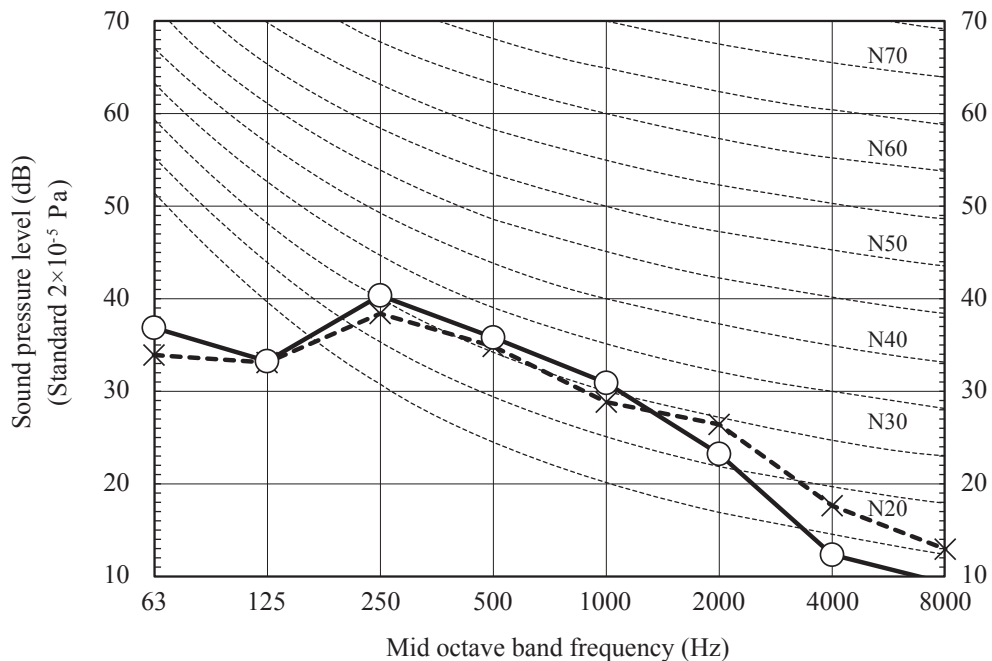

(Indoor unit)

Model	SRK50ZS-W, WB, WT	
Noise Level	Cooling	29 dB(A)
	Heating	31 dB(A)

Condition	ISO15042 T1/H1
-----------	----------------

MODE	Lo
------	----

●Mike position



x Cooling, ○ — Heating

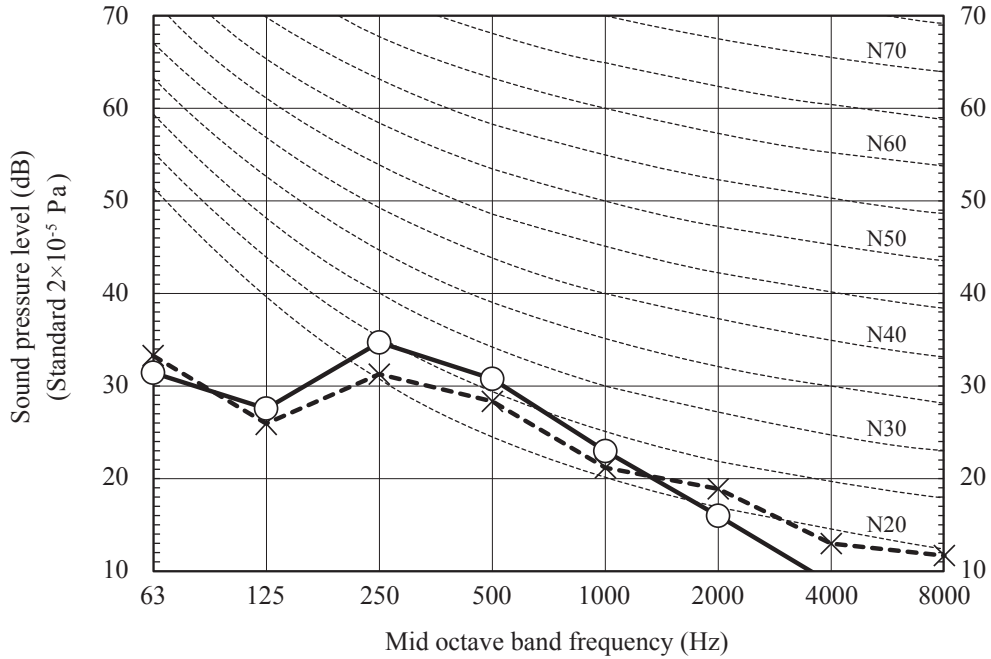

(Indoor unit)

Model	SRK50ZS-W, WB, WT	
Noise Level	Cooling	22 dB(A)
	Heating	24 dB(A)

Condition	ISO15042 T1/H1
-----------	----------------

MODE	ULo
------	-----

●Mike position



x Cooling, ○ — Heating

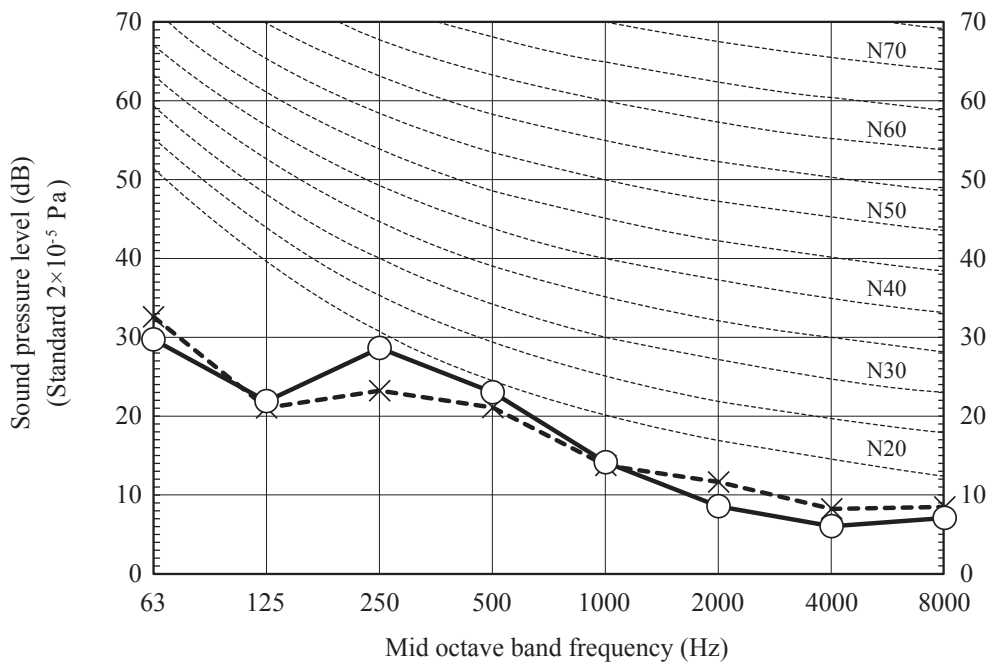

(c) SRK - ZR series
 (i) Sound power level
 Model SRK71ZR-W

(Indoor unit)

Model	SRK71ZR-W	
Noise Level	Cooling	57 dB(A)
	Heating	60 dB(A)

Condition	ISO15042 T1/H1
MODE	Rated capacity value (Hi)

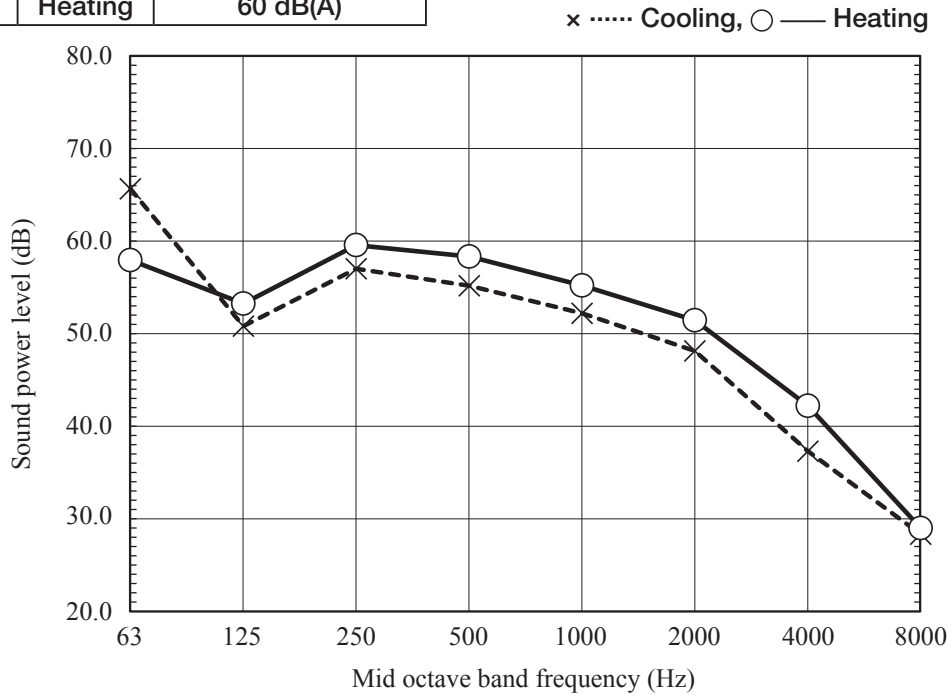

Model SRK80ZR-W

(Indoor unit)

Model	SRK80ZR-W	
Noise Level	Cooling	60 dB(A)
	Heating	62 dB(A)

Condition	ISO15042 T1/H1
MODE	Rated capacity value (Hi)

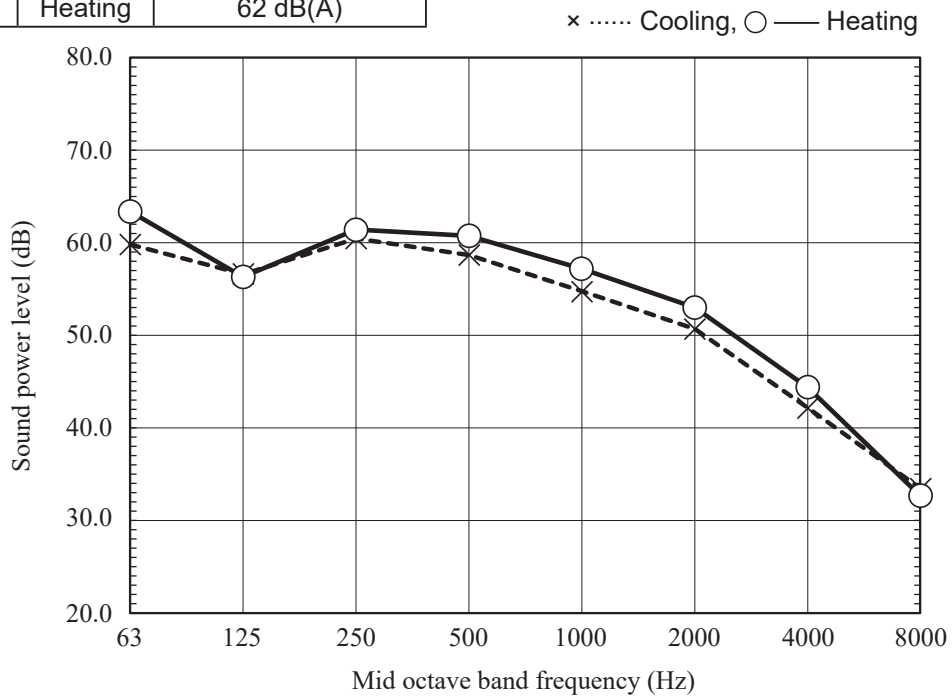

(ii) Sound power level
 1) Rated capacity value
 Model SRK71ZR-W

(Indoor unit)

Model	SRK71ZR-W	
Noise Level	Cooling	44 dB(A)
	Heating	46 dB(A)

Condition	ISO15042 T1/H1
-----------	----------------

MODE	Rated capacity value (Hi)
------	---------------------------

●Mike position



x Cooling, ○ — Heating

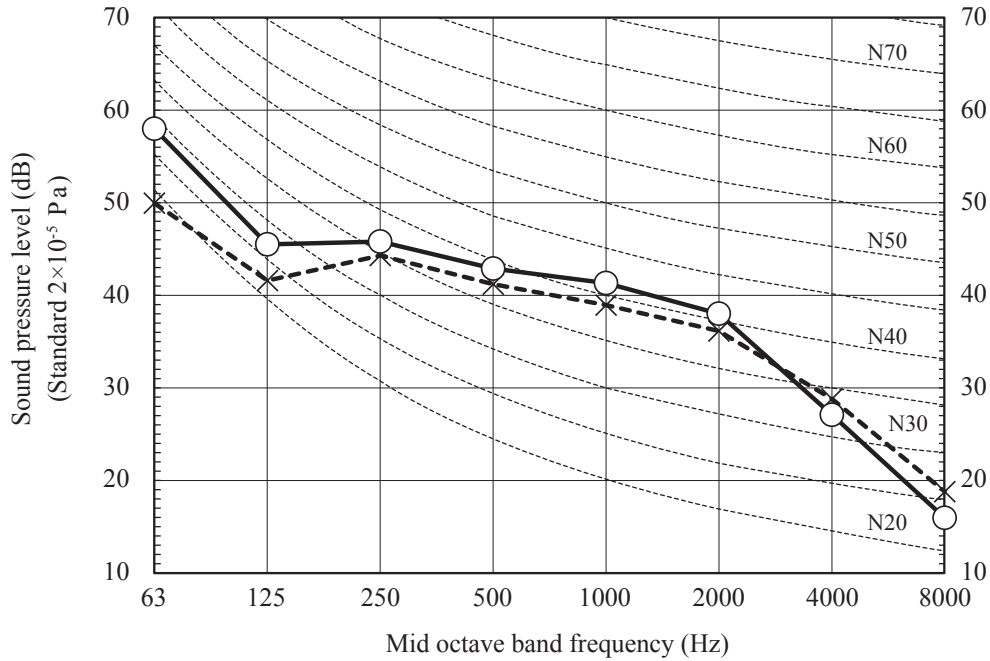

Model SRK80ZR-W

(Indoor unit)

Model	SRK80ZR-W	
Noise Level	Cooling	47 dB(A)
	Heating	47 dB(A)

Condition	ISO15042 T1/H1
-----------	----------------

MODE	Rated capacity value (Hi)
------	---------------------------

●Mike position



x Cooling, ○ — Heating

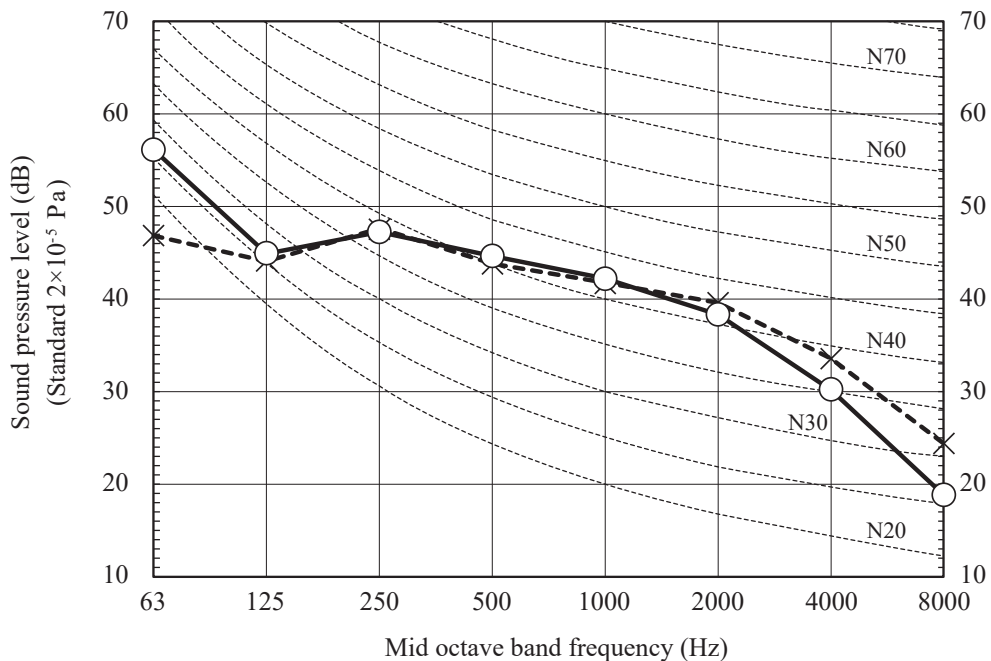

2) Each fan speed mode
Model SRK71ZR-W

(Indoor unit)

Model	SRK71ZR-W	
Noise	Cooling	41 dB(A)
Level	Heating	39 dB(A)

Condition	ISO15042 T1/H1
-----------	----------------

MODE	Me
------	----

●Mike position



x Cooling, ○ — Heating

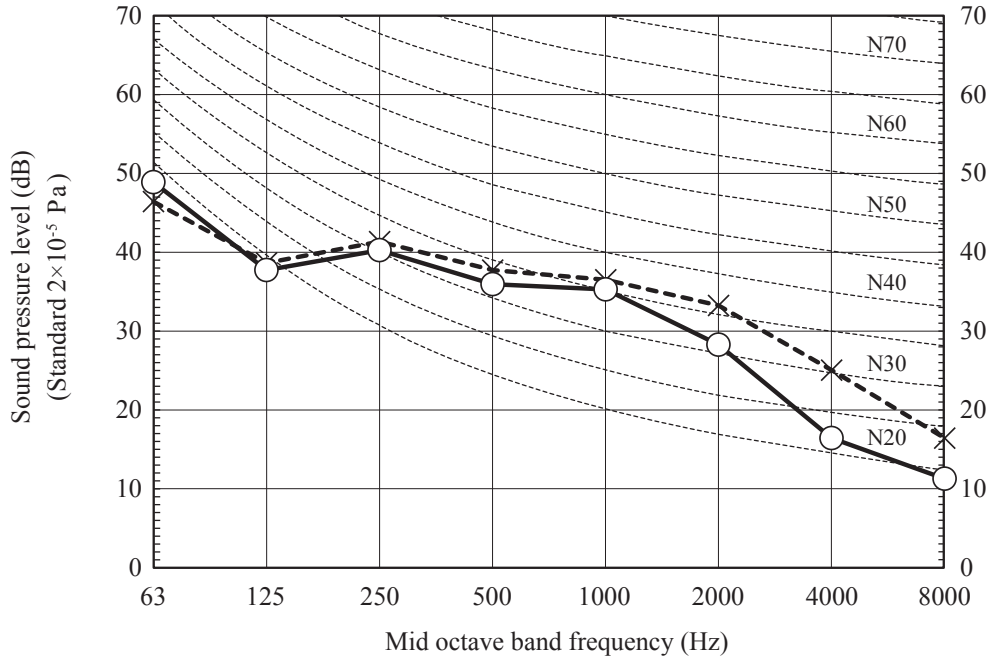

(Indoor unit)

Model	SRK71ZR-W	
Noise	Cooling	37 dB(A)
Level	Heating	35 dB(A)

Condition	ISO15042 T1/H1
-----------	----------------

MODE	Lo
------	----

●Mike position



x Cooling, ○ — Heating

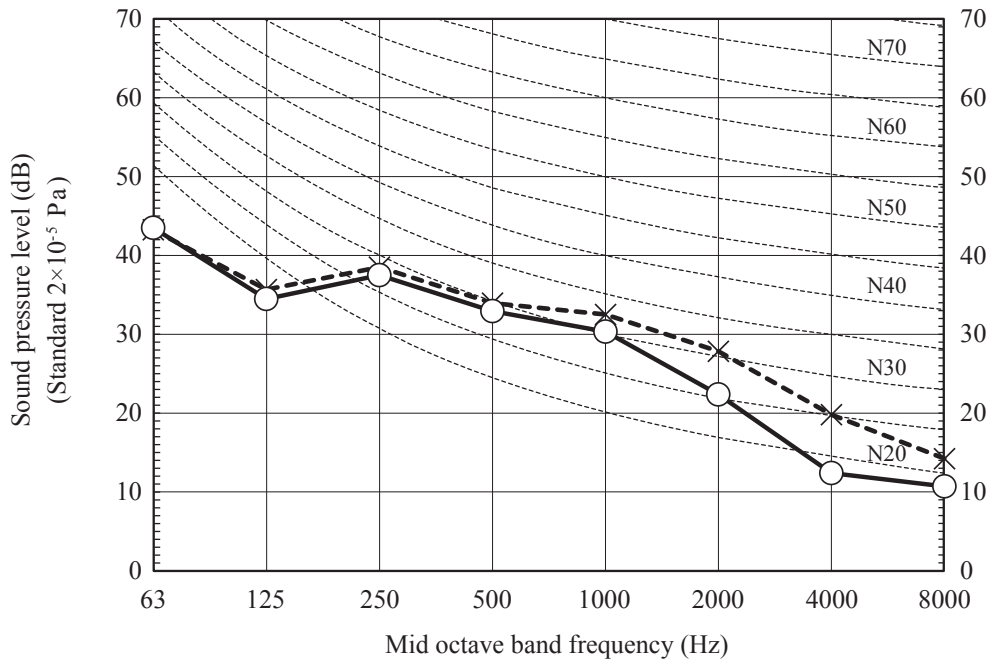

(Indoor unit)

Model	SRK71ZR-W	
Noise	Cooling	25 dB(A)
Level	Heating	28 dB(A)

Condition	ISO15042 T1/H1
-----------	----------------

MODE	ULo
------	-----

●Mike position



x Cooling, ○ — Heating

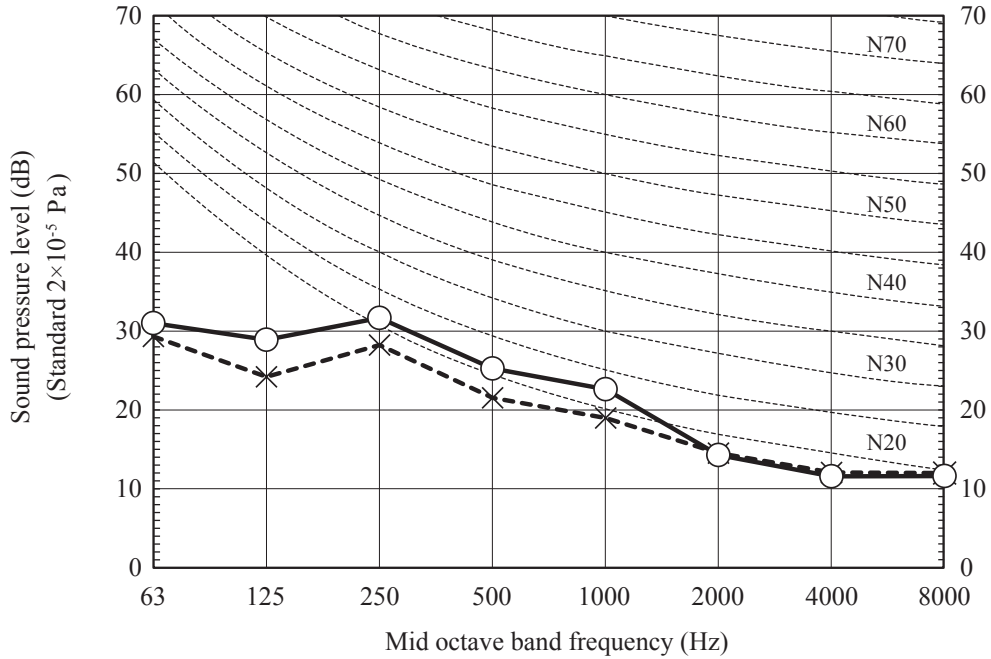

Model SRK80ZR-W

(Indoor unit)

Model	SRK80ZR-W	
Noise	Cooling	44 dB(A)
Level	Heating	41 dB(A)

Condition	ISO15042 T1/H1
-----------	----------------

MODE	Me
------	----

●Mike position



x Cooling, ○ — Heating

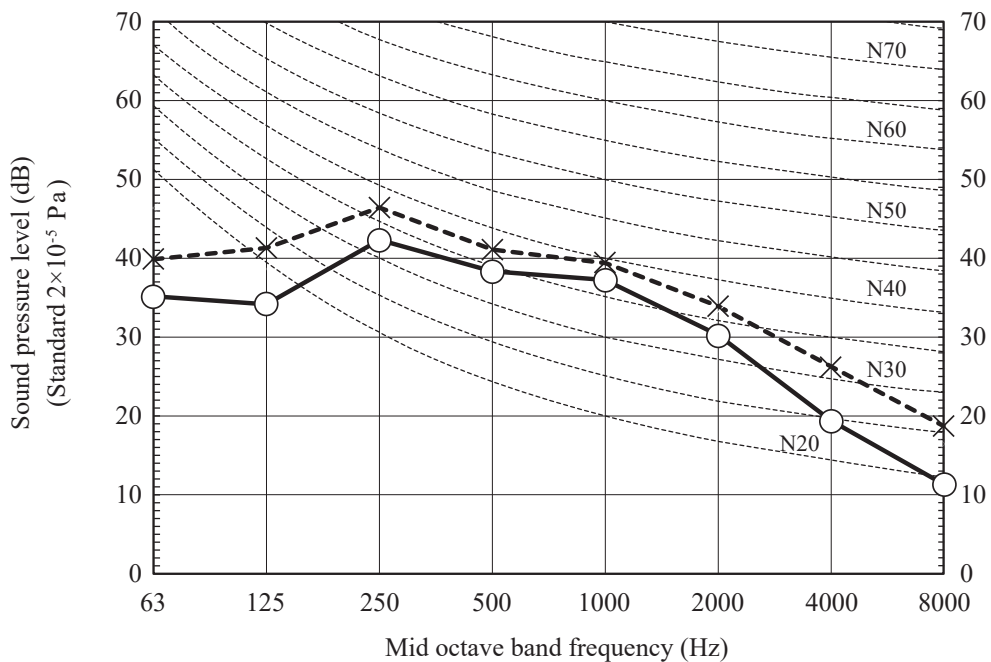

(Indoor unit)

Model	SRK80ZR-W	
Noise	Cooling	39 dB(A)
Level	Heating	36 dB(A)

Condition	ISO15042 T1/H1
-----------	----------------

MODE	Lo
------	----

●Mike position



× Cooling, ○ — Heating

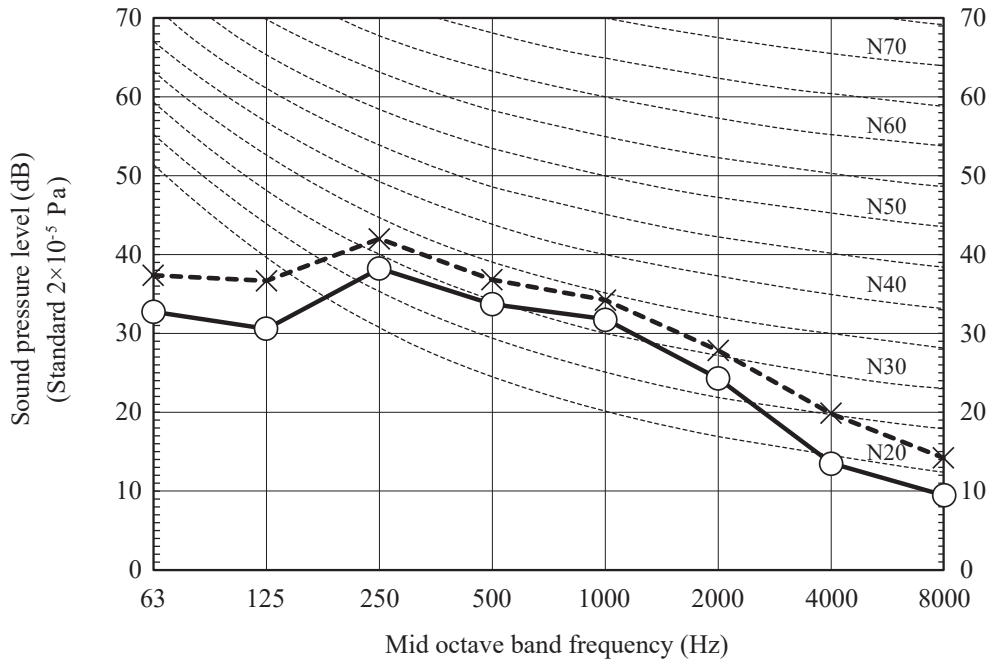

(Indoor unit)

Model	SRK80ZR-W	
Noise	Cooling	26 dB(A)
Level	Heating	29 dB(A)

Condition	ISO15042 T1/H1
-----------	----------------

MODE	ULo
------	-----

●Mike position



× Cooling, ○ — Heating

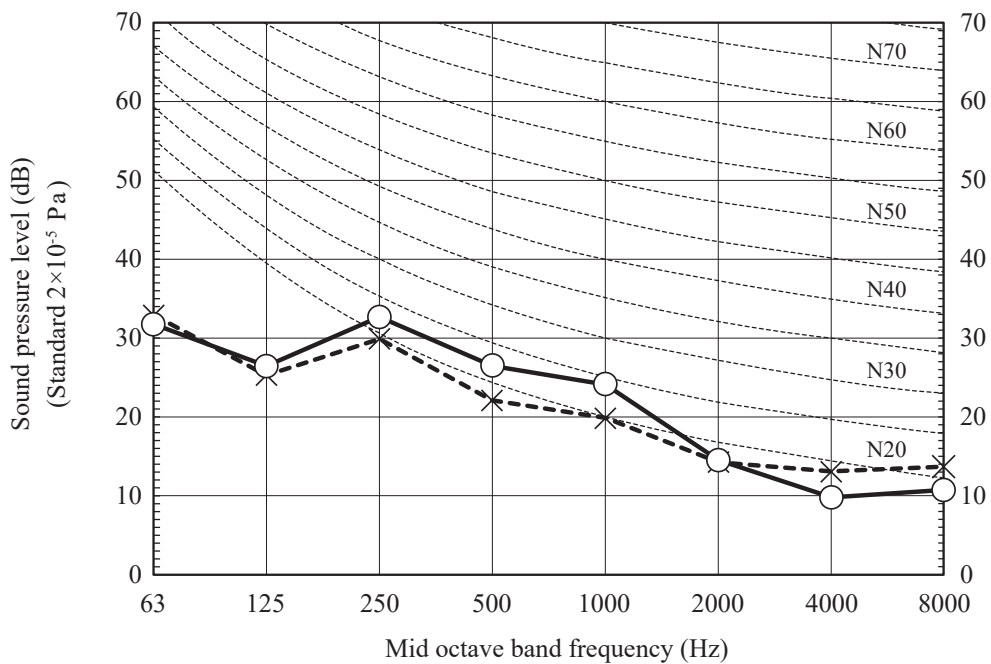

(d) SKM - ZSP series

(i) Sound power level

Model SKM20ZSP-W

(Indoor unit)

Model	SKM20ZSP-W	
Noise Level	Cooling	57 dB(A)
	Heating	56 dB(A)

Condition	ISO15042 T1/H1
-----------	----------------

MODE	Rated capacity value (Hi)
------	---------------------------

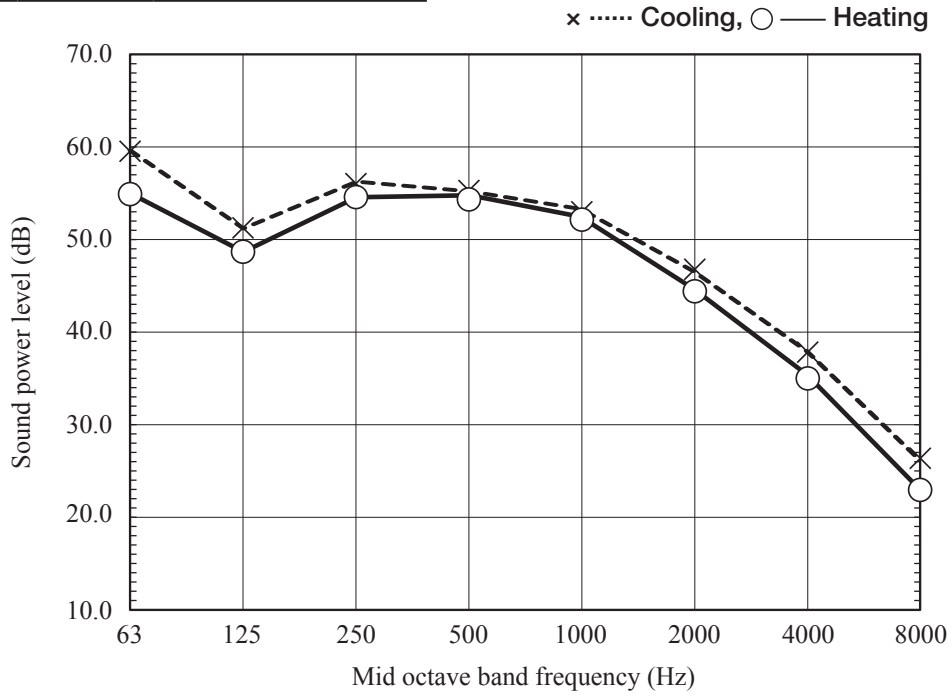

Model SKM25ZSP-W

(Indoor unit)

Model	SKM25ZSP-W	
Noise Level	Cooling	57 dB(A)
	Heating	56 dB(A)

Condition	ISO15042 T1/H1
-----------	----------------

MODE	Rated capacity value (Hi)
------	---------------------------

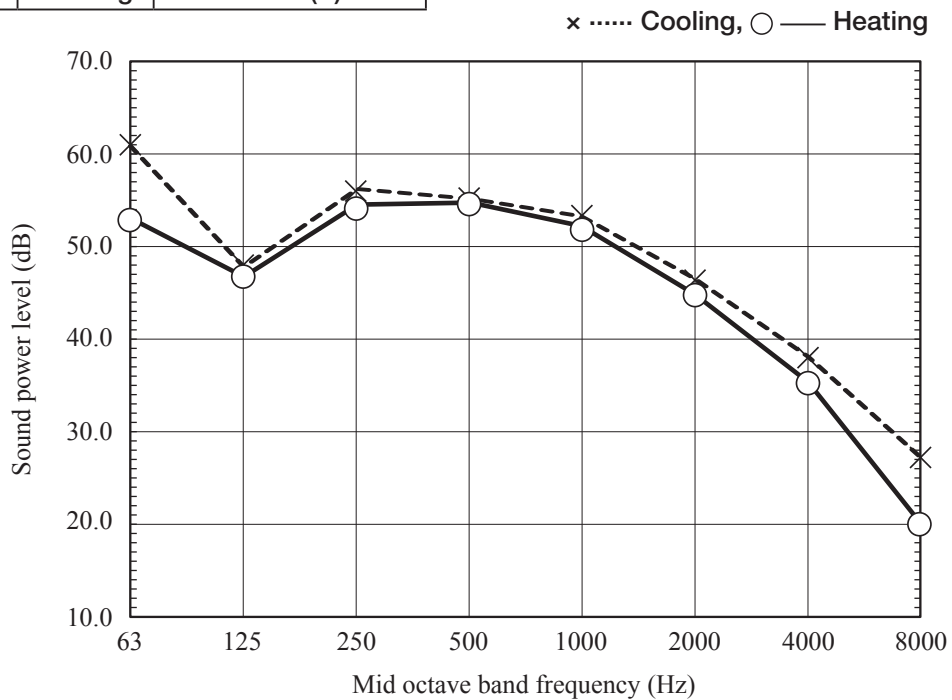

Model SKM35ZSP-W

(Indoor unit)

Model	SKM35ZSP-W	
Noise Level	Cooling	58 dB(A)
	Heating	58 dB(A)

Condition	ISO15042 T1/H1
MODE	Rated capacity value (Hi)

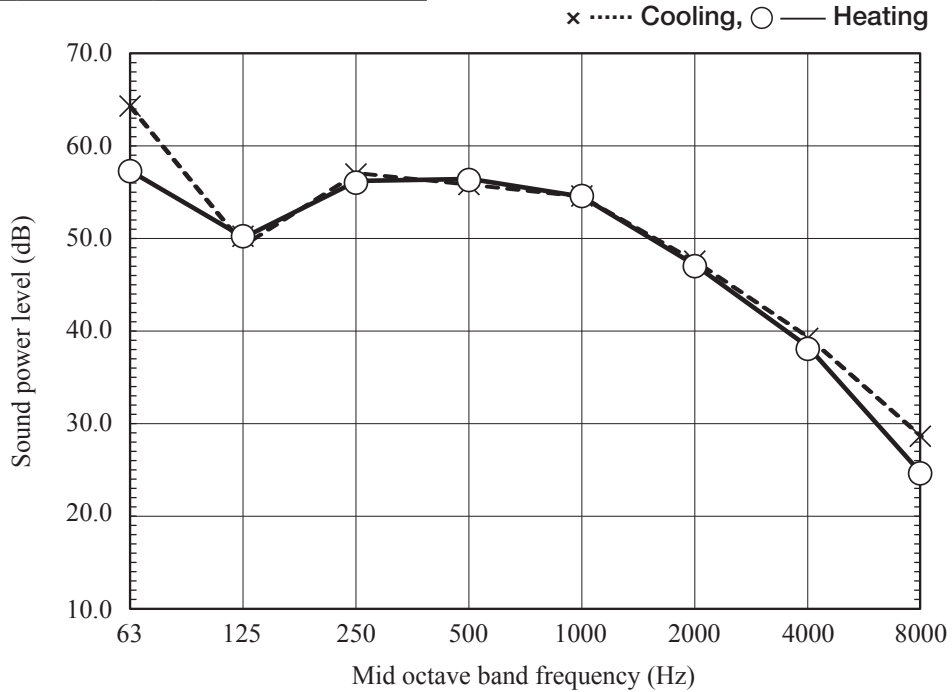

(ii) Sound pressure level

1) Rated capacity value
Model SKM20ZSP-W

(Indoor unit)

Model	SKM20ZSP-W	
Noise Level	Cooling	42 dB(A)
	Heating	41 dB(A)

Condition	ISO15042 T1/H1
MODE	Rated capacity value (Hi)

● Mike position

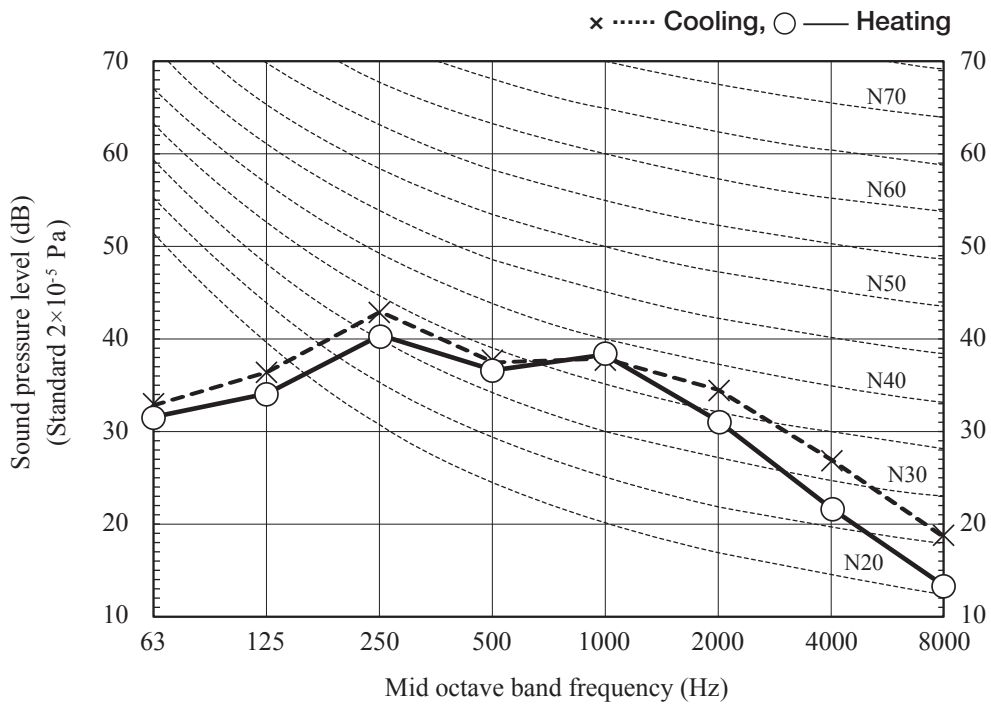

Model SKM25ZSP-W

(Indoor unit)

Model	SKM25ZSP-W	
Noise Level	Cooling	43 dB(A)
	Heating	41 dB(A)

Condition	ISO15042 T1/H1
-----------	----------------

MODE	Rated capacity value (Hi)
------	---------------------------

●Mike position



x Cooling, ○ — Heating

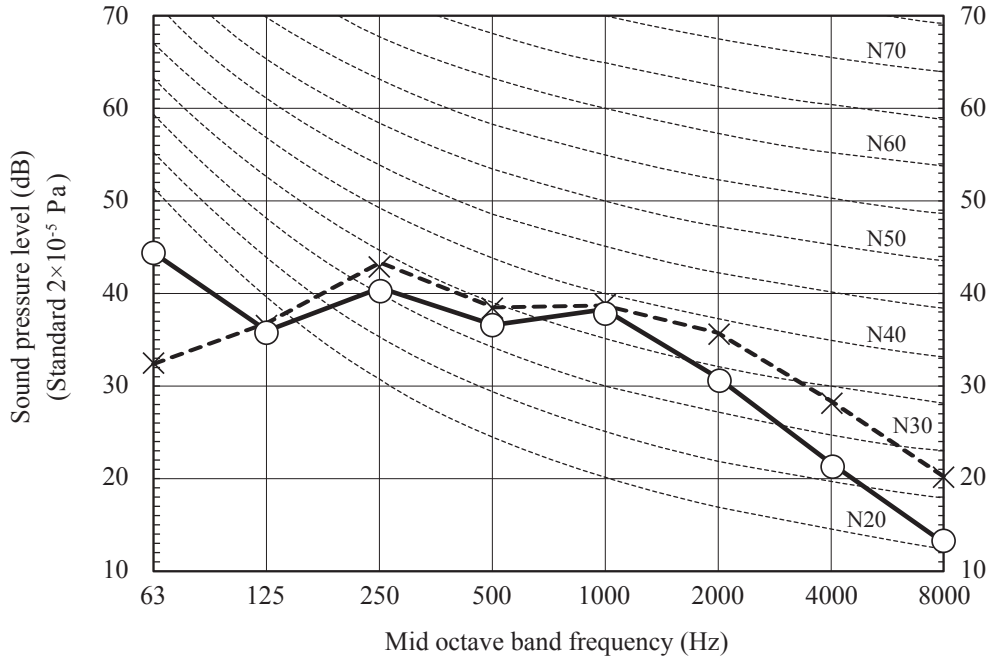

Model SKM35ZSP-W

(Indoor unit)

Model	SKM35ZSP-W	
Noise Level	Cooling	44 dB(A)
	Heating	42 dB(A)

Condition	ISO15042 T1/H1
-----------	----------------

MODE	Rated capacity value (Hi)
------	---------------------------

●Mike position



x Cooling, ○ — Heating

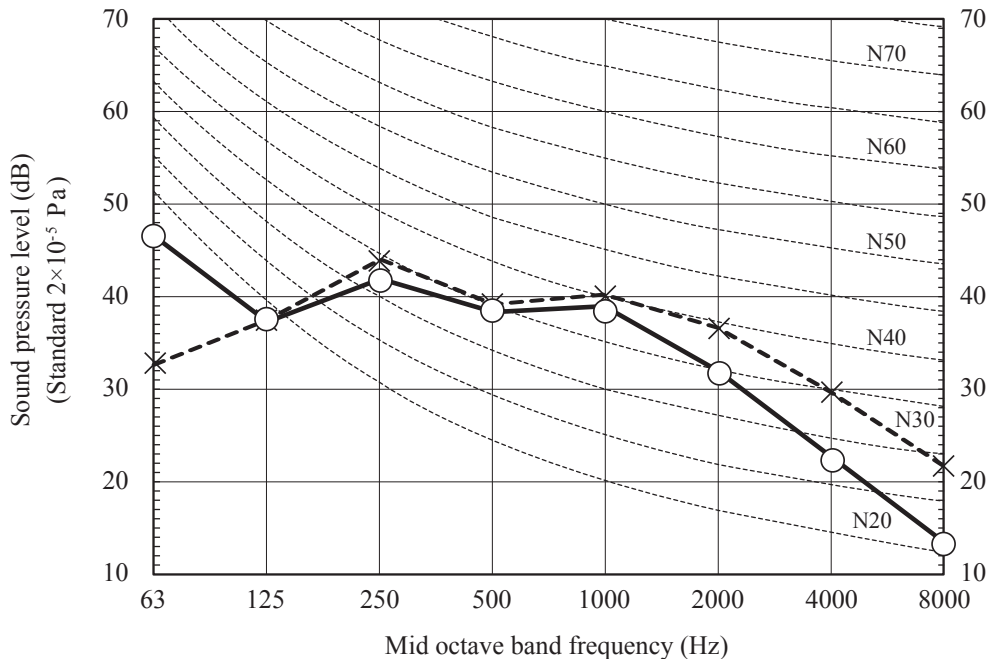

2) Each fan speed mode
Model SKM20ZSP-W

(Indoor unit)

Model	SKM20ZSP-W	
Noise Level	Cooling	35 dB(A)
	Heating	36 dB(A)

Condition	ISO15042 T1/H1
-----------	----------------

MODE	Me
------	----

●Mike position

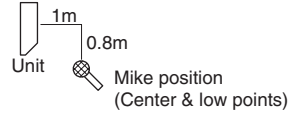

x Cooling, ○ — Heating

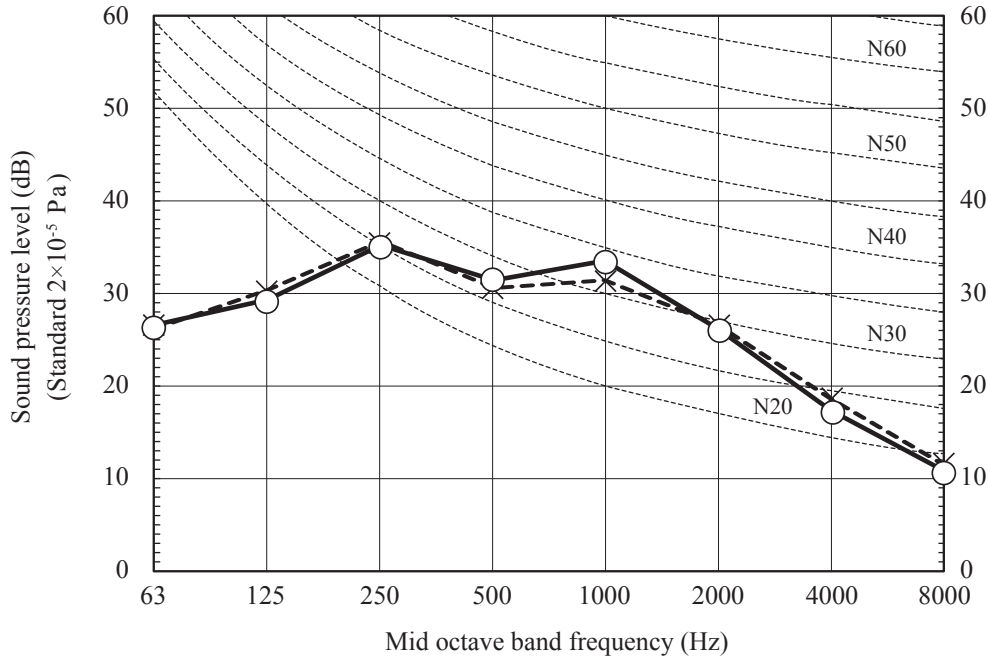

(Indoor unit)

Model	SKM20ZSP-W	
Noise Level	Cooling	22 dB(A)
	Heating	26 dB(A)

Condition	ISO15042 T1/H1
-----------	----------------

MODE	Lo
------	----

●Mike position



x Cooling, ○ — Heating

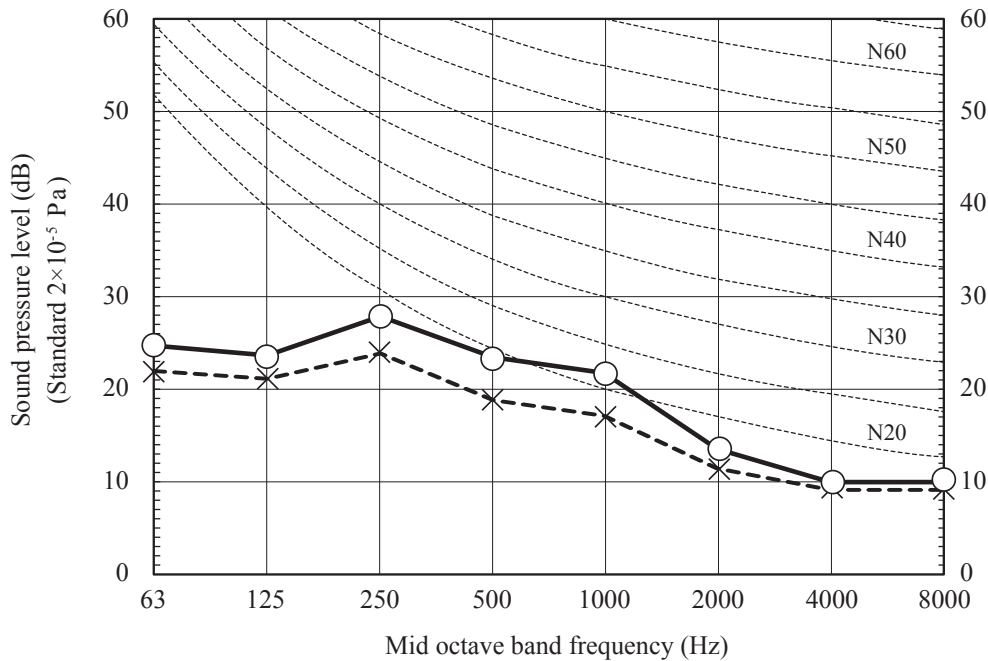

Model SKM25ZSP-W

(Indoor unit)

Model	SKM25ZSP-W	
Noise Level	Cooling	36 dB(A)
	Heating	36 dB(A)

Condition	ISO15042 T1/H1
-----------	----------------

MODE	Me
------	----

●Mike position

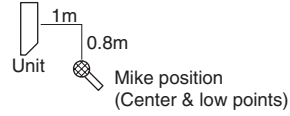

x Cooling, ○ — Heating

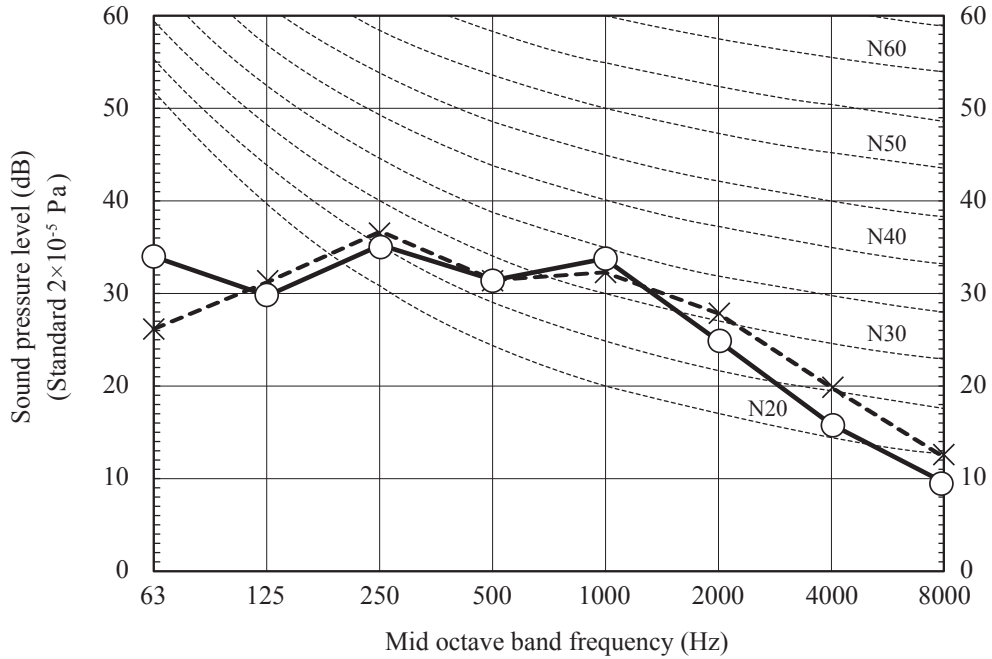

Condition	ISO15042 T1/H1
-----------	----------------

MODE	Lo
------	----

●Mike position



x Cooling, ○ — Heating

(Indoor unit)

Model	SKM25ZSP-W	
Noise Level	Cooling	23 dB(A)
	Heating	27 dB(A)

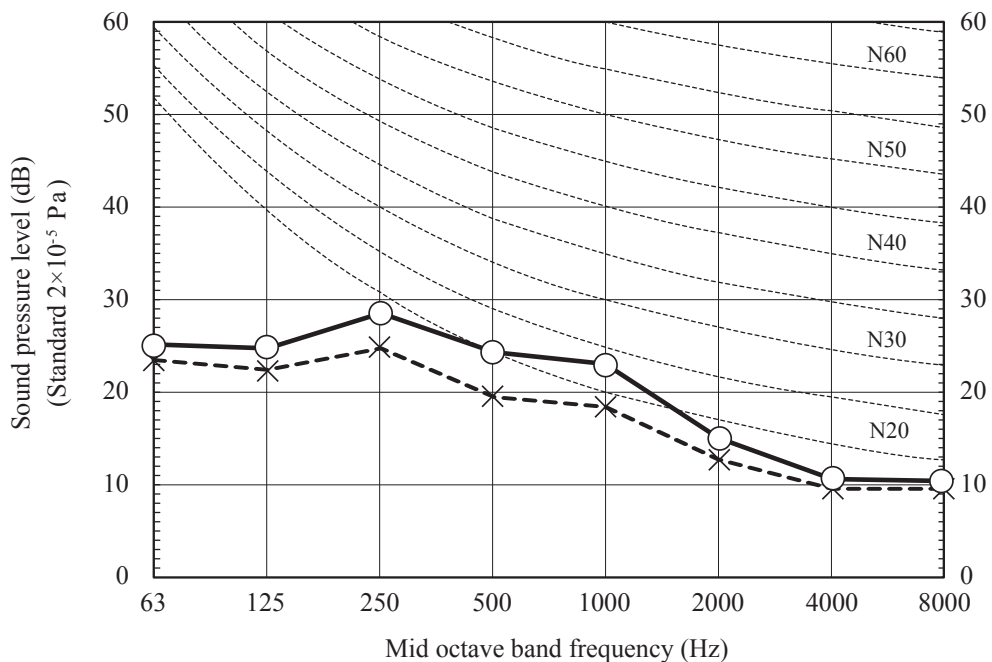

Model SKM35ZSP-W

(Indoor unit)

Model	SKM35ZSP-W	
Noise Level	Cooling	37 dB(A)
	Heating	37 dB(A)

Condition	ISO15042 T1/H1
-----------	----------------

MODE	Me
------	----

●Mike position



x Cooling, ○ — Heating

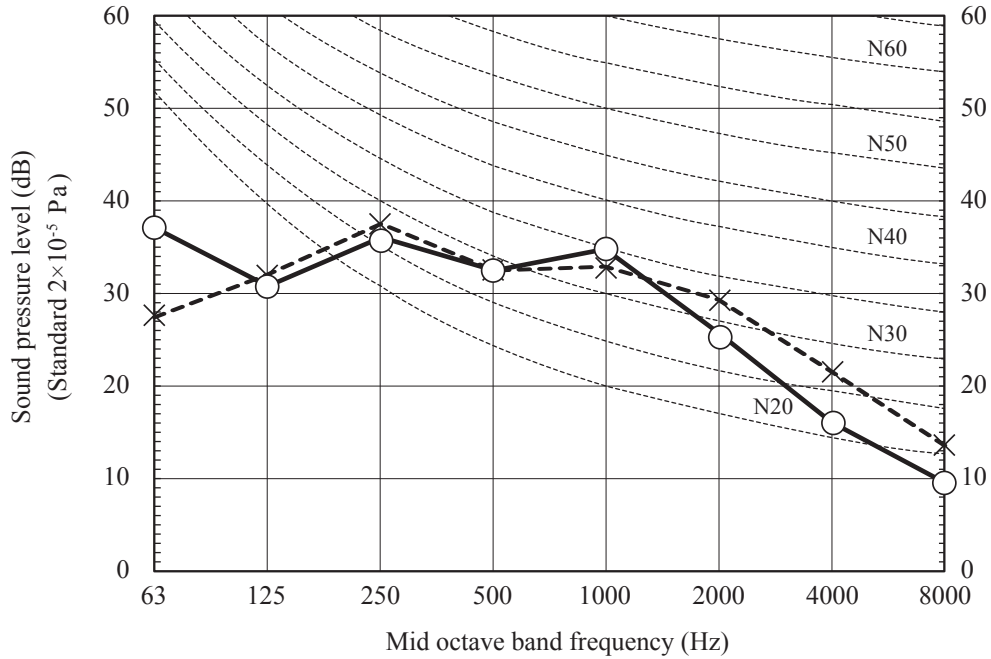

Condition	ISO15042 T1/H1
-----------	----------------

MODE	Lo
------	----

●Mike position



x Cooling, ○ — Heating

(Indoor unit)

Model	SKM35ZSP-W	
Noise Level	Cooling	25 dB(A)
	Heating	30 dB(A)

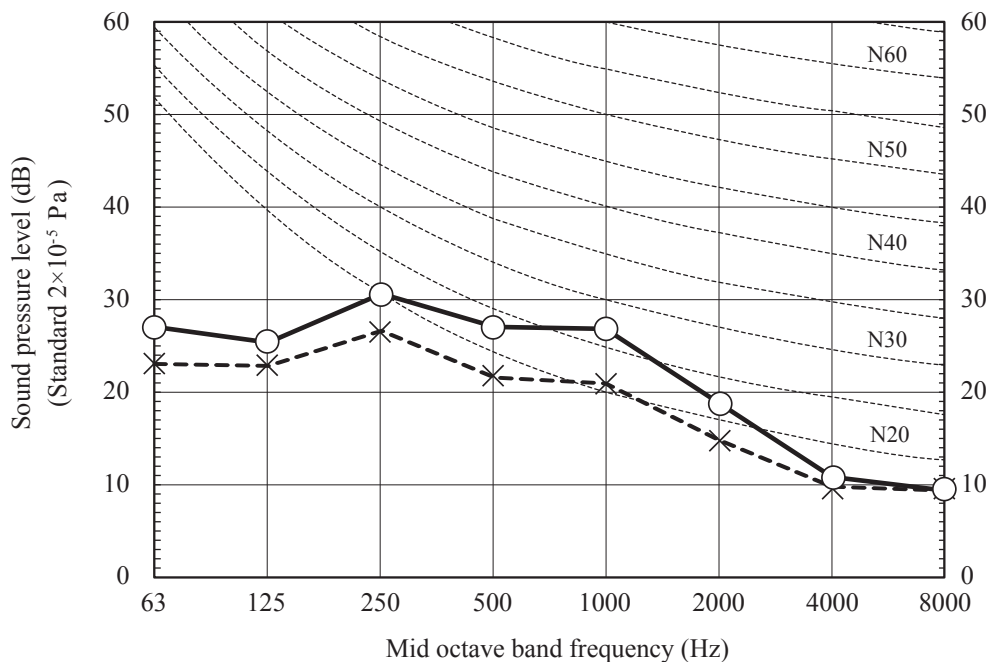

(2) Floor standing type (SRF)

(a) Sound power level

Model SRK25ZS-W

(Indoor unit)

Model	SRF25ZS-W	
Noise Level	Cooling	50 dB(A)
	Heating	51 dB(A)

Condition	ISO15042 T1/H1
-----------	----------------

MODE	Rated capacity value (Hi)
------	---------------------------

× Cooling ○ — Heating

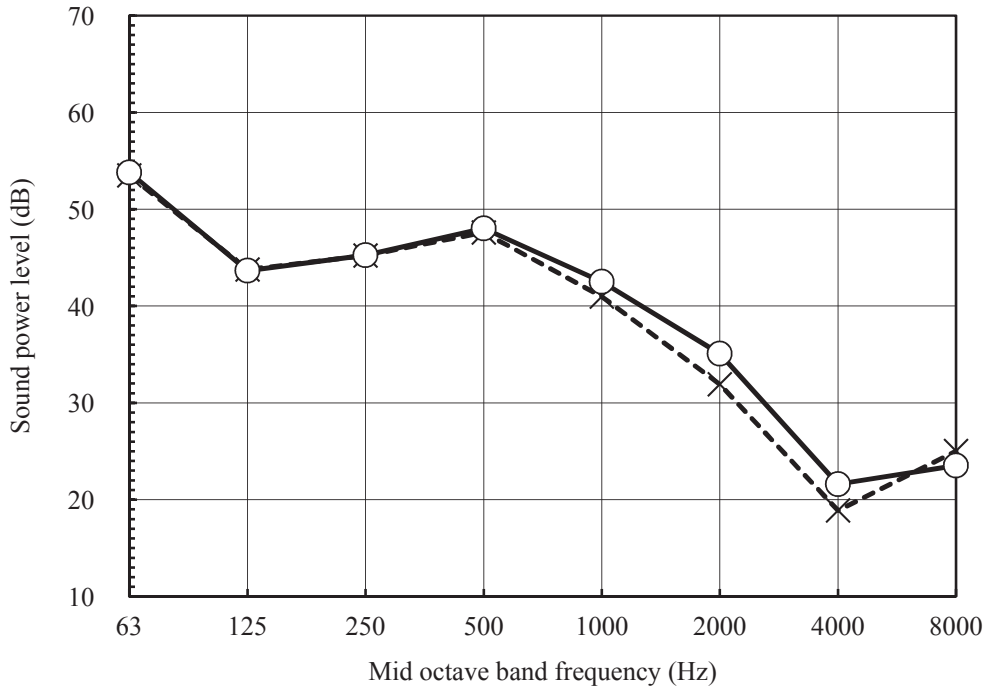

Model SRF35ZS-W

(Indoor unit)

Model	SRF35ZS-W	
Noise Level	Cooling	51 dB(A)
	Heating	52 dB(A)

Condition	ISO15042 T1/H1
-----------	----------------

MODE	Rated capacity value (Hi)
------	---------------------------

× Cooling ○ — Heating

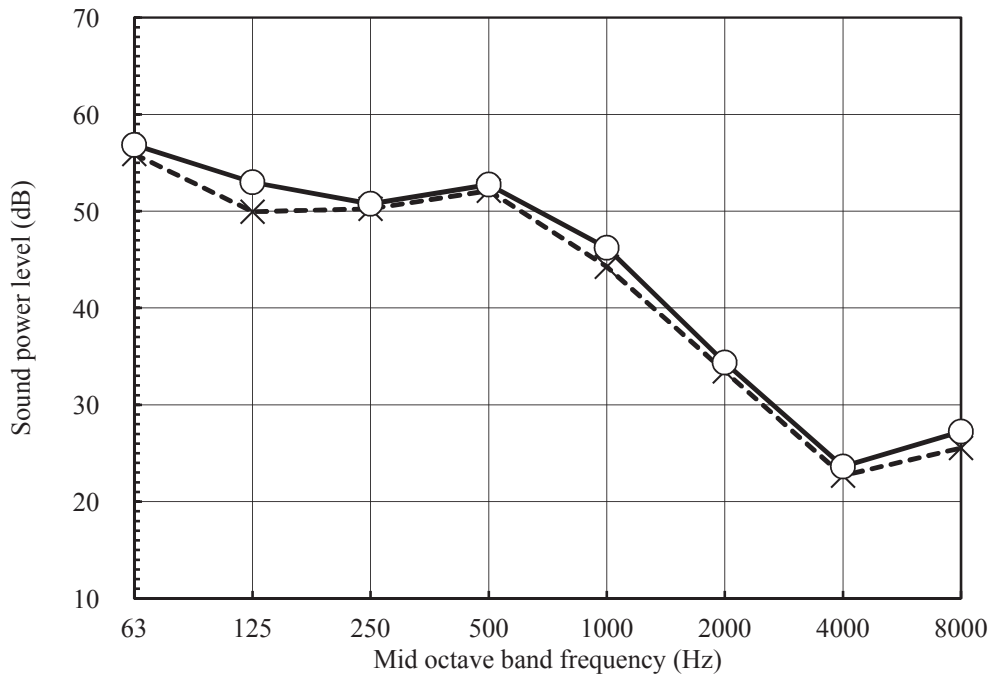

Model SRF50ZSX-W

(Indoor unit)

Model	SRF50ZSX-W	
Noise Level	Cooling	58 dB(A)
	Heating	58 dB(A)

Condition	ISO15042 T1/H1
-----------	----------------

MODE	Rated capacity value (Hi)
------	---------------------------

× Cooling ○ — Heating

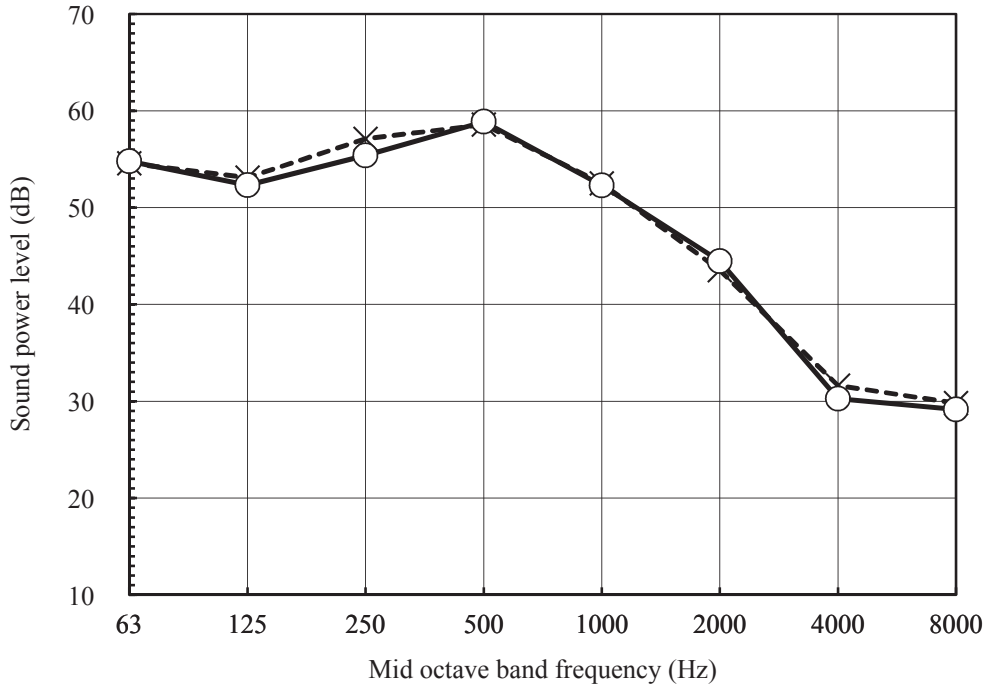

(b) Sound pressure level

(i) Rated capacity value (Hi)

Model SRF25ZS-W

(Indoor unit)

Model	SRF25ZS-W	
Noise Level	Cooling	38 dB(A)
	Heating	39 dB(A)

Condition	ISO15042 T1/H1
-----------	----------------

MODE	Rated capacity value (Hi)
------	---------------------------

● Mike position

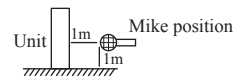

× Cooling, ○ — Heating

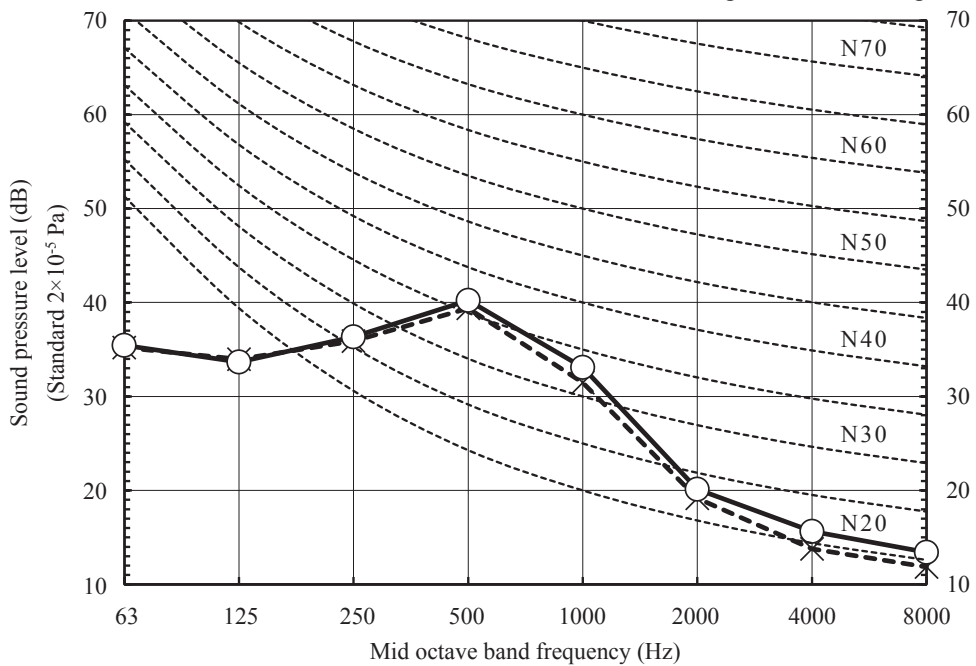

Model SRF35ZS-W

Condition	ISO15042 T1/H1
-----------	----------------

MODE	Rated capacity value (Hi)
------	---------------------------

(Indoor unit)

Model	SRF35ZS-W	
Noise Level	Cooling	40 dB(A)
	Heating	41 dB(A)

●Mike position

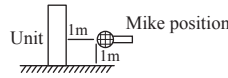

× Cooling, ○ — Heating

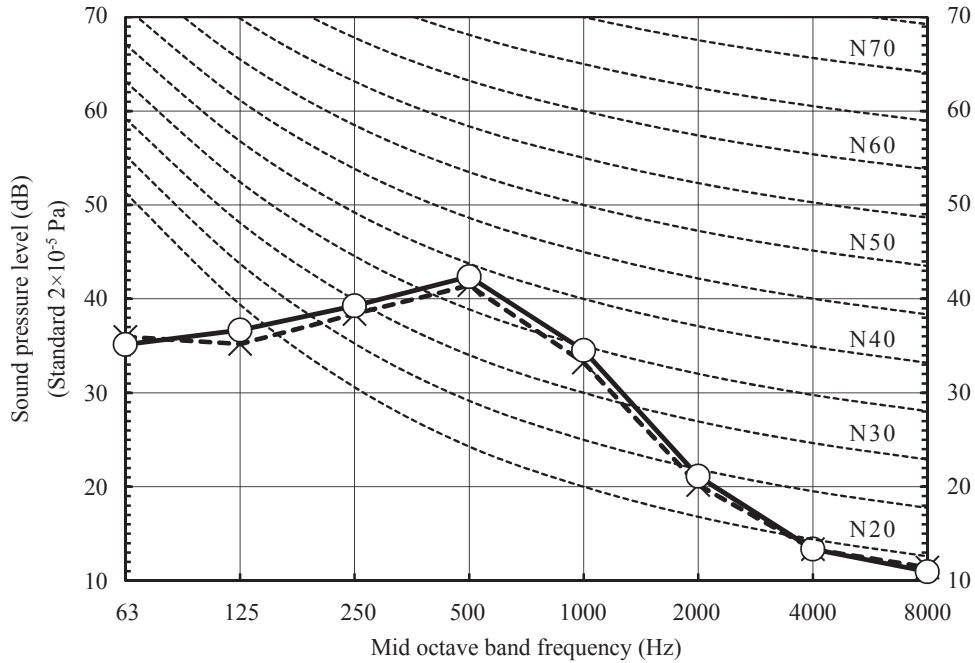

Model SRF50ZSX-W

Condition	ISO15042 T1/H1
-----------	----------------

MODE	Rated capacity value (Hi)
------	---------------------------

(Indoor unit)

Model	SRF50ZSX-W	
Noise Level	Cooling	46 dB(A)
	Heating	46 dB(A)

●Mike position

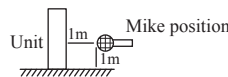

× Cooling, ○ — Heating

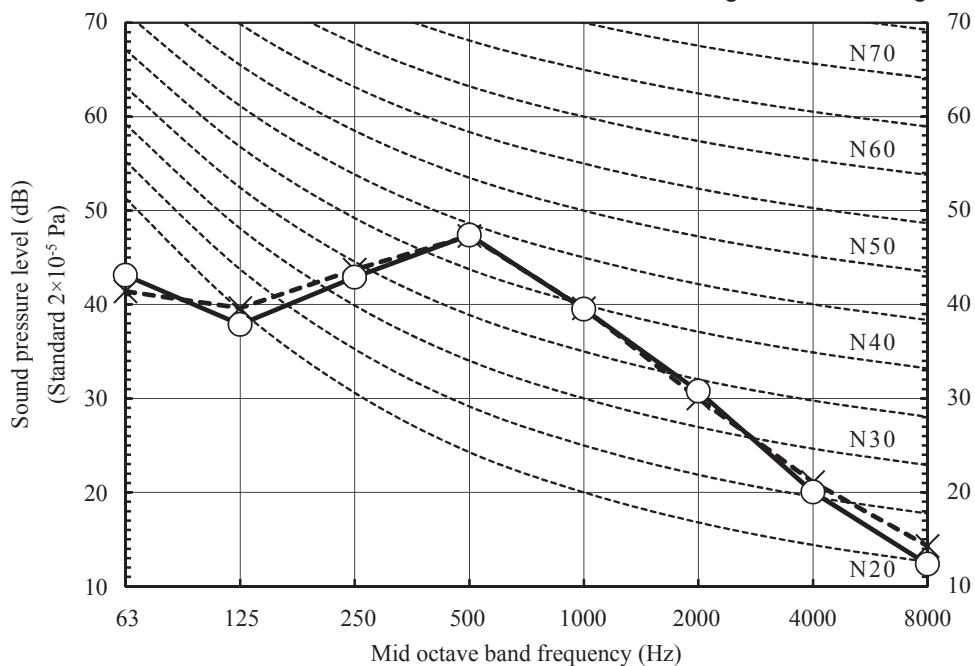

(ii) Each fan speed mode
Model SRF25ZS-W

(Indoor unit)

Model	SRF25ZS-W	
Noise	Cooling	32 dB(A)
Level	Heating	35 dB(A)

Condition	ISO15042 T1/H1
-----------	----------------

MODE	Me
------	----

●Mike position

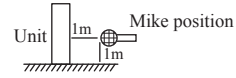

× Cooling, ○ — Heating

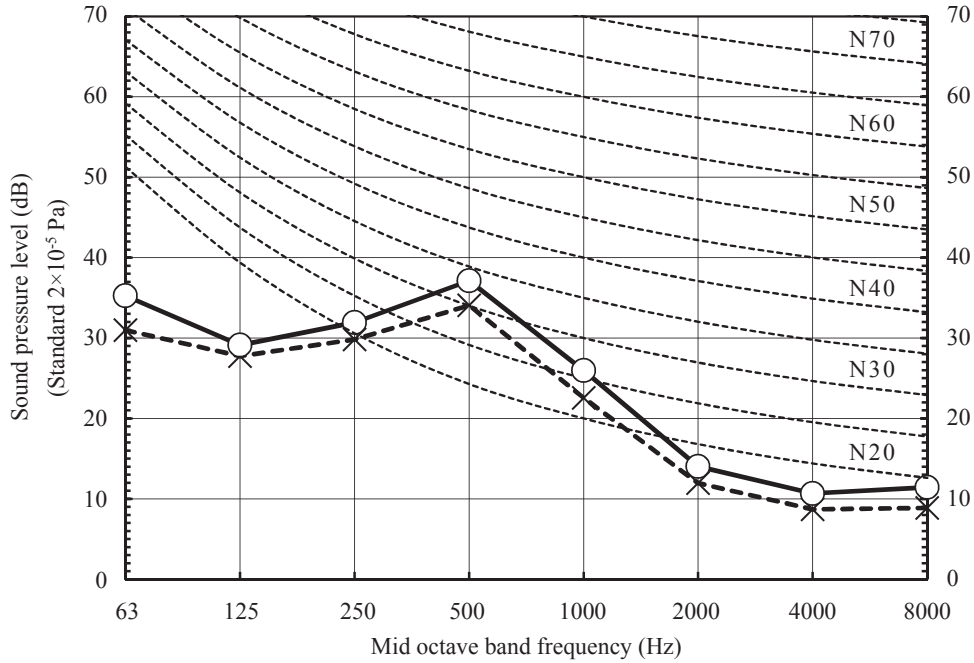

(Indoor unit)

Model	SRF25ZS-W	
Noise	Cooling	29 dB(A)
Level	Heating	33 dB(A)

Condition	ISO15042 T1/H1
-----------	----------------

MODE	Lo
------	----

●Mike position

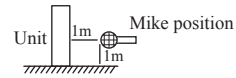

× Cooling, ○ — Heating

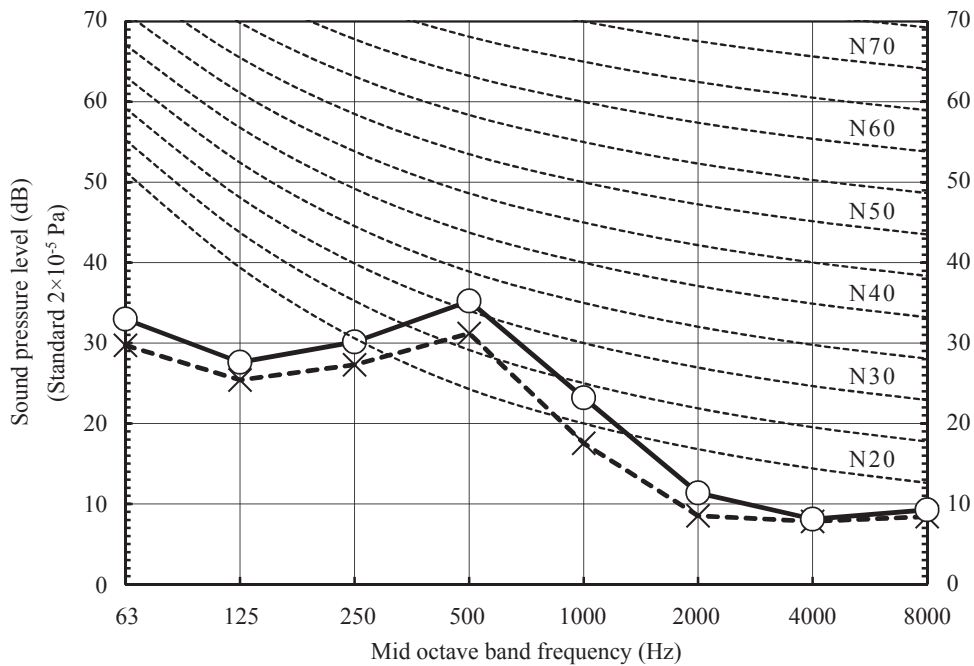

(Indoor unit)

Model	SRF25ZS-W	
Noise Level	Cooling	25 dB(A)
	Heating	29 dB(A)

Condition	ISO15042 T1/H1
-----------	----------------

MODE	ULo
------	-----

●Mike position

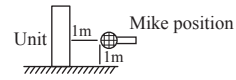

× Cooling, ○ — Heating

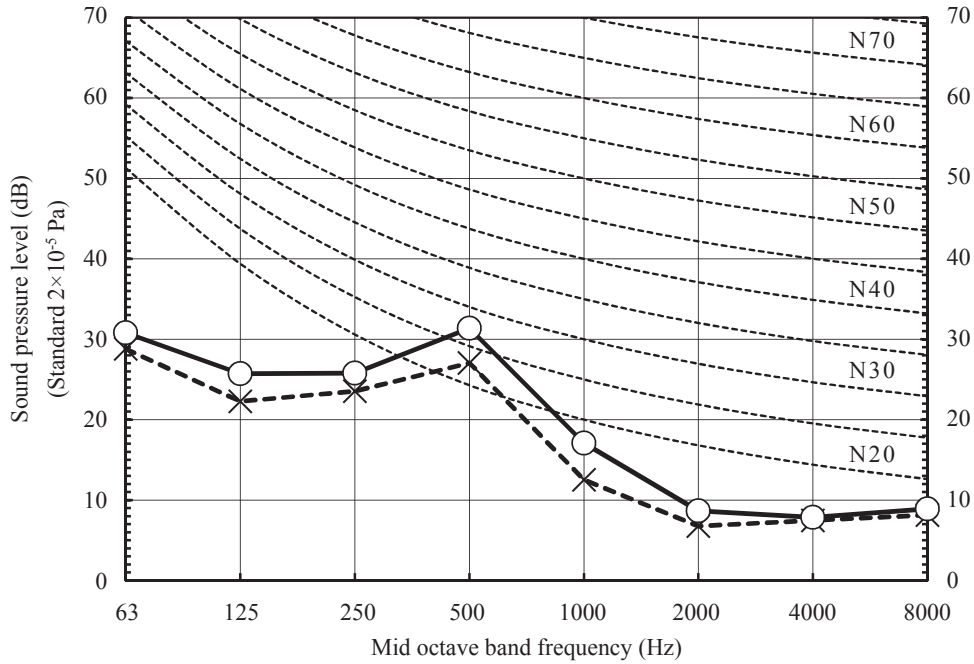

Model SRF35ZS-W

(Indoor unit)

Model	SRF35ZS-W	
Noise Level	Cooling	35 dB(A)
	Heating	36 dB(A)

Condition	ISO15042 T1/H1
-----------	----------------

MODE	Me
------	----

●Mike position

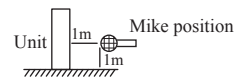

× Cooling, ○ — Heating

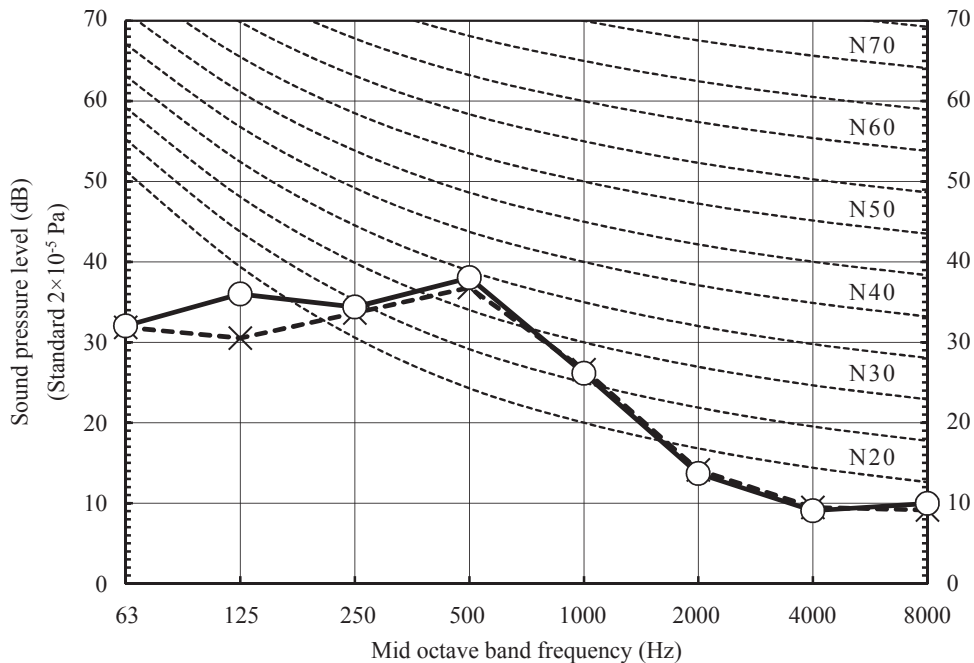

(Indoor unit)

Model	SRF35ZS-W	
Noise Level	Cooling	33 dB(A)
	Heating	35 dB(A)

Condition	ISO15042 T1/H1
MODE	Lo

●Mike position

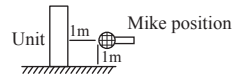

× Cooling, ○ — Heating

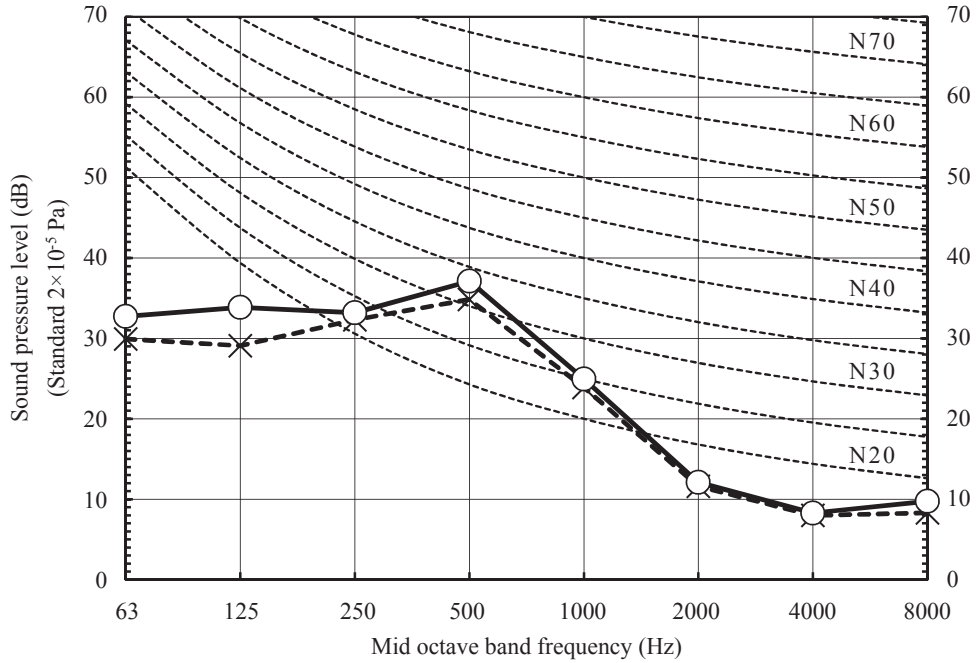

(Indoor unit)

Model	SRF35ZS-W	
Noise Level	Cooling	29 dB(A)
	Heating	33 dB(A)

Condition	ISO15042 T1/H1
MODE	ULo

●Mike position

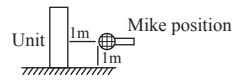

× Cooling, ○ — Heating

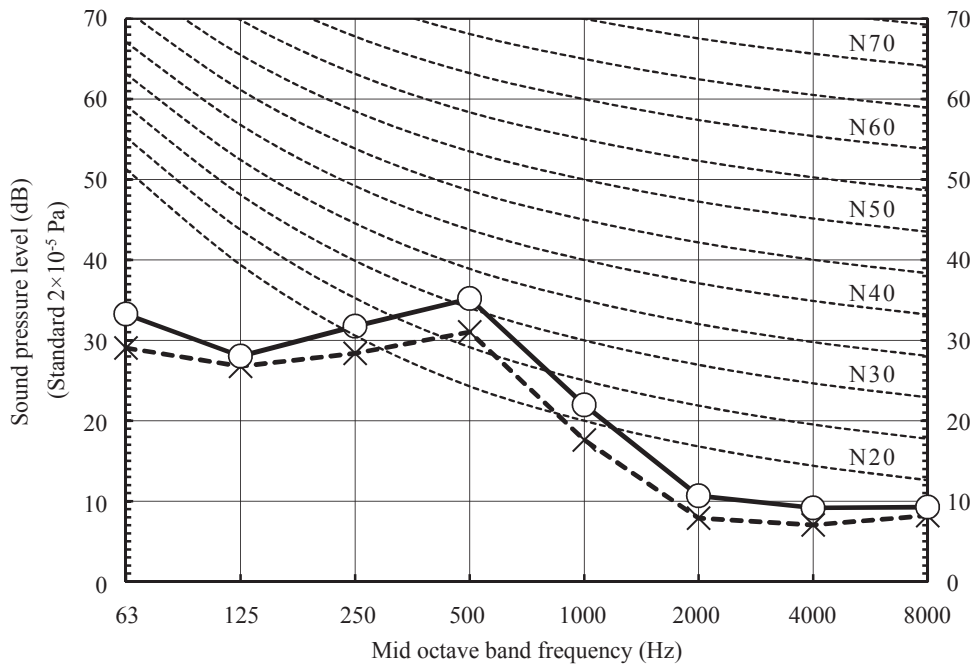

Model SRF50ZSX-W

(Indoor unit)

Model	SRF50ZSX-W	
Noise	Cooling	38 dB(A)
Level	Heating	41 dB(A)

Condition	ISO15042 T1/H1
-----------	----------------

MODE	Me
------	----

●Mike position

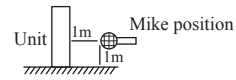

× Cooling, ○ — Heating

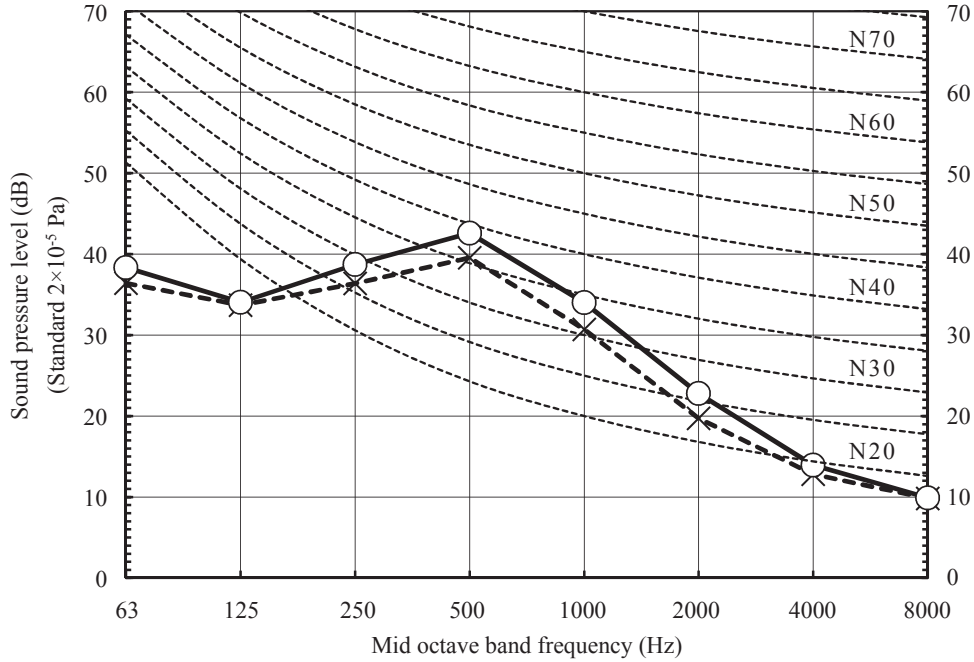

(Indoor unit)

Model	SRF50ZSX-W	
Noise	Cooling	33 dB(A)
Level	Heating	38 dB(A)

Condition	ISO15042 T1/H1
-----------	----------------

MODE	Lo
------	----

●Mike position

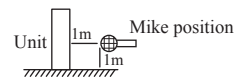

× Cooling, ○ — Heating

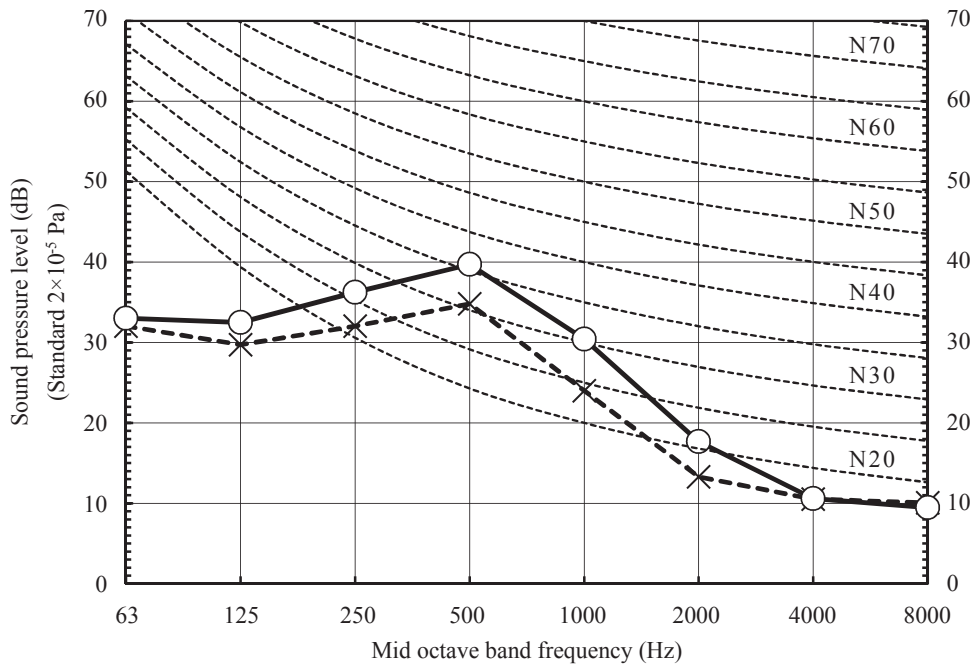

(Indoor unit)

Model	SRF50ZSX-W	
Noise Level	Cooling	28 dB(A)
	Heating	32 dB(A)

Condition	ISO15042 T1/H1
-----------	----------------

MODE	ULo
------	-----

●Mike position

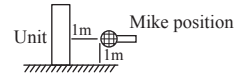

× Cooling, ○ — Heating

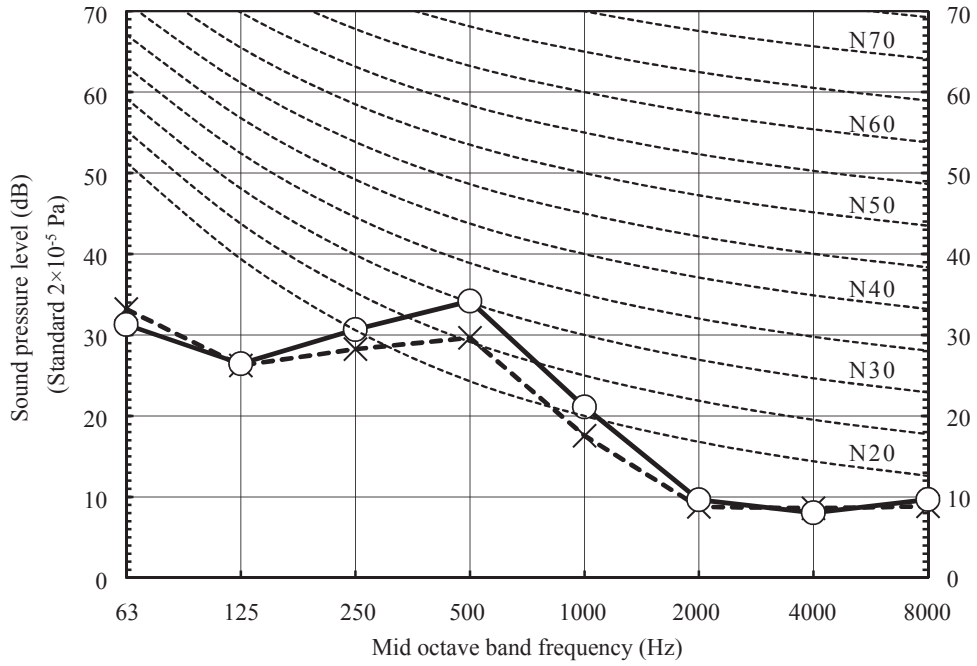

(3) Ceiling concealed type (SRR)

(a) SRR-ZM-W series

(i) Sound power level

Model SRR25ZM-W

• Non duct

(Indoor unit)

Model	SRR25ZM-W	
Noise Level	Cooling	56 dB(A)
	Heating	59 dB(A)

Condition	ISO15042 T1/H1
-----------	----------------

MODE	Rated capacity value (Hi)
------	---------------------------



x Cooling, ○ — Heating

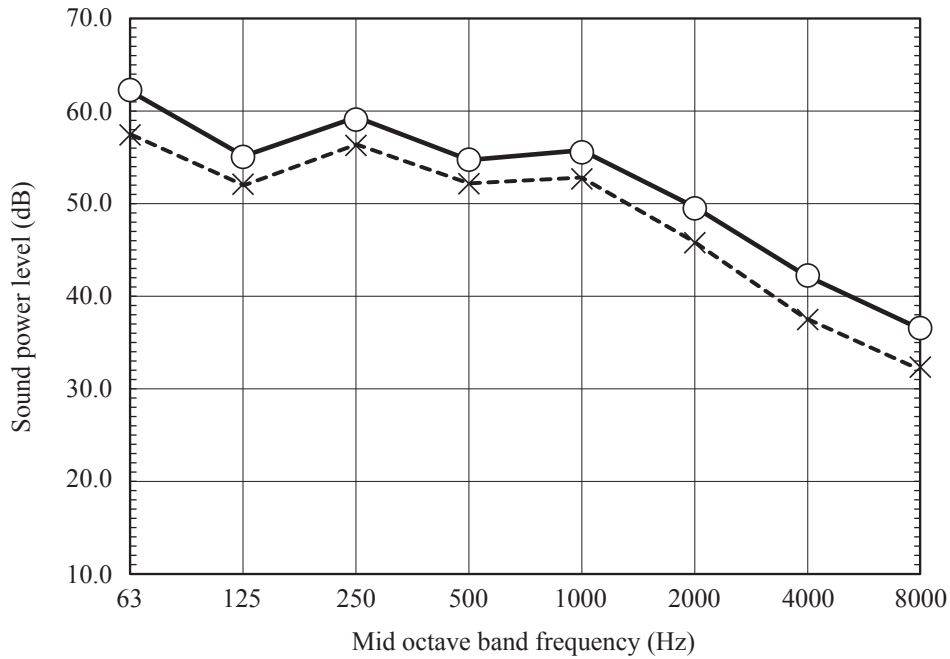

• With duct

(Indoor unit)

Model	SRR25ZM-W	
Noise Level	Cooling	56 dB(A)
	Heating	59 dB(A)

Condition	ISO15042 T1/H1
-----------	----------------

MODE	Rated capacity value (Hi)
------	---------------------------

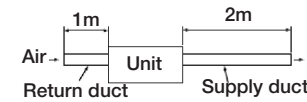

External static pressure : 10Pa

x Cooling, ○ — Heating

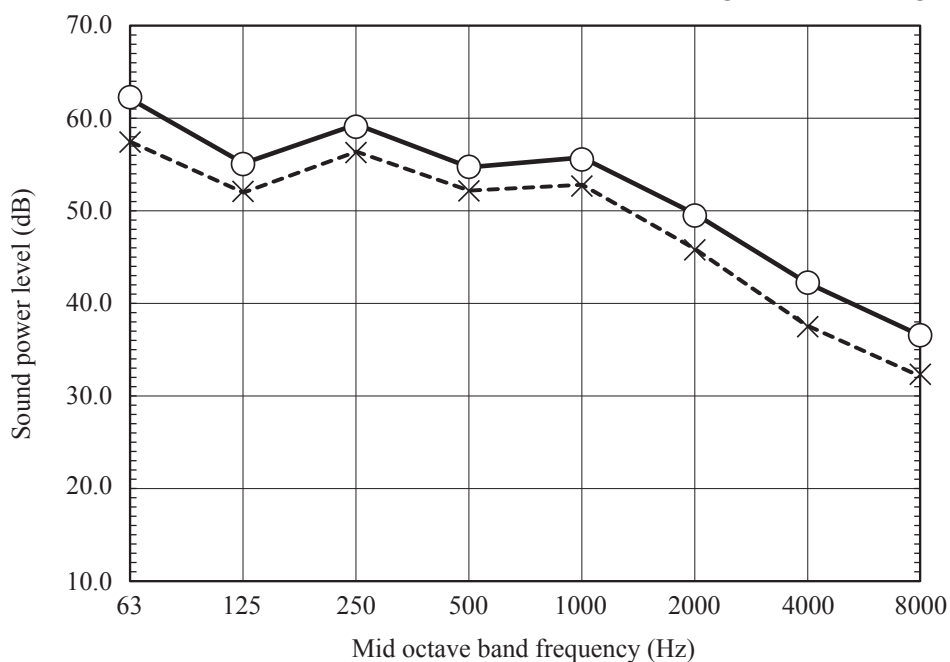

Model SRR35ZM-W
• Non duct

(Indoor unit)

Model	SRR35ZM-W	
Noise Level	Cooling	57 dB(A)
	Heating	60 dB(A)

Condition	ISO15042 T1/H1
-----------	----------------

MODE	Rated capacity value (Hi)
------	---------------------------



x Cooling, ○ — Heating

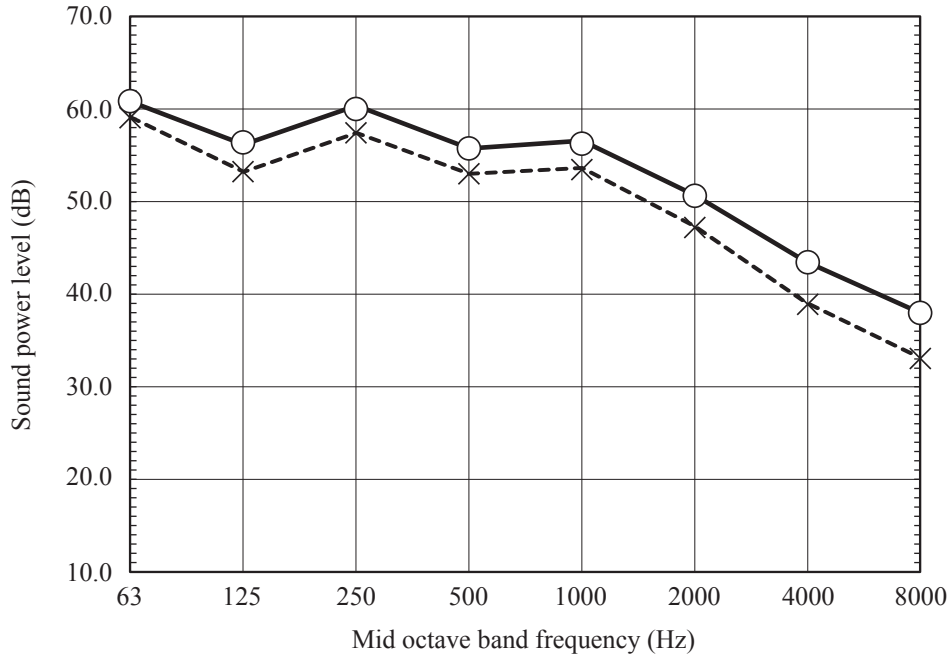

• With duct

(Indoor unit)

Model	SRR35ZM-W	
Noise Level	Cooling	57 dB(A)
	Heating	60 dB(A)

Condition	ISO15042 T1/H1
-----------	----------------

MODE	Rated capacity value (Hi)
------	---------------------------

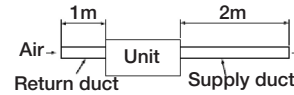

External static pressure : 10Pa

x Cooling, ○ — Heating

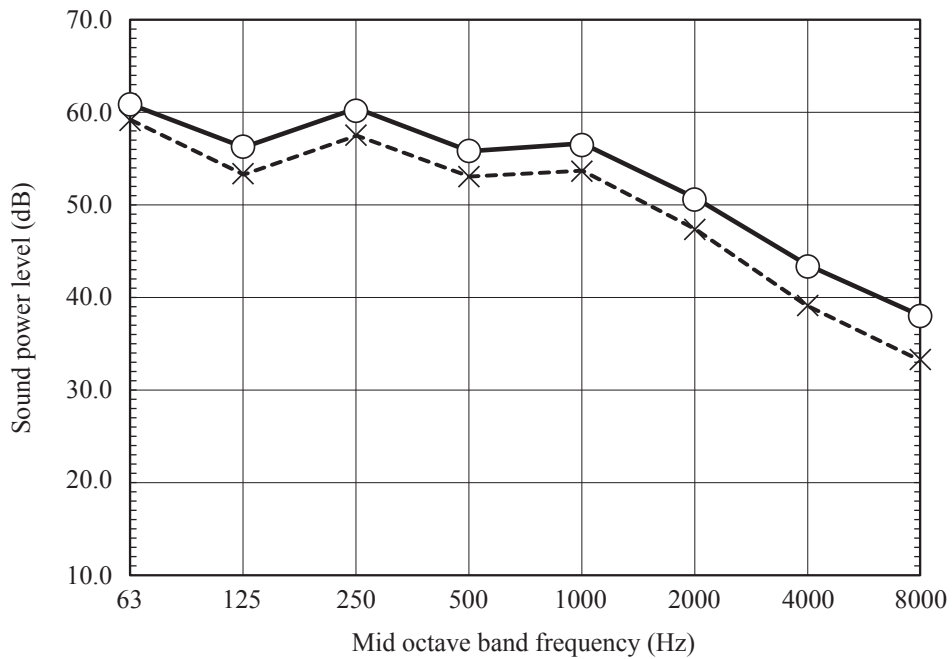

- (ii) Sound pressure level
 - 1) Rated capacity value (Hi)
 - Model SRR25ZM-W
 - Sound pressure level ①

(Indoor unit)

Model	SRR25ZM-W	
Noise	Cooling	37 dB(A)
Level	Heating	40 dB(A)

Condition	ISO15042 T1/H1
-----------	----------------

MODE	Rated capacity value (Hi)
------	---------------------------

- Mike position

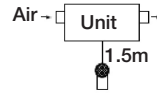

x Cooling, ○ — Heating

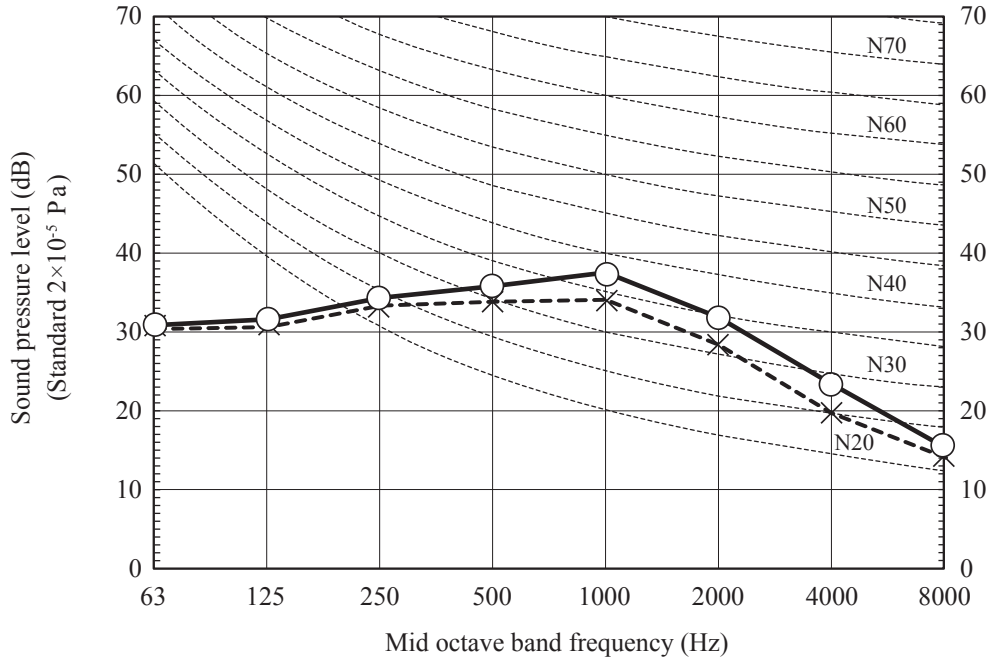

- Sound pressure level ②

(Indoor unit)

Model	SRR25ZM-W	
Noise	Cooling	31 dB(A)
Level	Heating	33 dB(A)

Condition	ISO15042 T1/H1
-----------	----------------

MODE	Rated capacity value (Hi)
------	---------------------------

- Mike position

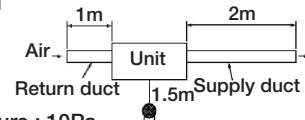

External static pressure : 10Pa

x Cooling, ○ — Heating

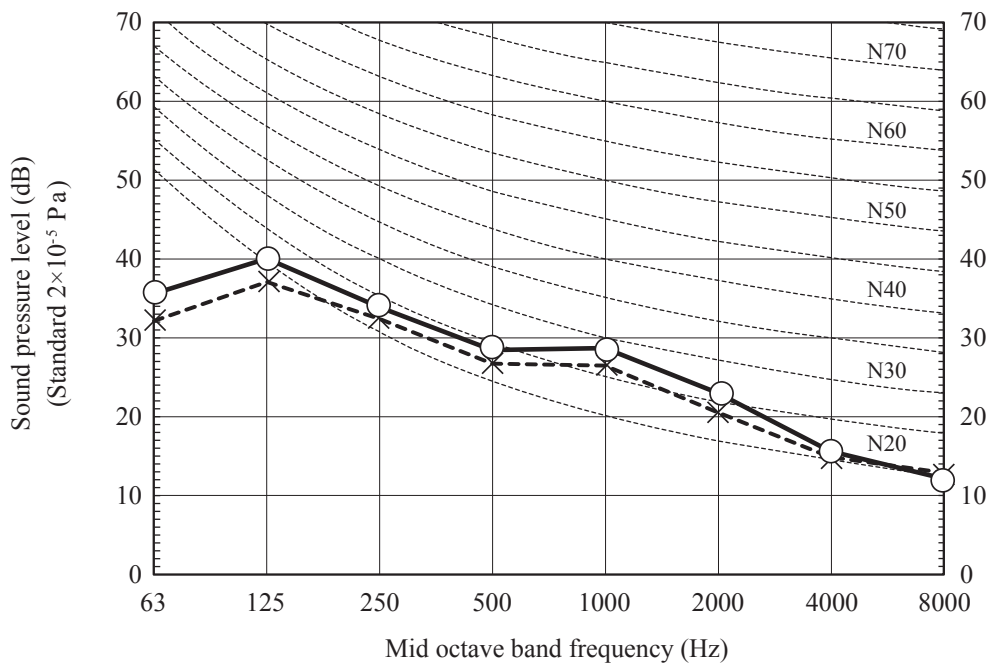

• Sound pressure level ③

(Indoor unit)

Model	SRR25ZM-W	
Noise Level	Cooling	39 dB(A)
	Heating	44 dB(A)

Condition	ISO15042 T1/H1
-----------	----------------

MODE	Rated capacity value (Hi)
------	---------------------------

• Mike position

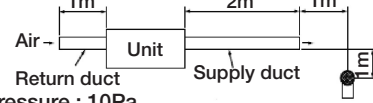

External static pressure : 10Pa

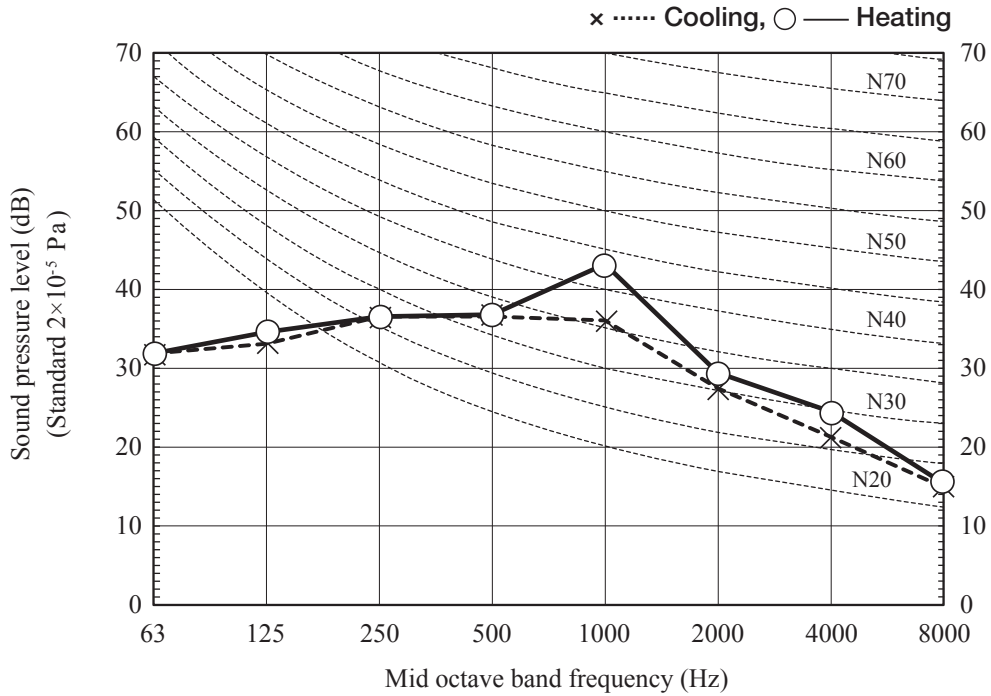

Model SRR35ZM-W

• Sound pressure level ①

(Indoor unit)

Model	SRR35ZM-W	
Noise Level	Cooling	38 dB(A)
	Heating	42 dB(A)

Condition	ISO15042 T1/H1
-----------	----------------

MODE	Rated capacity value (Hi)
------	---------------------------

• Mike position

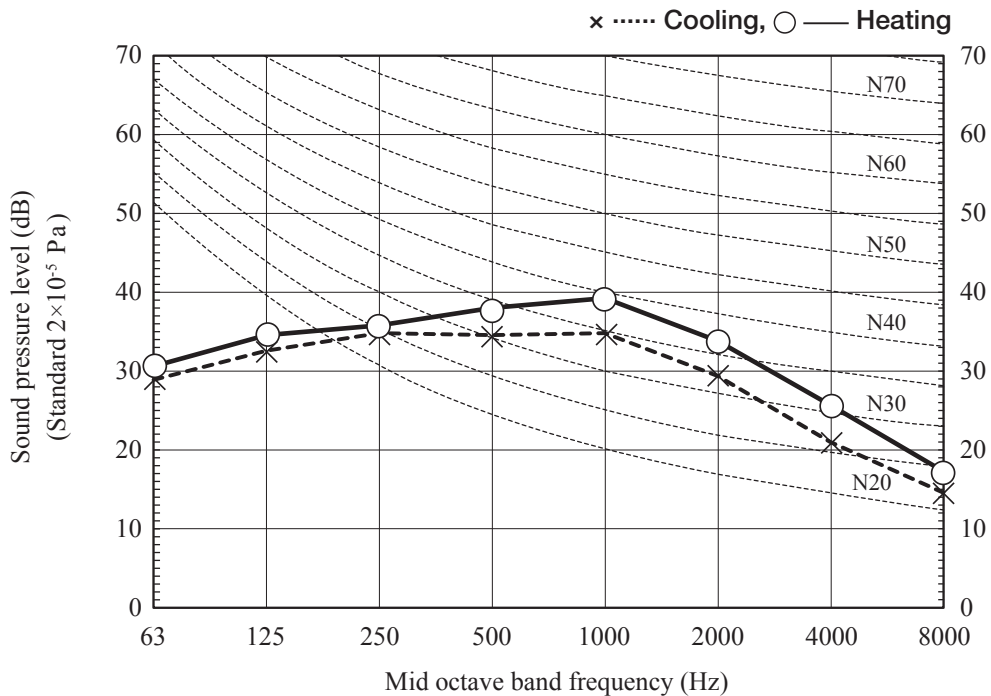
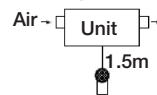

• Sound pressure level ②

(Indoor unit)

Model	SRR35ZM-W	
Noise Level	Cooling	33 dB(A)
	Heating	34 dB(A)

Condition	ISO15042 T1/H1
-----------	----------------

MODE	Rated capacity value (Hi)
------	---------------------------

• Mike position

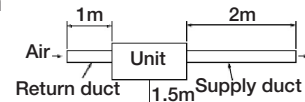

External static pressure : 10Pa

x Cooling, ○ — Heating

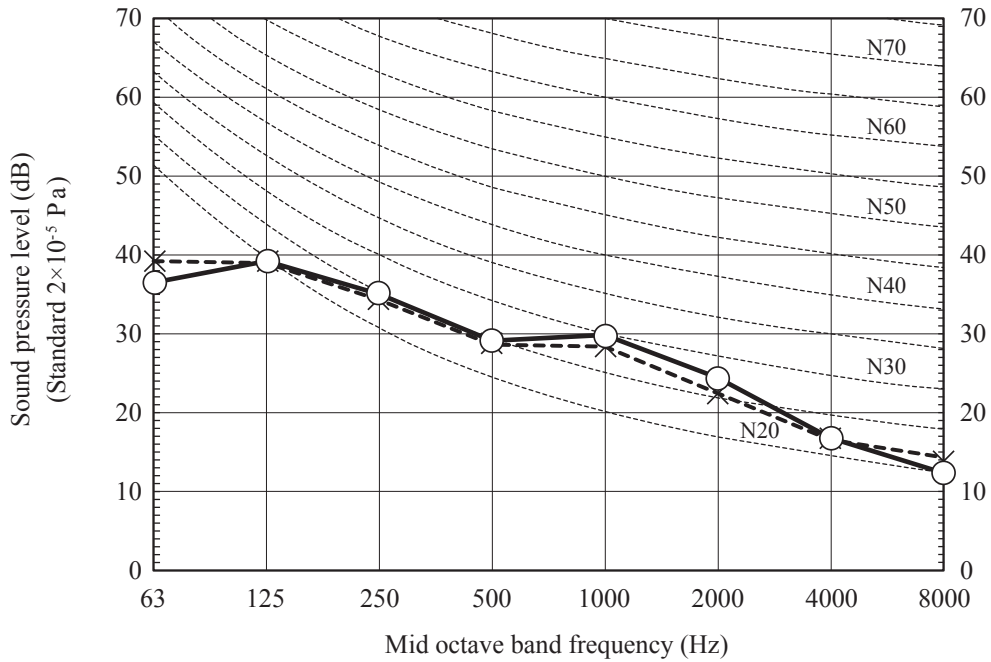

• Sound pressure level ③

(Indoor unit)

Model	SRR35ZM-W	
Noise Level	Cooling	40 dB(A)
	Heating	45 dB(A)

Condition	ISO15042 T1/H1
-----------	----------------

MODE	Rated capacity value (Hi)
------	---------------------------

• Mike position

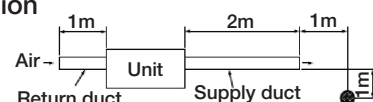

External static pressure : 10Pa

x Cooling, ○ — Heating

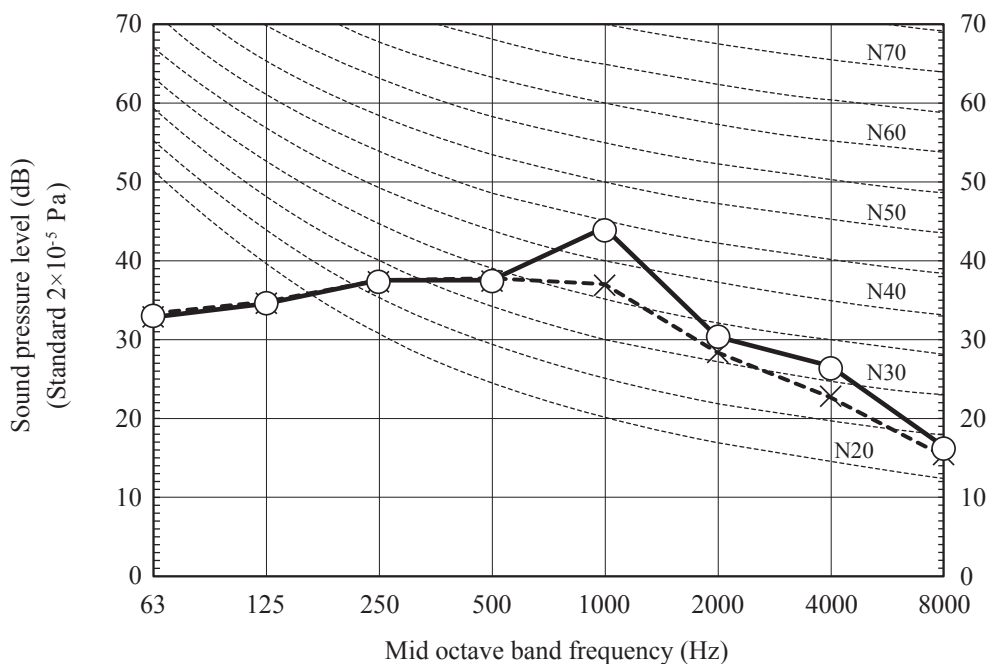

2) Each fan speed mode

Model SRR25ZM-W

• Sound pressure level ①

(Indoor unit)

Model	SRR25ZM-W	
Noise	Cooling	33 dB(A)
Level	Heating	37 dB(A)

Condition	ISO15042 T1/H1
-----------	----------------

MODE	Me
------	----

● Mike position

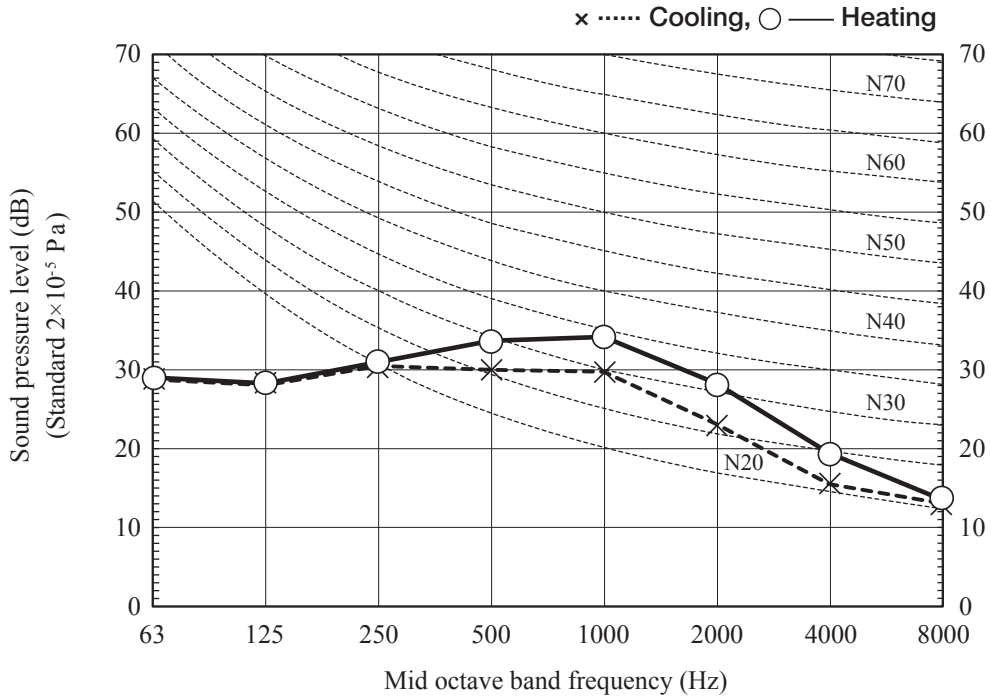
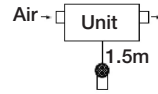

(Indoor unit)

Model	SRR25ZM-W	
Noise	Cooling	30 dB(A)
Level	Heating	34 dB(A)

Condition	ISO15042 T1/H1
-----------	----------------

MODE	Lo
------	----

● Mike position

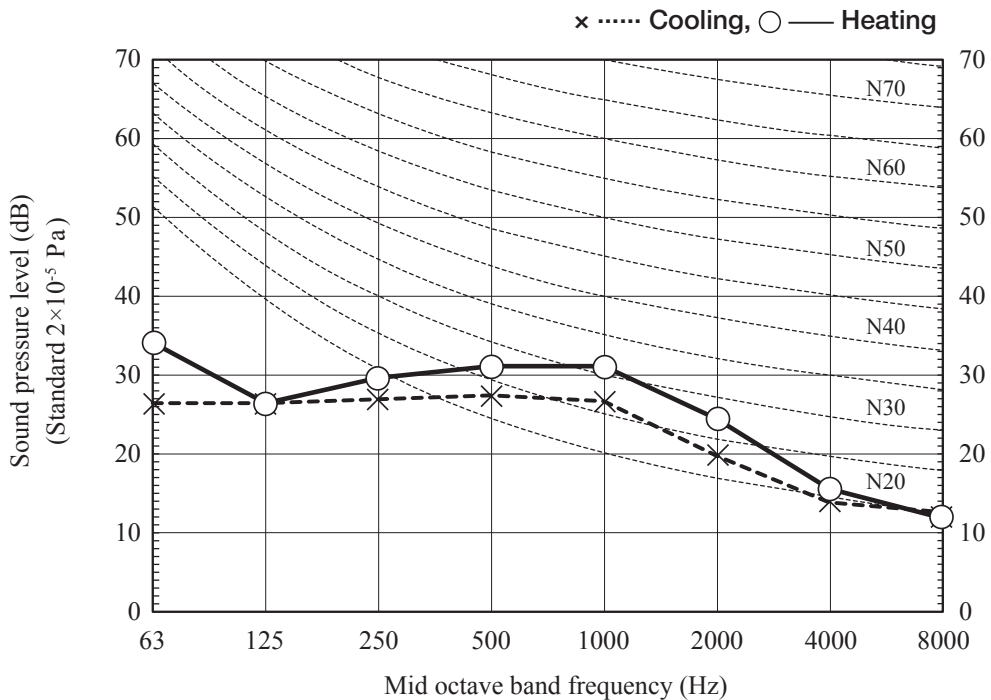
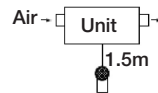

(Indoor unit)

Model	SRR25ZM-W	
Noise Level	Cooling	24 dB(A)
	Heating	28 dB(A)

Condition	ISO15042 T1/H1
-----------	----------------

MODE	ULo
------	-----

● Mike position

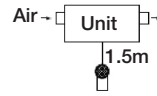

× Cooling, ○ — Heating

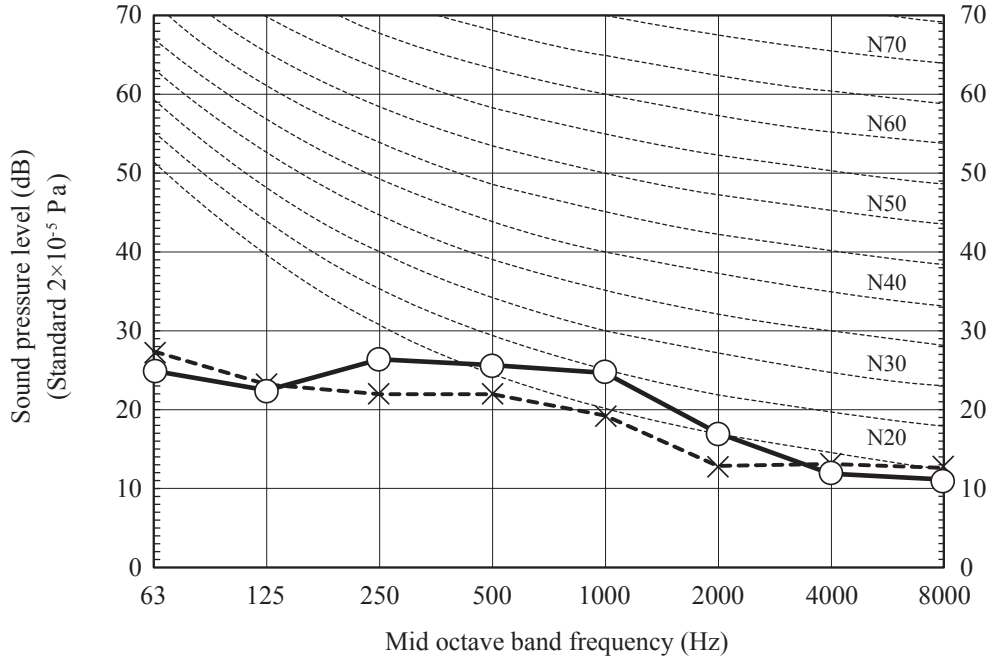

● Sound pressure level ②

(Indoor unit)

Model	SRR25ZM-W	
Noise Level	Cooling	28 dB(A)
	Heating	30 dB(A)

Condition	ISO15042 T1/H1
-----------	----------------

MODE	Me
------	----

● Mike position

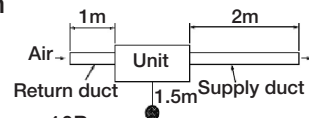

External static pressure : 10Pa

× Cooling, ○ — Heating

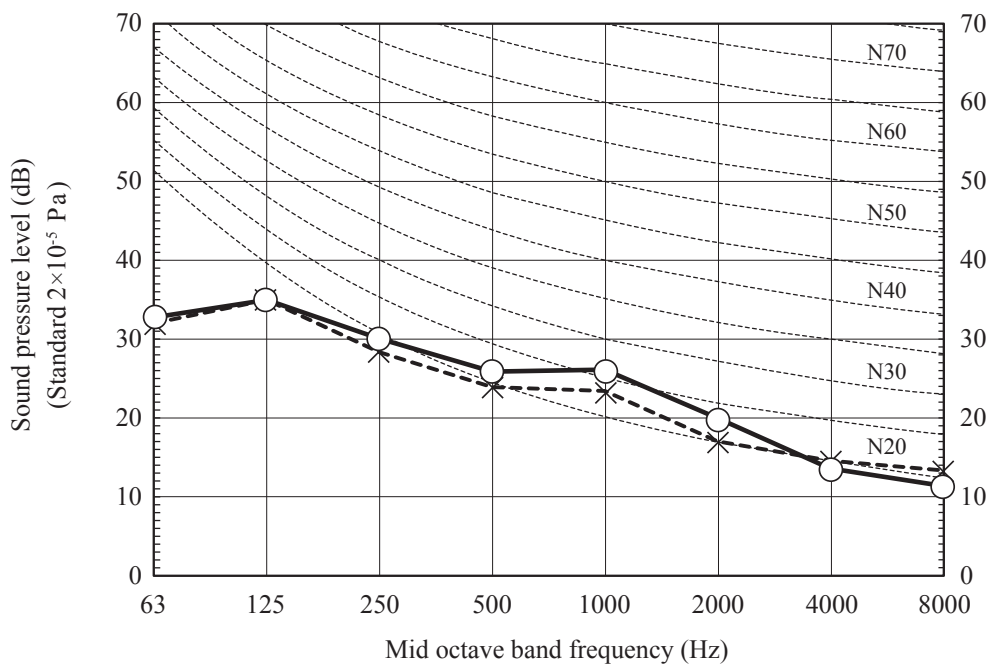

(Indoor unit)

Model	SRR25ZM-W	
Noise Level	Cooling	26 dB(A)
	Heating	28 dB(A)

Condition	ISO15042 T1/H1
-----------	----------------

MODE	Lo
------	----

● Mike position

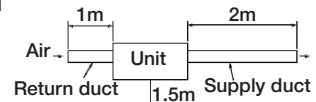

External static pressure : 10Pa

x Cooling, ○ — Heating

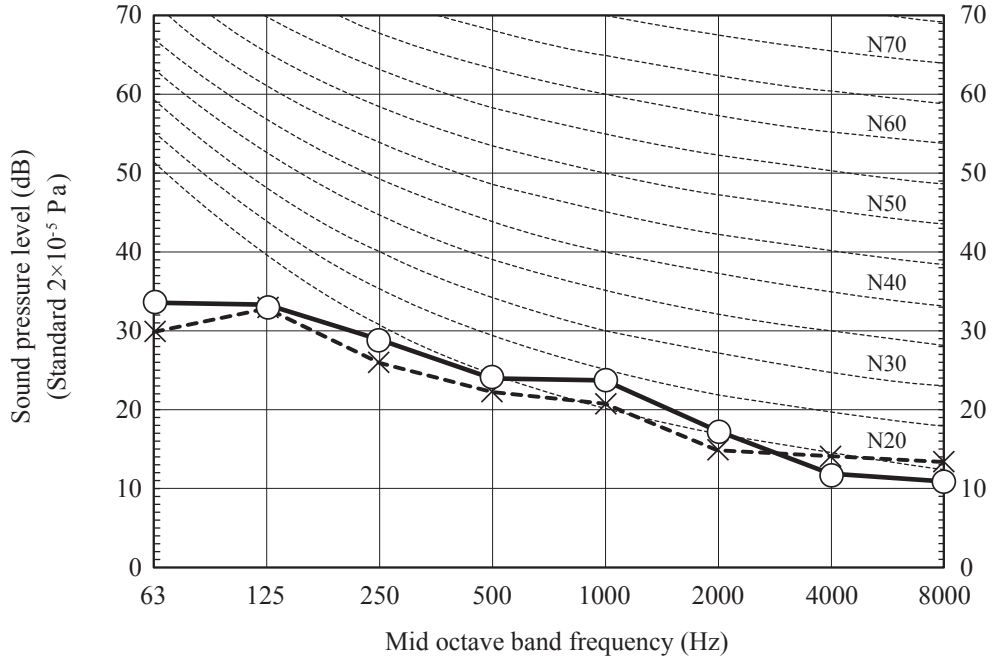

(Indoor unit)

Model	SRR25ZM-W	
Noise Level	Cooling	21 dB(A)
	Heating	23 dB(A)

Condition	ISO15042 T1/H1
-----------	----------------

MODE	ULo
------	-----

● Mike position

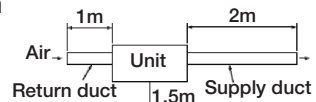

External static pressure : 10Pa

x Cooling, ○ — Heating

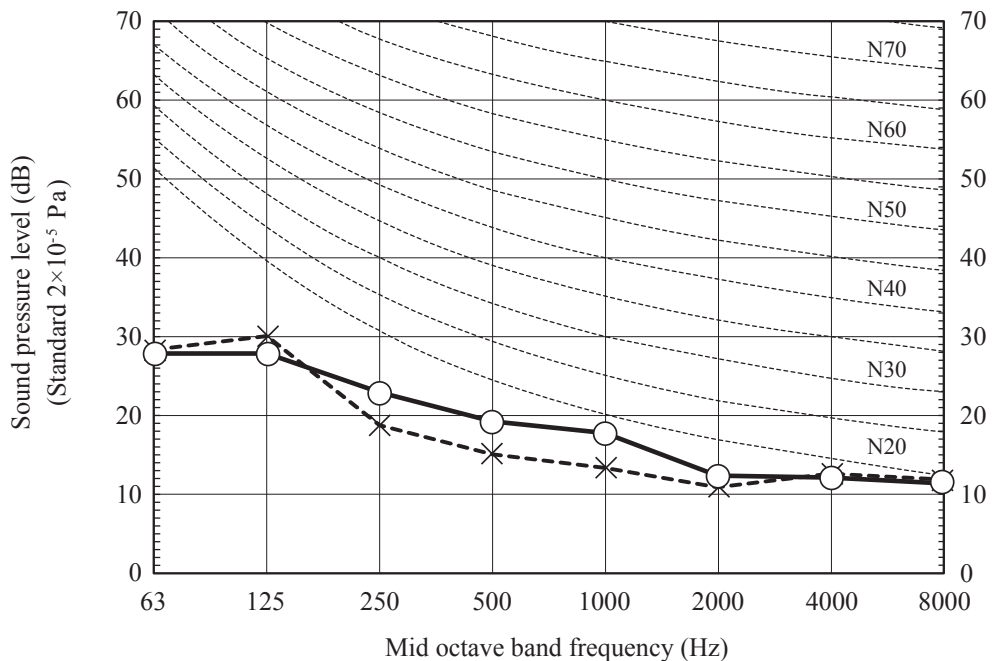

• Sound pressure level ③

(Indoor unit)

Model	SRR25ZM-W	
Noise Level	Cooling	35 dB(A)
	Heating	41 dB(A)

Condition	ISO15042 T1/H1
-----------	----------------

MODE	Me
------	----

• Mike position

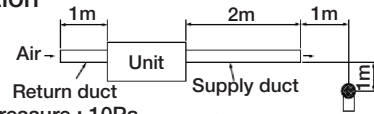

External static pressure : 10Pa

x Cooling, ○ — Heating

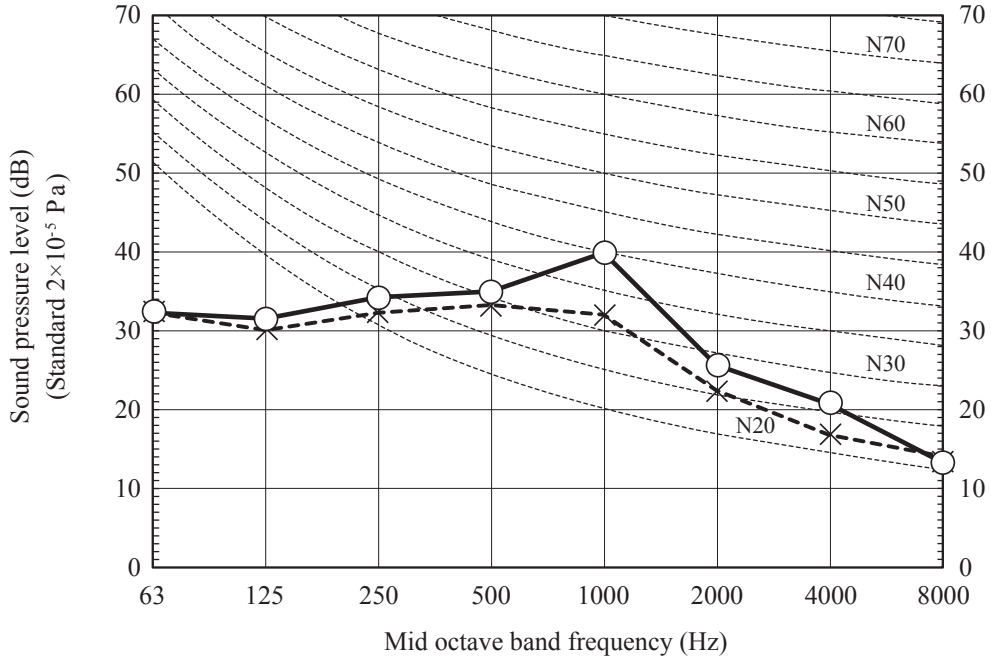

(Indoor unit)

Model	SRR25ZM-W	
Noise Level	Cooling	32 dB(A)
	Heating	38 dB(A)

Condition	ISO15042 T1/H1
-----------	----------------

MODE	Lo
------	----

• Mike position

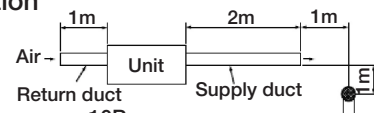

External static pressure : 10Pa

x Cooling, ○ — Heating

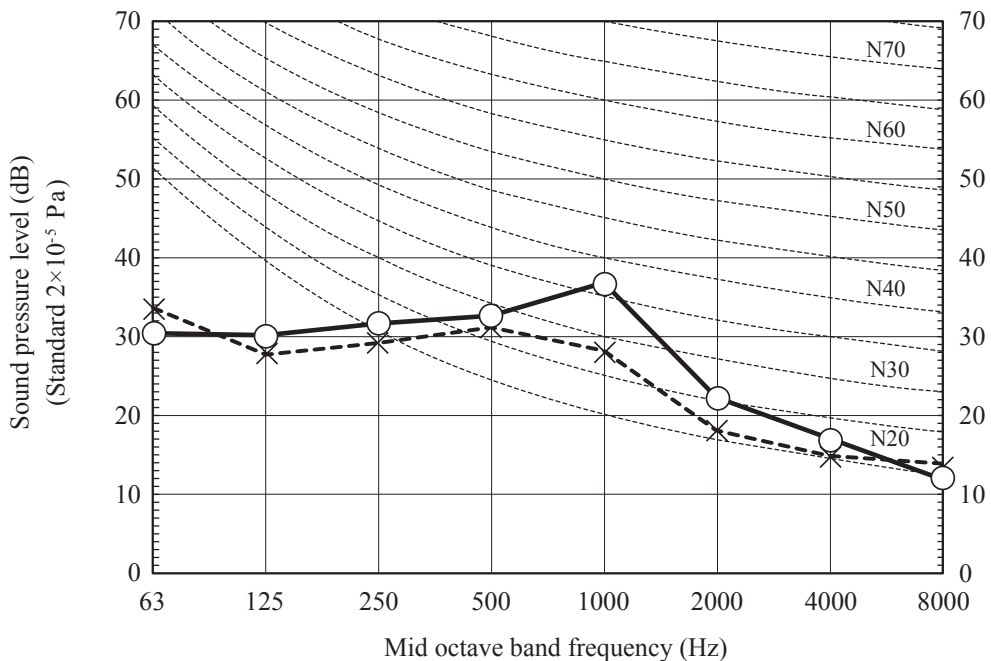

(Indoor unit)

Model	SRR25ZM-W	
Noise Level	Cooling	25 dB(A)
	Heating	31 dB(A)

Condition	ISO15042 T1/H1
-----------	----------------

MODE	ULo
------	-----

● Mike position

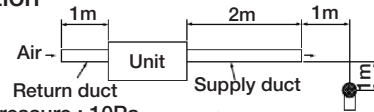

External static pressure : 10Pa

x Cooling, ○ — Heating

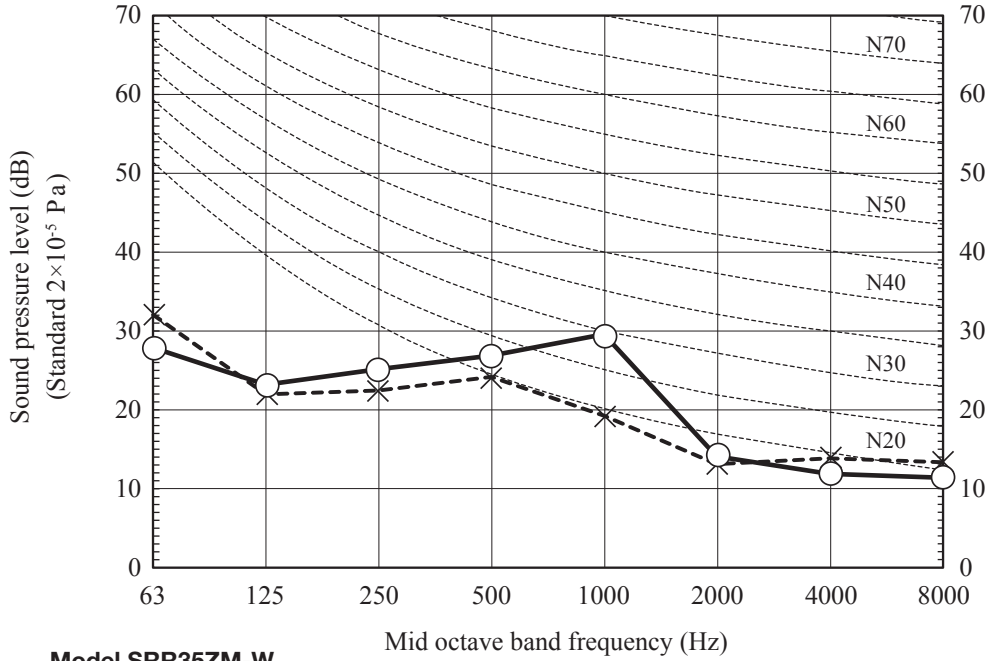

Model SRR35ZM-W

● Sound pressure level ①

(Indoor unit)

Model	SRR35ZM-W	
Noise Level	Cooling	34 dB(A)
	Heating	38 dB(A)

Condition	ISO15042 T1/H1
-----------	----------------

MODE	Me
------	----

● Mike position

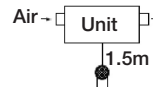

External static pressure : 10Pa

x Cooling, ○ — Heating

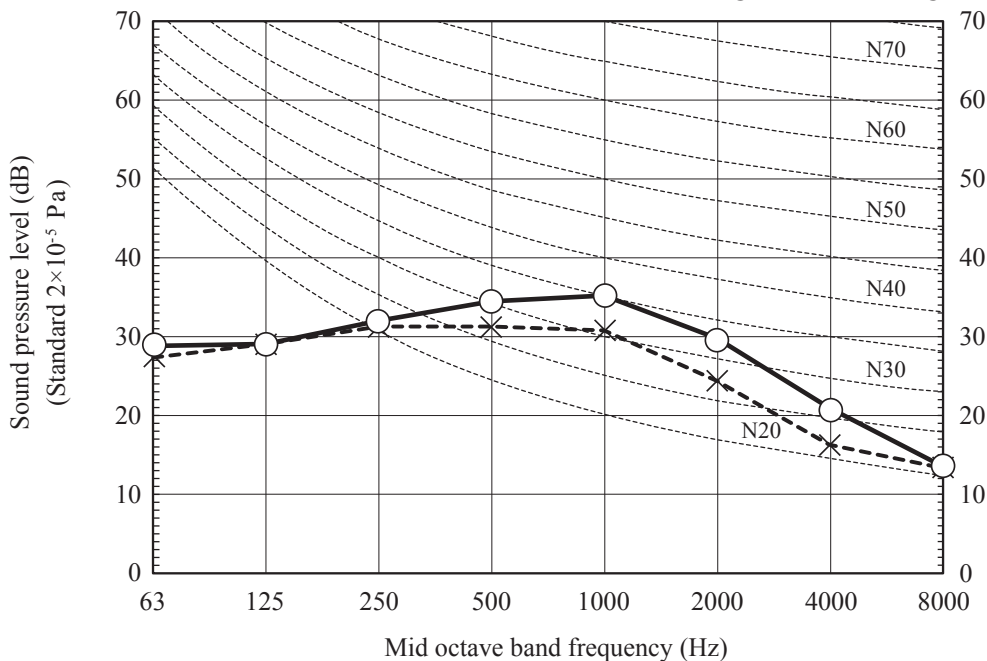

(Indoor unit)

Model	SRR35ZM-W	
Noise Level	Cooling	31 dB(A)
	Heating	35 dB(A)

Condition	ISO15042 T1/H1
-----------	----------------

MODE	Lo
------	----

● Mike position

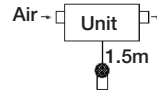

× Cooling, ○ — Heating

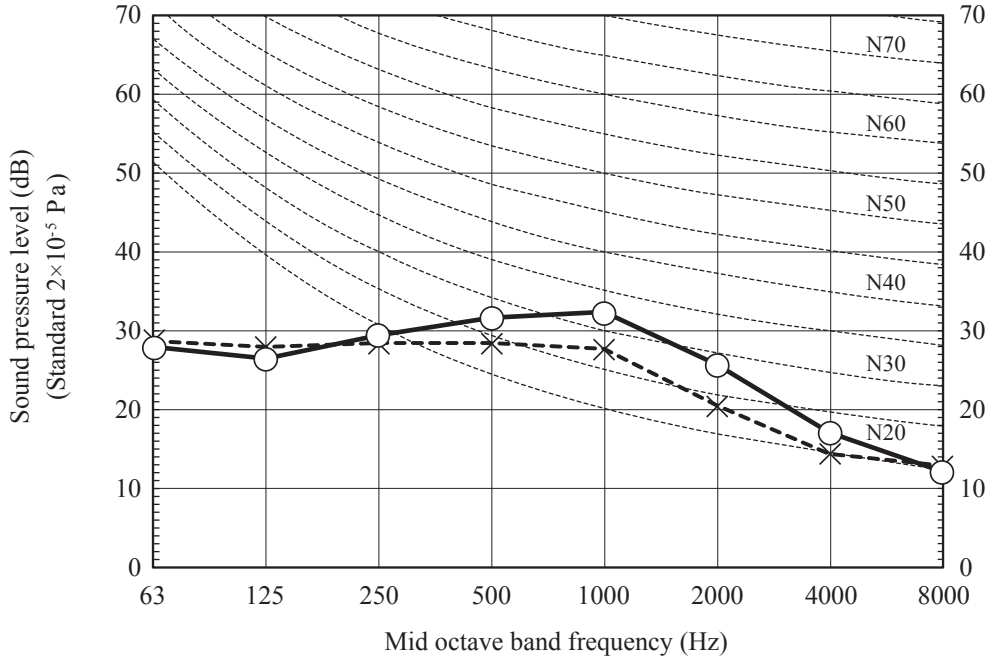

(Indoor unit)

Model	SRR35ZM-W	
Noise Level	Cooling	25 dB(A)
	Heating	29 dB(A)

Condition	ISO15042 T1/H1
-----------	----------------

MODE	ULo
------	-----

● Mike position

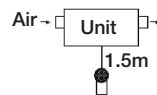

× Cooling, ○ — Heating

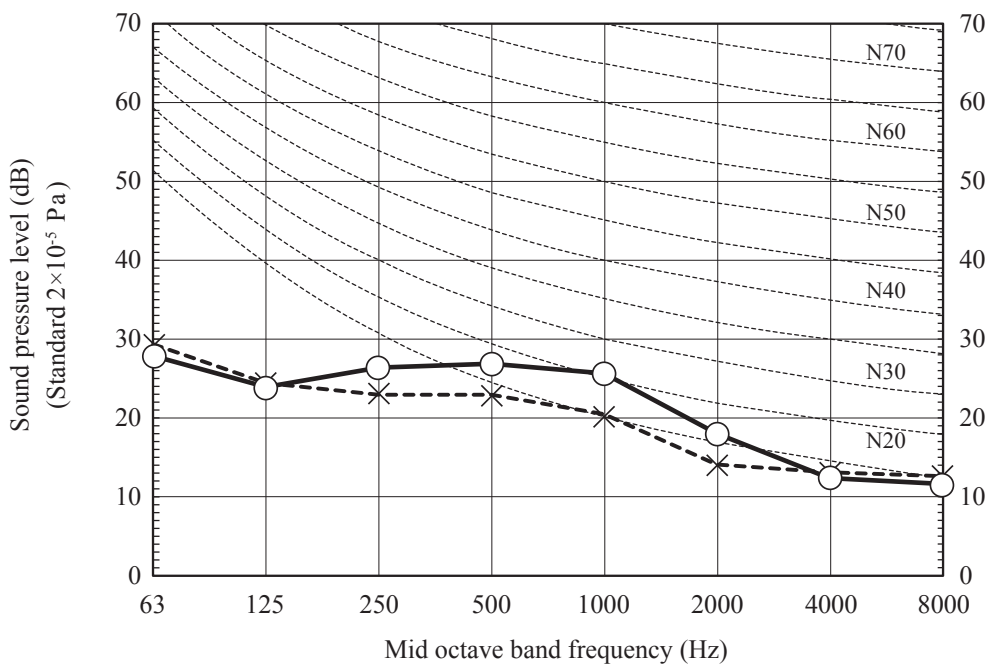

• Sound pressure level ②

(Indoor unit)

Model	SRR35ZM-W	
Noise Level	Cooling	30 dB(A)
	Heating	32 dB(A)

Condition	ISO15042 T1/H1
-----------	----------------

MODE	Me
------	----

• Mike position

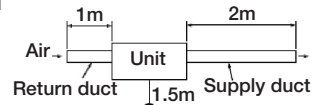

External static pressure : 10Pa

x Cooling, ○ — Heating

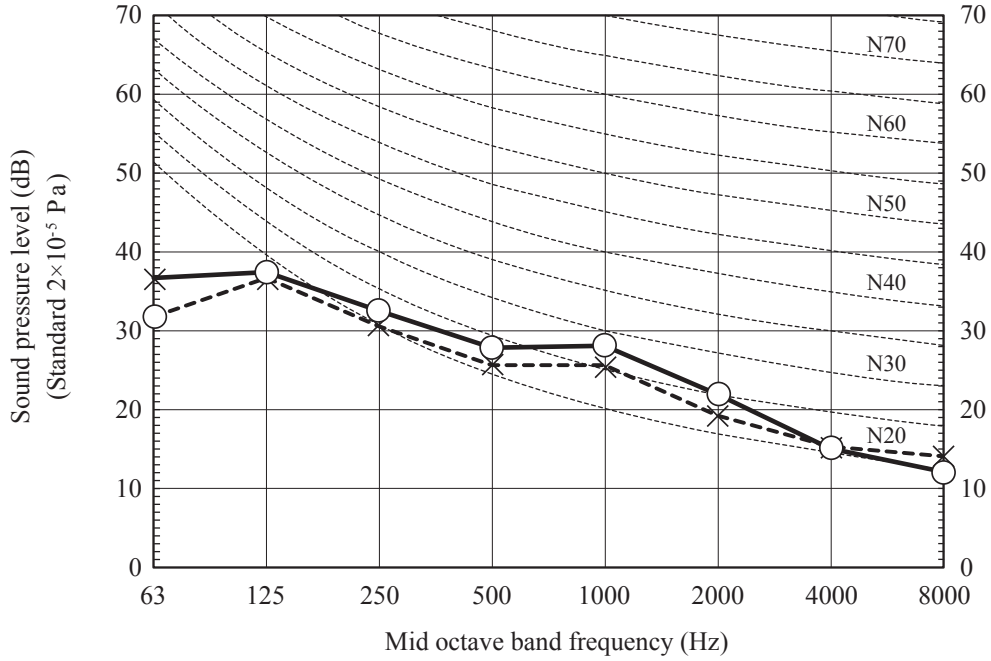

(Indoor unit)

Model	SRR35ZM-W	
Noise Level	Cooling	27 dB(A)
	Heating	29 dB(A)

Condition	ISO15042 T1/H1
-----------	----------------

MODE	Lo
------	----

• Mike position

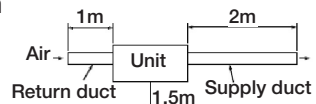

External static pressure : 10Pa

x Cooling, ○ — Heating

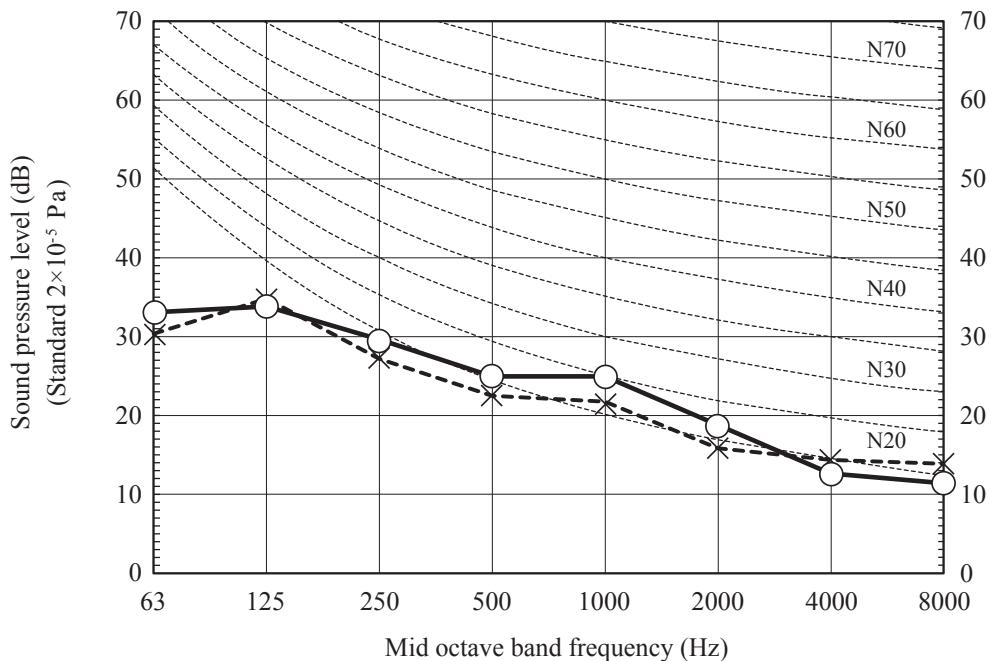

(Indoor unit)

Model	SRR35ZM-W	
Noise Level	Cooling	22 dB(A)
	Heating	24 dB(A)

Condition	ISO15042 T1/H1
-----------	----------------

MODE	ULo
------	-----

● Mike position

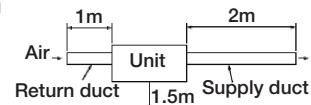

External static pressure : 10Pa

x Cooling, ○ — Heating

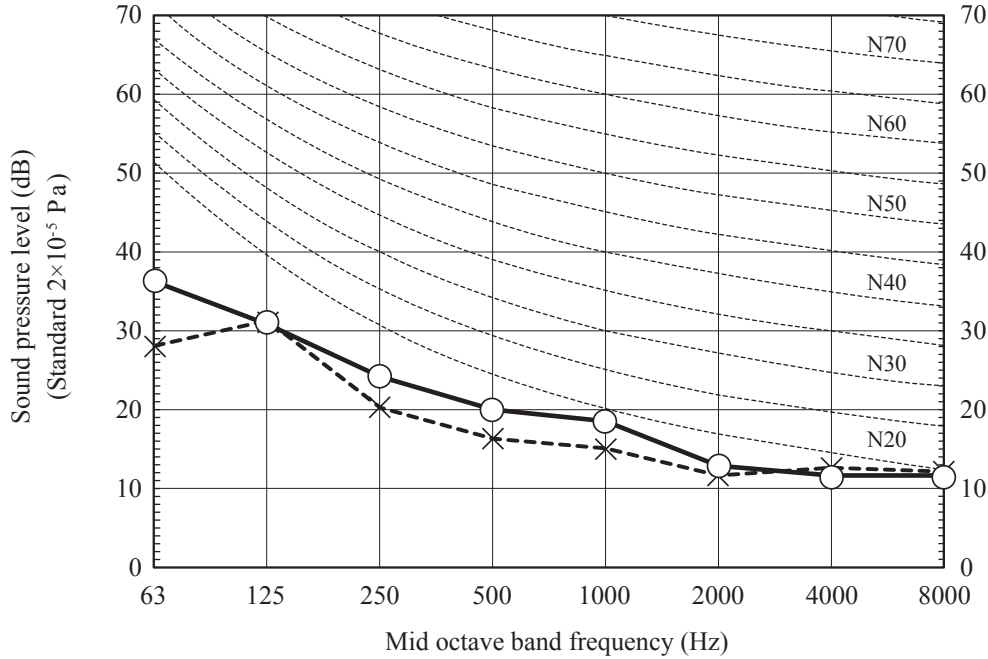

● Sound pressure level ③

(Indoor unit)

Model	SRR35ZM-W	
Noise Level	Cooling	37 dB(A)
	Heating	42 dB(A)

Condition	ISO15042 T1/H1
-----------	----------------

MODE	Me
------	----

● Mike position

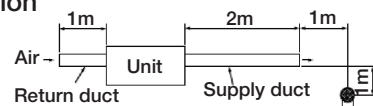

External static pressure : 10Pa

x Cooling, ○ — Heating

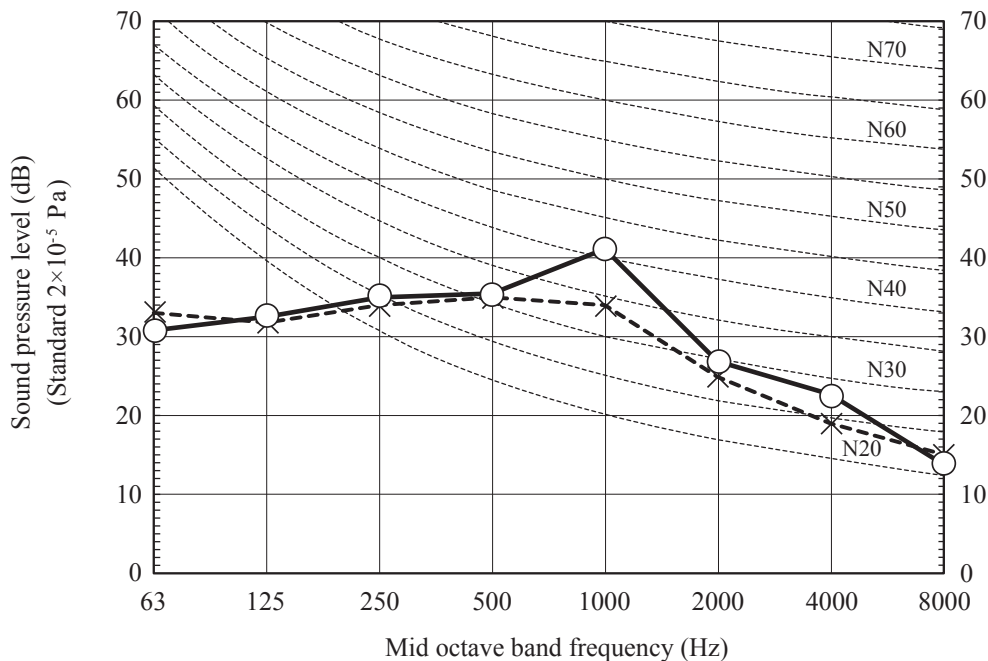

(Indoor unit)

Model	SRR35ZM-W	
Noise Level	Cooling	33 dB(A)
	Heating	39 dB(A)

Condition	ISO15042 T1/H1
-----------	----------------

MODE	Lo
------	----

● Mike position

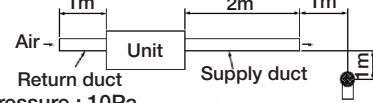

External static pressure : 10Pa

x Cooling, ○ — Heating

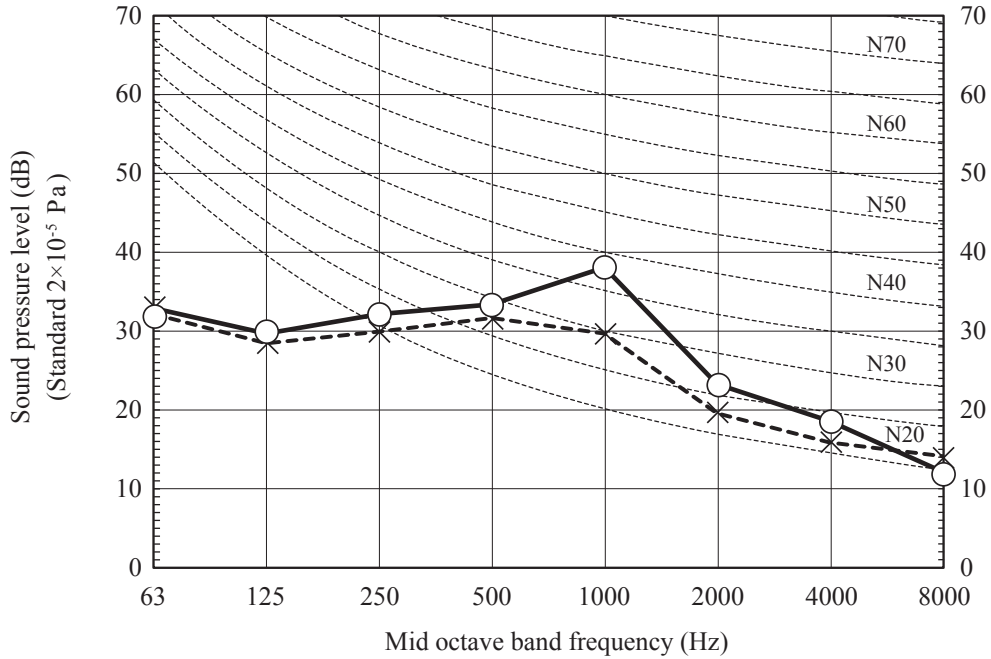

(Indoor unit)

Model	SRR35ZM-W	
Noise Level	Cooling	27 dB(A)
	Heating	33 dB(A)

Condition	ISO15042 T1/H1
-----------	----------------

MODE	ULo
------	-----

● Mike position

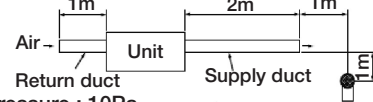

External static pressure : 10Pa

x Cooling, ○ — Heating

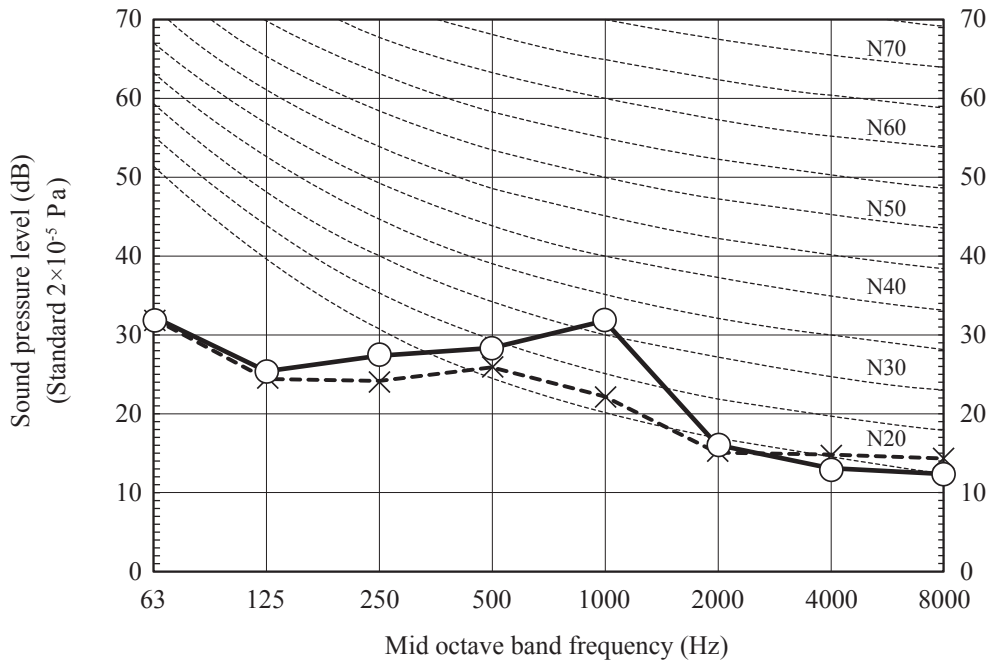

(b) SRR-ZS-W series

(i) Sound power level

Model SRR25ZS-W

•Non duct

(Indoor unit)

Model	SRR25ZS-W	
Noise level	Cooling	56 dB(A)
	Heating	59 dB(A)

Condition	ISO15042 T1/H1
-----------	----------------

MODE	Rated capacity value (Hi)
------	---------------------------



× Cooling ○ — Heating

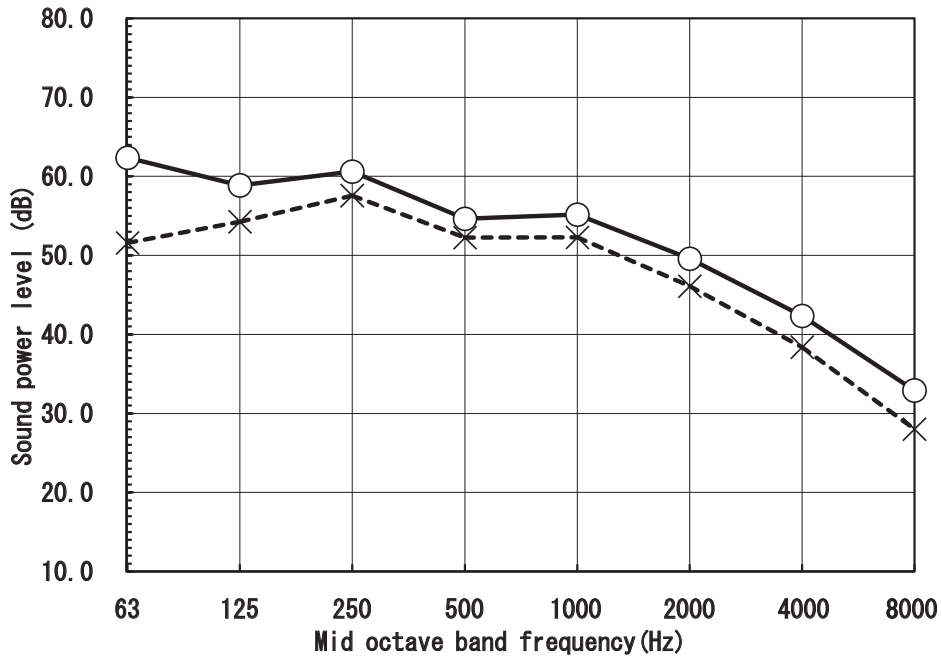

•With duct

(Indoor unit)

Model	SRR25ZS-W	
Noise level	Cooling	56 dB(A)
	Heating	59 dB(A)

Condition	ISO15042 T1/H1
-----------	----------------

MODE	Rated capacity value (Hi)
------	---------------------------

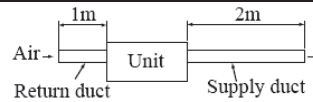

External static pressure : 10Pa

× Cooling ○ — Heating

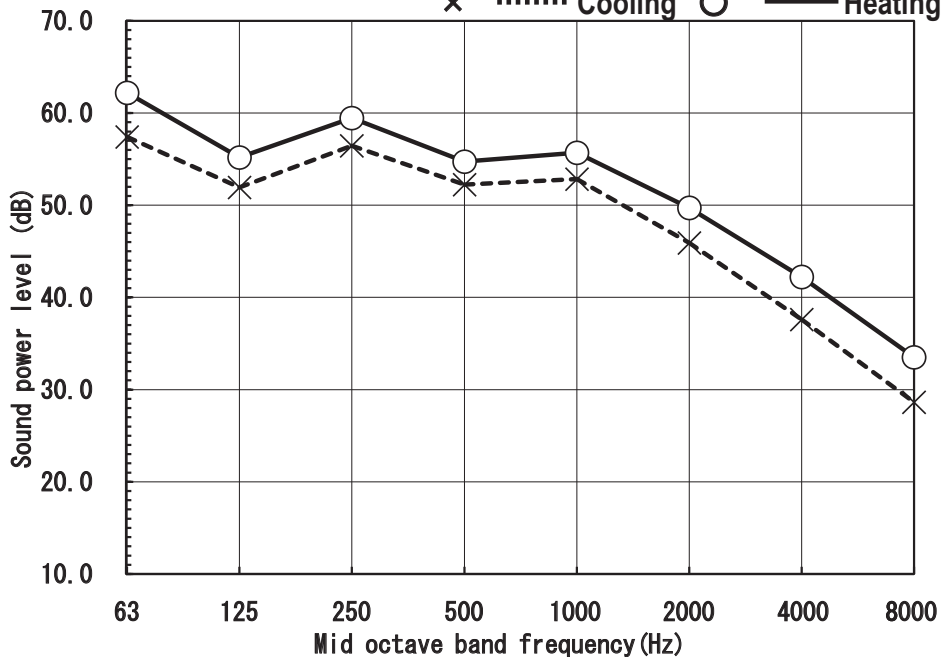

Model SRR35ZS-W

•Non duct

(Indoor unit)

Model	SRR35ZS-W	
Noise level	Cooling	56 dB(A)
	Heating	58 dB(A)

Condition	ISO15042 T1/H1
-----------	----------------

MODE	Rated capacity value (Hi)
------	---------------------------



× Cooling ○ — Heating

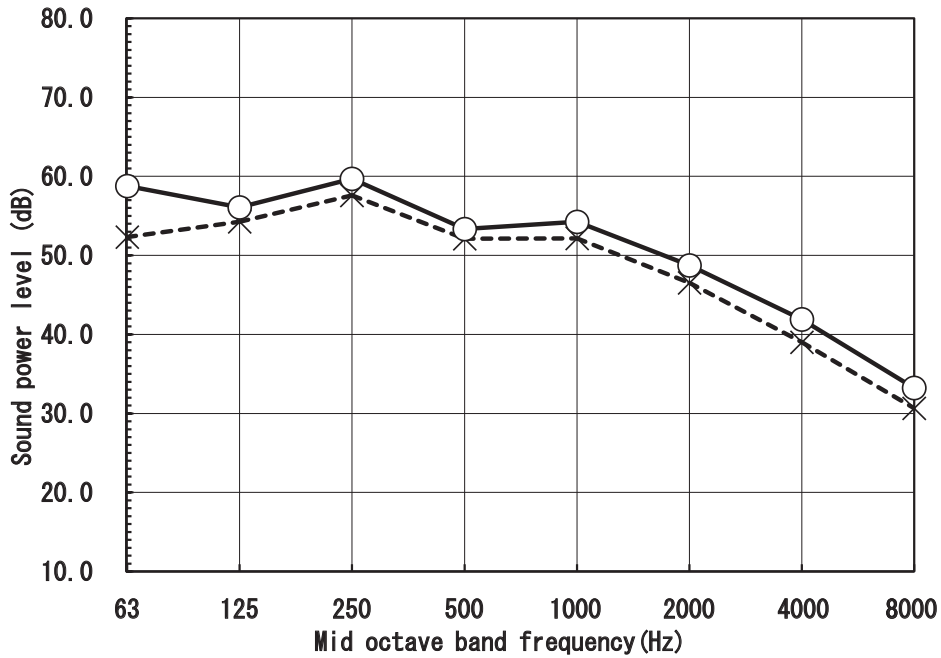

•With duct

(Indoor unit)

Model	SRR35ZS-W	
Noise level	Cooling	57 dB(A)
	Heating	60 dB(A)

Condition	ISO15042 T1/H1
-----------	----------------

MODE	Rated capacity value (Hi)
------	---------------------------

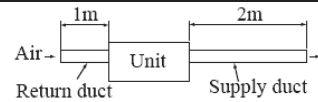

External static pressure : 10Pa

× Cooling ○ — Heating

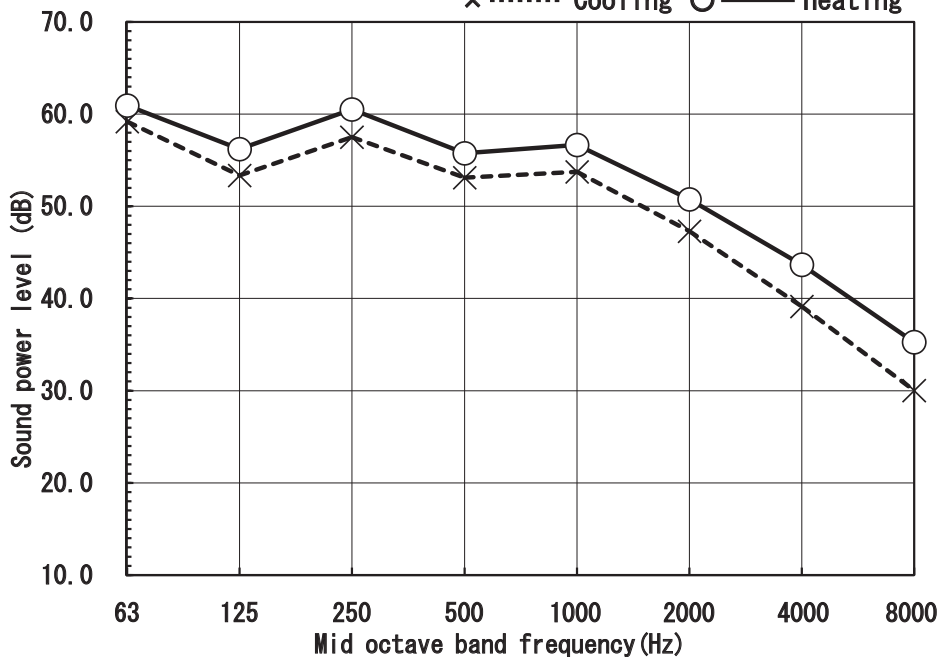

Model SRR50ZS-W
• Non duct

(Indoor unit)

Model	SRR50ZS-W	
Noise Level	Cooling	59 dB(A)
	Heating	61 dB(A)

Condition	ISO15042 T1/H1
-----------	----------------

MODE	Rated capacity value (Hi)
------	---------------------------



x Cooling, ○ — Heating

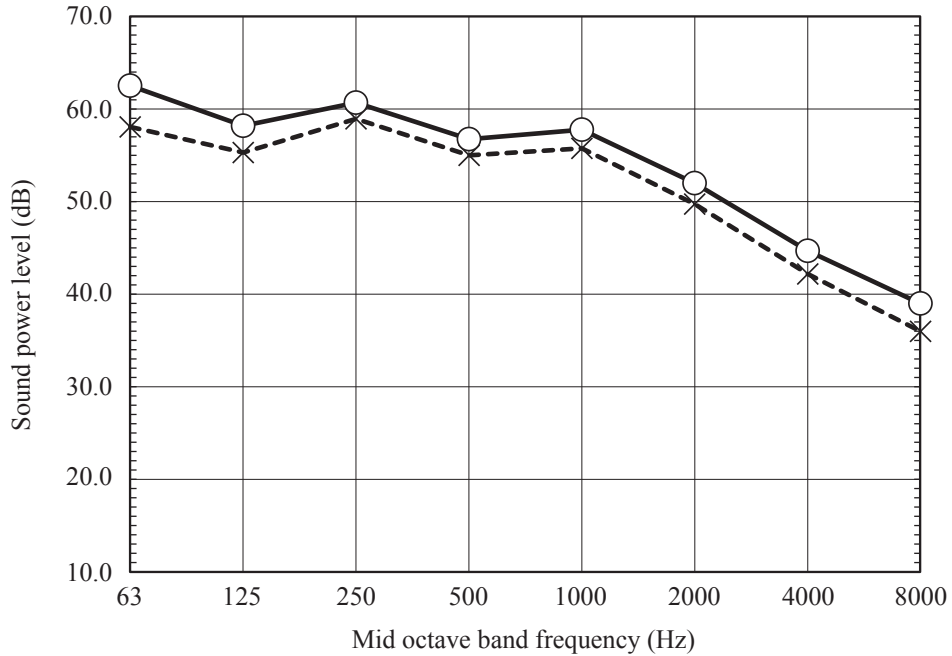

• With duct

(Indoor unit)

Model	SRR50ZS-W	
Noise Level	Cooling	59 dB(A)
	Heating	61 dB(A)

Condition	ISO15042 T1/H1
-----------	----------------

MODE	Rated capacity value (Hi)
------	---------------------------

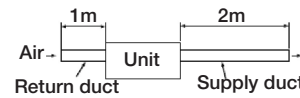

External static pressure : 10Pa

x Cooling, ○ — Heating

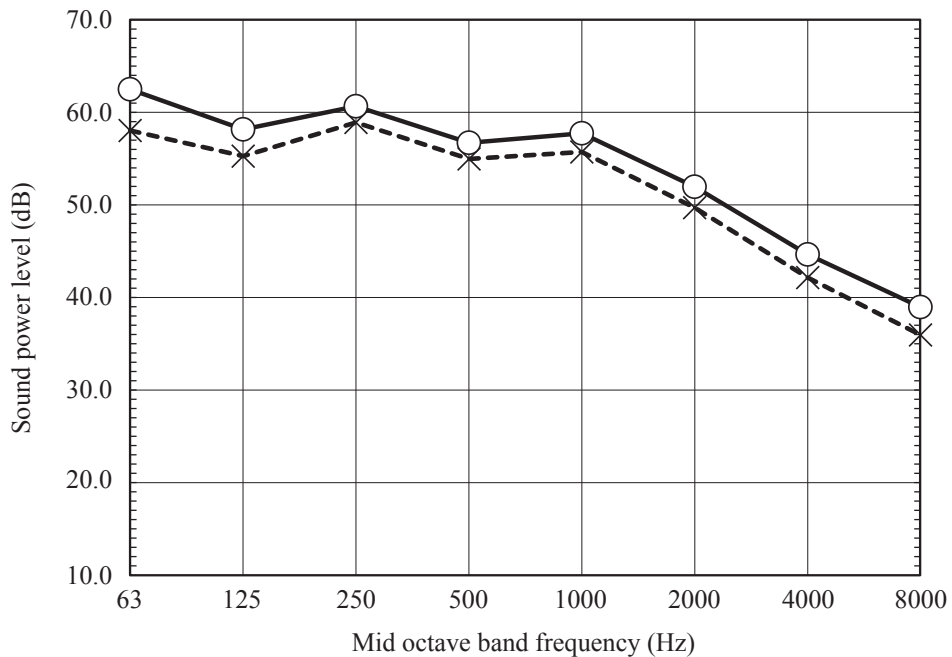

Model SRR60ZS-W
• Non duct

(Indoor unit)

Model	SRR60ZS-W	
Noise Level	Cooling	60 dB(A)
	Heating	63 dB(A)

Condition	ISO15042 T1/H1
-----------	----------------

MODE	Rated capacity value (Hi)
------	---------------------------



x Cooling, ○ — Heating

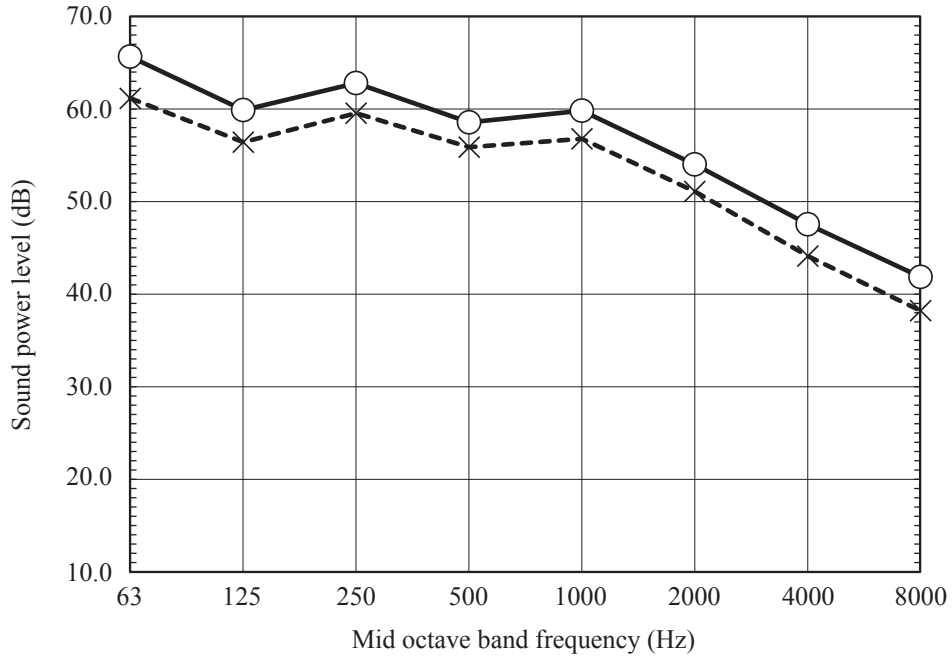

• With duct

(Indoor unit)

Model	SRR60ZS-W	
Noise Level	Cooling	60 dB(A)
	Heating	63 dB(A)

Condition	ISO15042 T1/H1
-----------	----------------

MODE	Rated capacity value (Hi)
------	---------------------------

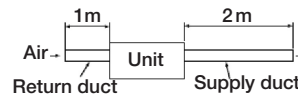

External static pressure : 10Pa

x Cooling, ○ — Heating

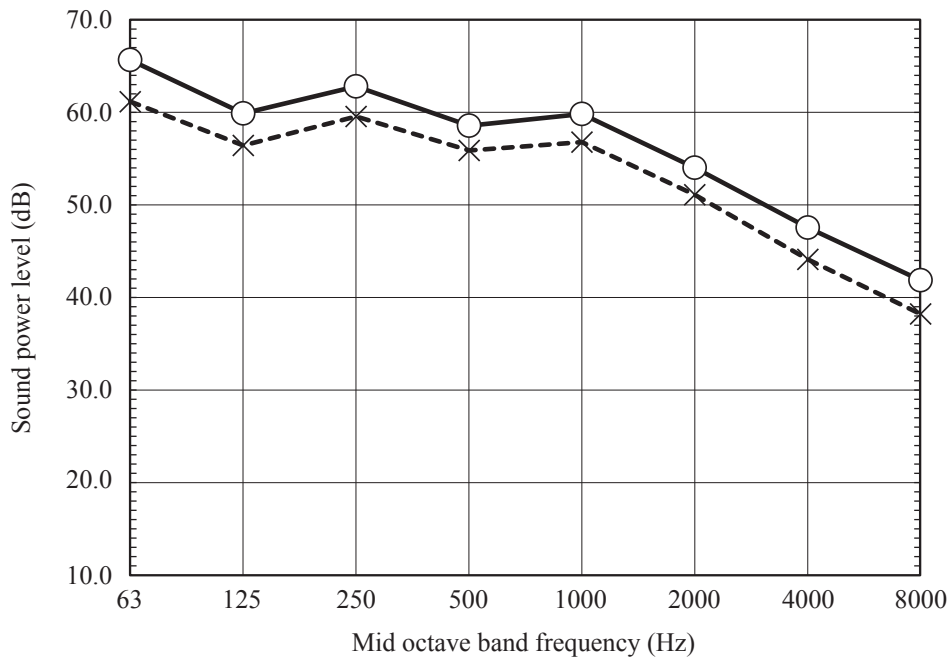

(ii) Sound pressure level

1) Rated capacity value (Hi)

Model SRR25ZS-W

● Sound pressure level ①

(Indoor unit)

Model	SRR25ZS-W	
Noise level	Cooling	37 dB(A)
	Heating	40 dB(A)

Condition	ISO15042 T1/H1
-----------	----------------

MODE	Hi
------	----

● Mike position

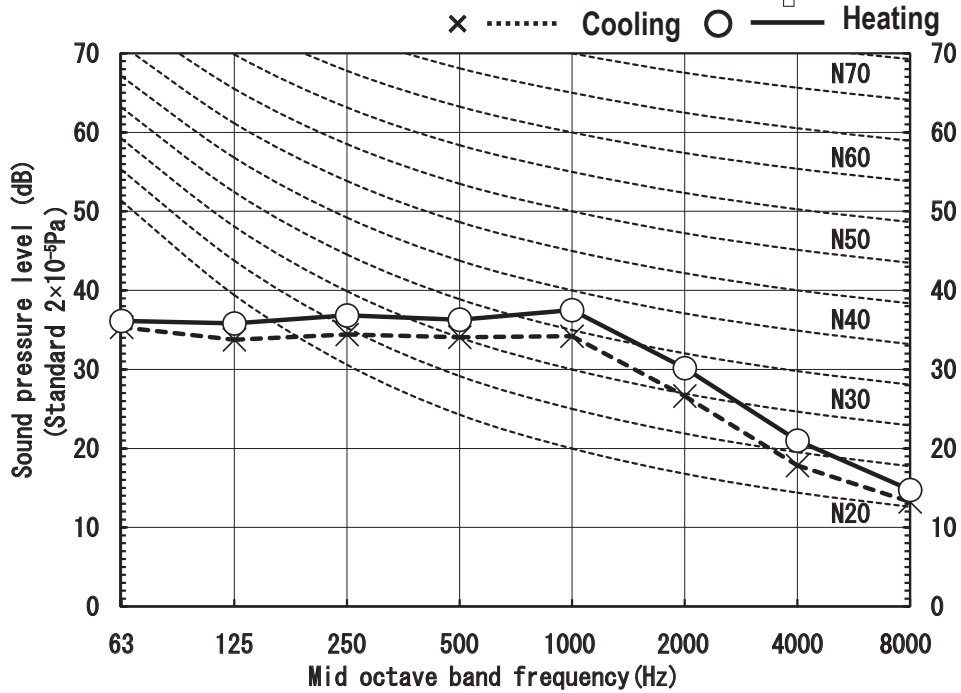
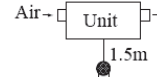

● Sound pressure level ②

(Indoor unit)

Model	SRR25ZS-W	
Noise level	Cooling	31 dB(A)
	Heating	33 dB(A)

Condition	ISO15042 T1/H1
-----------	----------------

MODE	Hi
------	----

● Mike position

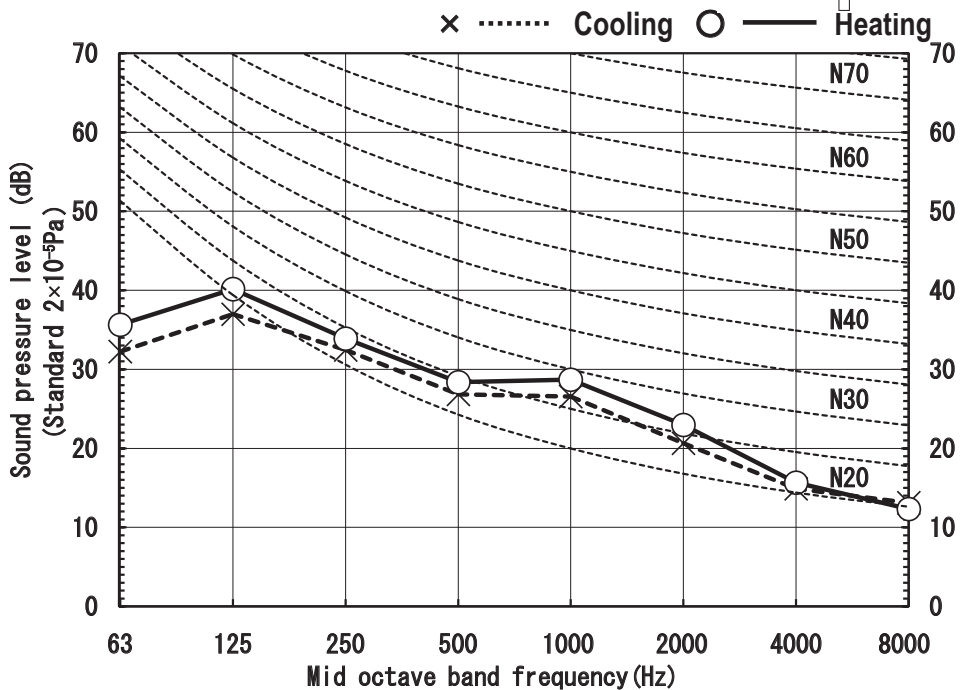
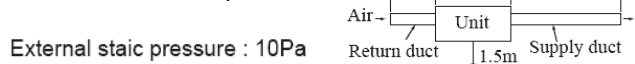

●Sound pressure level ③

Condition	ISO15042 T1/H1
-----------	----------------

(Indoor unit)

Model	SRR25ZS-W	
Noise level	Cooling	39 dB(A)
	Heating	44 dB(A)

MODE	Hi
------	----

●Mike position

External static pressure : 10Pa

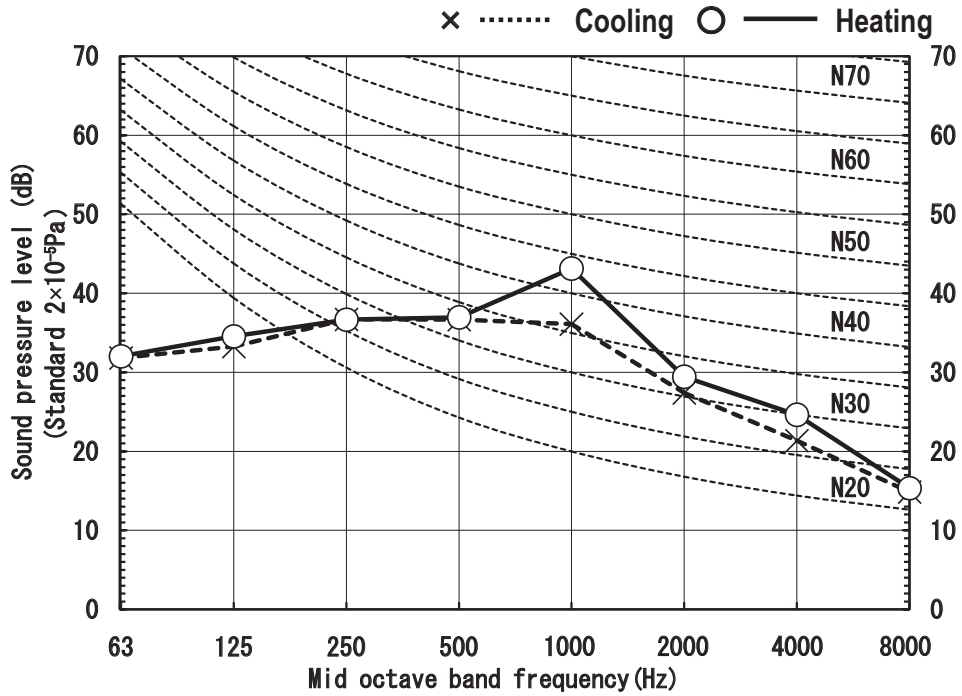
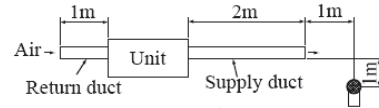

Model SRR35ZS-W

●Sound pressure level ①

(Indoor unit)

Model	SRR35ZS-W	
Noise level	Cooling	38 dB(A)
	Heating	42 dB(A)

Condition	ISO15042 T1/H1
-----------	----------------

MODE	Hi
------	----

●Mike position

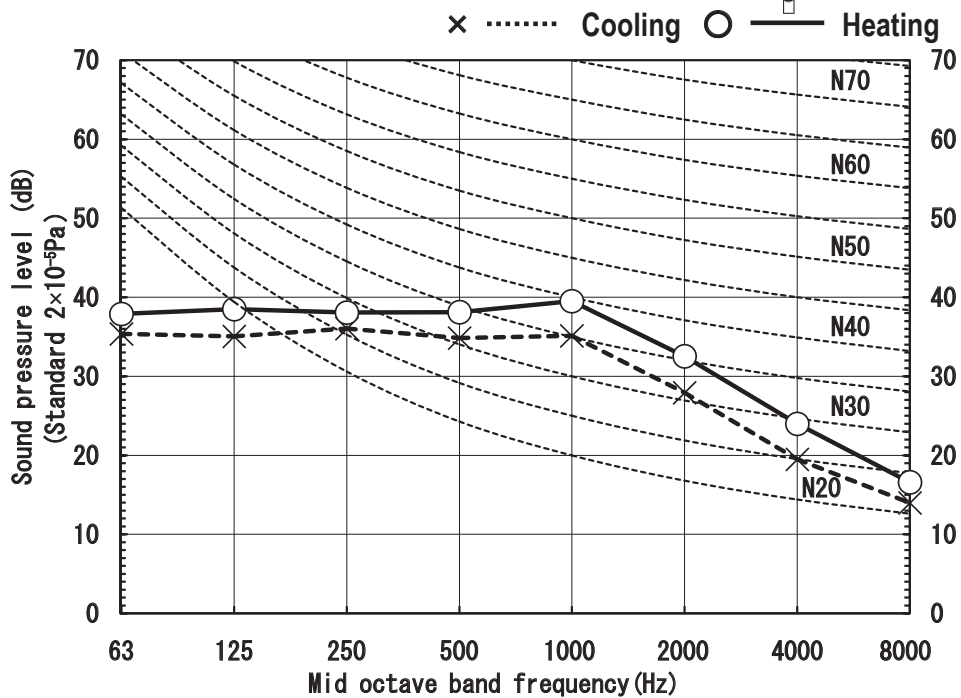
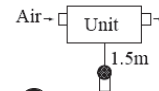

●Sound pressure level ②
(Indoor unit)

Model	SRR35ZS-W	
Noise level	Cooling	33 dB(A)
	Heating	34 dB(A)

Condition IS015042 T1/H1

MODE Hi

●Mike position

External static pressure : 10Pa

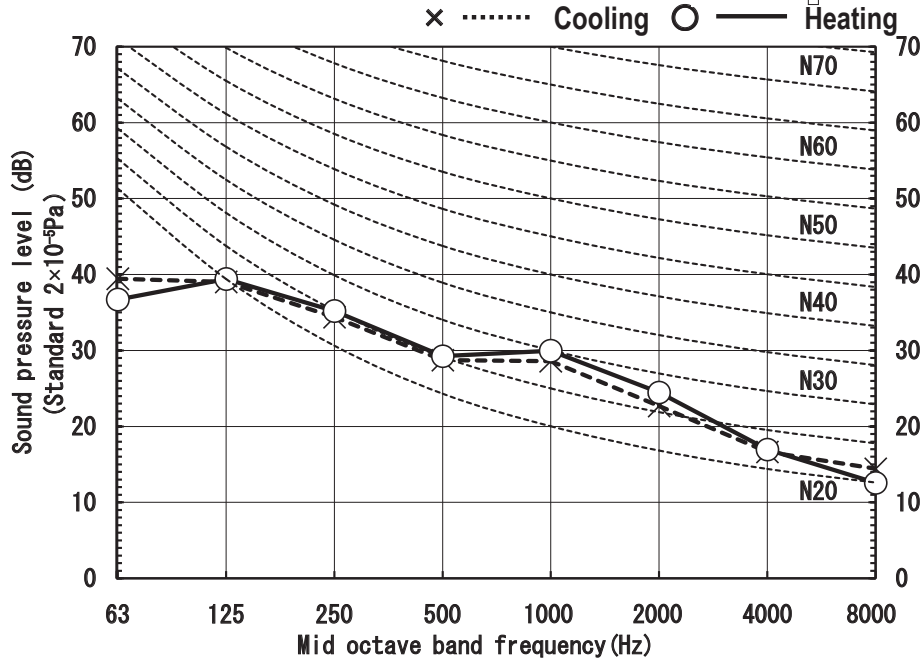
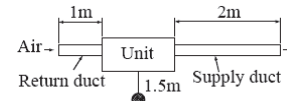

●Sound pressure level ③
(Indoor unit)

Model	SRR35ZS-W	
Noise level	Cooling	40 dB(A)
	Heating	45 dB(A)

Condition IS015042 T1/H1

MODE Hi

●Mike position

External static pressure : 10Pa

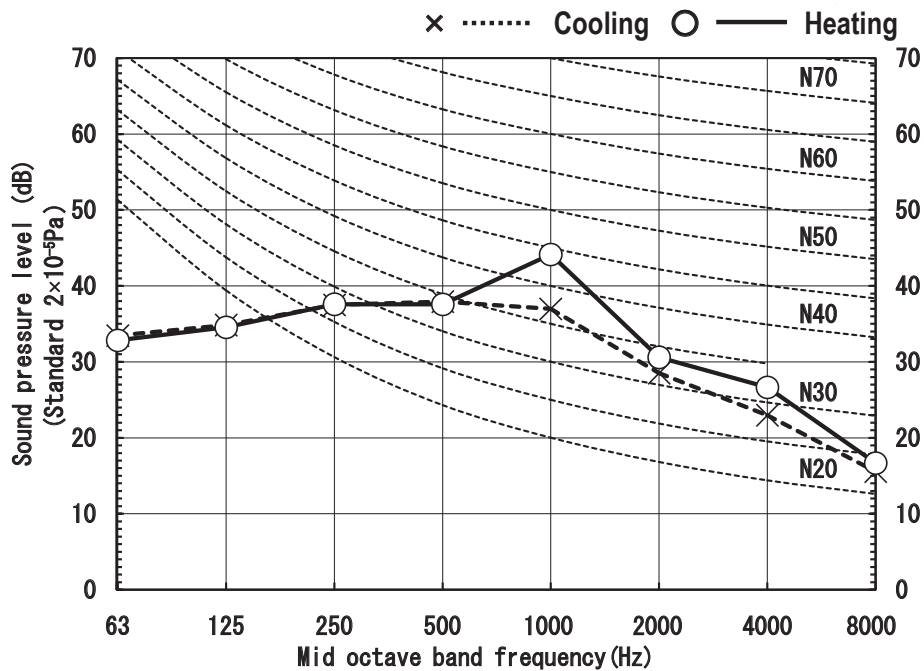
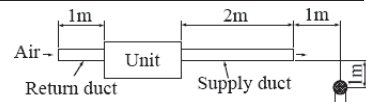

Model SRR50ZS-W

• Sound pressure level ①

(Indoor unit)

Model	SRR50ZS-W	
Noise	Cooling	41 dB(A)
Level	Heating	43 dB(A)

Condition	ISO15042 T1/H1
-----------	----------------

MODE	Rated capacity value (Hi)
------	---------------------------

● Mike position

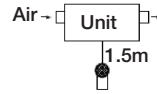

x Cooling, ○ — Heating

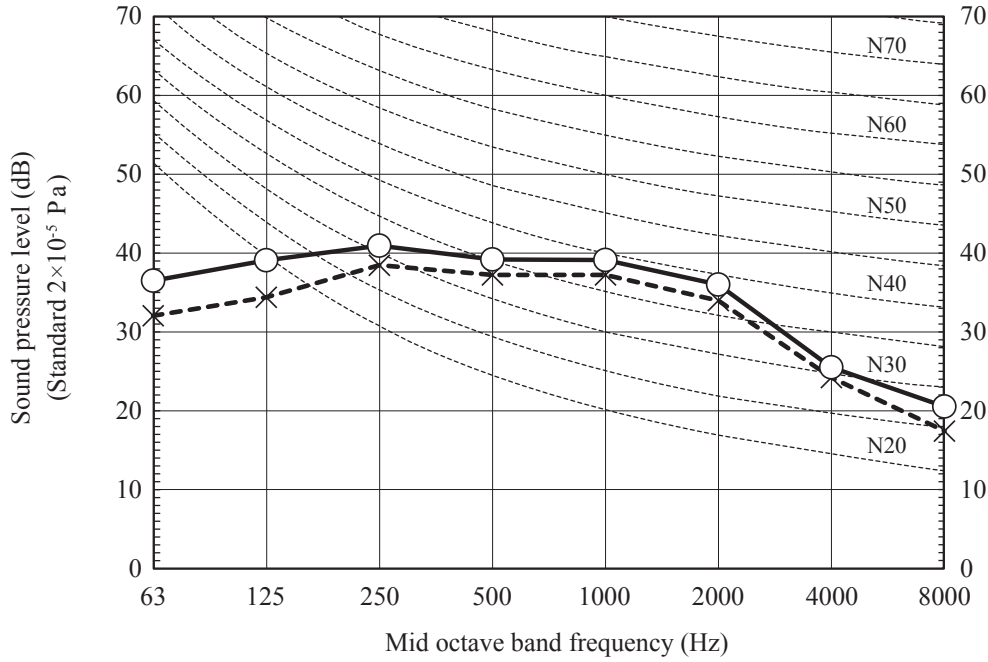

• Sound pressure level ②

(Indoor unit)

Model	SRR50ZS-W	
Noise	Cooling	35 dB(A)
Level	Heating	38 dB(A)

Condition	ISO15042 T1/H1
-----------	----------------

MODE	Rated capacity value (Hi)
------	---------------------------

● Mike position

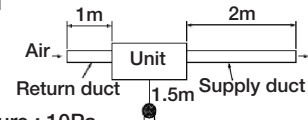

External static pressure : 10Pa

x Cooling, ○ — Heating

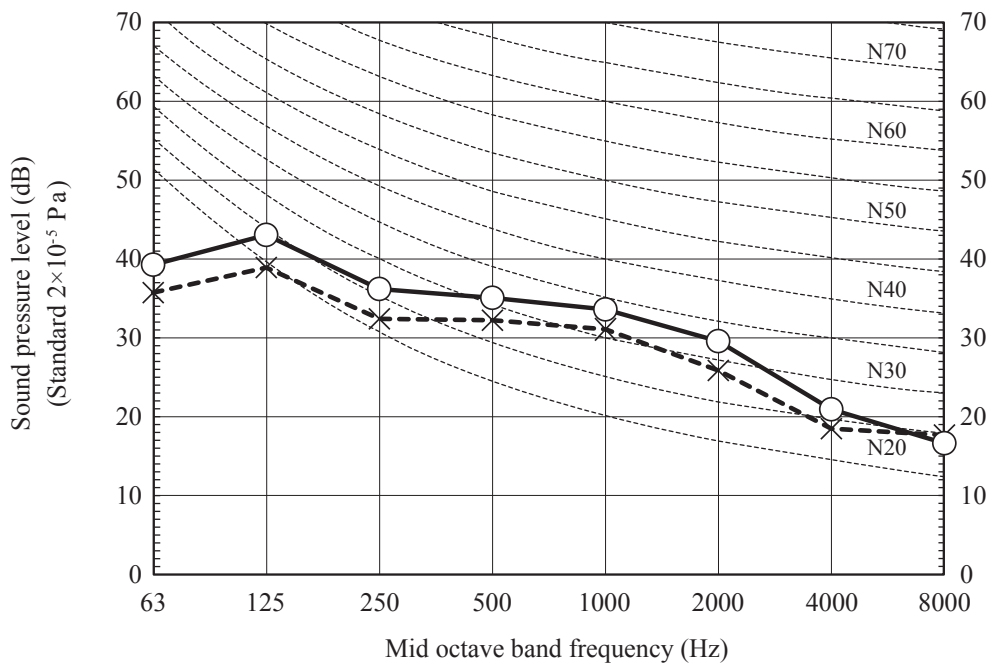

Model SRR60ZS-W

• Sound pressure level ①

(Indoor unit)

Model	SRR60ZS-W	
Noise	Cooling	44 dB(A)
Level	Heating	45 dB(A)

Condition	ISO15042 T1/H1
-----------	----------------

MODE	Rated capacity value (Hi)
------	---------------------------

• Mike position

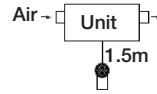

x Cooling, ○ — Heating

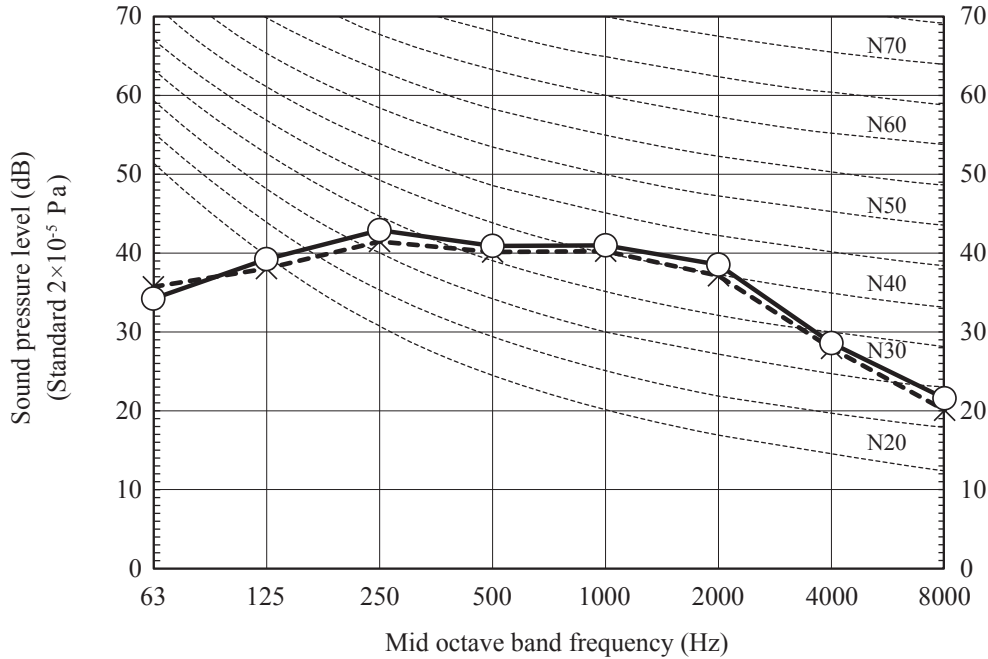

• Sound pressure level ②

(Indoor unit)

Model	SRR60ZS-W	
Noise	Cooling	37 dB(A)
Level	Heating	39 dB(A)

Condition	ISO15042 T1/H1
-----------	----------------

MODE	Rated capacity value (Hi)
------	---------------------------

• Mike position

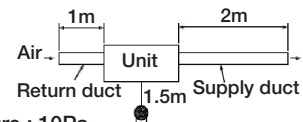

External static pressure : 10Pa

x Cooling, ○ — Heating

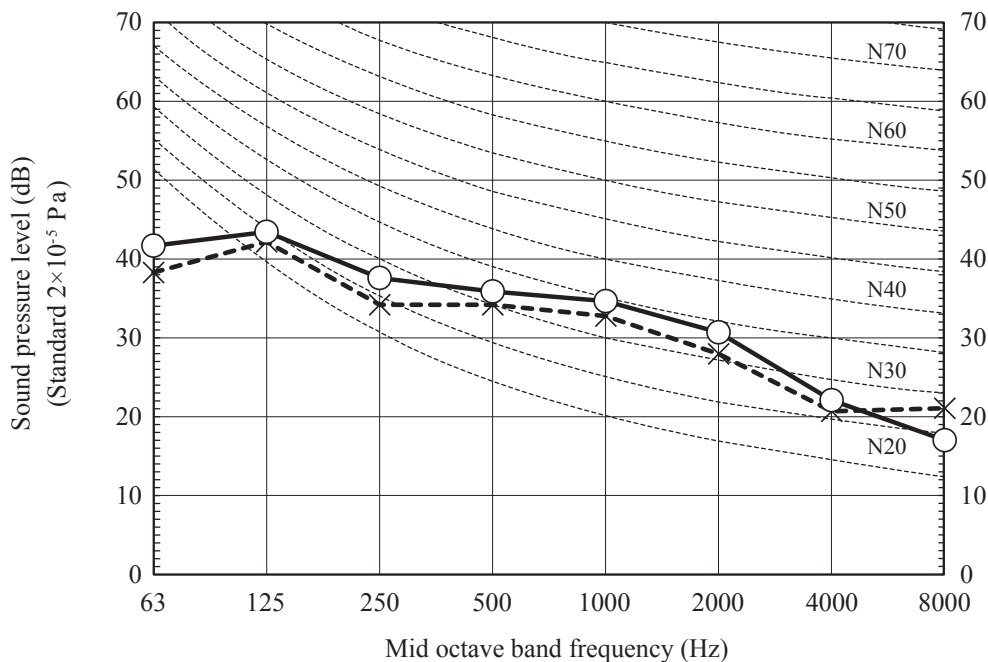

2) Each fan speed mode

Model SRR25ZS-W

● Sound pressure level ①

(Indoor unit)

Model	SRR25ZS-W	
Noise level	Cooling	33 dB(A)
	Heating	37 dB(A)

Condition	ISO15042 T1/H1
-----------	----------------

MODE	Me
------	----

● Mike position

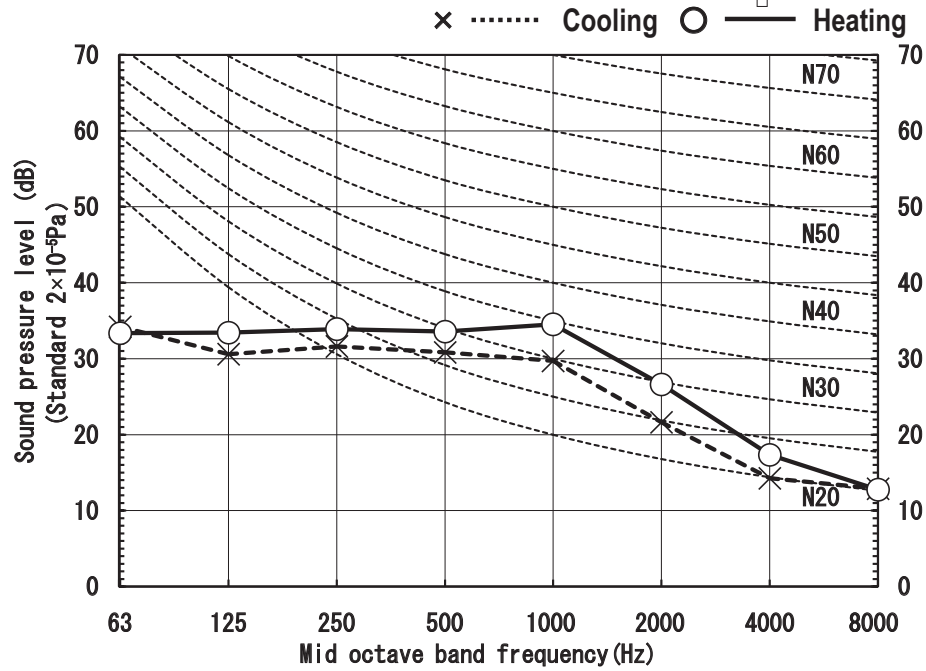
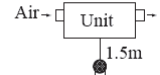

(Indoor unit)

Model	SRR25ZS-W	
Noise level	Cooling	30 dB(A)
	Heating	34 dB(A)

Condition	ISO15042 T1/H1
-----------	----------------

MODE	Lo
------	----

● Mike position

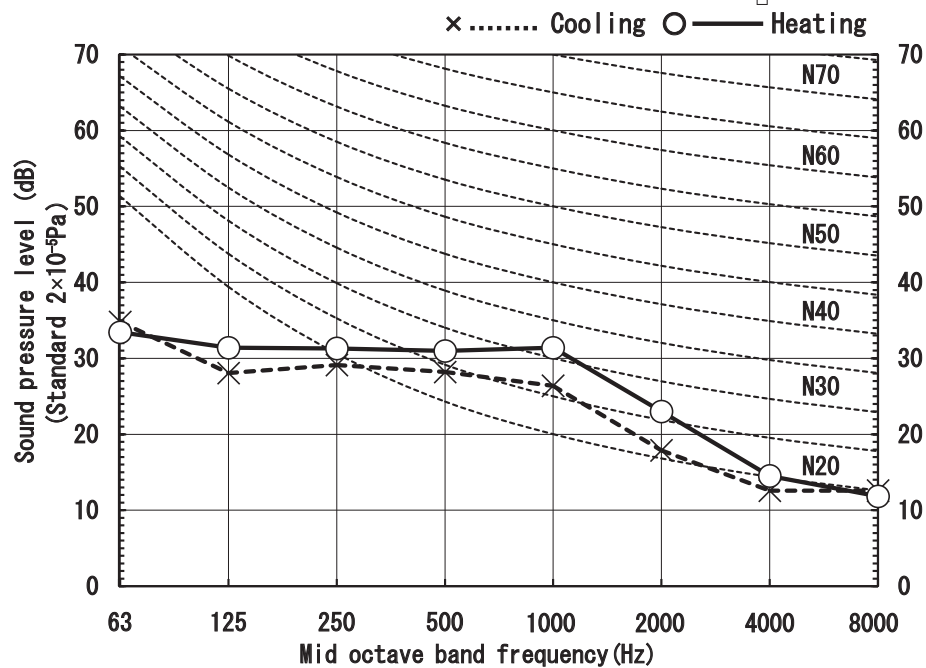
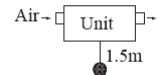

(Indoor unit)

Model	SRR25ZS-W	
Noise level	Cooling	24 dB(A)
	Heating	28 dB(A)

Condition	ISO15042 T1/H1
-----------	----------------

MODE	ULo
------	-----

● Mike position

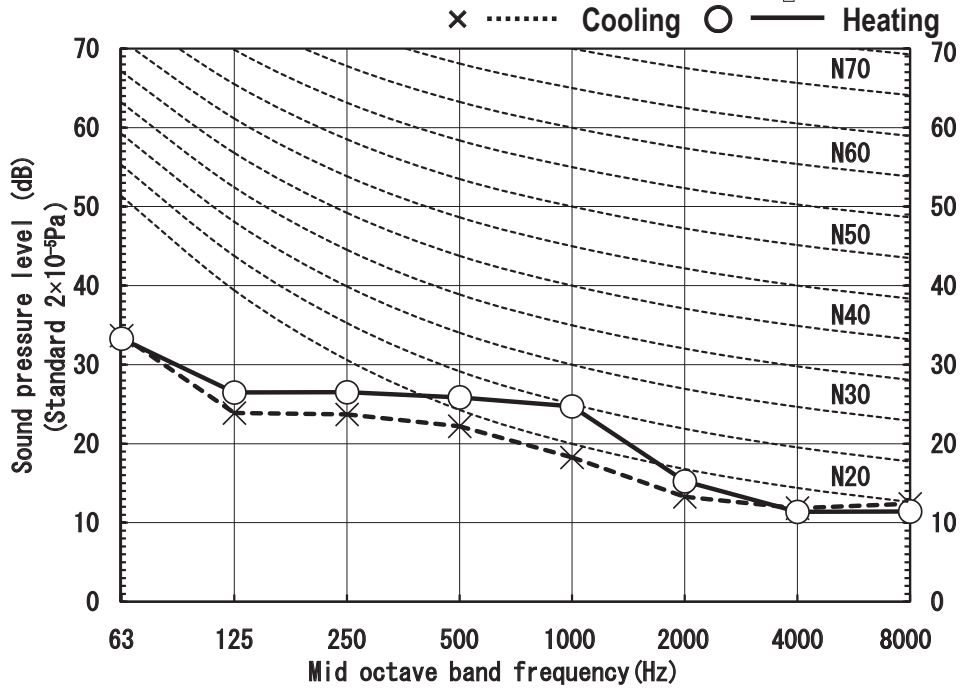
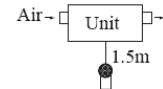

● Sound pressure level ②

(Indoor unit)

Model	SRR25ZS-W	
Noise level	Cooling	28 dB(A)
	Heating	30 dB(A)

Condition	ISO15042 T1/H1
-----------	----------------

MODE	Me
------	----

● Mike position

External static pressure : 10Pa

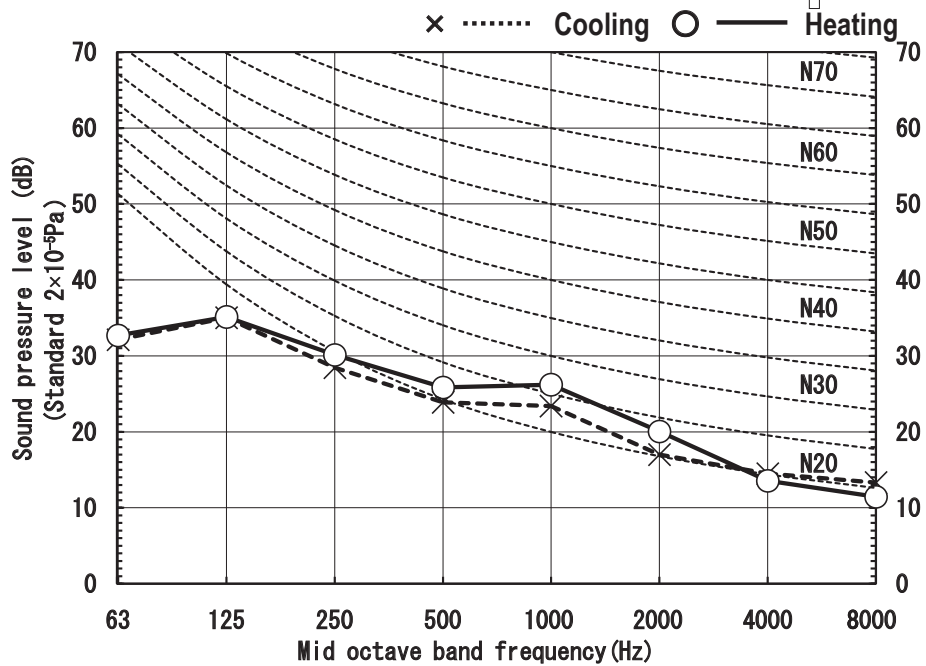
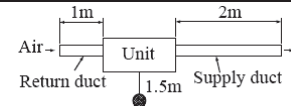

(Indoor unit)

Model	SRR25ZS-W	
Noise level	Cooling	26 dB(A)
	Heating	28 dB(A)

Condition	ISO15042 T1/H1
-----------	----------------

MODE	Lo
------	----

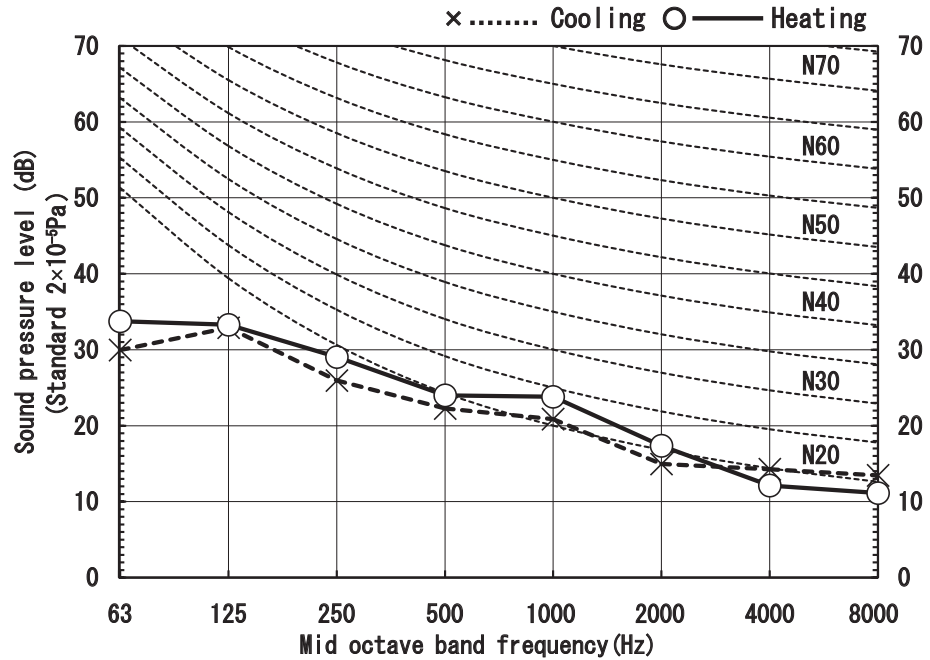
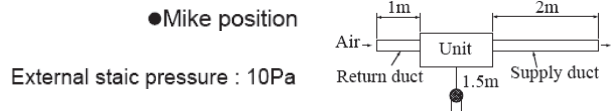

(Indoor unit)

Model	SRR25ZS-W	
Noise level	Cooling	21 dB(A)
	Heating	23 dB(A)

Condition	ISO15042 T1/H1
-----------	----------------

MODE	ULo
------	-----

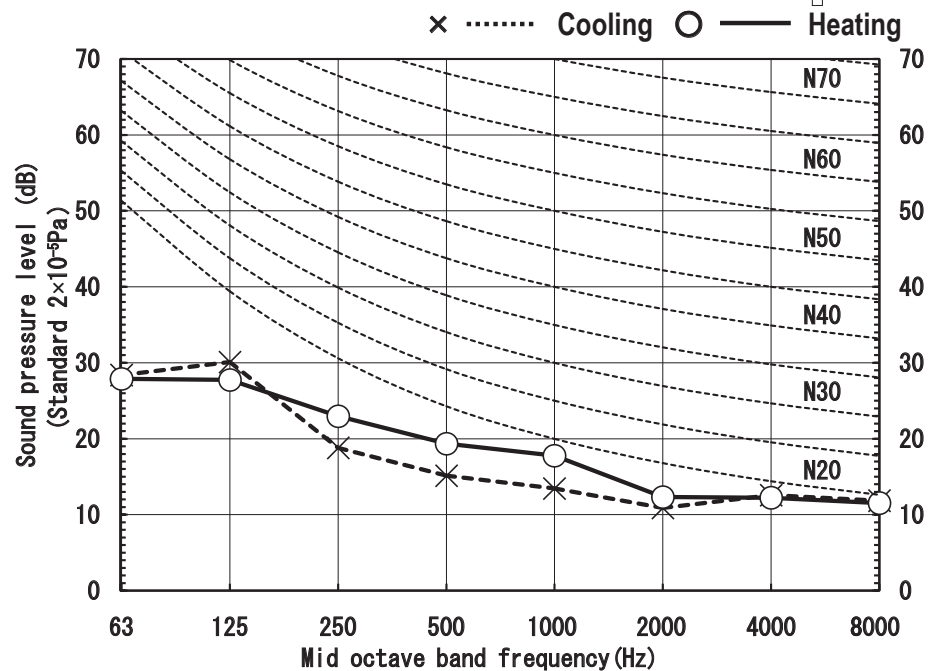
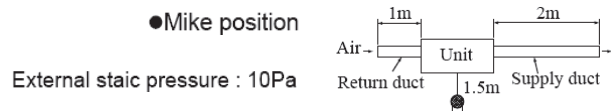

● Sound pressure level ③

(Indoor unit)

Model	SRR25ZS-W	
Noise level	Cooling	35 dB(A)
	Heating	41 dB(A)

Condition ISO15042 T1/H1

MODE Me

● Mike position

External static pressure : 10Pa

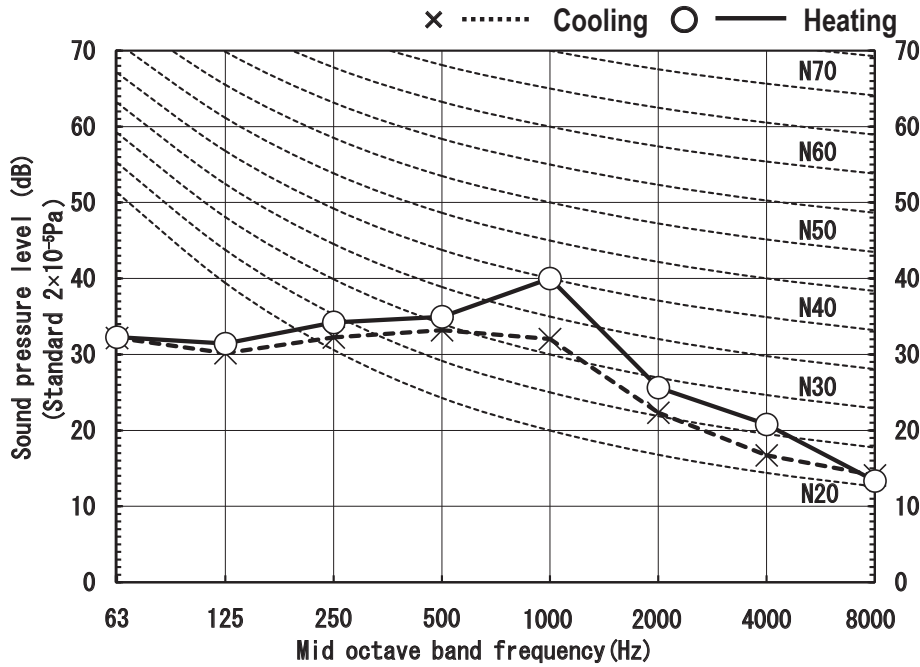
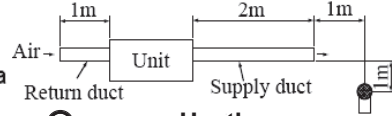

(Indoor unit)

Model	SRR25ZS-W	
Noise level	Cooling	32 dB(A)
	Heating	38 dB(A)

Condition ISO15042 T1/H1

MODE Lo

● Mike position

External static pressure : 10Pa

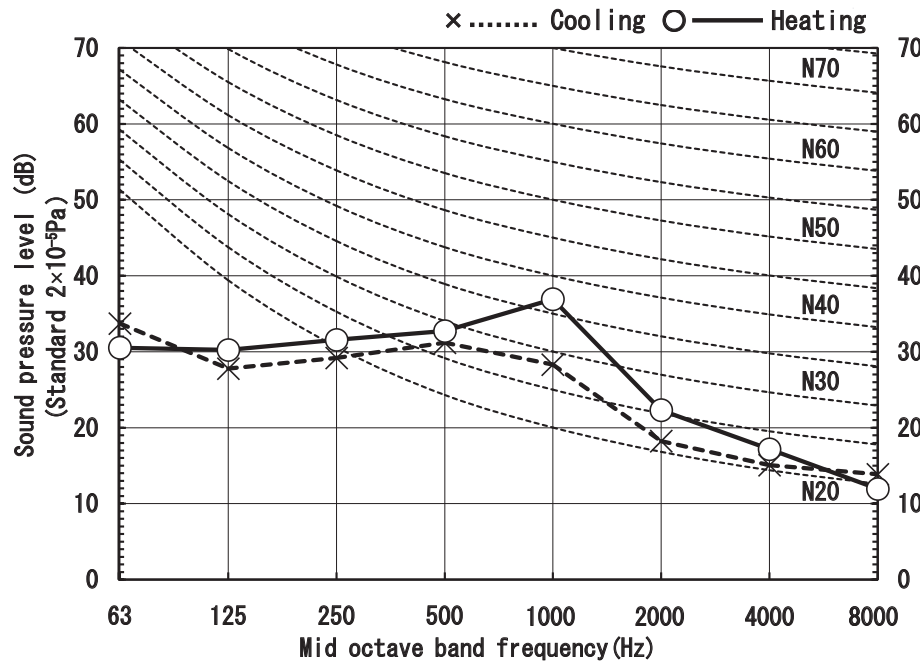
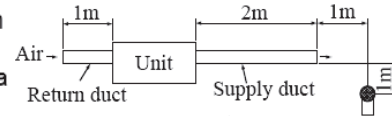

(Indoor unit)

Model	SRR25ZS-W	
Noise level	Cooling	25 dB(A)
	Heating	31 dB(A)

External static pressure : 10Pa

Condition	ISO15042 T1/H1
-----------	----------------

MODE	ULo
------	-----

●Mike position

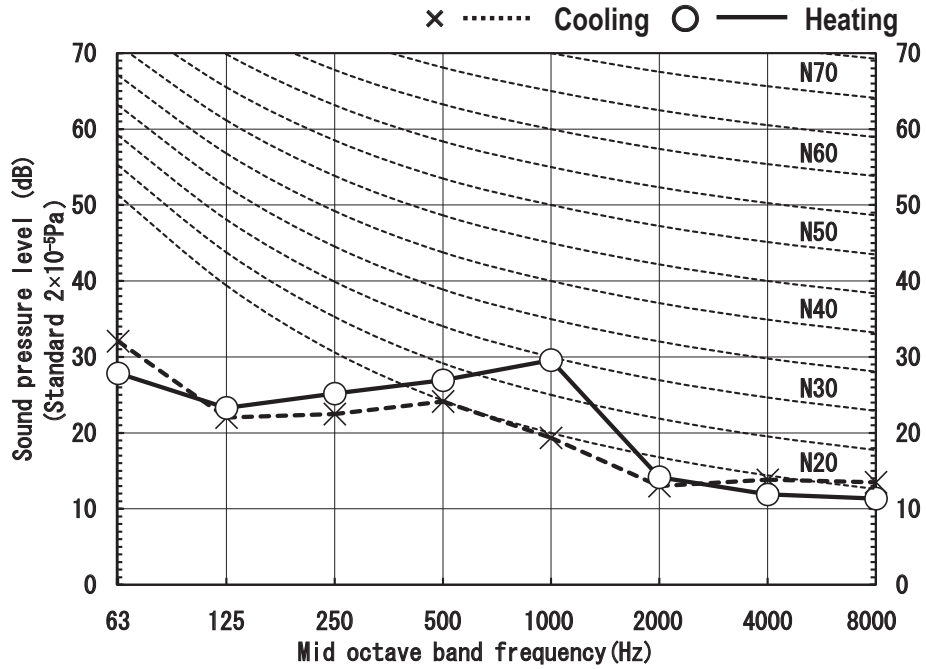
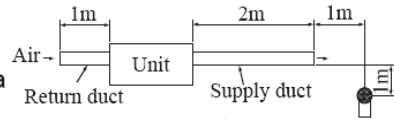

Model SRR35ZS-W

●Sound pressure level ①

(Indoor unit)

Model	SRR35ZS-W	
Noise level	Cooling	34 dB(A)
	Heating	38 dB(A)

Condition	ISO15042 T1/H1
-----------	----------------

MODE	Me
------	----

●Mike position

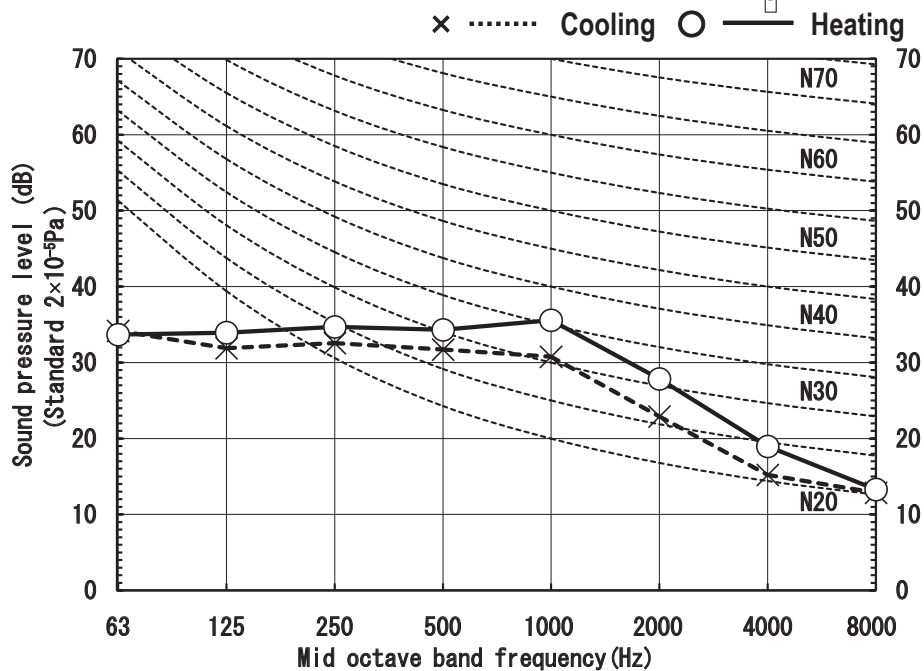
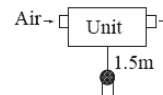

(Indoor unit)

Model	SRR35ZS-W	
Noise level	Cooling	31 dB(A)
	Heating	35 dB(A)

Condition	ISO15042 T1/H1
-----------	----------------

MODE	Lo
------	----

● Mike position

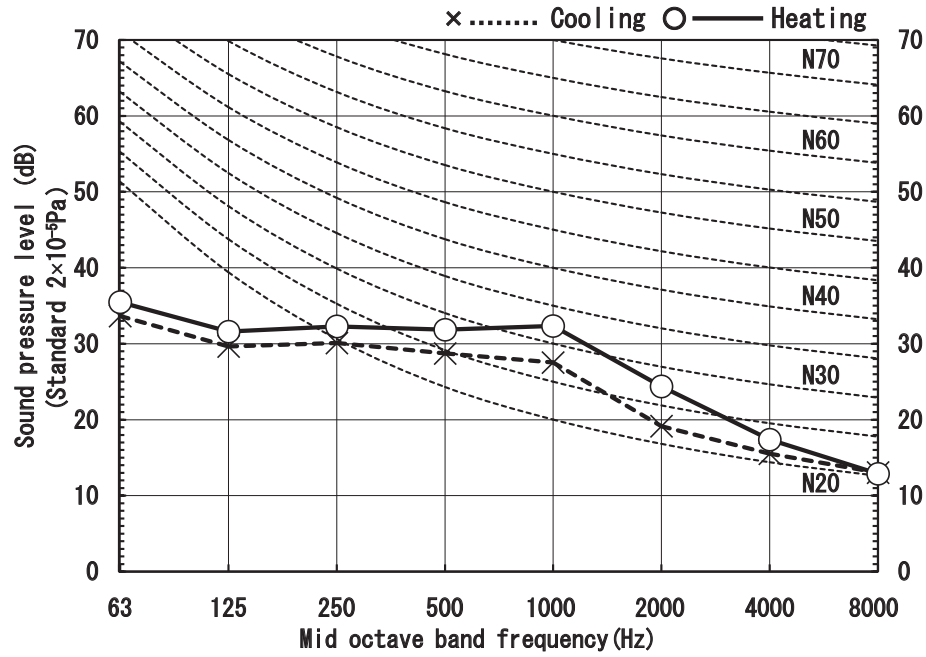
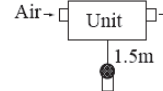

Condition	ISO15042 T1/H1
-----------	----------------

MODE	ULo
------	-----

● Mike position

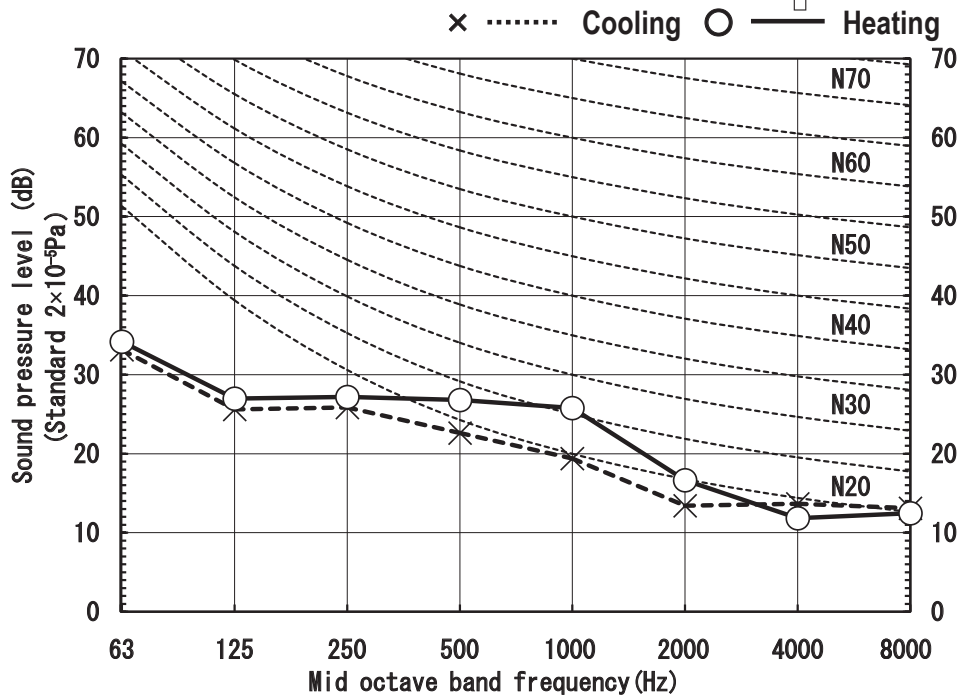
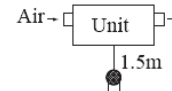

(Indoor unit)

Model	SRR35ZS-W	
Noise level	Cooling	25 dB(A)
	Heating	29 dB(A)

● Sound pressure level ②

(Indoor unit)

Model	SRR35ZS-W	
Noise level	Cooling	30 dB(A)
	Heating	32 dB(A)

Condition	ISO15042 T1/H1
-----------	----------------

MODE	Me
------	----

● Mike position

External static pressure : 10Pa

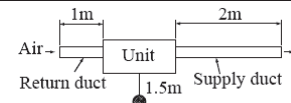

× Cooling ○ — Heating

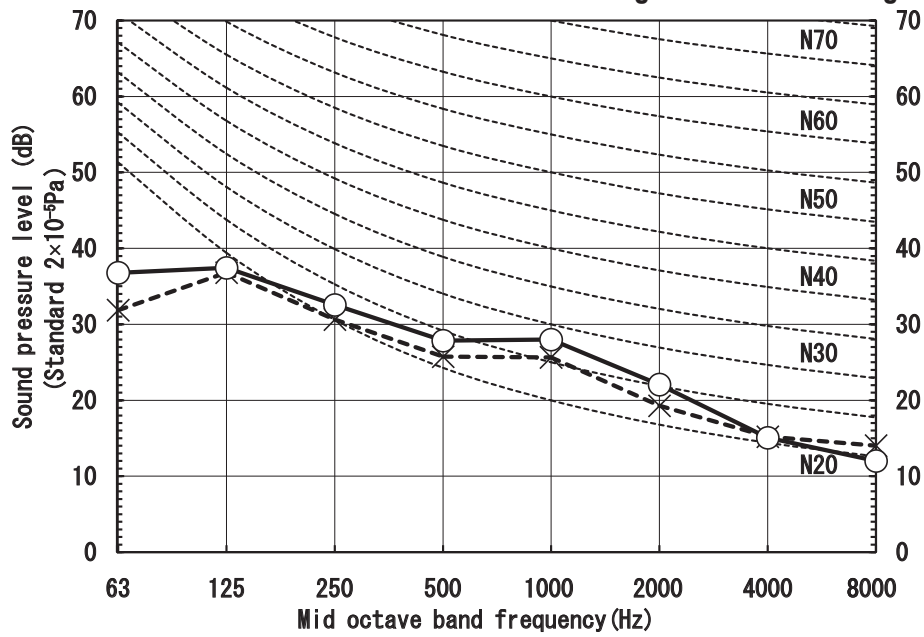

(Indoor unit)

Model	SRR35ZS-W	
Noise level	Cooling	27 dB(A)
	Heating	29 dB(A)

Condition	ISO15042 T1/H1
-----------	----------------

MODE	Lo
------	----

● Mike position

External static pressure : 10Pa

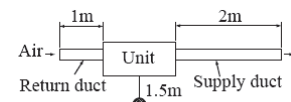

× Cooling ○ — Heating

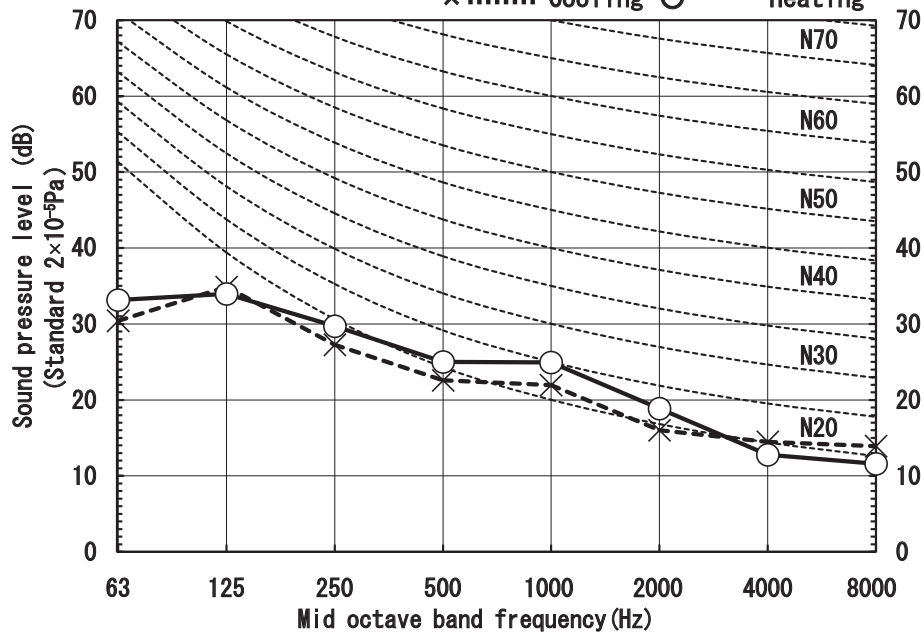

(Indoor unit)

Model	SRR35ZS-W	
Noise level	Cooling	22 dB(A)
	Heating	24 dB(A)

Condition: ISO15042 T1/H1

MODE: UL0

● Mike position

External static pressure : 10Pa

× Cooling ○ — Heating

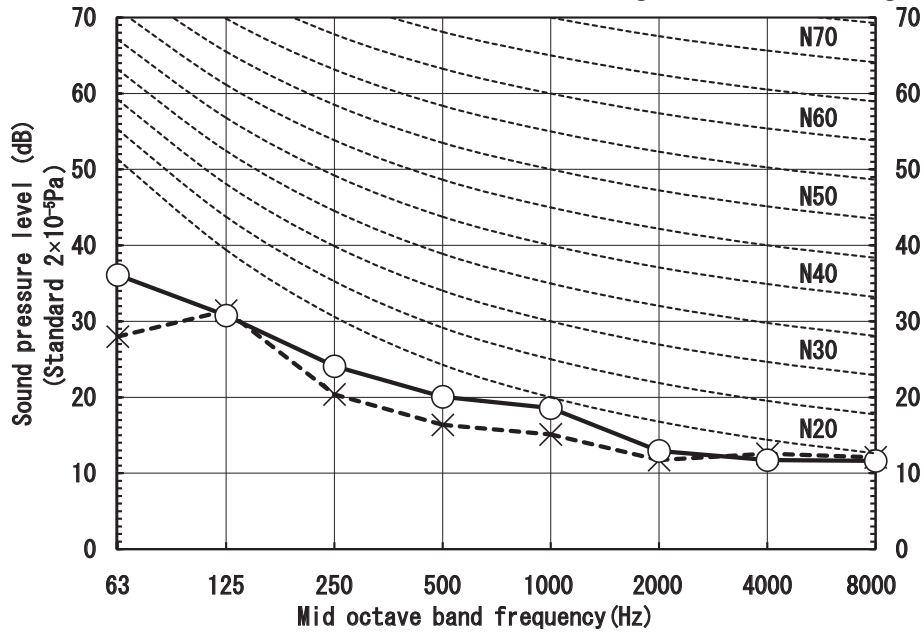

● Sound pressure level ③

(Indoor unit)

Model	SRR35ZS-W	
Noise level	Cooling	37 dB(A)
	Heating	42 dB(A)

Condition: ISO15042 T1/H1

MODE: Me

● Mike position

External static pressure : 10Pa

× Cooling ○ — Heating

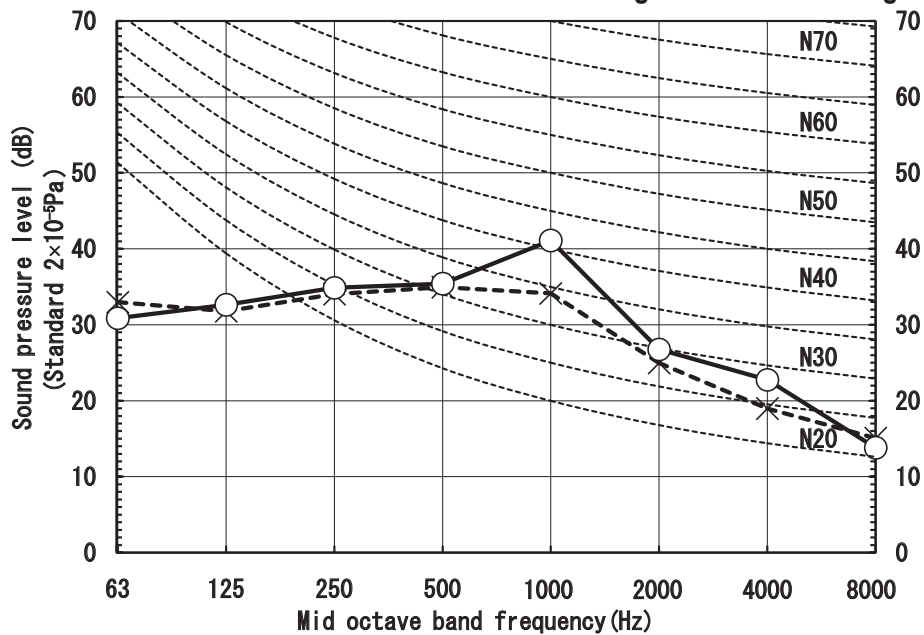

(Indoor unit)		
Model	SRR35ZS-W	
Noise level	Cooling	33 dB(A)
	Heating	39 dB(A)

Condition	IS015042 T1/H1
MODE	Lo

● Mike position

External static pressure : 10Pa

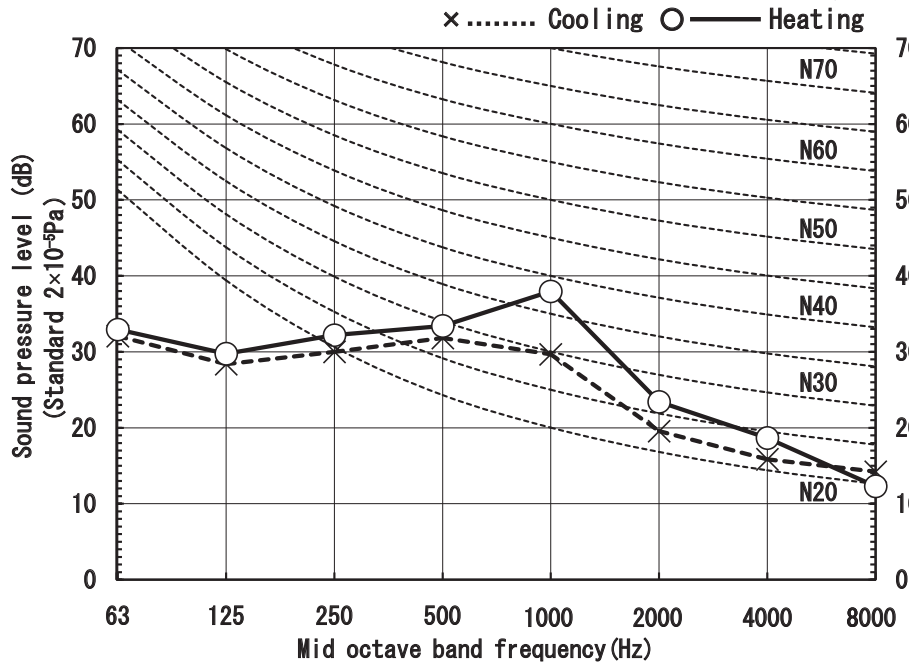

(Indoor unit)		
Model	SRR35ZS-W	
Noise level	Cooling	27 dB(A)
	Heating	33 dB(A)

Condition	IS015042 T1/H1
MODE	ULo

● Mike position

External static pressure : 10Pa

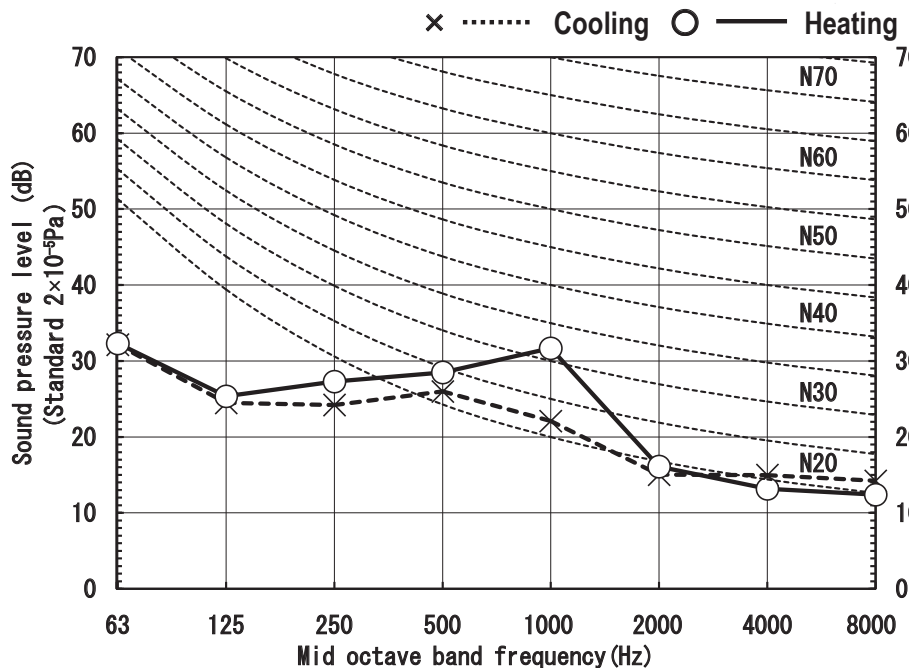

Model SRR50ZS-W
 • Sound pressure level ①

(Indoor unit)

Model	SRR50ZS-W	
Noise	Cooling	37 dB(A)
Level	Heating	39 dB(A)

Condition	ISO15042 T1/H1
-----------	----------------

MODE	Me
------	----

● Mike position

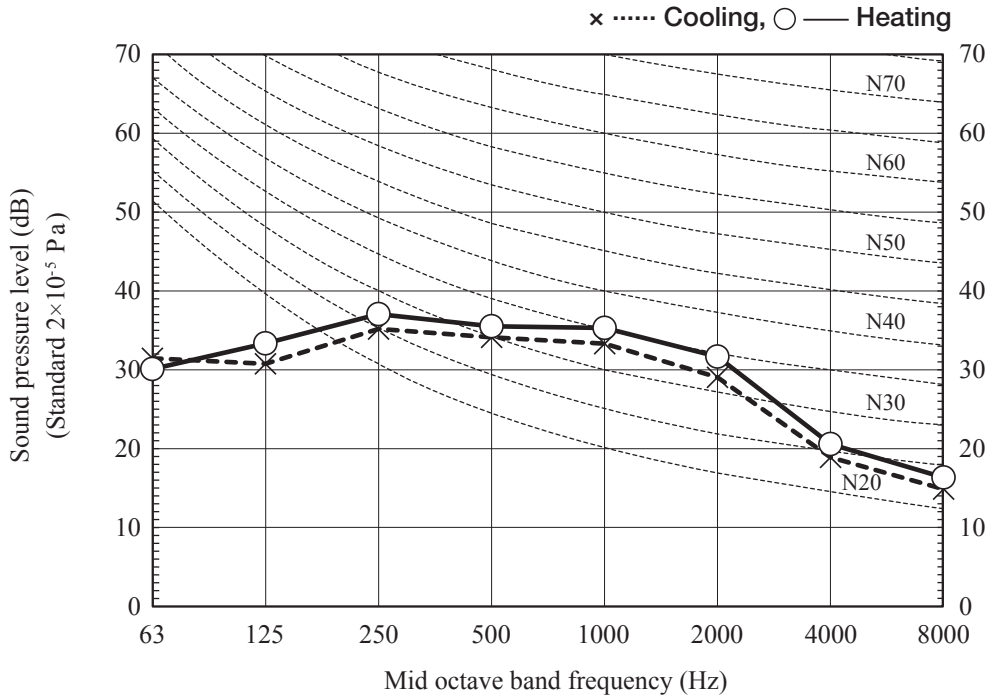
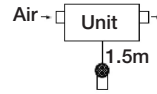

(Indoor unit)

Model	SRR50ZS-W	
Noise	Cooling	34 dB(A)
Level	Heating	37 dB(A)

Condition	ISO15042 T1/H1
-----------	----------------

MODE	Lo
------	----

● Mike position

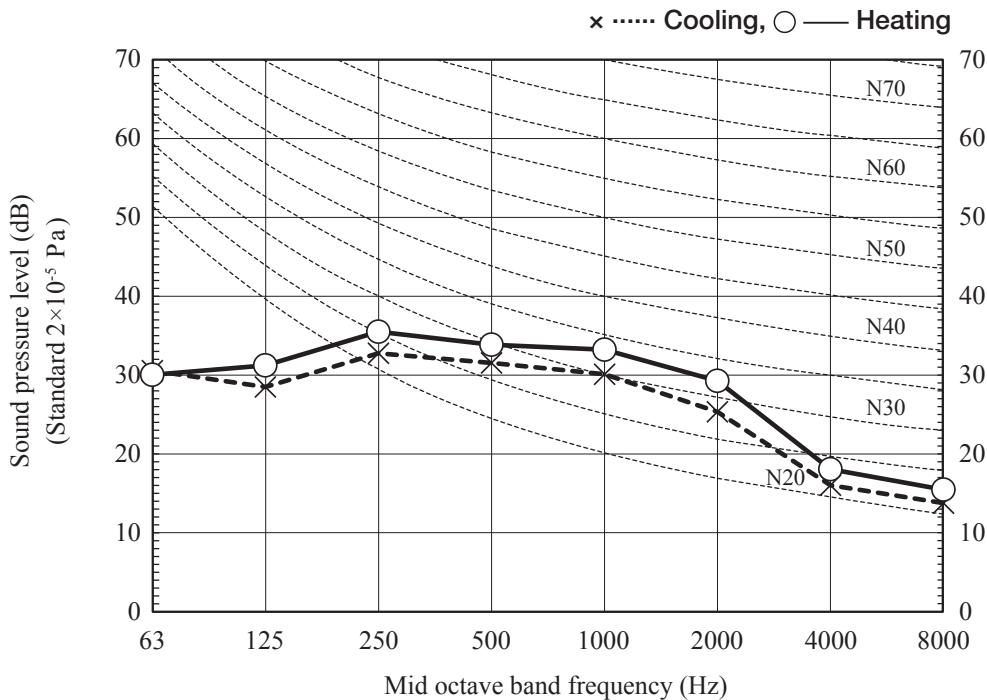
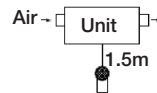

(Indoor unit)

Model	SRR50ZS-W	
Noise Level	Cooling	29 dB(A)
	Heating	32 dB(A)

Condition	ISO15042 T1/H1
-----------	----------------

MODE	ULo
------	-----

● Mike position

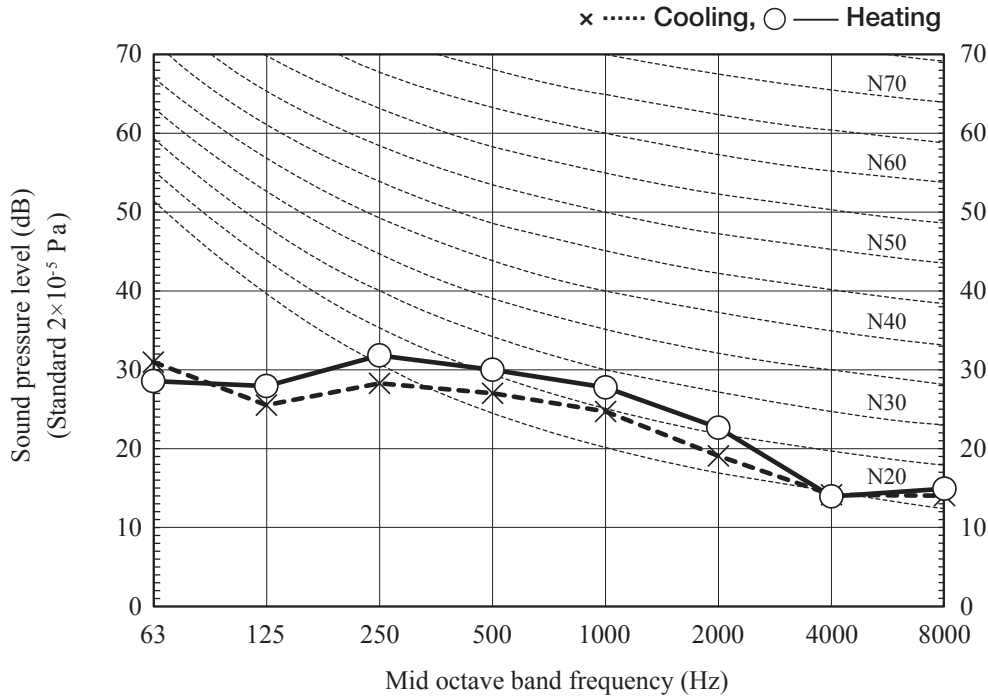
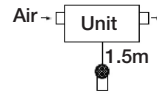

● Sound pressure level ②

(Indoor unit)

Model	SRR50ZS-W	
Noise Level	Cooling	33 dB(A)
	Heating	36 dB(A)

Condition	ISO15042 T1/H1
-----------	----------------

MODE	Me
------	----

● Mike position

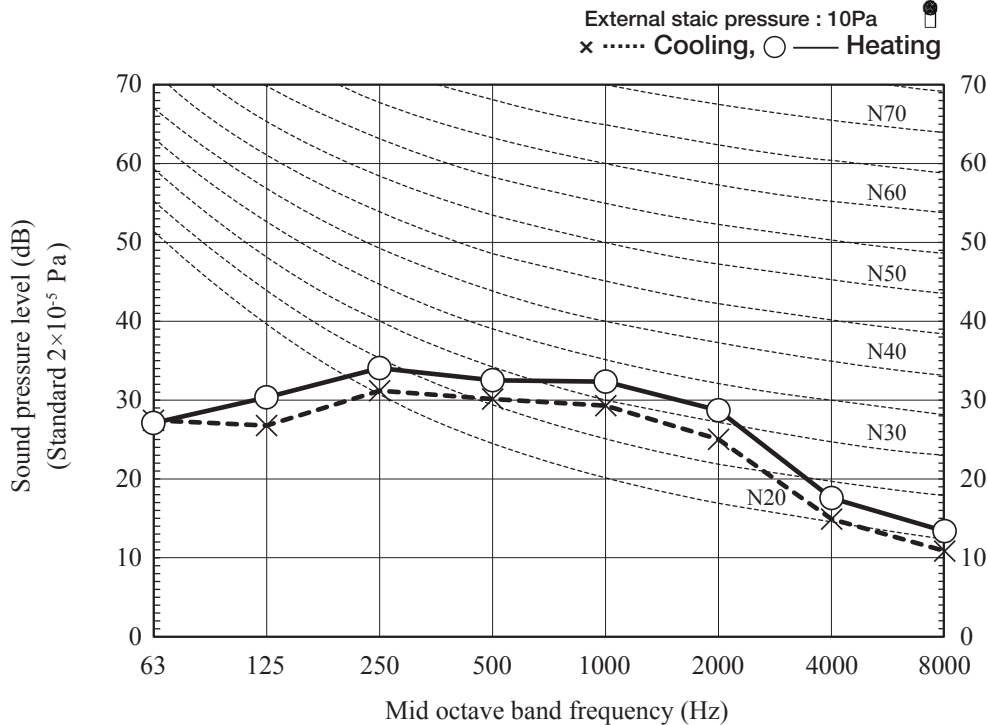
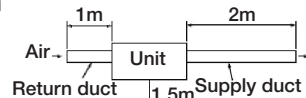

(Indoor unit)

Model	SRR50ZS-W	
Noise Level	Cooling	30 dB(A)
	Heating	33 dB(A)

Condition	ISO15042 T1/H1
-----------	----------------

MODE	Lo
------	----

● Mike position

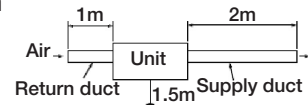

External static pressure : 10Pa

x Cooling, ○ — Heating

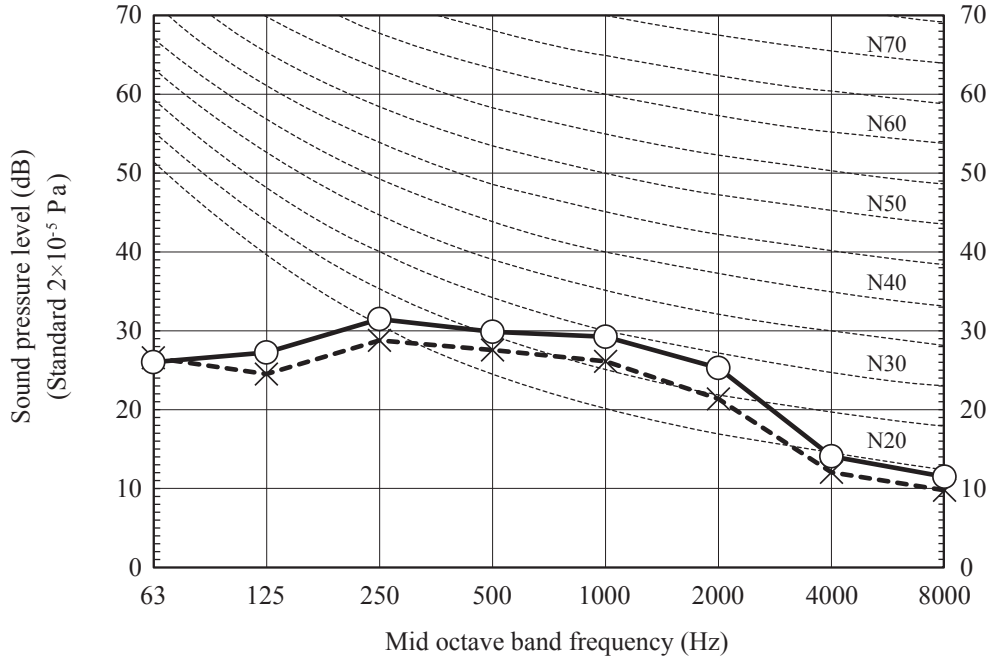

(Indoor unit)

Model	SRR50ZS-W	
Noise Level	Cooling	25 dB(A)
	Heating	28 dB(A)

Condition	ISO15042 T1/H1
-----------	----------------

MODE	ULo
------	-----

● Mike position

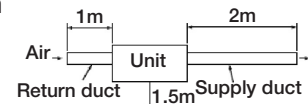

External static pressure : 10Pa

x Cooling, ○ — Heating

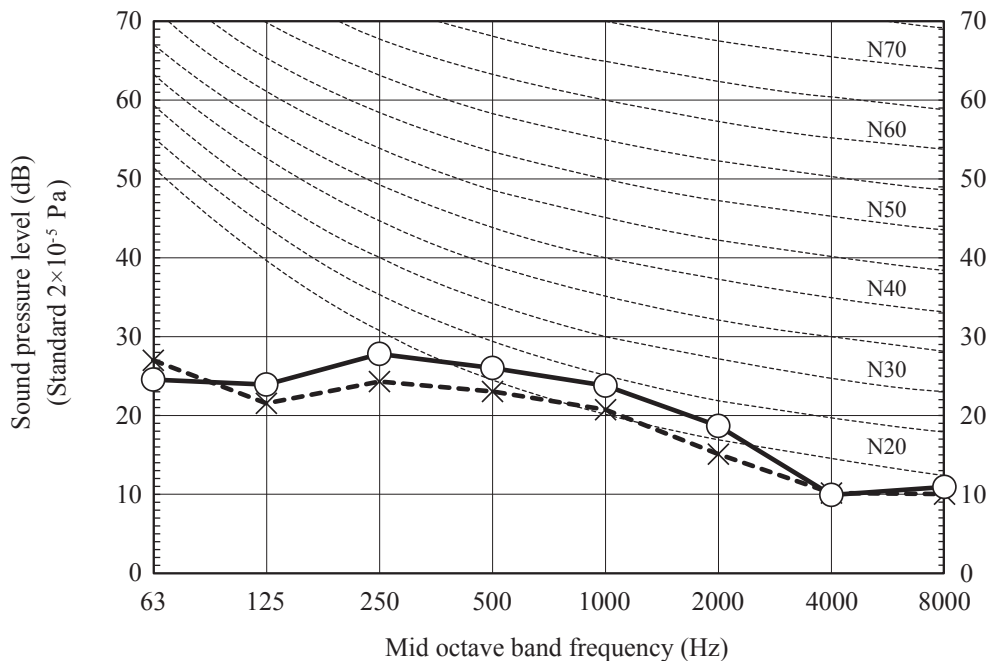

Model SRR60ZS-W
 • Sound pressure level ①

(Indoor unit)

Model	SRR60ZS-W	
Noise	Cooling	38 dB(A)
Level	Heating	41 dB(A)

Condition	ISO15042 T1/H1
-----------	----------------

MODE	Me
------	----

● Mike position

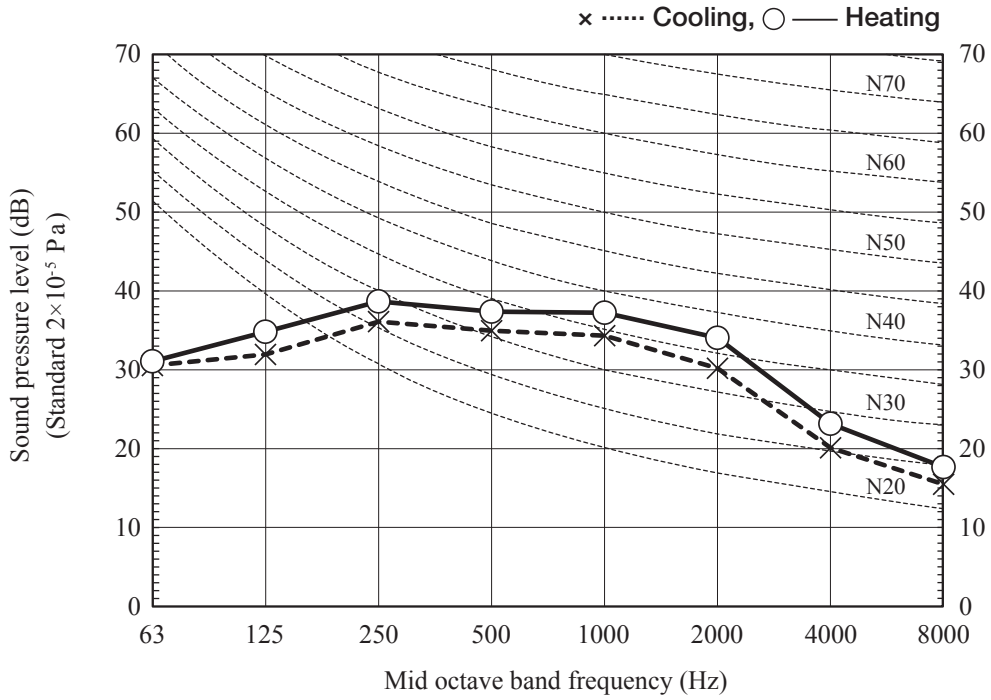
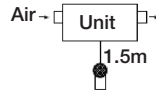

(Indoor unit)

Model	SRR60ZS-W	
Noise	Cooling	35 dB(A)
Level	Heating	38 dB(A)

Condition	ISO15042 T1/H1
-----------	----------------

MODE	Lo
------	----

● Mike position

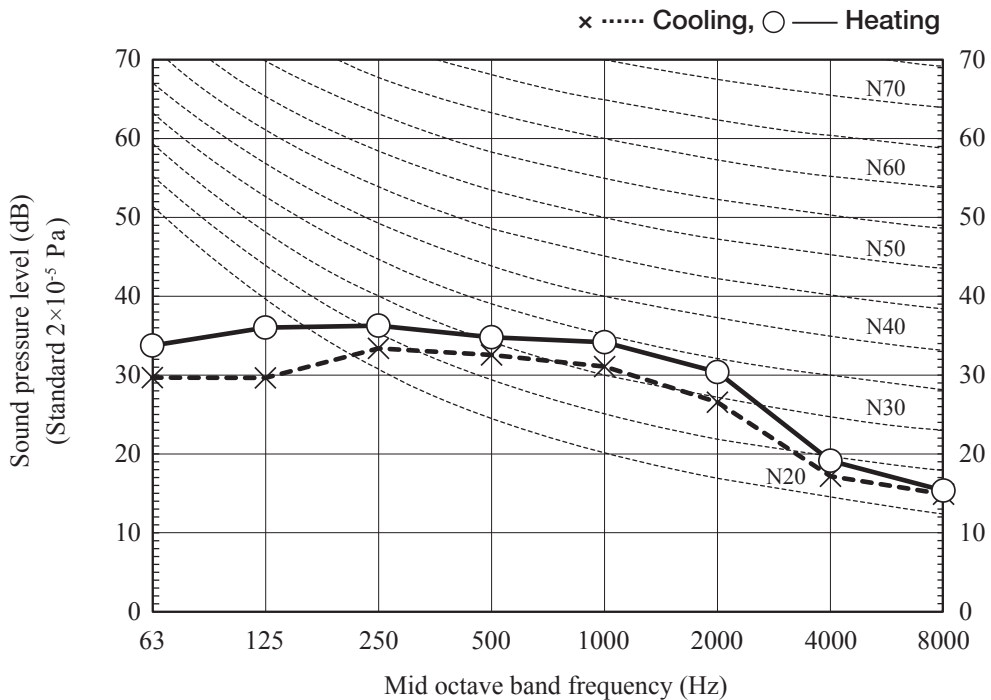
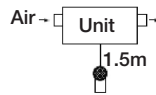

(Indoor unit)

Model	SRR60ZS-W	
Noise Level	Cooling	30 dB(A)
	Heating	33 dB(A)

Condition	ISO15042 T1/H1
-----------	----------------

MODE	ULo
------	-----

● Mike position

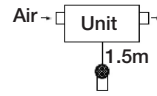

× Cooling, ○ — Heating

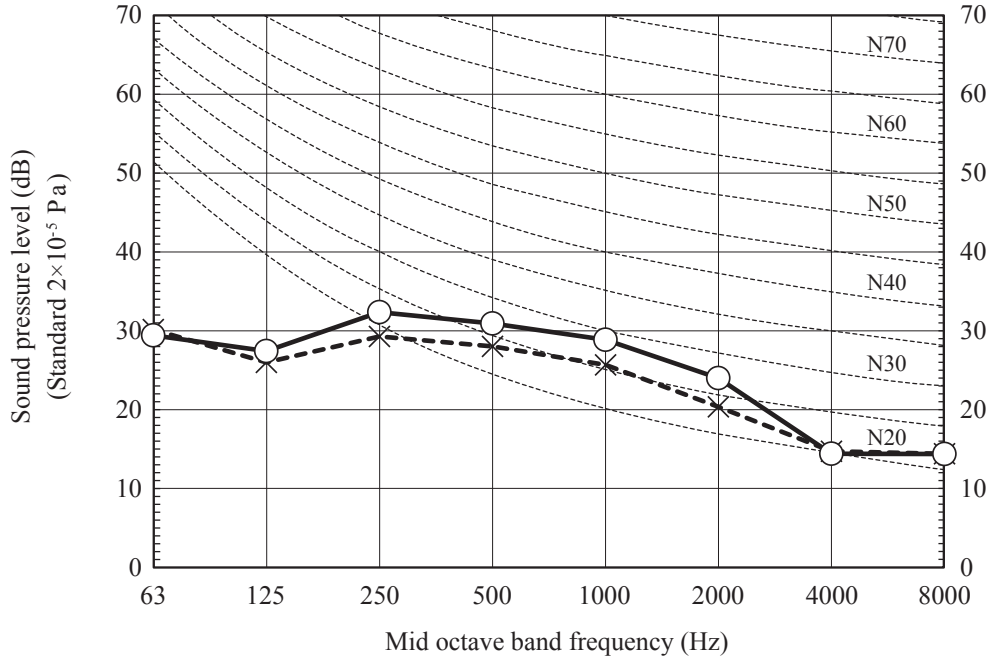

● Sound pressure level ②

(Indoor unit)

Model	SRR60ZS-W	
Noise Level	Cooling	34 dB(A)
	Heating	37 dB(A)

Condition	ISO15042 T1/H1
-----------	----------------

MODE	Me
------	----

● Mike position

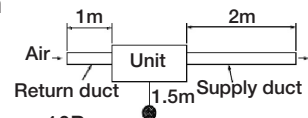

External static pressure : 10Pa

× Cooling, ○ — Heating

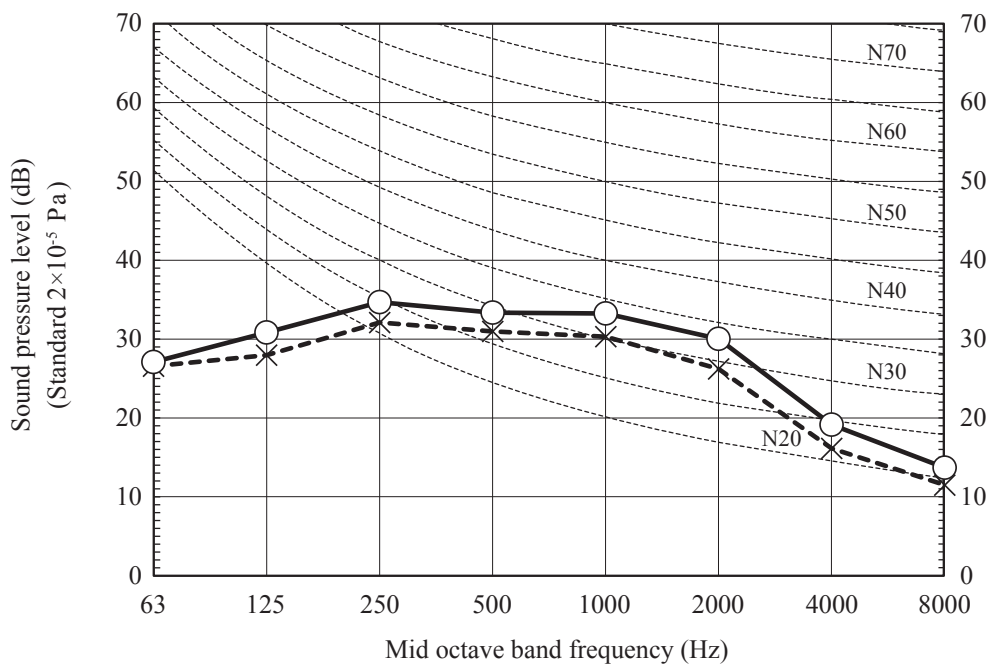

(Indoor unit)

Model	SRR60ZS-W	
Noise Level	Cooling	32 dB(A)
	Heating	34 dB(A)

Condition	ISO15042 T1/H1
-----------	----------------

MODE	Lo
------	----

● Mike position

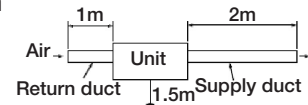

External static pressure : 10Pa

x Cooling, ○ — Heating

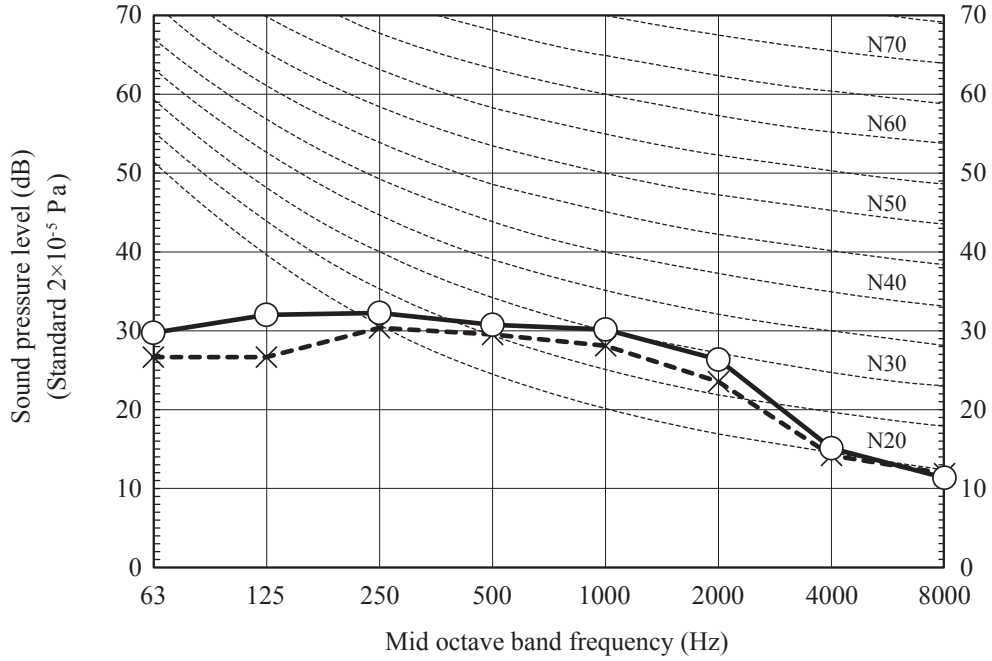

(Indoor unit)

Model	SRR60ZS-W	
Noise Level	Cooling	27 dB(A)
	Heating	29 dB(A)

Condition	ISO15042 T1/H1
-----------	----------------

MODE	ULo
------	-----

● Mike position

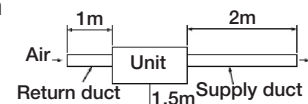

External static pressure : 10Pa

x Cooling, ○ — Heating

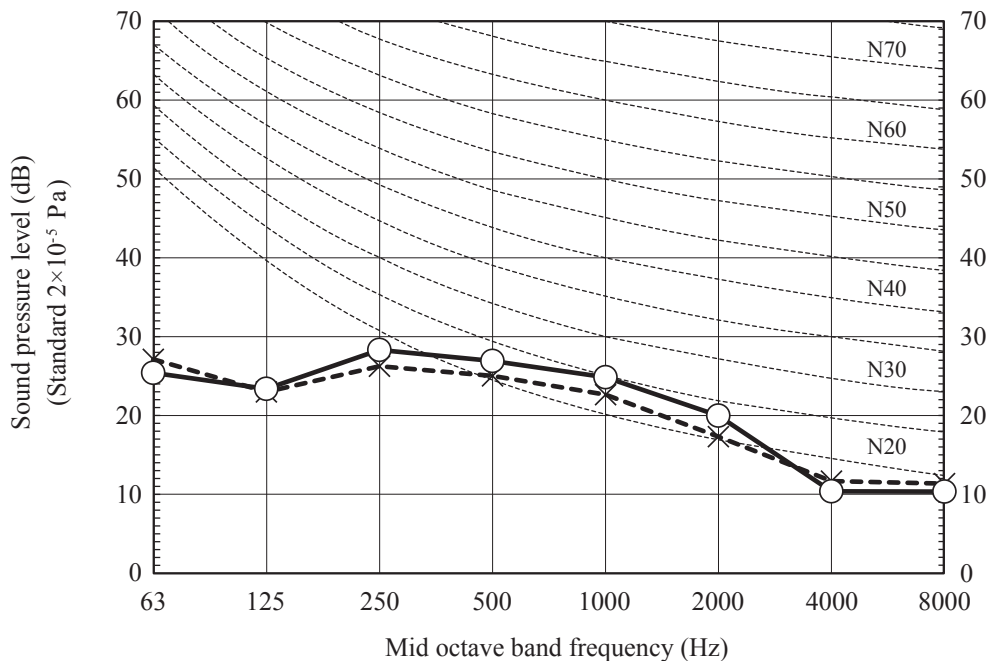

(4) 4-way ceiling cassette type (FDTC)

(a) FDTC-VH series

(i) Sound power level

Model FDTC25VH

Condition	ISO15042 T1/H1
-----------	----------------

MODE	Rated capacity value (P-Hi)
------	-----------------------------

(Indoor unit)

Model	FDTC25VH	
Noise Level	Cooling	51 dB(A)
	Heating	53 dB(A)

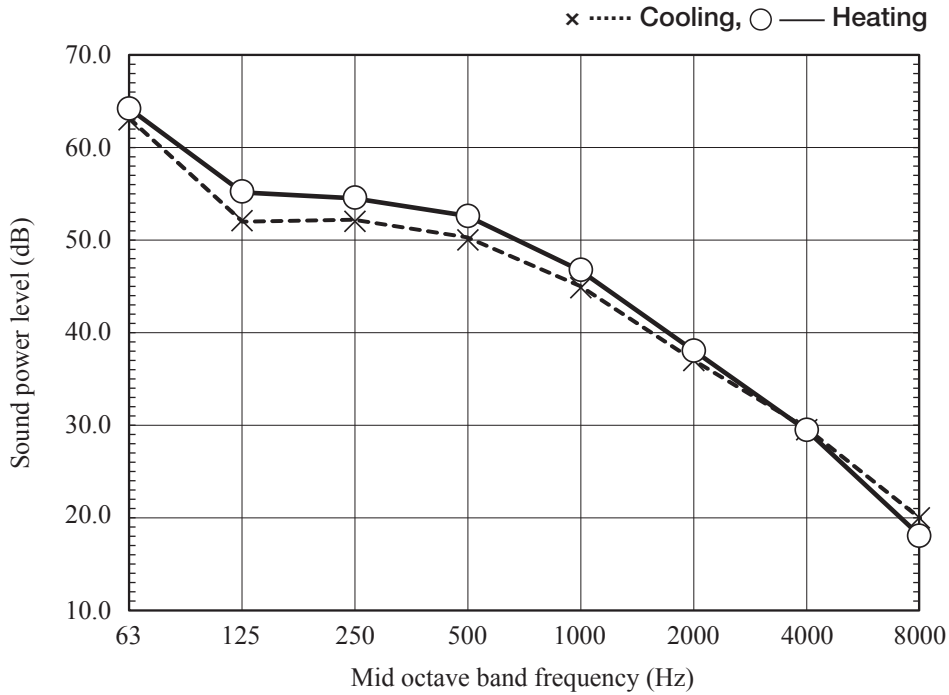

Model FDTC35VH

(Indoor unit)

Model	FDTC35VH	
Noise Level	Cooling	52 dB(A)
	Heating	54 dB(A)

Condition	ISO15042 T1/H1
-----------	----------------

MODE	Rated capacity value (P-Hi)
------	-----------------------------

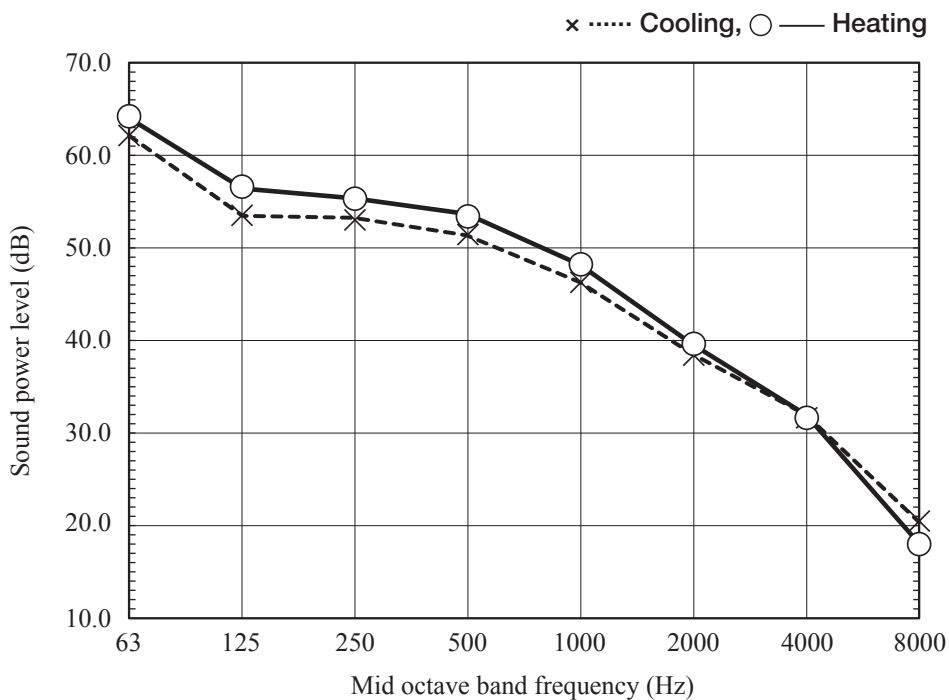

(ii) Sound pressure level
 1) Rated capacity value
 Model FDTC25VH

(Indoor unit)

Model	FDTC25VH	
Noise	Cooling	38 dB(A)
Level	Heating	39 dB(A)

Condition	ISO15042 T1/H1
MODE	Rated capacity value (P-Hi)

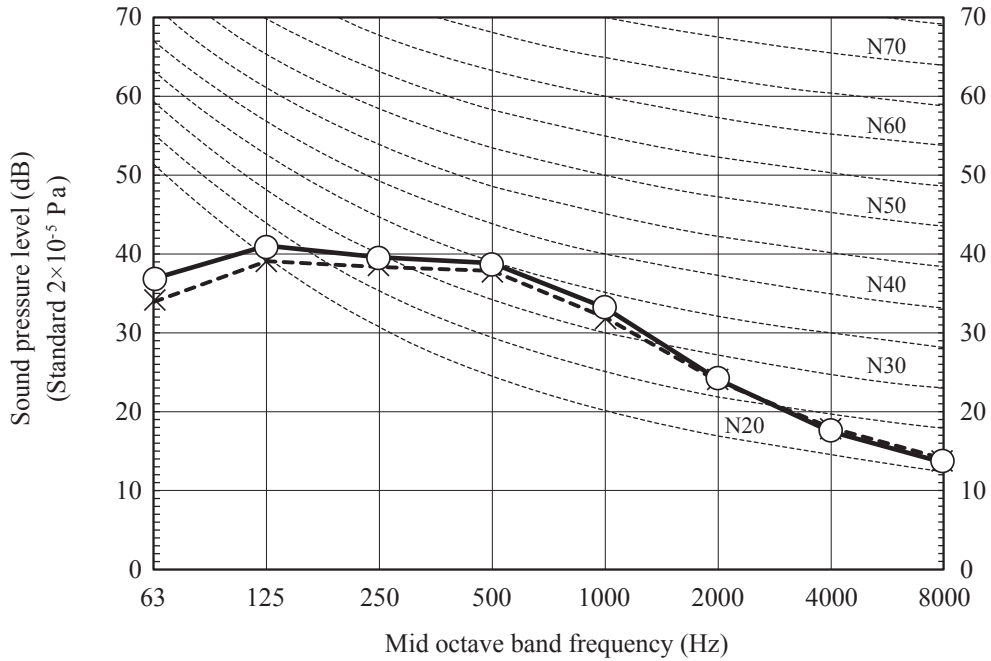
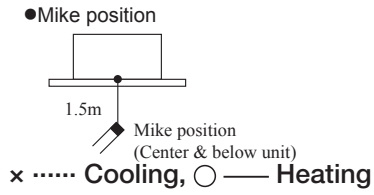

Model FDTC35VH

(Indoor unit)

Model	FDTC35VH	
Noise	Cooling	39 dB(A)
Level	Heating	41 dB(A)

Condition	ISO15042 T1/H1
MODE	Rated capacity value (P-Hi)

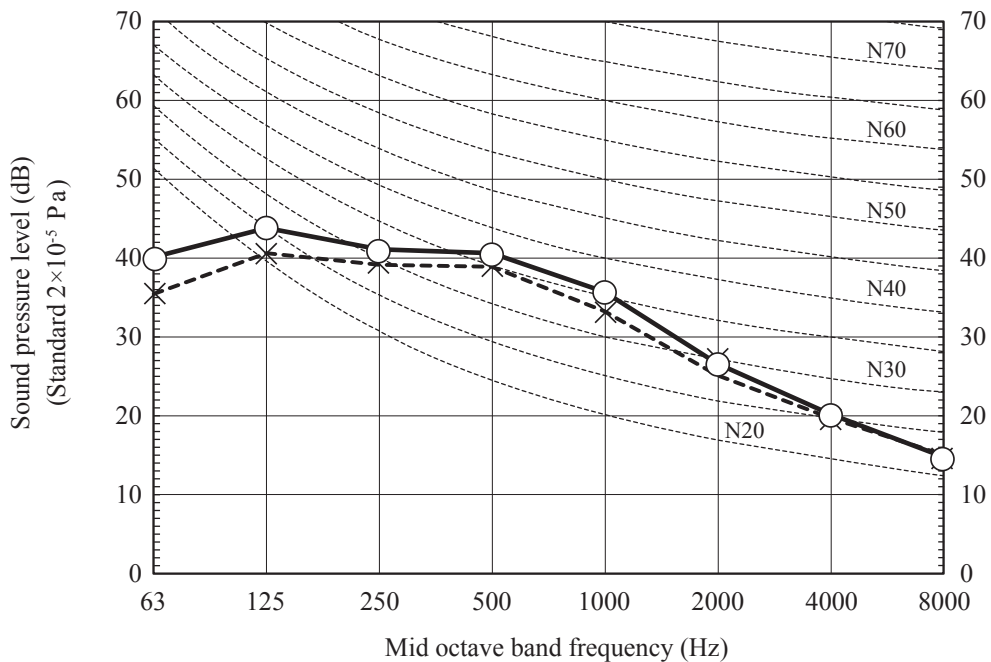
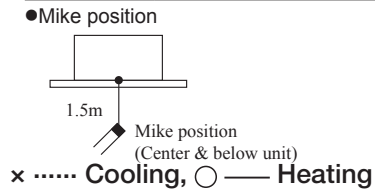

Model FDTC50VH

(Indoor unit)

Model	FDTC50VH	
Noise	Cooling	44 dB(A)
Level	Heating	44 dB(A)

Condition	ISO15042 T1/H1
-----------	----------------

MODE	Rated capacity value (P-Hi)
------	-----------------------------

● Mike position



Mike position (Center & below unit)

× Cooling, ○ — Heating

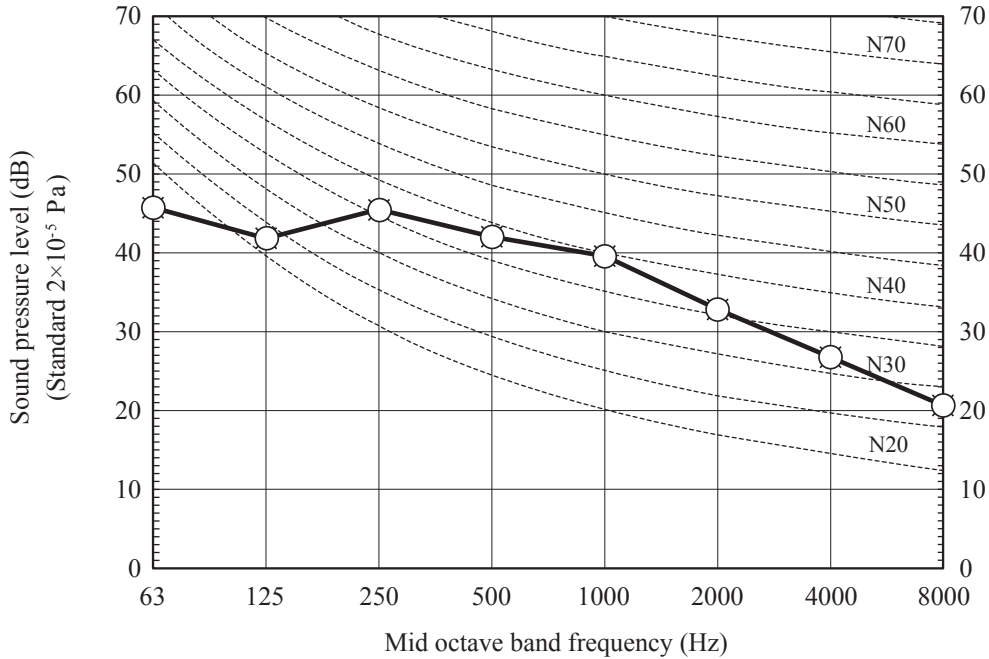

Model FDTC60VH

(Indoor unit)

Model	FDTC60VH	
Noise	Cooling	46 dB(A)
Level	Heating	46 dB(A)

Condition	ISO15042 T1/H1
-----------	----------------

MODE	Rated capacity value (P-Hi)
------	-----------------------------

● Mike position



Mike position (Center & below unit)

× Cooling, ○ — Heating

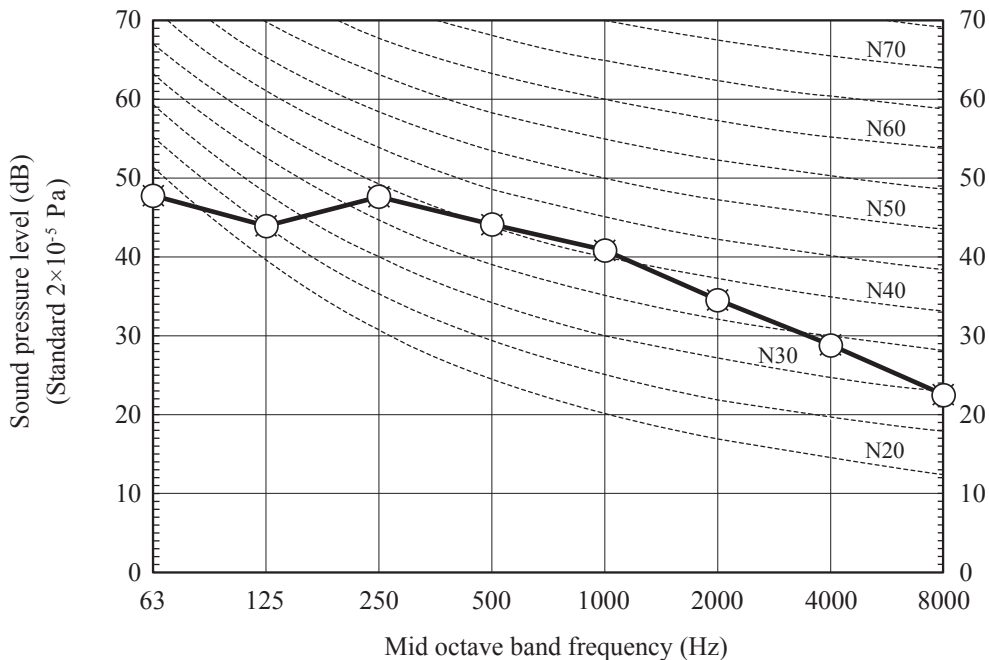

2) Each fan speed mode
Model FDTC25VH

(Indoor unit)

Model	FDTC25VH	
Noise Level	Cooling	34 dB(A)
	Heating	36 dB(A)

Condition	ISO15042 T1/H1
-----------	----------------

MODE	Hi
------	----

● Mike position

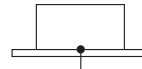

1.5m
Mike position
(Center & below unit)

x Cooling, ○ — Heating

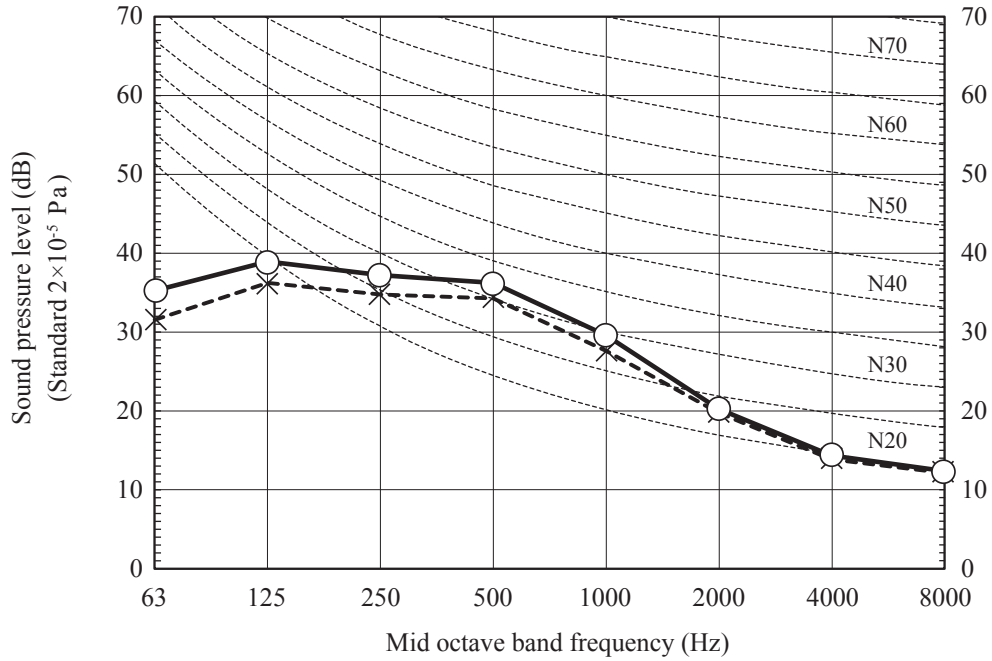

(Indoor unit)

Model	FDTC25VH	
Noise Level	Cooling	30 dB(A)
	Heating	32 dB(A)

Condition	ISO15042 T1/H1
-----------	----------------

MODE	Me
------	----

● Mike position

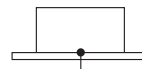

1.5m
Mike position
(Center & below unit)

x Cooling, ○ — Heating

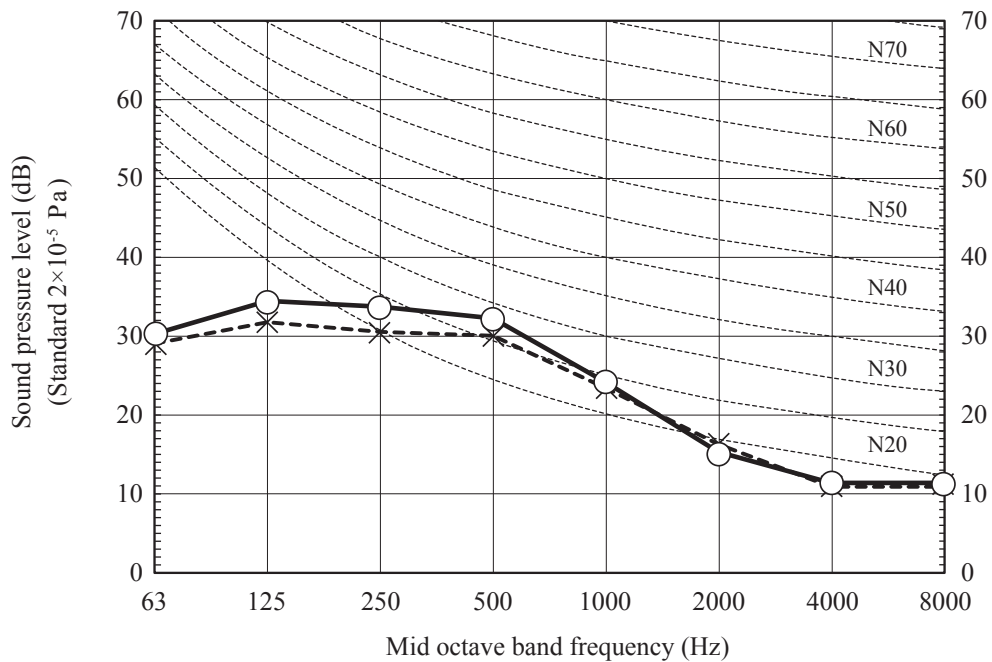

(Indoor unit)

Model	FDTC25VH	
Noise Level	Cooling	27 dB(A)
	Heating	28 dB(A)

Condition	ISO15042 T1/H1
-----------	----------------

MODE	Lo
------	----

● Mike position

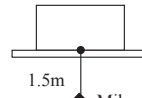

Mike position
(Center & below unit)

x Cooling, ○ — Heating

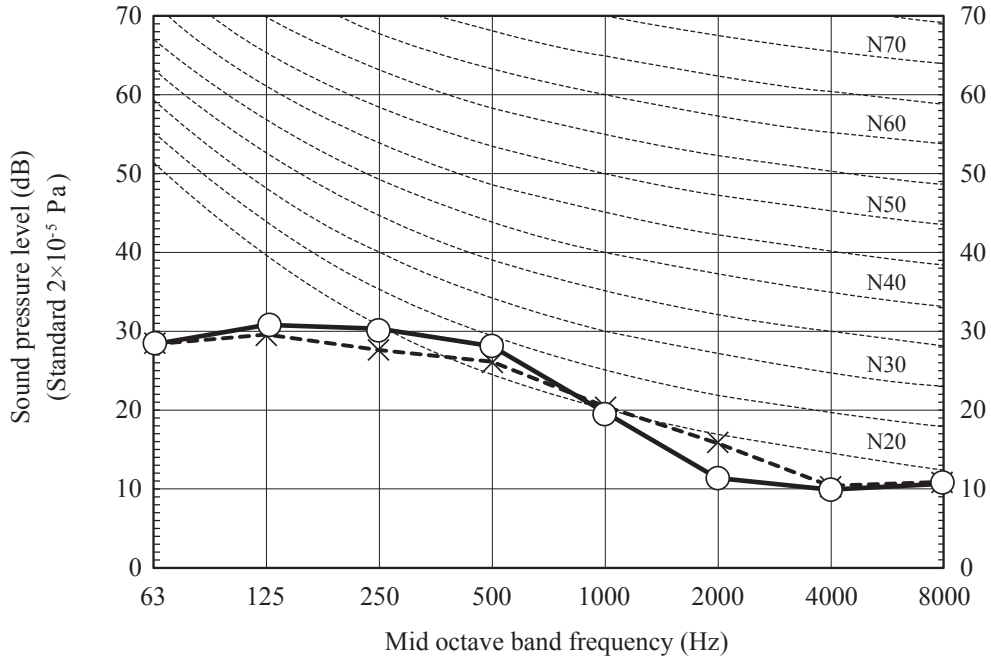

Model FDTC35VH

(Indoor unit)

Model	FDTC35VH	
Noise Level	Cooling	36 dB(A)
	Heating	38 dB(A)

Condition	ISO15042 T1/H1
-----------	----------------

MODE	Hi
------	----

● Mike position

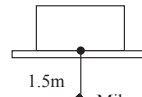

Mike position
(Center & below unit)

x Cooling, ○ — Heating

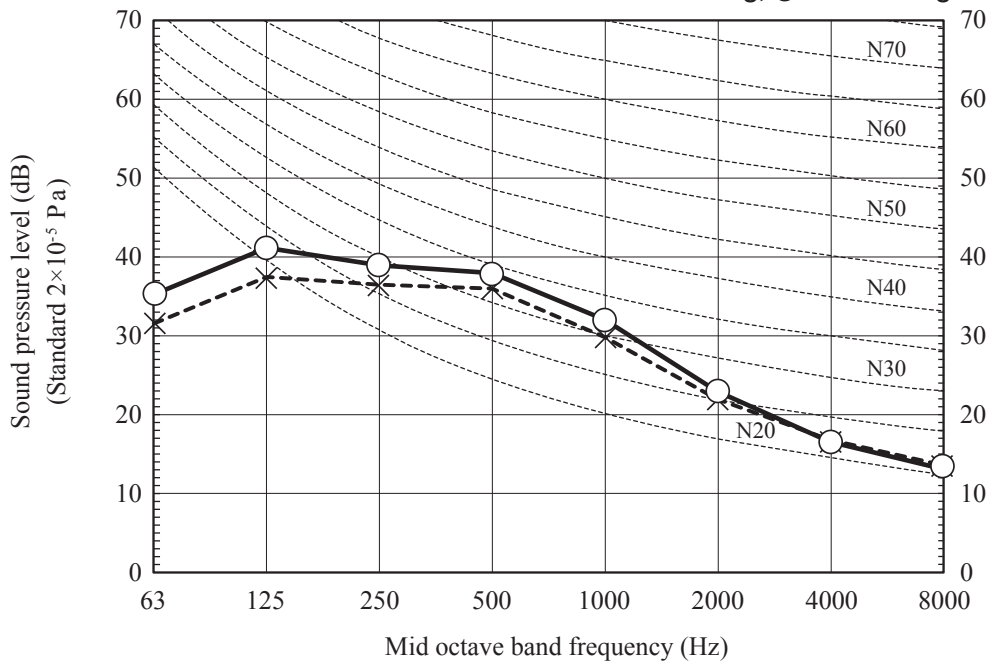

(Indoor unit)

Model	FDTC35VH	
Noise	Cooling	32 dB(A)
Level	Heating	34 dB(A)

Condition	ISO15042 T1/H1
-----------	----------------

MODE	Me
------	----

● Mike position

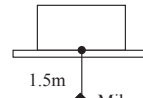

Mike position
(Center & below unit)

x Cooling, ○ — Heating

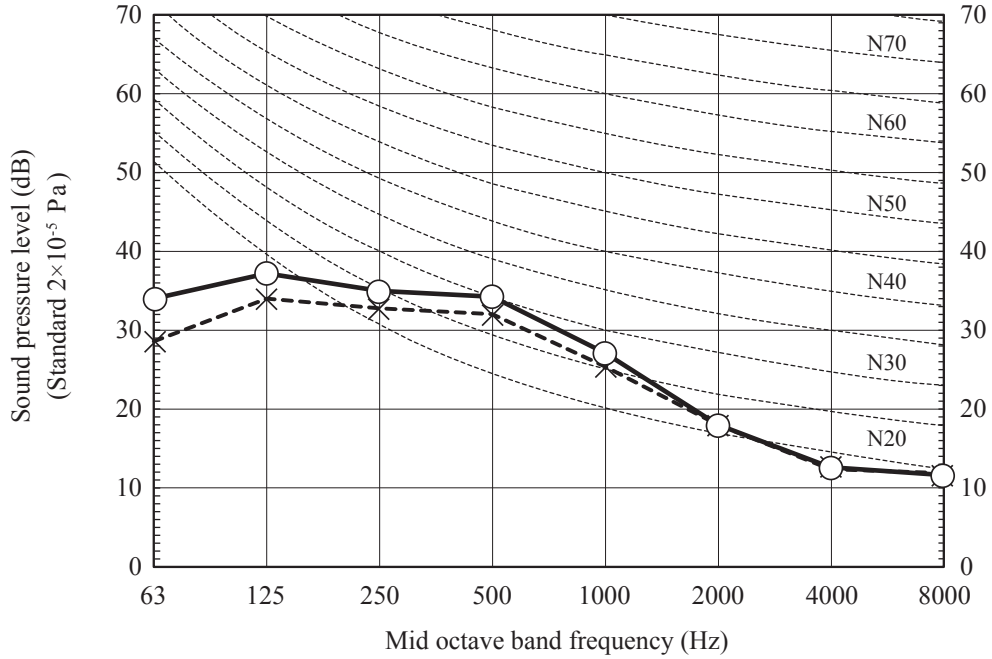

(Indoor unit)

Model	FDTC35VH	
Noise	Cooling	29 dB(A)
Level	Heating	30 dB(A)

Condition	ISO15042 T1/H1
-----------	----------------

MODE	Lo
------	----

● Mike position

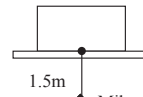

Mike position
(Center & below unit)

x Cooling, ○ — Heating

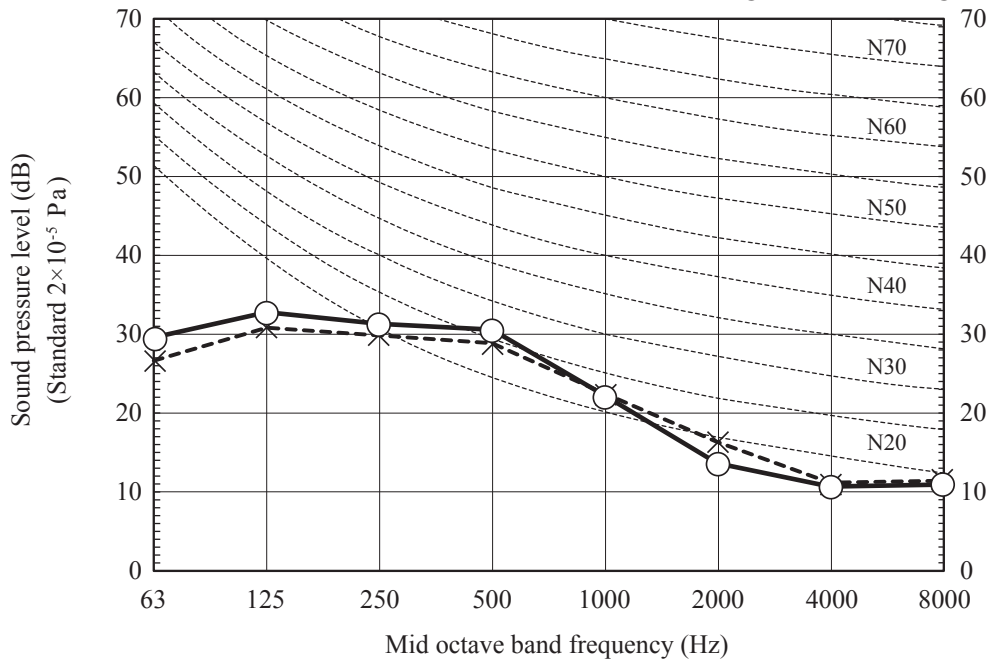

(b) FDTC-VH1 series
 (i) Sound power level
 Model FDTC25VH1

(Indoor unit)

Model	FDTC25VH1	
Noise level	Cooling	51 dB(A)
	Heating	52 dB(A)

Condition	ISO15042 T1/H1
-----------	----------------

MODE	Rated capacity value (P-Hi)
------	-----------------------------

× Cooling ○ — Heating

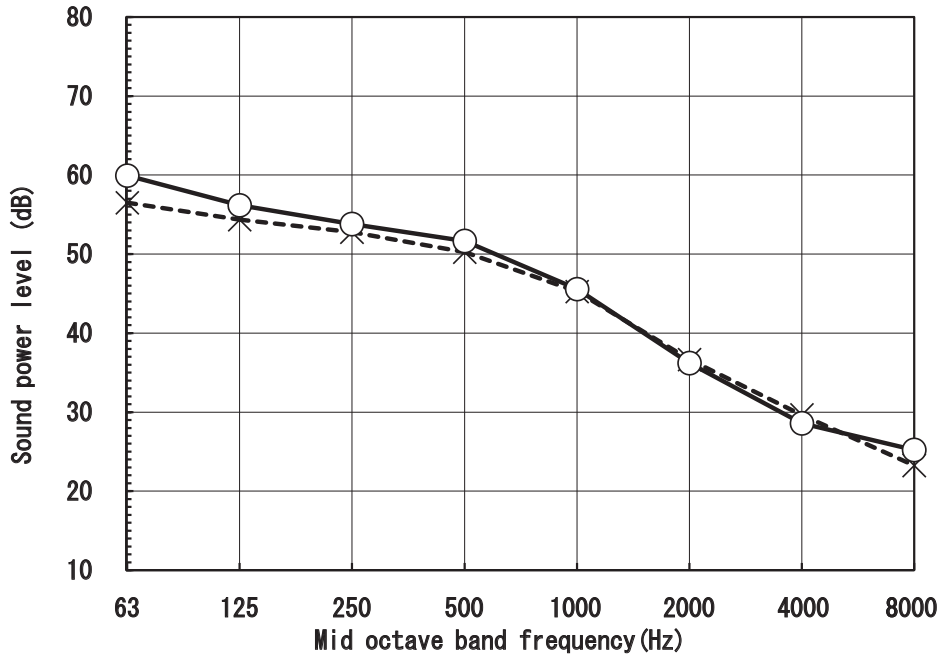

Model FDTC35VH1

(Indoor unit)

Model	FDTC35VH1	
Noise level	Cooling	52 dB(A)
	Heating	53 dB(A)

Condition	ISO15042 T1/H1
-----------	----------------

MODE	Rated capacity value (P-Hi)
------	-----------------------------

× Cooling ○ — Heating

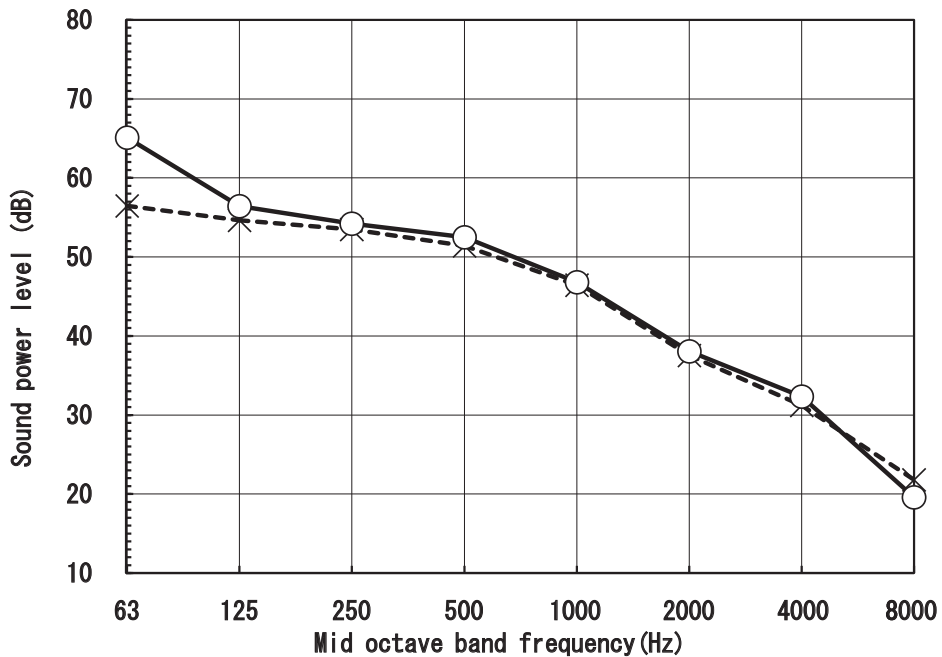

(ii) Sound pressure level

1) Rated capacity value

Model FDTC25VH1

(Indoor unit)

Model	FDTC25VH1	
Noise level	Cooling	38 dB(A)
	Heating	39 dB(A)

Condition	ISO15042 T1/H1
-----------	----------------

MODE	Rated capacity value (P-Hi)
------	-----------------------------

× Cooling ○ — Heating

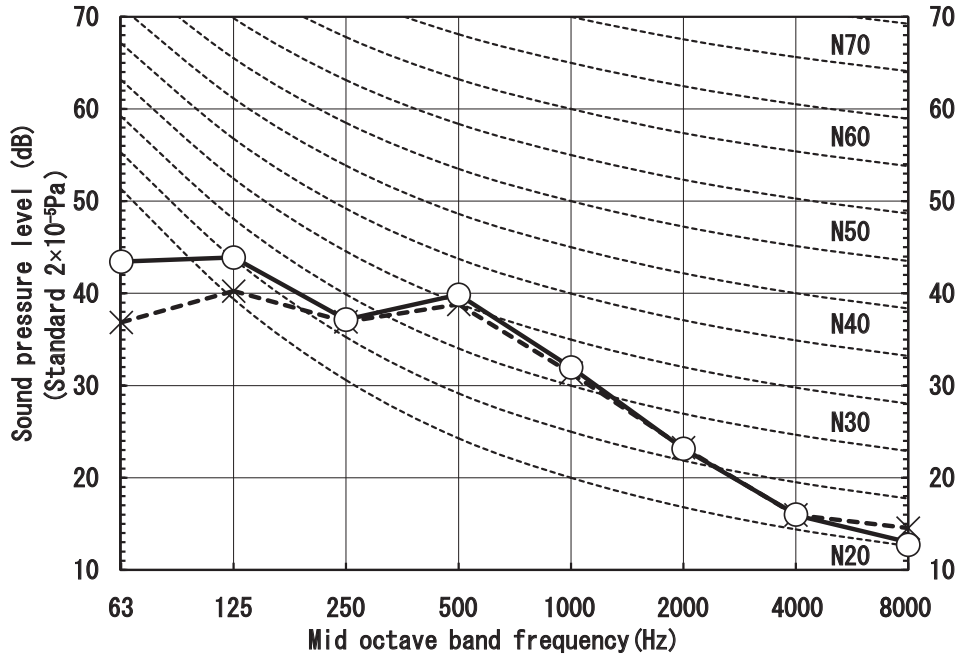

Model FDTC35VH1

(Indoor unit)

Model	FDTC35VH1	
Noise level	Cooling	39 dB(A)
	Heating	41 dB(A)

Condition	ISO15042 T1/H1
-----------	----------------

MODE	Rated capacity value (P-Hi)
------	-----------------------------

× Cooling ○ — Heating

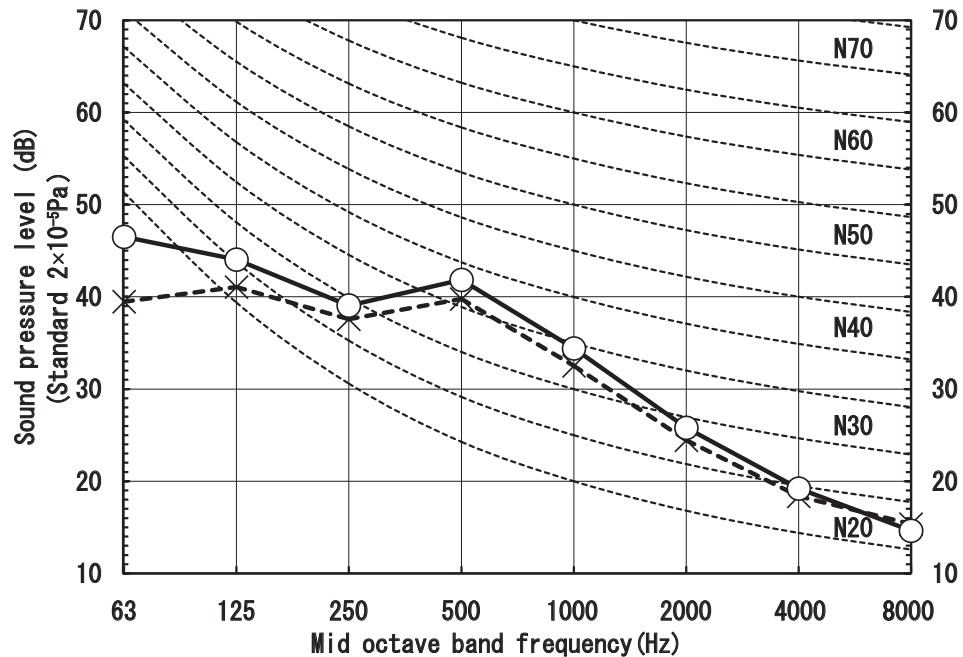

2) Each fan speed mode
Model FDTC25VH1

(Indoor unit)

Model	FDTC25VH1	
Noise level	Cooling	34 dB(A)
	Heating	36 dB(A)

Condition	ISO15042 T1/H1
-----------	----------------

MODE	Hi
------	----

× Cooling ○ — Heating

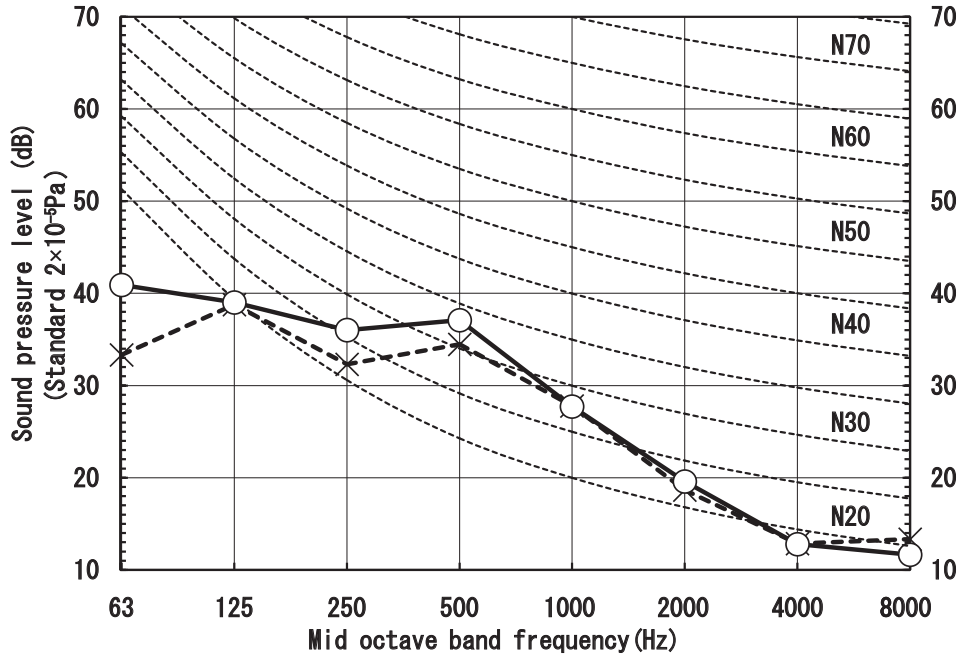

(Indoor unit)

Model	FDTC25VH1	
Noise level	Cooling	30 dB(A)
	Heating	32 dB(A)

Condition	ISO15042 T1/H1
-----------	----------------

MODE	Me
------	----

× Cooling ○ — Heating

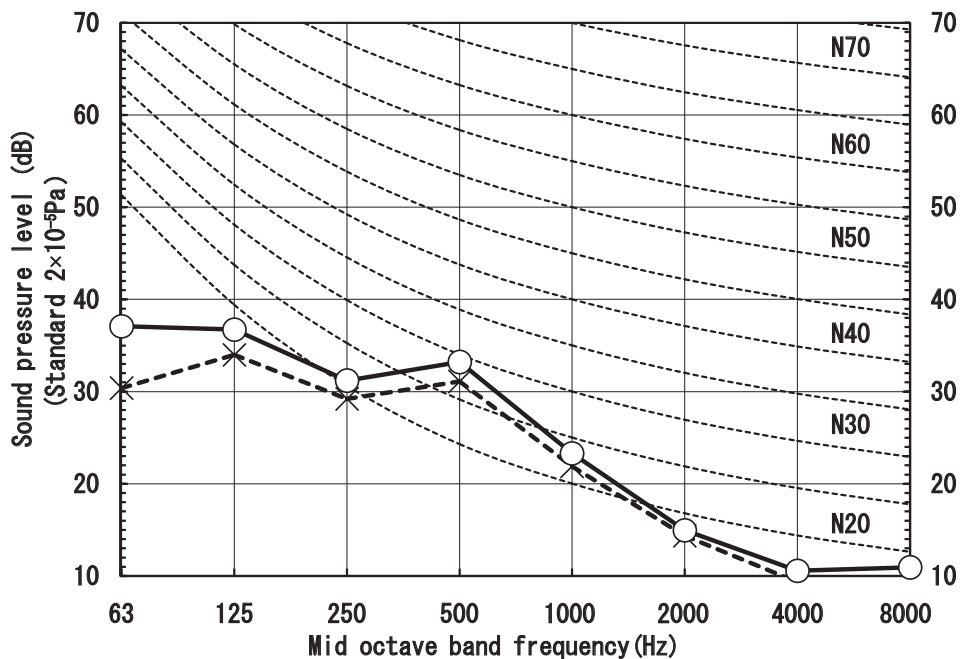

(Indoor unit)

Model	FDTC25VH1	
Noise level	Cooling	27 dB(A)
	Heating	28 dB(A)

Condition	ISO15042 T1/H1
-----------	----------------

MODE	Lo
------	----

× Cooling ○ — Heating

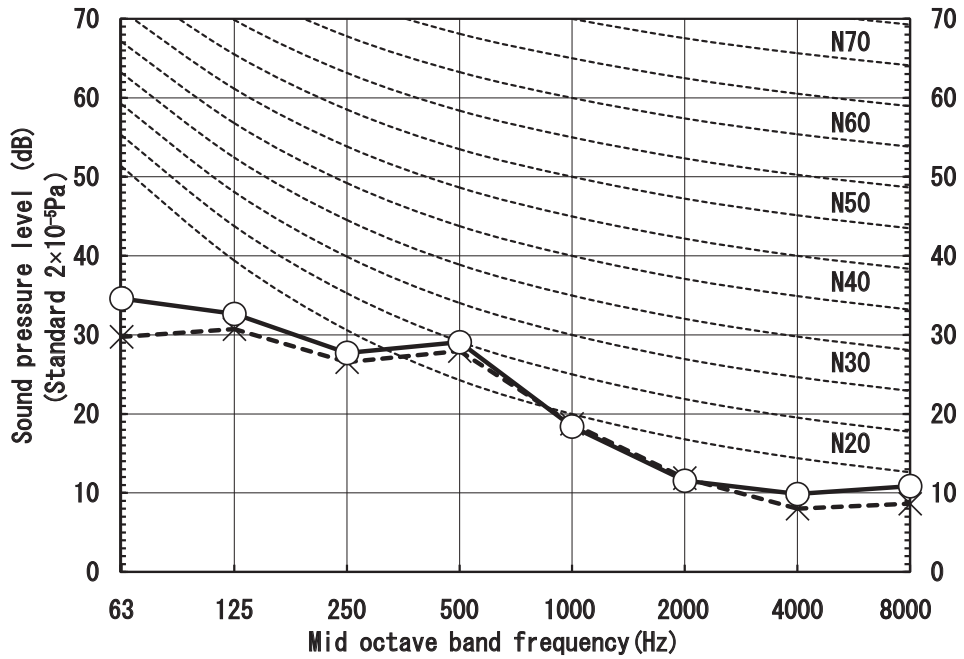

Model FDTC35VH1/1
(Indoor unit)

Model	FDTC35VH1	
Noise level	Cooling	36 dB(A)
	Heating	38 dB(A)

Condition	ISO15042 T1/H1
-----------	----------------

MODE	Hi
------	----

× Cooling ○ — Heating

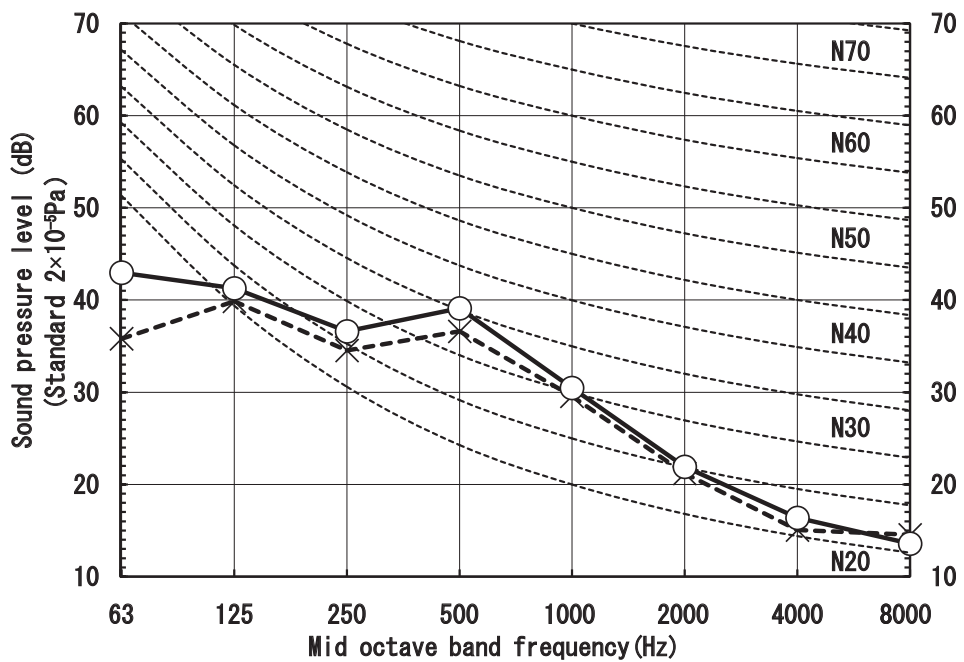

(Indoor unit)

Model	FDTC35VH1	
Noise level	Cooling	32 dB(A)
	Heating	34 dB(A)

Condition	ISO15042 T1/H1
-----------	----------------

MODE	Me
------	----

× Cooling ○ — Heating

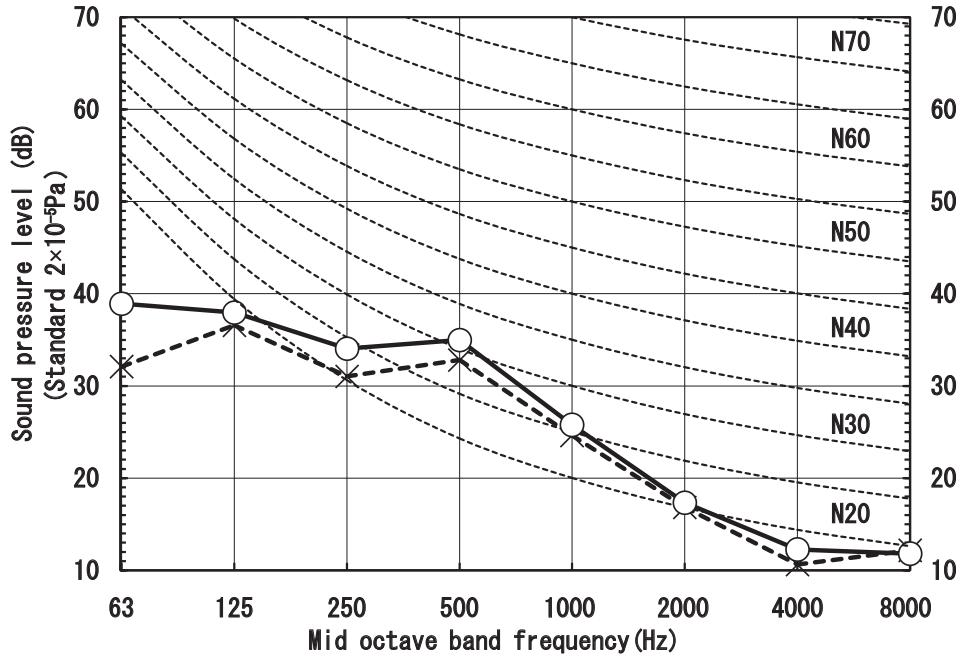

(Indoor unit)

Model	FDTC35VH1	
Noise level	Cooling	29 dB(A)
	Heating	30 dB(A)

Condition	ISO15042 T1/H1
-----------	----------------

MODE	Lo
------	----

× Cooling ○ — Heating

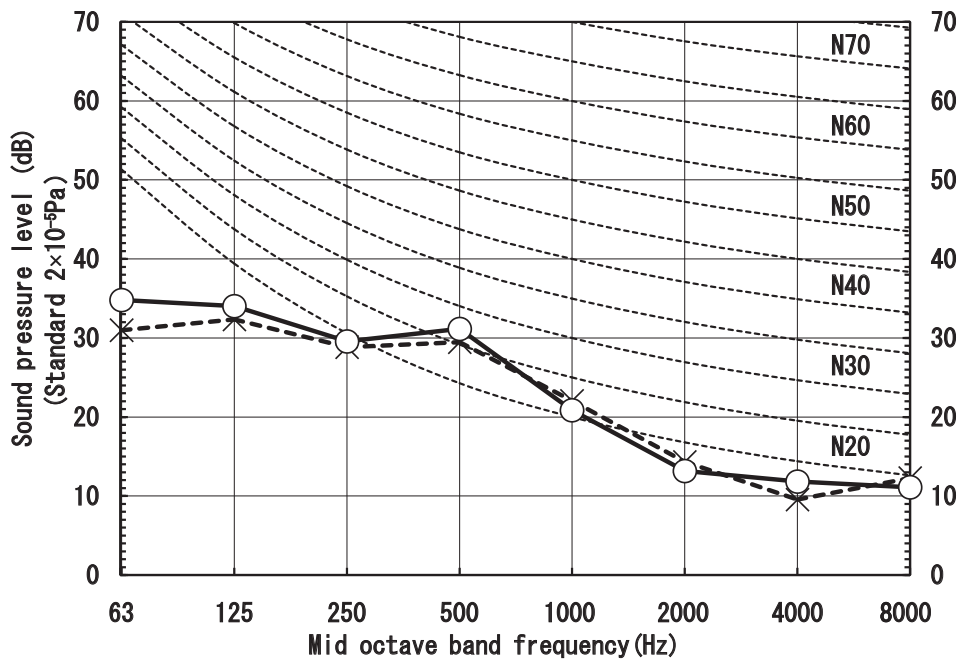

(5) Duct connected-Low/Middle static pressure type (FDUM)
Model FDUM50VH

Noise Level	Cooling	37 dB(A)
	Heating	37 dB(A)

Condition	ISO15042 T1/H1
-----------	----------------

MODE	Rated capacity value (P-Hi)
------	-----------------------------

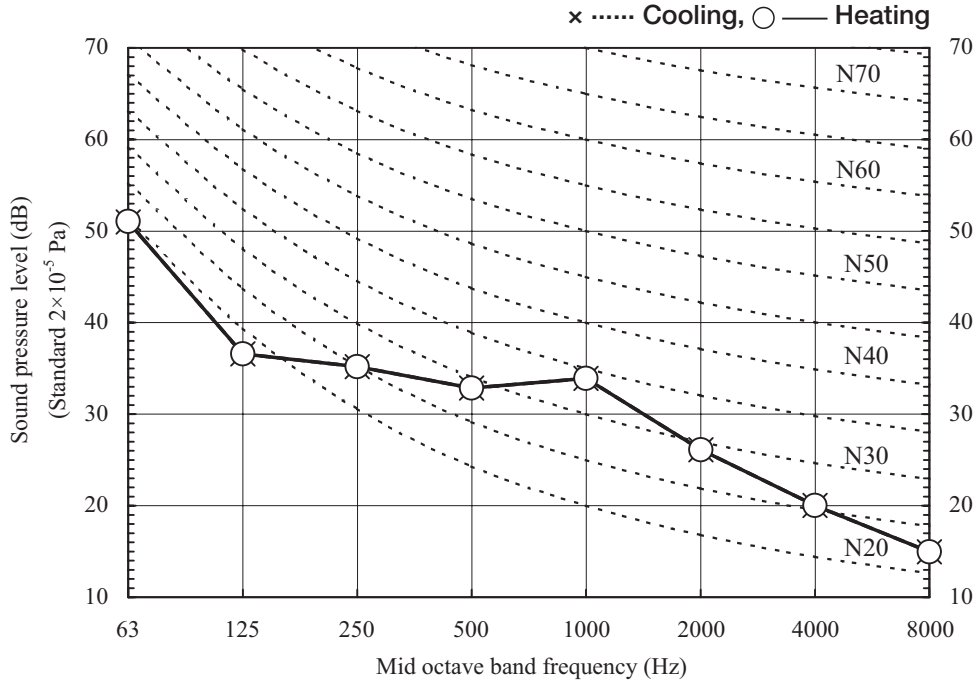
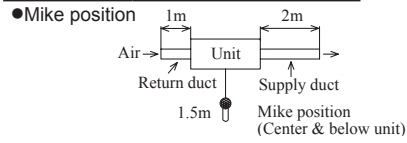

(6) Ceiling suspended type (FDE)

Model FDE50VH

Noise Level	46 dB (A) at P-HIGH
	38 dB (A) at HIGH
	36 dB (A) at MEDIUM
	31 dB (A) at LOW

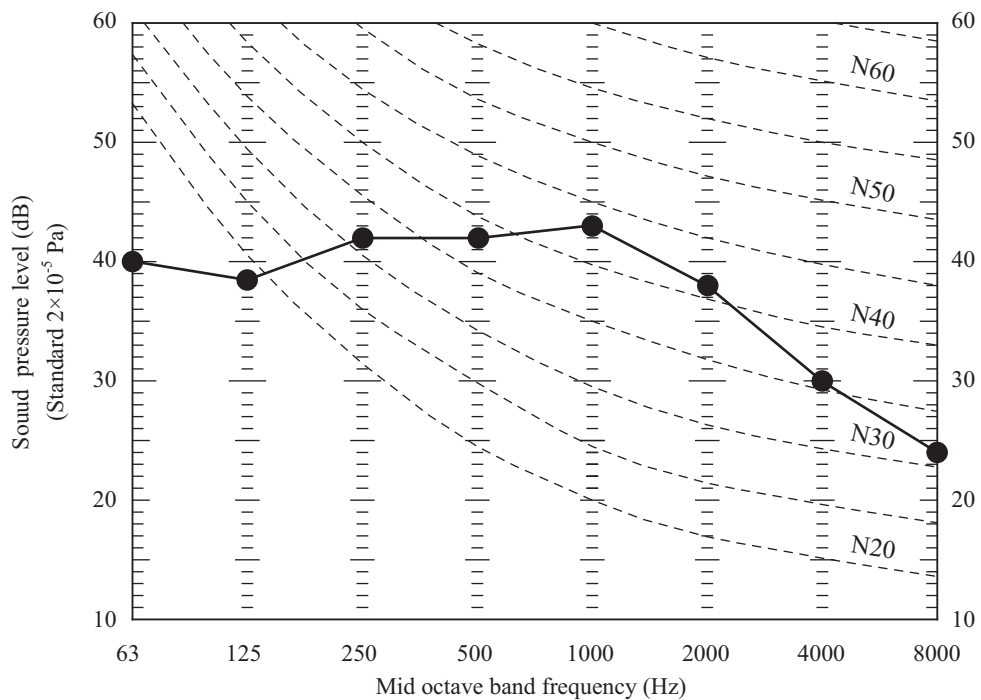
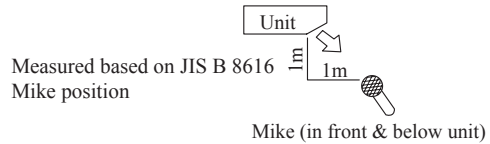

2.5 Characteristics of fan

(1) Ceiling concealed type (SRR)

Model SRR25ZM-W, 25ZS-W

Cooling

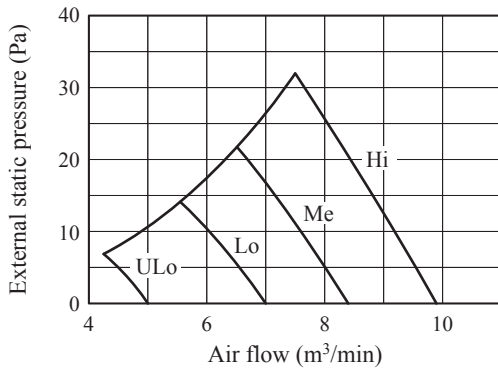

Heating

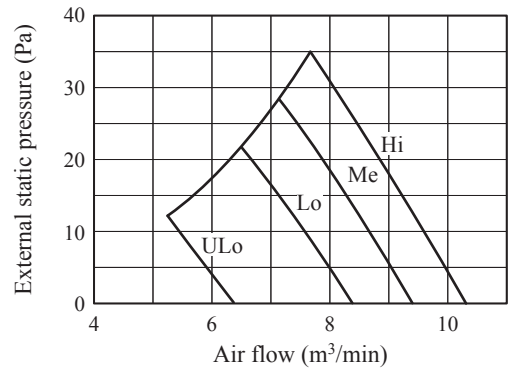

Model SRR35ZM-W, 35ZS-W

Cooling

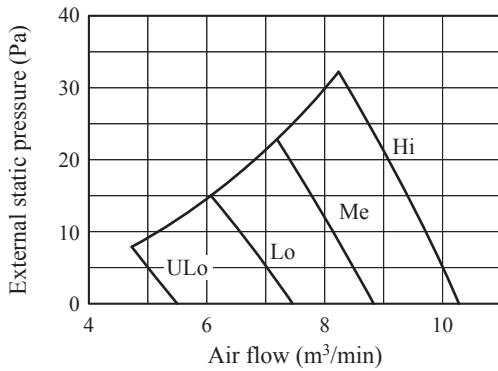

Heating

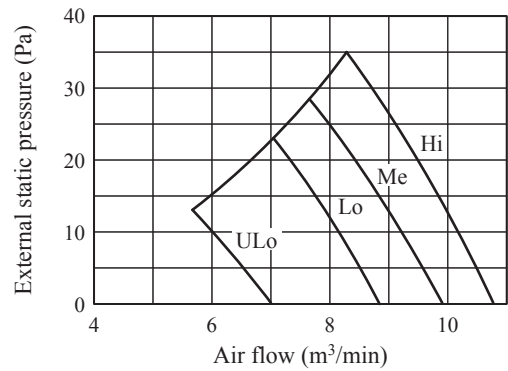

Model SRR50ZS-W

Cooling

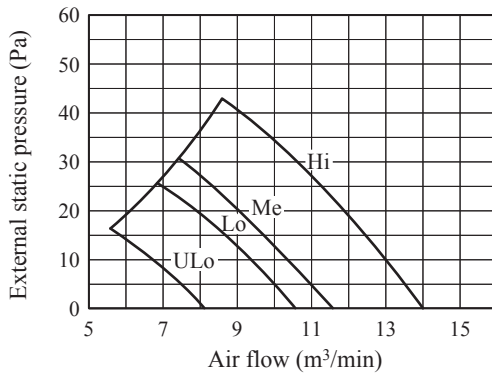

Heating

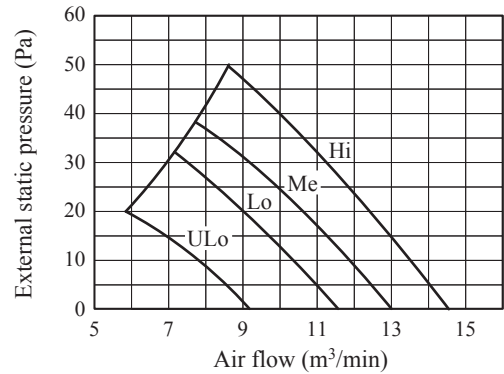

Model SRR60ZS-W

Cooling

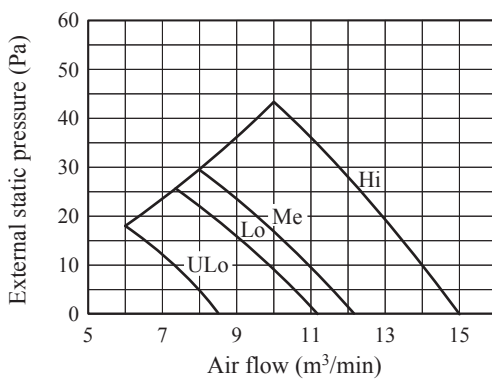

Heating

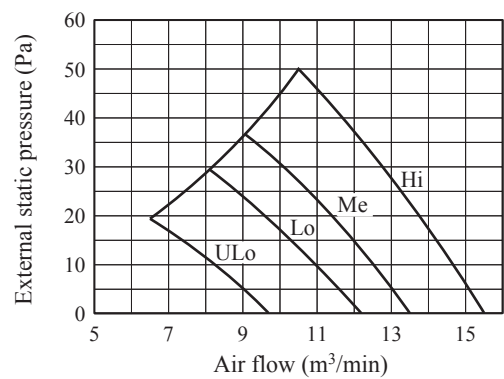

(2) Duct connected-Low/Middle static pressure type (FDUM)

- Characteristic FAN (1) shows air flow vs. External Static Pressure (E.S.P.) range where settings of E.S.P. are maximum E.S.P. (100Pa), rated E.S.P., and minimum E.S.P. (10Pa).
- Characteristic FAN (2) shows air flow vs. E.S.P. curve when set fan tap is set P-Hi with each setting of E.S.P. by wired remote control.
- External Static Pressure (E.S.P.) can be set by wired remote control.
- You can set required E.S.P. by wired remote control which calculate it with the set air flow rate and pressure loss of the duct connected.

Model FDUM50VH

Characteristic FAN(1)

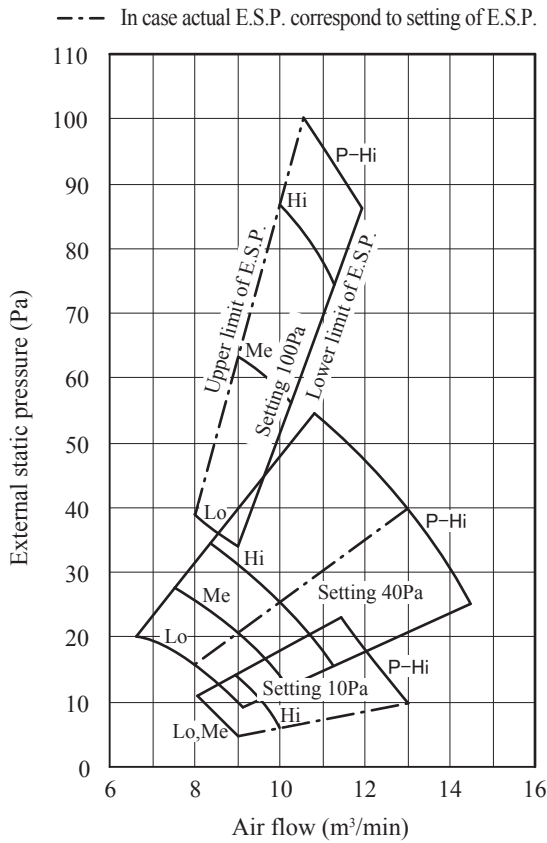

Characteristic FAN(2)

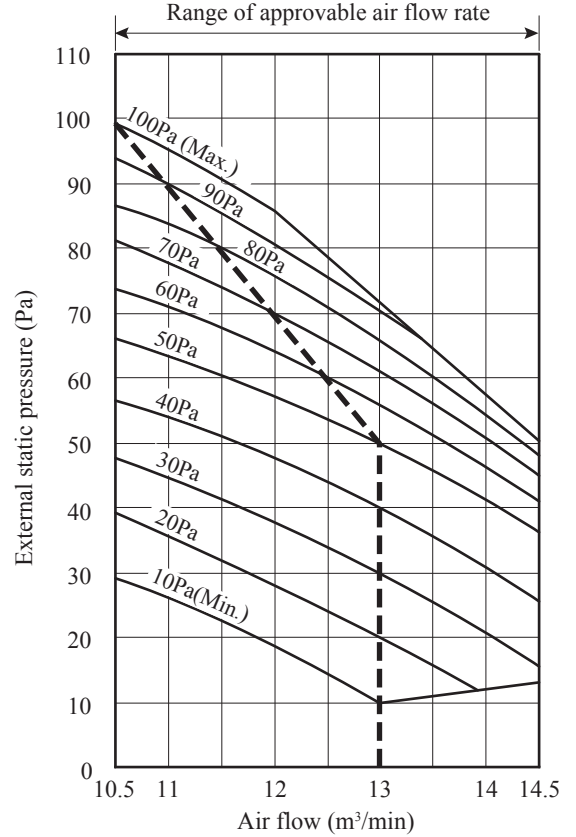

2.6 Application data

(1) Wall mounted type (SRK, SKM)

(a) Models SRK20ZSX, 25ZSX, 35ZSX, 50ZSX, 60ZSX

RLF012A202B

Model SRK20,25,35,50,60ZSX
R32/R410A REFRIGERANT USED

- This installation manual deals with an indoor unit installation only. For an outdoor unit installation, refer to page 9.
- This unit is designed for R32 or R410A. See a label on the outdoor unit to check refrigerant information.

SAFETY PRECAUTIONS

- Before installation, read the "SAFETY PRECAUTIONS" carefully and strictly follow it during the installation work in order to protect yourself.
 - The precautionary items mentioned below are distinguished into two levels, **WARNING** and **CAUTION**.
 - **WARNING** Indicates a potentially hazardous situation which, if not avoided, can result in serious consequences such as death or severe injury.
 - **CAUTION** Indicates a potentially hazardous situation which, if not avoided, can result in personal injury or property damage.
- Both mention the important items to protect your health and safety. Therefore, strictly follow them by any means.









WARNING

- **Be sure to use only for residential purpose.**
If this unit is installed in inferior environment such as machine shop, vehicle (like ship), warehouse, etc., it can malfunction.
- **Installation must be carried out by the qualified installer completely in accordance with the installation manual.**
Installation by non qualified person or incorrect installation can cause serious troubles such as water leak, electric shock, fire and personal injury.
- **Be sure to wear protective goggles and gloves while performing installation work.**
Improper safety measures can result in personal injury.
- **Use the original accessories and the specified components for the installation.**
Using parts other than those prescribed may cause water leak, electric shock, fire and personal injury.
- **Do not install the unit near the location where leakage of flammable gases can occur.**
If leaked gases accumulate around the unit, it can cause fire resulting in property damage and personal injury.
- **When installing the unit in small rooms, make sure that refrigerant density does not exceed the limit (Reference: ISO5149) in the event of leakage.**
If refrigerant density exceeds the limit, consult the dealer and install the ventilation system. Otherwise lack of oxygen can occur resulting in serious accident.
- **Install the unit in a location where unit will remain stable, horizontal and free of any vibration transmission.**
Unsuitable installation location can cause the unit to fall resulting in material damage and personal injury.
- **Do not run the unit with removed panels or protections.**
Touching rotating equipments, hot surfaces or high voltage parts can cause personal injury due to entrapment, burn or electric shock.
- **This unit is designed specifically for R32 or R410A.**
Using any other refrigerant can cause unit failure and personal injury.
- **Do not vent R32 or R410A into atmosphere.**
R32 is a fluorinated greenhouse gas with a Global Warming Potential(GWP)=675.
R410A is a fluorinated greenhouse gas with a Global Warming Potential(GWP)=2088.
- **Make sure that no air enters the refrigerant circuit when the unit is installed and removed.**
If air enters the refrigerant circuit, the pressure in the refrigerant circuit will become too high, which can cause burst and personal injury.
- **Be sure to use the prescribed pipes, flare nuts and tools for R32 or R410A.**
Using existing parts (for R22 or R407C) can cause refrigerant circuit burst resulting in unit failure and personal injury.
- **Be sure to connect both liquid and gas connecting pipes properly before operating the compressor.**
Do not open the liquid and gas service valves before completing piping work and evacuation.
If the compressor is operated when connecting pipes are not connected and service valves are open, air can be sucked into the refrigerant circuit which can cause anomalous high pressure resulting in burst or personal injury.
- **Be sure to tighten the flare nuts to specified torque using the torque wrench.**
Tightening flare nuts with excess torque can cause burst and refrigerant leakage after a long period.
- **During pump down work, be sure to stop the compressor before closing service valves and removing connecting pipes.**
If the connecting pipes are removed when the compressor is in operation and service valves are open, air can be sucked into the refrigerant circuit which can cause anomalous high pressure resulting in burst or personal injury.
- **In the event of refrigerant leakage during installation, be sure to ventilate the working area properly.**
If the refrigerant comes into contact with naked flames, poisonous gases will be produced.
- **Electrical work must be carried out by the qualified electrician, strictly in accordance with national or regional electricity regulations.**
Incorrect installation can cause electric shock, fire or personal injury.
- **Make sure that earth leakage breaker and circuit breaker of appropriate capacities are installed.**
Circuit breaker should be able to disconnect all poles under over current. Absence of appropriate breakers can cause electric shock, personal injury or property damage.
- **Be sure to switch off the power source in the event of installation, maintenance or service.**
If the power source is not switched off, there is a risk of electric shock, unit failure or personal injury.
- **Be sure to tighten the cables securely in terminal block and relieve the cables properly to prevent overloading the terminal blocks.**
Loose connections or cable mountings can cause anomalous heat production or fire.
- **Do not process, splice or modify the power cable, or share the socket with other power plugs.**
Improper power cable or power plug can cause fire or electric shock due to poor connection, insufficient insulation or over-current.
- **Do not perform any change in protective device or its setup condition yourself.**
Changing protective device specifications can cause electric shock, fire or burst.
- **Be sure to clamp the cables properly so that they do not touch any internal component of the unit.**
If cables touch any internal component, it can cause overheating and fire.
- **Be sure to install service cover properly.**
Improper installation can cause electric shock or fire due to intrusion of dust or water.
- **Be sure to use the prescribed power and connecting cables for electrical work.**
Using improper cables can cause electric leak or fire.
- **This appliance must be connected to main power source by means of a circuit breaker or switch with a contact separation of at least 3mm.**
Improper electrical work can cause unit failure or personal injury.
- **When plugging this unit, a plug conforming to the standard IEC60884-1 must be used.**
Using improper plug can cause electric shock or fire.
- **Be sure to connect the power source cable with power source properly.**
Improper connection can cause intrusion of dust or water resulting in electric shock or fire.

CAUTION

- **Take care when carrying the unit by hand.**
If the unit weight is more than 20kg, it must be carried by two or more persons. Do not carry the unit by the plastic straps. Always use the carry handle.
- **Do not install the outdoor unit in a location where insects and small animals can inhabit.**
Insects and small animals can enter the electrical parts and cause damage resulting in fire or personal injury. Instruct the user to keep the surroundings clean.
- **If the outdoor unit is installed at height, make sure that there is enough space for installation, maintenance and service.**
Insufficient space can result in personal injury due to falling from the height.
- **Do not install the unit near the location where neighbours are bothered by noise or air generating from the unit.**
It can affect surrounding environment and cause a claim.
- **Do not install in the locations where unit is directly exposed to corrosive gases (like sulphide gas, chloride gas), sea breeze or salty atmosphere.**
It can cause corrosion of heat exchanger and damage to plastic parts.
- **Do not install the unit close to the equipments that generate electromagnetic waves and/or high-harmonic waves.**
Equipment such as inverters, standby generators, medical high frequency equipments and telecommunication equipments can affect the system, and cause malfunctions and breakdowns. The system can also affect medical equipment and telecommunication equipment, and obstruct its function or cause jamming.
- **Do not install the unit in the locations where:**
 - There are heat sources nearby.
 - Unit is directly exposed to rain or sunlight.
 - There is any obstacle which can prevent smooth air circulation from inlet and outlet side of the unit.
 - Unit is directly exposed to oil mist and steam such as kitchen.
 - Chemical substances like ammonia (organic fertilizer), calcium chloride (snow melting agent) and acid (sulfurous acid etc.), which can harm the unit, will generate or accumulate.
 - Drain water can not be discharged properly.
 - TV set or radio receiver is placed within 1m.
 - Height above sea level is more than 1000m.
 It can cause performance degradation, corrosion and damage of components, unit malfunction and fire.
- **Dispose of all packing materials properly.**
Packing materials contain nails and wood which can cause personal injury. Keep the polybag away from children to avoid the risk of suffocation.
- **Do not put anything on the outdoor unit.**
Object may fall causing property damage or personal injury.
- **Do not touch the aluminum fin of the outdoor unit.**
Aluminium fin temperature is high during heating operation. Touching fin can cause burn.
- **Do not touch any refrigerant pipe with your hands when the system is in operation.**
During operation the refrigerant pipes become extremely hot or extremely cold depending on the operating condition. Touching pipes can cause personal injury like burn (hot/cold).
- **Install isolator or disconnect switch on the power source wiring in accordance with the local codes and regulations.**
The isolator should be locked in OFF state in accordance with EN60204-1.

1. ACCESSORIES AND TOOLS

Standard accessories (Supplied with indoor unit)				Locally procured parts		Tools for installation work	
(1) Installation board	 1pc.	(5) Wood screws (for remote control holder ϕ 3.5 X 16mm)	 2pcs.	(a) Sleeve (1pc.)		Plus headed driver	Pipe cutter
(2) Wireless remote control	 1pc.	(6) Batteries [R03 (AAA, Micro) 1.5V]	 2pcs.	(b) Sealing plate (1pc.)		Knife	Hole core drill (65mm in diameter)
(3) Remote control holder	 1pc.	(7) Air-cleaning filters	 2pcs.	(c) Inclination plate (1pc.)		Saw	Wrench key (Hexagon) [4mm]
(4) Tapping screws (for installation board ϕ 4 X 25mm)	 5pcs.	(8) Insulation (#486 50 X 100 t3)	 1pc.	(d) Putty		Tape measure	Flaring tool set*
				(e) Connecting cable		Torque wrench (14.0-62.0N·m (1.4-6.2kgf·m))	Gas leak detector*
				(f) Drain hose (extension hose)			Pipe bender
				(g) Piping cover (for insulation of connection piping)			Flare adjustment gauge
				(h) Clamp and screw (for finishing work)			
				(i) Electrical tape			

* Designed specifically for R32 or R410A

2. SELECTING INSTALLATION LOCATION

After getting customer's approval, select installation location according to following guidelines.

1. Indoor unit

- Where there is no obstruction to the airflow and where the cooled and heated air can be evenly distributed.
- A solid place where the unit or the wall will not vibrate.
- A place where there will be enough space for servicing. (Where space mentioned on the right side can be secured.)
- Where it is easy to conduct wiring and piping work.
- A place where unit is not directly exposed to sunlight or street light.
- A place where it can be easily drained.
- A place separated at least 1m away from the television or the radio. (To prevent interference to images and sounds.)
- A place where this unit is not affected by the high frequency equipment or electric equipment.
- Avoid installing this unit in place where there is much oil mist.
- A place where there is no electric equipment or household.
- Install the indoor unit on the wall where the height from the floor to the bottom of the unit is more than 180 cm.

2. Wireless remote control

- A place where the air-conditioner can receive the signal surely during operating the wireless remote control.
- A place where it is not affected by the TV, radio etc.
- Do not place where it is exposed to direct sunlight or near heat devices such as a stove.

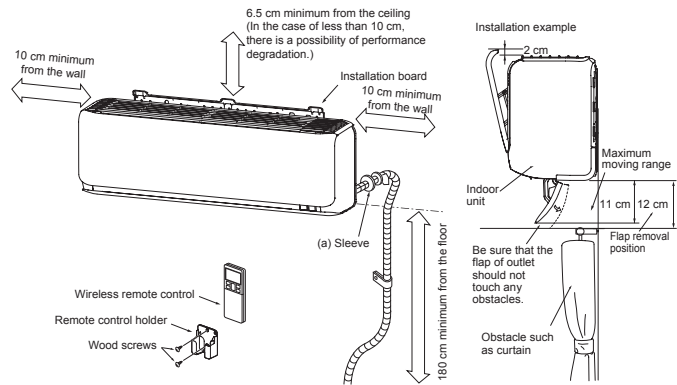

3. INSTALLING INSTALLATION BOARD

- Installation board should be installed on the wall which can support the weight of the indoor unit.
- Adjustment of the installation board in the horizontal direction is to be conducted with 5 screws in a temporary tightened state.
- With the standard hole as a center, adjust the board and level it.

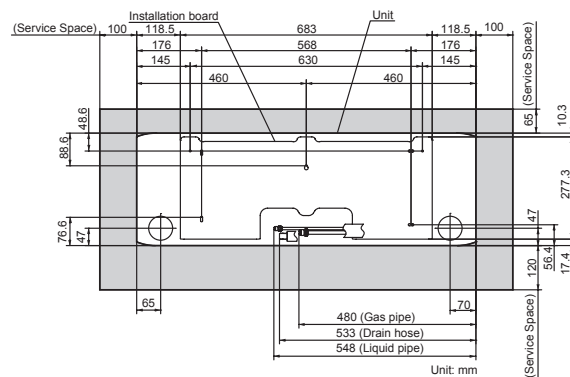
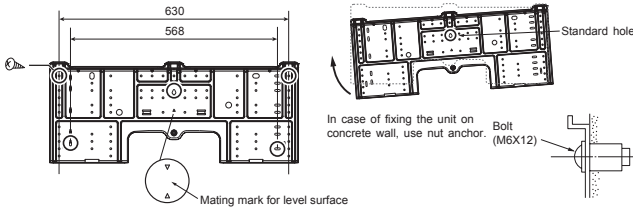

4. DRILLING HOLE AND FIXTURE OF SLEEVE

When drilling the wall that contains a metal lath, wire lath or metal plate, be sure to use sealing plate, sleeve and inclination plate (Locally procured parts).

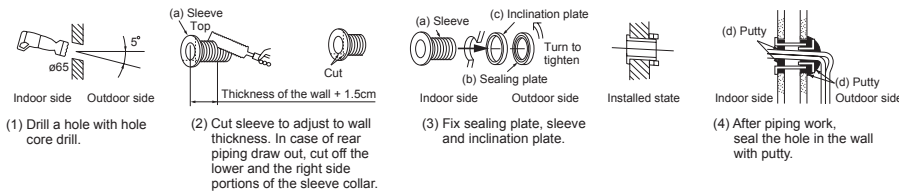

5. ELECTRICAL WIRING WORK

- Before installation, make sure that the power source complies with the air-conditioner's power specification.
- Carry out electrical wiring work according to following guidelines.

1. Preparing cable

- (1) Selecting cable
Select the connecting cable in accordance with the specifications mentioned below.
4-core* 1.5mm² conformed with 60245 IEC57
* 1 Earth wire is included (Yellow/Green).
- (2) Arrange each wire length as shown below.
Make sure that each wire is stripped 10mm from the end.

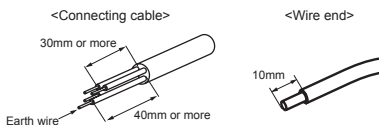

- (3) Attach round crimp-type terminal to each wire as shown in the below.
Select the size of round crimp-type terminal after considering the specifications of terminal block and wire diameter.

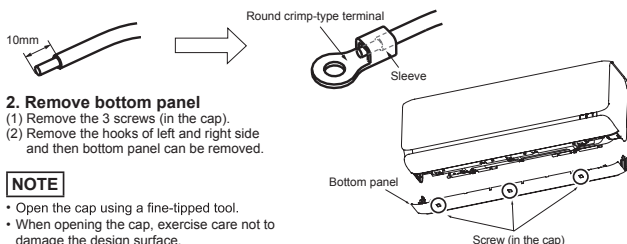

3. Connecting cable

- (1) Remove the terminal cover.
- (2) Remove the cable clamp.
- (3) Connect the connecting wires to the terminal block.
- (4) Fix the connecting cable by cable clamp.
- (5) Fix the terminal cover.

NOTE

Take care not to confuse the terminal numbers for indoor and outdoor connections.

The screw of the terminal cover is tightened securely.

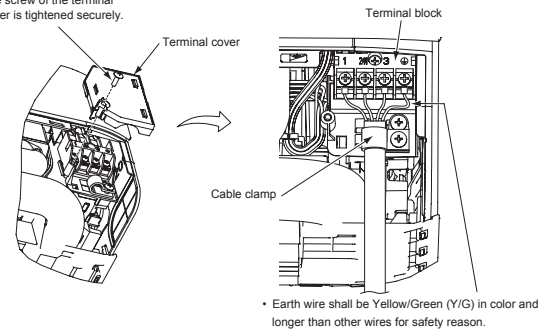

WARNING

Incorrect wiring connection can cause malfunction or fire.

6. FORMING PIPING AND DRAIN HOSE

1. Forming piping

Piping is possible in the right, rear, downward, left, left rear or left downward direction.

NOTE

Sufficient care must be taken not to damage the panels when connecting pipes.

Cut out the panel smoothly along the line in case of side or bottom piping.

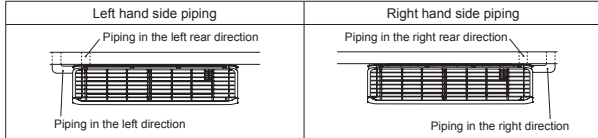
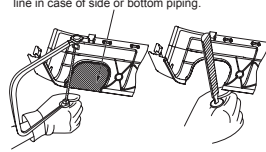
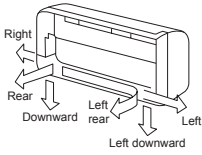

Forming of pipings

- Hold the bottom of the piping and fix direction before stretching it and shaping it.

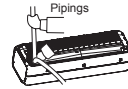

Taping of the exterior

- Tape only the portion that goes through the wall.
- Always tape the wiring with the piping.



2. Drain change procedures

- Remove the screw and drain hose.
- Remove the drain cap by hand or pliers.
- Insert the drain cap which was removed at procedure (2) securely using a hexagonal wrench etc.
- Install the drain hose and screw securely.

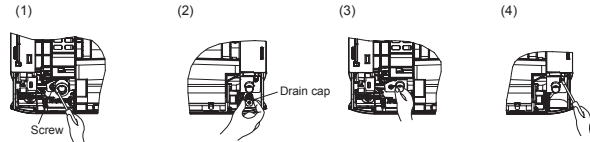

CAUTION

Incorrect installation of drain hose and cap can cause water leakage.

7. DRAINAGE WORK

- Arrange the drain hose in a downward angle.
- Avoid the following drain piping.

- Pour water to the drain pan located under the heat exchanger, and ensure that the water is discharged outdoor.
- When extended drain hose is present inside the room, insulate it securely with heat insulator available in the market.

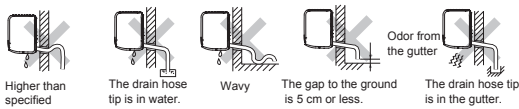

Since this air-conditioner is designed to collect dew drops on the rear surface to the drain pan, do not install the connecting wire above the gutter.

CAUTION

Incorrect drainage work can cause water leakage.

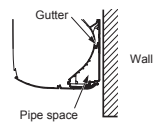

8. INSTALLING INDOOR UNIT

Installing the indoor unit to installation board

- Pass the pipe through the hole in the wall, and hook the upper part of the indoor unit to the installation board.



- Gently push the lower part to fix the indoor unit base lower latch to installation board.



- Install the latches of the bottom panel (7 locations). Secure the bottom panel with the 3 screws (in the cap).

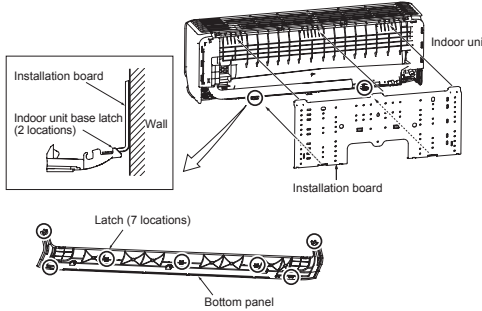

Removing the indoor unit from installation board

- Remove the bottom panel. (Refer to 5.2)
- Pull the indoor unit base latch downward. (both right and left hand sides). (The indoor unit base latch can be removed from the installation board.)
- Push up the indoor unit upward so that it can be removed from installation board.

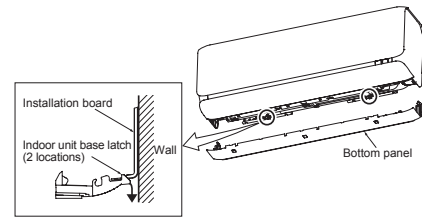

9. CONNECTING PIPING WORK

1. Preparation of connecting pipe

1.1. Selecting connecting pipe

Select connecting pipe according to the following table.

	Model SRK20/25/35	Model SRK50/60
Gas pipe	φ 9.52	φ 12.7
Liquid pipe	φ 6.35	φ 6.35

- Pipe wall thickness must be greater than or equal to 0.8 mm.
- Pipe material must be O-type (Phosphorus deoxidized seamless copper pipe ICS 23.040.15, ICS 77.150.30).

1.2. Cutting connecting pipe

- Cut the connecting pipe to the required length with pipe cutter.
- Hold the pipe downward and remove the burrs. Make sure that no foreign material enters the pipe.
- Cover the connecting pipe ends with the tape.

2. Piping work

2.1. Flaring pipe

- Take out flare nuts from the service valves of indoor unit and engage them onto connecting pipes.
- Flare the pipes according to table and figure shown below.

Copper pipe outer diameter	A ₀ -0.4	Copper pipe outer diameter	
		R32 or R410A	Conventional
φ 6.35	9.1	0-0.5	1.0-1.5
φ 9.52	13.2		
φ 12.7	16.6		

2.2 Connecting pipes

- Connect pipes on both liquid and gas sides.
- Tighten nuts to specified torque shown in the table below.

Service valve size (mm)	Tightening torque (N·m)
φ 6.35 (1/4")	14-18
φ 9.52 (3/8")	34-42
φ 12.7 (1/2")	49-61

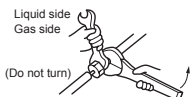

CAUTION

- Do not apply refrigerating machine oil to the flared surface. It can cause refrigerant leakage.
- Do not apply excess torque to the flared nuts. The flared nuts may crack resulting in refrigerant leakage.

3. Heating and condensation prevention

- Dress the connecting pipes (both liquid and gas pipes) with insulation to prevent it from heating and dew condensation. Use the heat insulating material which can withstand 120°C or higher temperature. Make sure that insulation is wrapped tightly around the pipes and no gap is left between them.
- Wrap the refrigerant pipings of indoor unit with indoor unit heat insulation using tape.
- Cover the flare-connected joints (indoor side) with the indoor unit heat insulation and wrap it with an insulation pad (standard accessory provided with indoor unit).
- Wrap the connecting pipes, connecting cable and drain hose with the tape.

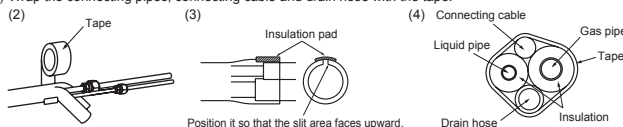

NOTE

Locations where relative humidity exceeds 70%, both liquid and gas pipes need to be dressed with 20mm or thicker heat insulation materials.

CAUTION

- Improper insulation can cause condensate(water) formation during cooling operation. Condensate can leak or drip causing damage to household property.
- Poor heat insulating capacity can cause pipe outer surface to reach high temperature during heating operation. It can cause cable deterioration and personal injury.

4. Finishing work

- Make sure that the exterior portion of connecting pipes, connecting cable and drain hose is wrapped properly with tape. Shape the connecting pipes to match with the contours of the pipe assembly route.
- Fix the pipe assembly with the wall using clamps and screws. Pipe assembly should be anchored every 1.5m or less to isolate the vibration.
- Install the service cover securely. Water may enter the unit if service cover is not installed properly, resulting in unit malfunction and failure.

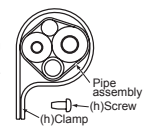

WARNING (only for R32)

- To avoid the risk of fire or explosion, the flared connection must/shall be installed outdoors.
- Reusable mechanical connectors and flared joints are not allowed indoors.

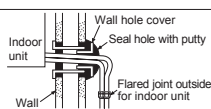

CAUTION

Make sure that the connecting pipes do not touch the components within the unit. If pipes touch the internal components, it may generate abnormal sounds and/or vibrations.

10. HOW TO OPEN, CLOSE, REMOVE AND INSTALL THE AIR INLET PANEL

1. Open
Pull the air inlet panel at both ends of lower part and release latches, then pull up the panel until you feel resistance. (The panel stops at approx. 60° open position)

2. Close
Hold the panel at both ends of lower part, lower it downward slowly, then push it slightly until the latch works.

3. Removing
Open the panel by 80° (as shown in the right illustration) and then pull it forward.

4. Installing
Insert the panel arm into the slot on the front panel from the position shown in right illustration, hold the panel at both ends of lower part, lower it downward slowly, then push it slightly until the latch works.

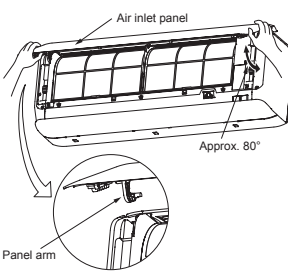

NOTE

- When carrying out maintenance, handle the air inlet panel with care.

11. HOW TO REMOVE AND INSTALL THE SIDE AND FRONT PANEL

1. Side panel (R/L)

1.1. Removing

- Remove the 2 screws.
- Remove the 3 latches and then side panel can be removed.

1.2. Installing

- Cover the unit with the side panel and fix 3 latches.
- Secure the side panel with the 2 screws.

2. Front panel

2.1. Removing

- Remove the side panel (R/L), the air inlet panel, the air filters and the bottom panel.
- Remove the 3 screws.
- Remove the 4 upper latches and then front panel can be removed.

2.2. Installing

- Cover the unit with the front panel and fix 4 upper latches.
- Secure the front panel with the 3 screws.
- Install the bottom panel, the side panel (R/L), the air inlet panel and the air filters.

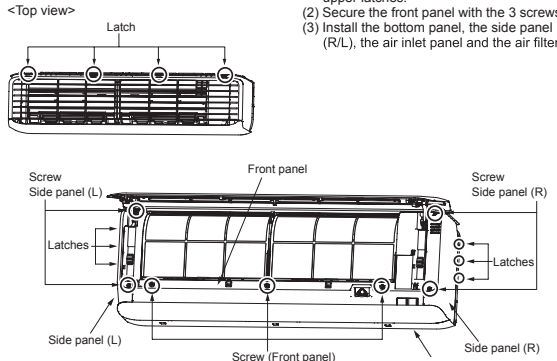

12. INSTALLING WIRELESS REMOTE CONTROL

Mount the batteries

- Slide and take out the cover of backside.
- Mount the batteries [R03 (AAA, Micro), ×2 pieces] in the body properly. (Fit it poles with the indication marks + & -)
- Set the cover again.

Installing remote control holder

- Select the place where the unit can receive signals.
- Fix the holder to pillar or wall with wood screws.

NOTE

- Do not use new and old batteries together.
- In case the unit is not operated for a long time, take out the batteries

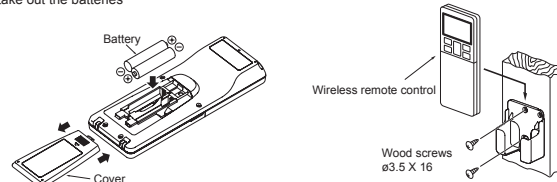

16. INSTALLATION CHECK AND TEST RUN

After finishing the installation work, check the following points again before turning on the power. Conduct a test run and ensure that the unit operates properly. At the same time, explain to the customer how to use the unit and how to take care of the unit following the user's manual.

Before test run

Before test run, check following points.

Power source voltage complies with the rated voltage of air-conditioner.	
Earth leakage breaker and circuit breaker are installed.	
Power cable and connecting cable are securely fixed to the terminal block.	
Both liquid and gas service valves are fully open.	
No gas leaks from the joints of the service valves.	
Indoor and outdoor side pipe joints have been insulated.	
Hole on the wall is completely sealed with putty.	
Drain hose and cap are installed properly.	
Screw of the terminal cover is tightened securely.	

Test run

Check following points during test run.

Indoor unit receives signal of wireless remote control.	
Air-conditioning operation is normal.	
There is no abnormal noise.	
Water drains out smoothly.	
Display of wireless remote control is normal.	

After test run

Explain the operating and maintenance methods to the user according to the user's manual.	
Keep this installation manual together with user's manual.	

NOTE

During restart or change in operation mode, the unit will not start operating for approximately 3 minutes. This is to protect the unit and it is not malfunction.

13. INSTALLING TWO AIR-CONDITIONERS IN THE SAME ROOM

In case two air-conditioners are installed in the same room, apply this setting so that one unit can be operated with only one wireless remote control.

Setting one wireless remote control

- Slide and take out the cover and batteries.
- Cut the switching line next to the battery with wire cutters.
- Set the batteries and cover again.

Setting one indoor unit

- Turn off the power source and turn it on after 1 minute.
- Send the signal by pressing the ACL switch on the wireless remote control that was set according to the procedure described on the above side.
- Check that the reception buzzer sound "Peep" is emitted from the indoor unit. Since the signal is sent about 6 seconds after the ACL switch is pressed, point the wireless remote control to the indoor unit for a while.

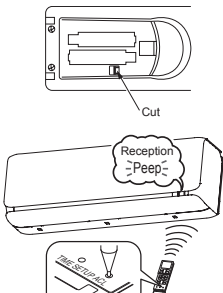

NOTE

If no reception buzzer is emitted, restart the setting from the beginning.

14. TERMINAL CONNECTION FOR AN INTERFACE

To install wired remote control, superlink etc., interface kit is needed.

- Remove the air inlet panel, bottom panel and side panel (R).
- Remove the control cover. (Remove the screw.)
- There is a terminal (respectively marked with CNS) for the indoor control board. While connecting an interface, connect to the respective terminal securely with the connection harness supplied with the option "Interface kit SC-BIKN-E and SC-BIKN2-E" and fasten the connection harness onto the indoor control box with the clamp and screw supplied with the kit.
- Hook to fix the interface kit to the 2 latches on side panel (L). For more details, refer to the user's manual of "Interface kit SC-BIKN-E and SC-BIKN2-E".

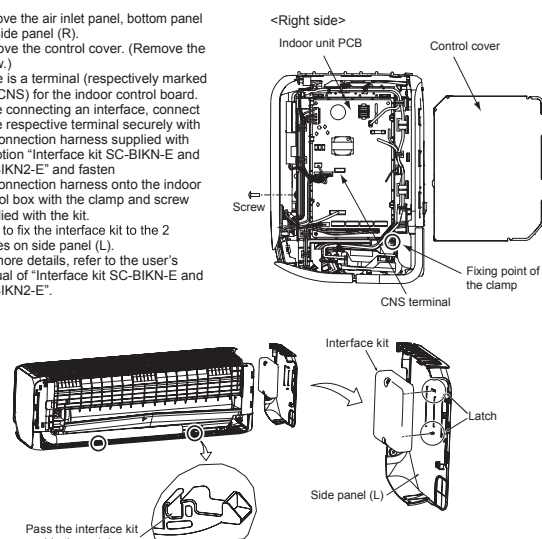

15. PUMP DOWN WORK

For the environmental protection, be sure to pump down when relocating or disposing of the unit. Pump down is the method of recovering refrigerant from the indoor unit to the outdoor unit before the connecting pipes are removed from the unit. When pump down is carried out, forced cooling operation is needed.

Forced cooling operation

- Turn off the power source and turn it on again after 1 minute. The air inlet panel and flap open and close.
- After the air inlet panel closes, press the ON/OFF button continuously for at least 5 seconds. Then operation will start.



For the detail of pump down, refer to the installation manual of outdoor unit.

(b) Models SRK20ZS, 25ZS, 35ZS, 50ZS

RLF012A105

Model SRK20,25,35,50ZS
R32/R410A REFRIGERANT USED

- This installation manual deals with an indoor unit installation only. For an outdoor unit installation, refer to page 9.
- This unit is designed for R32 or R410A. See a label on the outdoor unit to check refrigerant information.

SAFETY PRECAUTIONS

- Before installation, read the "SAFETY PRECAUTIONS" carefully and strictly follow it during the installation work in order to protect yourself.
- The precautionary items mentioned below are distinguished into two levels, **WARNING** and **CAUTION**.
 - WARNING** Indicates a potentially hazardous situation which, if not avoided, can result in serious consequences such as death or severe injury.
 - CAUTION** Indicates a potentially hazardous situation which, if not avoided, can result in personal injury or property damage.
- Both mention the important items to protect your health and safety. Therefore, strictly follow them by any means.
- Be sure to confirm no operation problem on the equipment after completing the installation. If unusual noise can be heard during the test run, consult the dealer.
- Be sure to explain the operating methods as well as the maintenance methods of this equipment to the user according to the user's manual.
- Be sure to keep the installation manual together with user's manual at a place where it is easily accessible to the user any time. Moreover, ask the user to hand the manuals to a new user, whenever required.

WARNING

- **Be sure to use only for residential purpose.**
If this unit is installed in inferior environment such as machine shop, vehicle (like ship), warehouse, etc., it can malfunction.
- **Installation must be carried out by the qualified installer completely in accordance with the installation manual.**
Installation by non qualified person or incorrect installation can cause serious troubles such as water leak, electric shock, fire and personal injury.
- **Be sure to wear protective goggles and gloves while performing installation work.**
Improper safety measures can result in personal injury.
- **Use the original accessories and the specified components for the installation.**
Using parts other than those prescribed may cause water leak, electric shock, fire and personal injury.
- **Do not install the unit near the location where leakage of inflammable gases can occur.**
If leaked gases accumulate around the unit, it can cause fire resulting in property damage and personal injury.
- **When installing the unit in small rooms, make sure that refrigerant density does not exceed the limit (Reference: ISO5149) in the event of leakage.**
If refrigerant density exceeds the limit, consult the dealer and install the ventilation system. Otherwise lack of oxygen can occur resulting in serious accident.
- **Install the unit in a location where unit will remain stable, horizontal and free of any vibration transmission.**
Unsuitable installation location can cause the unit to fall resulting in material damage and personal injury.
- **Do not run the unit with removed panels or protections.**
Touching rotating equipments, hot surfaces or high voltage parts can cause personal injury due to entrapment, burn or electric shock.
- **This unit is designed specifically for R32 or R410A.**
Using any other refrigerant can cause unit failure and personal injury.
- **Do not vent R32 or R410A into atmosphere.**
R32 is a fluorinated greenhouse gas with a Global Warming Potential(GWP)=675.
R410A is a fluorinated greenhouse gas with a Global Warming Potential(GWP)=2088.
- **Make sure that no air enters the refrigerant circuit when the unit is installed and removed.**
If air enters the refrigerant circuit, the pressure in the refrigerant circuit will become too high, which can cause burst and personal injury.
- **Be sure to use the prescribed pipes, flare nuts and tools for R32 or R410A.**
Using existing parts (for R22 or R407C) can cause refrigerant circuit burst resulting in unit failure and personal injury.
- **Be sure to connect both liquid and gas connecting pipes properly before operating the compressor.**
Do not open the liquid and gas operation valves before completing piping work, and evacuation.
If the compressor is operated when connecting pipes are not connected and operation valves are open, air can be sucked into the refrigerant circuit which can cause anomalous high pressure resulting in burst or personal injury.
- **Be sure to tighten the flare nuts to specified torque using the torque wrench.**
Tightening flare nuts with excess torque can cause burst and refrigerant leakage after a long period.
- **During pump down work, be sure to stop the compressor before closing operation valves and removing connecting pipes.**
If the connecting pipes are removed when the compressor is in operation and operation valves are open, air can be sucked into the refrigerant circuit which can cause anomalous high pressure resulting in burst or personal injury.
- **In the event of refrigerant leakage during installation, be sure to ventilate the working area properly.**
If the refrigerant comes into contact with naked flames, poisonous gases will be produced.
- **Electrical work must be carried out by the qualified electrician, strictly in accordance with national or regional electricity regulations.**
Incorrect installation can cause electric shock, fire or personal injury.
- **Make sure that earth leakage breaker and circuit breaker of appropriate capacities are installed.**
Circuit breaker should be able to disconnect all poles under over current. Absence of appropriate breakers can cause electric shock, personal injury or property damage.
- **Be sure to switch off the power source in the event of installation, maintenance or service.**
If the power source is not switched off, there is a risk of electric shock, unit failure or personal injury.
- **Be sure to tighten the cables securely in terminal block and relieve the cables properly to prevent overloading the terminal blocks.**
Loose connections or cable mountings can cause anomalous heat production or fire.
- **Do not process, splice or modify the power cable, or share the socket with other power plugs.**
Improper power cable or power plug can cause fire or electric shock due to poor connection, insufficient insulation or over-current.
- **Do not perform any change in protective device or its setup condition yourself.**
Changing protective device specifications can cause electric shock, fire or burst.
- **Be sure to clamp the cables properly so that they do not touch any internal component of the unit.**
If cables touch any internal component, it can cause overheating and fire.
- **Be sure to install service cover properly.**
Improper installation can cause electric shock or fire due to intrusion of dust or water.
- **Be sure to use the prescribed power and connecting cables for electrical work.**
Using improper cables can cause electric leak or fire.
- **This appliance must be connected to main power source by means of a circuit breaker or switch with a contact separation of at least 3mm.**
Improper electrical work can cause unit failure or personal injury.
- **When plugging this unit, a plug conforming to the standard IEC60884-1 must be used.**
Using improper plug can cause electric shock or fire.
- **Be sure to connect the power source cable with power source properly.**
Improper connection can cause intrusion of dust or water resulting in electric shock or fire.

CAUTION

- **Take care when carrying the unit by hand.**
If the unit weight is more than 20kg, it must be carried by two or more persons.
Do not carry the unit by the plastic straps. Always use the carry handle.
- **Do not install the outdoor unit in a location where insects and small animals can inhabit.**
Insects and small animals can enter the electrical parts and cause damage resulting in fire or personal injury. Instruct the user to keep the surroundings clean.
- **If the outdoor unit is installed at height, make sure that there is enough space for installation, maintenance and service.**
Insufficient space can result in personal injury due to falling from the height.
- **Do not install the unit near the location where neighbours are bothered by noise or air generating from the unit.**
It can affect surrounding environment and cause a claim.
- **Do not install in the locations where unit is directly exposed to corrosive gases (like sulphide gas, chloride gas), sea breeze or salty atmosphere.**
It can cause corrosion of heat exchanger and damage to plastic parts.
- **Do not install the unit close to the equipments that generate electromagnetic waves and/or high-harmonic waves.**
Equipment such as inverters, standby generators, medical high frequency equipments and telecommunication equipments can affect the system, and cause malfunctions and breakdowns.
The system can also affect medical equipment and telecommunication equipment, and obstruct its function or cause jamming.
- **Do not install the unit in the locations where:**
 - There are heat sources nearby.
 - Unit is directly exposed to rain or sunlight.
 - There is any obstacle which can prevent smooth air circulation from inlet and outlet side of the unit.
 - Unit is directly exposed to oil mist and steam such as kitchen.
 - Chemical substances like ammonia (organic fertilizer), calcium chloride (snow melting agent) and acid (sulfurous acid etc.), which can harm the unit, will generate or accumulate.
 - Drain water can not be discharged properly.
 - TV set or radio receiver is placed within 1m.
 - Height above sea level is more than 1000m.
- **Dispose of all packing materials properly.**
Packing materials contain nails and wood which can cause personal injury.
Keep the polybag away from children to avoid the risk of suffocation.
- **Do not put anything on the outdoor unit.**
Object may fall causing property damage or personal injury.
- **Do not touch the aluminum fin of the outdoor unit.**
Aluminium fin temperature is high during heating operation. Touching fin can cause burn.
- **Do not touch any refrigerant pipe with your hands when the system is in operation.**
During operation the refrigerant pipes become extremely hot or extremely cold depending on the operating condition. Touching pipes can cause personal injury like burn (hot/cold).
- **Install isolator or disconnect switch on the power source wiring in accordance with the local codes and regulations.**
The isolator should be locked in OFF state in accordance with EN60204-1.

1. ACCESSORIES AND TOOLS

Standard accessories (supplied with indoor unit)				Locally procured parts		Tools for installation work	
(1) Installation board		1pc.	(6) Batteries [R03 (AAA, Micro) 1.5V]		2pcs.	Plus headed driver	Hole core drill (65mm in diameter)
(2) Remote control		1pc.	(7) Air-cleaning filters		2pcs.	Knife	Wrench key (Hexagon) [4mm]
(3) Remote control holder		1pc.	(8) Filter holders		2pcs.	Saw	Flaring tool set*
(4) Tapping screws (for installation board φ4 X 25mm)		5pcs.	(9) Insulation (#486 50 X 100 t3)		1pc.	Tape measure	Gas leak detector*
(5) Wood screws (for remote control holder φ3.5 X 16mm)		2pcs.				Torque wrench (14.0-62.0N·m (1.4-6.2kgf·m))	Pipe bender
						Plier	Gauge for projection adjustment (Used when flare is made by using conventional flare tool)
						Pipe cutter	
							* Designed specifically for R32 or R410A

2. SELECTING INSTALLATION LOCATION

After getting customer's approval, select installation location according to following guidelines.

1. Indoor unit

- Where there is no obstruction to the airflow and where the cooled and heated air can be evenly distributed.
- A solid place where the unit or the wall will not vibrate.
- A place where there will be enough space for servicing. (Where space mentioned on the right side can be secured.)
- Where it is easy to conduct wiring and piping work.
- A place where unit is not directly exposed to sunlight or street light.
- A place where it can be easily drained.
- A place separated at least 1m away from the television or the radio. (To prevent interference to images and sounds.)
- A place where this unit is not affected by the high frequency equipment or electric equipment.
- Avoid installing this unit in place where there is much oil mist.
- A place where there is no electric equipment or household.
- Install the indoor unit on the wall where the height from the floor to the bottom of the unit is more than 180 cm.

2. Remote control

- A place where the air-conditioner can receive the signal surely during operating the remote control.
- A place where it is not affected by the TV, radio etc.
- Do not place where it is exposed to direct sunlight or near heat devices such as a stove.

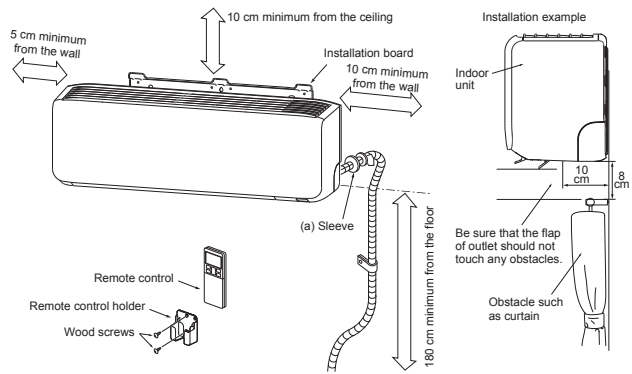

3. INSTALLING INSTALLATION BOARD

- Installation board should be installed on the wall which can support the weight of the indoor unit.
- Adjustment of the installation board in the horizontal direction is to be conducted with five screws in a temporary tightened state.
- With the standard hole as a center, adjust the board and level it.

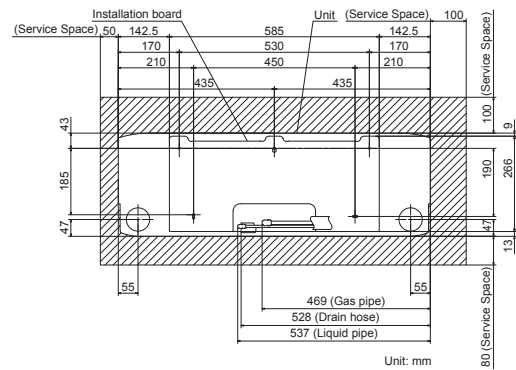
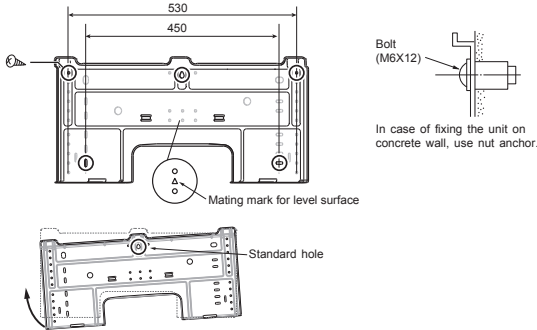

CAUTION
Improper adjustment of the installation board can cause water leakage.

4. DRILLING HOLE AND FIXTURE OF SLEEVE

When drilling the wall that contains a metal lath, wire lath or metal plate, be sure to use sealing plate, sleeve and inclination plate (Locally procured parts).

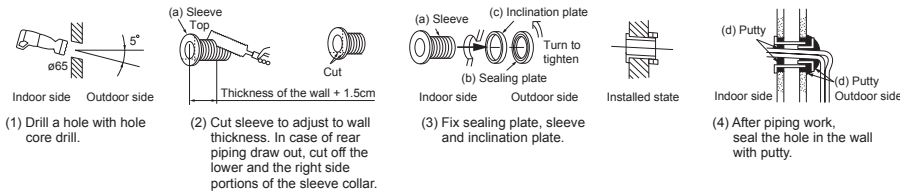

WARNING
Completely seal the hole in the wall with putty. If not sealed properly, dust, insects, small animals, and highly humid air may enter the room from outside, which could result in fire or other hazards.

CAUTION
Completely seal the hole in the wall with putty. If not sealed properly, furniture and other fixtures may be damaged by water leakage or condensation.

5. ELECTRICAL WIRING WORK

- Before installation, make sure that the power source complies with the air-conditioner's power specification.
- Carry out electrical wiring work according to following guidelines.

1. Preparing cable

- (1) Selecting cable
Select the connecting cable in accordance with the specifications mentioned below.
4-core* 1.5mm² conformed with 60245 IEC57
* 1 Earth wire is included (Yellow/Green).
- (2) Arrange each wire length as shown below.
Make sure that each wire is stripped 10mm from the end.

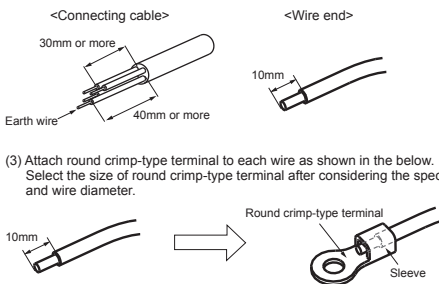

- (3) Attach round crimp-type terminal to each wire as shown in the below.
Select the size of round crimp-type terminal after considering the specifications of terminal block and wire diameter.

2. Connecting cable

- (1) Open the air inlet panel.
- (2) Remove the lid.
- (3) Remove the cable clamp.
- (4) Connect the connecting wires to the terminal block.
- (5) Fix the connecting cable by cable clamp.
- (6) Fix the lid.
- (7) Close the air inlet panel.

NOTE

Take care not to confuse the terminal numbers for indoor and outdoor connections.

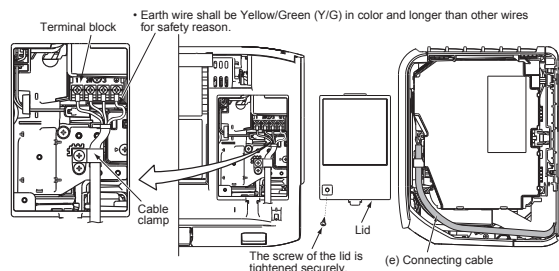

WARNING
Incorrect wiring connection can cause malfunction or fire.

6. FORMING PIPING AND DRAIN HOSE

1. Forming piping

Piping is possible in the right, rear, downward, left, left rear or left downward direction.

NOTE

Sufficient care must be taken not to damage the panels when connecting pipes.

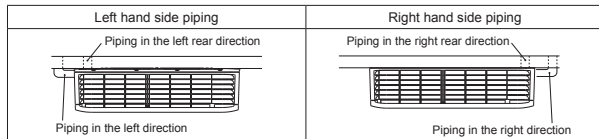
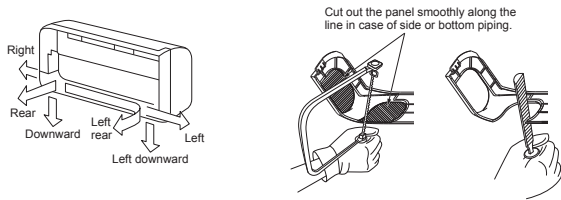

Forming of pipings.

- Hold the bottom of the piping and fix direction before stretching it and shaping it.

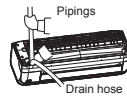

Taping of the exterior

- Tape only the portion that goes through the wall.
- Always tape the wiring with the piping.



2. Drain change procedures

- (1) Remove the screw and drain hose.
- (2) Remove the drain cap by hand or pliers.
- (3) Insert the drain cap which was removed at procedure (2) securely using a hexagonal wrench etc.
- (4) Install the drain hose and screw securely.

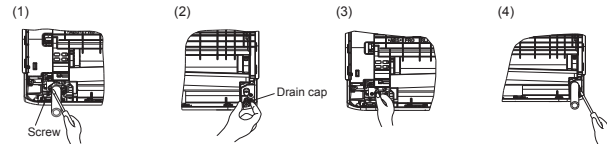

CAUTION

Incorrect installation of drain hose and cap can cause water leakage.

7. DRAINAGE WORK

- Arrange the drain hose in a downward angle.
- Avoid the following drain piping.

- Pour water to the drain pan located under the heat exchanger, and ensure that the water is discharged outdoor.
- When extended drain hose is present inside the room, insulate it securely with heat insulator available in the market.

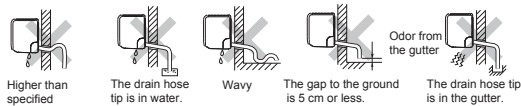

Since this air-conditioner is designed to collect dew drops on the rear surface to the drain pan, do not install the connecting wire above the gutter.

CAUTION

Incorrect drainage work can cause water leakage.

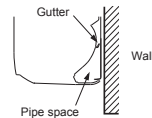

8. INSTALLING INDOOR UNIT

Installing the indoor unit to installation board

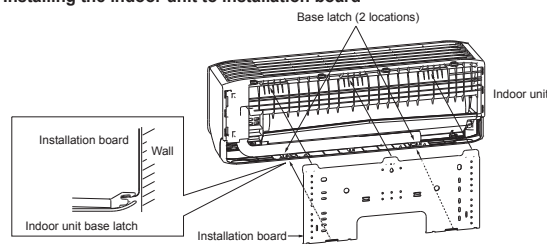

- (1) Pass the pipe through the hole in the wall, and hook the upper part of the indoor unit to the installation board.
- (2) Gently push the lower part to fix the indoor unit base lower latch to installation board.

Removing the indoor unit from installation board

- (1) Push up at the marked portion of the indoor unit base latch, and slightly pull it toward you (both right and left hand sides). (The indoor unit base latch can be removed from the installation board.)
- (2) Push up the indoor unit upward so that it can be removed from installation board.

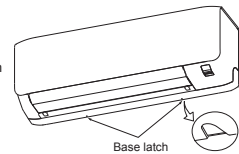

9. CONNECTING PIPING WORK

1. Preparation of connecting pipe

1.1. Selecting connecting pipe

Select connecting pipe according to the following table.

	Model SRK20/25/35	Model SRK50
Gas pipe	φ 9.52	φ 12.7
Liquid pipe	φ 6.35	φ 6.35

- Pipe wall thickness must be greater than or equal to 0.8 mm.
- Pipe material must be O-type (Phosphorus deoxidized seamless copper pipe ICS 23.040.15, ICS 77.150.30).

1.2. Cutting connecting pipe

- (1) Cut the connecting pipe to the required length with pipe cutter.
- (2) Hold the pipe downward and remove the burrs. Make sure that no foreign material enters the pipe.
- (3) Cover the connecting pipe ends with the tape.

2. Piping work

2.1. Flaring pipe

- (1) Take out flare nuts from the service valves of indoor unit and engage them onto connecting pipes.
- (2) Flare the pipes according to table and figure shown below.
Flare dimensions for R32 are different from those for conventional refrigerant. Although it is recommended to use the flaring tools designed specifically for R32 or R410A, conventional flaring tools can also be used by adjusting the dimension B with a flare adjustment gauge.

Copper pipe outer diameter	A	B [Rigid (clutch) type]	
		R32 or R410A	Conventional
φ6.35	9.1	0-0.5	1.0-1.5
φ9.52	13.2		
φ12.7	16.6		

2.2 Connecting pipes

- (1) Connect pipes on both liquid and gas sides.
- (2) Tighten nuts to specified torque shown in the table below.

Service valve size (mm)	Tightening torque (N·m)
φ 6.35 (1/4")	14-18
φ 9.52 (3/8")	34-42
φ 12.7 (1/2")	49-61

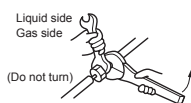

3. Heating and condensation prevention

- (1) Dress the connecting pipes (both liquid and gas pipes) with insulation to prevent it from heating and dew condensation.

Use the heat insulating material which can withstand 120°C or higher temperature. Make sure that insulation is wrapped tightly around the pipes and no gap is left between them.

- (2) Wrap the refrigerant pipings of indoor unit with indoor unit heat insulation using tape.
- (3) Cover the flare-connected joints (indoor side) with the indoor unit heat insulation and wrap it with an insulation pad (standard accessory provided with indoor unit)

- (4) Wrap the connecting pipes, connecting cable and drain hose with the tape.

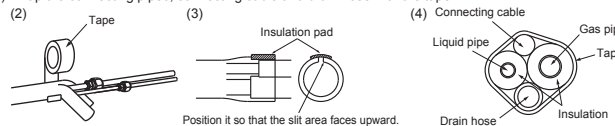

NOTE

Locations where relative humidity exceeds 70%, both liquid and gas pipes need to be dressed with 20mm or thicker heat insulation materials.

CAUTION

- Improper insulation can cause condensate(water) formation during cooling operation. Condensate can leak or drip causing damage to household property.
- Poor heat insulating capacity can cause pipe outer surface to reach high temperature during heating operation. It can cause cable deterioration and personal injury.

4. Finishing work

- (1) Make sure that the exterior portion of connecting pipes, connecting cable and drain hose is wrapped properly with tape. Shape the connecting pipes to match with the contours of the pipe assembly route.
- (2) Fix the pipe assembly with the wall using clamps and screws. Pipe assembly should be anchored every 1.5m or less to isolate the vibration.
- (3) Install the service cover securely. Water may enter the unit if service cover is not installed properly, resulting in unit malfunction and failure.

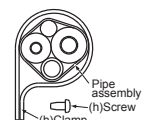

WARNING (only for R32)

- To avoid the risk of fire or explosion, the flared connection must/shall be installed outdoors.
- Reusable mechanical connectors and flared joints are not allowed indoors.

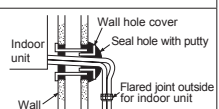

CAUTION

Make sure that the connecting pipes do not touch the components within the unit. If pipes touch the internal components, it may generate abnormal sounds and/or vibrations.

10. HOW TO OPEN, CLOSE, REMOVE AND INSTALL THE AIR INLET PANEL

1. Open
Pull the air inlet panel at both ends of lower part and release latches, then pull up the panel until you feel resistance.
(The panel stops at approx. 70° open position)

2. Close
Hold the panel at both ends of lower part, lower it downward slowly, then push it slightly until the latch works.

3. Removing
Open the panel by 90° (as shown in the right illustration) and then pull it forward.

4. Installing
Insert the panel arm into the slot on the front panel from the position shown in right illustration, hold the panel at both ends of lower part, lower it downward slowly, then push it slightly until the latch works.

11. HOW TO REMOVE AND INSTALL THE BOTTOM AND FRONT PANEL

1. Bottom panel

1.1. Removing
(1) Remove the 2 screws (in the cap).
(2) Remove the 2 hooks of left and right side and then bottom panel can be removed.

1.2. Installing
(1) Install the 2 hooks of left and right side.
(2) Secure the bottom panel with the 2 screws (in the cap).

2. Front panel

2.1. Removing
(1) Remove the air inlet panel, the air filters and the bottom panel.
(2) Remove the 2 screws.
(3) Remove the 4 upper latches and then front panel can be removed.

2.2. Installing
(1) Cover the unit with the front panel and fix 4 upper latches.
(2) Secure the front panel with the 2 screws.
(3) Install the bottom panel, the air inlet panel and the air filters.

12. INSTALLING REMOTE CONTROL

Mount the batteries
(1) Slide and take out the cover of backside.
(2) Mount the batteries [R03 (AAA, Micro), ×2 pieces] in the body properly.
(Fit the poles with the indication marks + & -)
(3) Set the cover again.

Installing remote control holder
(1) Select the place where the unit can receive signals.
(2) Fix the holder to pillar or wall with wood screws.

NOTE
• Do not use new and old batteries together.
• In case the unit is not operated for a long time, take out the batteries

13. TERMINAL CONNECTION FOR AN INTERFACE

To install wired remote control, superlink etc., interface kit is needed.

(1) Remove the air inlet panel, bottom panel and front panel.
(2) Remove the control cover. (Remove the screw.)
(3) There is a terminal (respectively marked with CNS) for the indoor control board. While connecting an interface, connect to the respective terminal securely with the connection harness supplied with an optional "Interface connection kit SC-BIKN-E and SC-BIKN2-E" and fasten the connection harness onto the indoor control box with the clamp and screw supplied with the kit.

For more details, refer to the user's manual of "Interface connection kit SC-BIKN-E and SC-BIKN2-E".

14. INSTALLING TWO AIR-CONDITIONERS IN THE SAME ROOM

In case two air-conditioners are installed in the same room, apply this setting so that one unit can be operated with only one remote control.

Setting one remote control
(1) Slide and take out the cover and batteries.
(2) Cut the switching line next to the battery with wire cutters.
(3) Set the batteries and cover again.

Setting one indoor unit
(1) Turn off the power source and turn it on after 1 minute.
(2) Send the signal by pressing the ACL switch on the remote control that was set according to the procedure described on the left side.
(3) Check that the reception buzzer sound "peep" is emitted from the indoor unit. Since the signal is sent about 6 seconds after the ACL switch is pressed, point the remote control to the indoor unit for a while.

NOTE
If no reception buzzer is emitted, restart the setting from the beginning.

15. PUMP DOWN WORK

For the environmental protection, be sure to pump down when relocating or disposing of the unit. Pump down is the method of recovering refrigerant from the indoor unit to the outdoor unit before the connecting pipes are removed from the unit. When pump down is carried out, forced cooling operation is needed.

Forced cooling operation
(1) Turn off the power source and turn it on again after 1 minute.
(2) Press the ON/OFF button continuously for at least 5 seconds. Then operation will start.

For the detail of pump down, refer to the installation manual of outdoor unit.

16. INSTALLATION CHECK AND TEST RUN

After finishing the installation work, check the following points again before turning on the power. Conduct a test run and ensure that the unit operates properly. At the same time, explain to the customer how to use the unit and how to take care of the unit following the user's manual.

Before test run
Before test run, check following points.

Power source voltage complies with the rated voltage of air-conditioner.	
Earth leakage breaker and circuit breaker are installed.	
Power cable and connecting cable are securely fixed to the terminal block.	
Both liquid and gas service valves are fully open.	
No gas leaks from the joints of the service valves.	
Indoor and outdoor side pipe joints have been insulated.	
Hole on the wall is completely sealed with putty.	
Drain hose and cap are installed properly.	
Screw of the lid is tightened securely.	

Test run
Check following points during test run.

Indoor unit receives signal of remote control.	
Air-conditioning operation is normal.	
There is no abnormal noise.	
Water drains out smoothly.	
Display of remote control is normal.	

After test run

Explain the operating and maintenance methods to the user according to the user's manual.	
Keep this installation manual together with user's manual.	

NOTE
During restart or change in operation mode, the unit will not start operating for approximately 3 minutes. This is to protect the unit and it is not malfunction.

(c) Models SRK71ZR, 80ZR

RLD012A018 ⚠

Model SRK71, 80ZR
R32/R410A REFRIGERANT USED

- This installation manual deals with an indoor unit installation only. For an outdoor unit installation, refer to page 9.
- This unit is designed for R32 or R410A. See a label on the outdoor unit to check refrigerant information.

SAFETY PRECAUTIONS

- Before installation, read the "SAFETY PRECAUTIONS" carefully and strictly follow it during the installation work in order to protect yourself.
 - The precautionary items mentioned below are distinguished into two levels, **⚠ WARNING** and **⚠ CAUTION**.
 - ⚠ WARNING** Indicates a potentially hazardous situation which, if not avoided, can result in serious consequences such as death or severe injury.
 - ⚠ CAUTION** Indicates a potentially hazardous situation which, if not avoided, can result in personal injury or property damage.
- Both mention the important items to protect your health and safety. Therefore, strictly follow them by any means.
- Be sure to confirm no operation problem on the equipment after completing the installation. If unusual noise can be heard during the test run, consult the dealer.
 - Be sure to explain the operating methods as well as the maintenance methods of this equipment to the user according to the user's manual.
 - Be sure to keep the installation manual together with user's manual at a place where it is easily accessible to the user any time. Moreover, ask the user to hand the manuals to a new user, whenever required.





⚠ WARNING

- **Be sure to use only for residential purpose.**
If this unit is installed in inferior environment such as machine shop, vehicle (like ship), warehouse, etc., it can malfunction.
- **Installation must be carried out by the qualified installer completely in accordance with the installation manual.**
Installation by non qualified person or incorrect installation can cause serious troubles such as water leak, electric shock, fire and personal injury.
- **Be sure to wear protective goggles and gloves while performing installation work.**
Improper safety measures can result in personal injury.
- **Use the original accessories and the specified components for the installation.**
Using parts other than those prescribed may cause water leak, electric shock, fire and personal injury.
- **Do not install the unit near the location where leakage of flammable gases can occur.**
If leaked gases accumulate around the unit, it can cause fire resulting in property damage and personal injury.
- **When installing the unit in small rooms, make sure that refrigerant density does not exceed the limit (Reference: ISO5149) in the event of leakage.**
If refrigerant density exceeds the limit, consult the dealer and install the ventilation system. Otherwise lack of oxygen can occur resulting in serious accident.
- **Install the unit in a location where unit will remain stable, horizontal and free of any vibration transmission.**
Unsuitable installation location can cause the unit to fall resulting in material damage and personal injury.
- **Do not run the unit with removed panels or protections.**
Touching rotating equipments, hot surfaces or high voltage parts can cause personal injury due to entrapment, burn or electric shock.
- **This unit is designed specifically for R32 or R410A.**
Using any other refrigerant can cause unit failure and personal injury.
- **Do not vent R32 or R410A into atmosphere.**
R32 is a fluorinated greenhouse gas with a Global Warming Potential(GWP)=675.
R410A is a fluorinated greenhouse gas with a Global Warming Potential(GWP)=2088.
- **Make sure that no air enters the refrigerant circuit when the unit is installed and removed.**
If air enters the refrigerant circuit, the pressure in the refrigerant circuit will become too high, which can cause burst and personal injury.
- **Be sure to use the prescribed pipes, flare nuts and tools for R32 or R410A.**
Using existing parts (for R22 or R407C) can cause refrigerant circuit burst resulting in unit failure and personal injury.
- **Be sure to connect both liquid and gas connecting pipes properly before operating the compressor.**
Do not open the liquid and gas operation valves before completing piping work, and evacuation.
If the compressor is operated when connecting pipes are not connected and operation valves are open, air can be sucked into the refrigerant circuit which can cause anomalous high pressure resulting in burst or personal injury.
- **Be sure to tighten the flare nuts to specified torque using the torque wrench.**
Tightening flare nuts with excess torque can cause burst and refrigerant leakage after a long period.
- **During pump down work, be sure to stop the compressor before closing operation valves and removing connecting pipes.**
If the connecting pipes are removed when the compressor is in operation and operation valves are open, air can be sucked into the refrigerant circuit which can cause anomalous high pressure resulting in burst or personal injury.
- **In the event of refrigerant leakage during installation, be sure to ventilate the working area properly.**
If the refrigerant comes into contact with naked flames, poisonous gases will be produced.
- **Electrical work must be carried out by the qualified electrician, strictly in accordance with national or regional electricity regulations.**
Incorrect installation can cause electric shock, fire or personal injury.
- **Make sure that earth leakage breaker and circuit breaker of appropriate capacities are installed.**
Circuit breaker should be able to disconnect all poles under over current. Absence of appropriate breakers can cause electric shock, personal injury or property damage.
- **Be sure to switch off the power source in the event of installation, maintenance or service.**
If the power source is not switched off, there is a risk of electric shock, unit failure or personal injury.
- **Be sure to tighten the cables securely in terminal block and relieve the cables properly to prevent overloading the terminal blocks.**
Loose connections or cable mountings can cause anomalous heat production or fire.
- **Do not process, splice or modify the power cable, or share the socket with other power plugs.**
Improper power cable or power plug can cause fire or electric shock due to poor connection, insufficient insulation or over-current.
- **Do not perform any change in protective device or its setup condition yourself.**
Changing protective device specifications can cause electric shock, fire or burst.
- **Be sure to clamp the cables properly so that they do not touch any internal component of the unit.**
If cables touch any internal component, it can cause overheating and fire.
- **Be sure to install service cover properly.**
Improper installation can cause electric shock or fire due to intrusion of dust or water.
- **Be sure to use the prescribed power and connecting cables for electrical work.**
Using improper cables can cause electric leak or fire.
- **This appliance must be connected to main power source by means of a circuit breaker or switch with a contact separation of at least 3mm.**
Improper electrical work can cause unit failure or personal injury.
- **When plugging this unit, a plug conforming to the standard IEC60884-1 must be used.**
Using improper plug can cause electric shock or fire.
- **Be sure to connect the power source cable with power source properly.**
Improper connection can cause intrusion of dust or water resulting in electric shock or fire.

⚠ CAUTION

- **Take care when carrying the unit by hand.**
If the unit weight is more than 20kg, it must be carried by two or more persons.
Do not carry the unit by the plastic straps. Always use the carry handle.
- **Do not install the outdoor unit in a location where insects and small animals can inhabit.**
Insects and small animals can enter the electrical parts and cause damage resulting in fire or personal injury. Instruct the user to keep the surroundings clean.
- **If the outdoor unit is installed at height, make sure that there is enough space for installation, maintenance and service.**
Insufficient space can result in personal injury due to falling from the height.
- **Do not install the unit near the location where neighbours are bothered by noise or air generating from the unit.**
It can affect surrounding environment and cause a claim.
- **Do not install in the locations where unit is directly exposed to corrosive gases (like sulphide gas, chloride gas), sea breeze or salty atmosphere.**
It can cause corrosion of heat exchanger and damage to plastic parts.
- **Do not install the unit close to the equipments that generate electromagnetic waves and/or high-harmonic waves.**
Equipment such as inverters, standby generators, medical high frequency equipments and telecommunication equipments can affect the system, and cause malfunctions and breakdowns.
The system can also affect medical equipment and telecommunication equipment, and obstruct its function or cause jamming.
- **Do not install the unit in the locations where:**
 - There are heat sources nearby.
 - Unit is directly exposed to rain or sunlight.
 - There is any obstacle which can prevent smooth air circulation from inlet and outlet side of the unit.
 - Unit is directly exposed to oil mist and steam such as kitchen.
 - Chemical substances like ammonia (organic fertilizer), calcium chloride (snow melting agent) and acid (sulfurous acid etc.), which can harm the unit, will generate or accumulate.
 - Drain water can not be discharged properly.
 - TV set or radio receiver is placed within 1m.
 - Height above sea level is more than 1000m.
 It can cause performance degradation, corrosion and damage of components, unit malfunction and fire.
- **Dispose of all packing materials properly.**
Packing materials contain nails and wood which can cause personal injury.
Keep the polybag away from children to avoid the risk of suffocation.
- **Do not put anything on the outdoor unit.**
Object may fall causing property damage or personal injury.
- **Do not touch the aluminum fin of the outdoor unit.**
Aluminium fin temperature is high during heating operation. Touching fin can cause burn.
- **Do not touch any refrigerant pipe with your hands when the system is in operation.**
During operation the refrigerant pipes become extremely hot or extremely cold depending on the operating condition. Touching pipes can cause personal injury like burn (hot/cold).
- **Install isolator or disconnect switch on the power source wiring in accordance with the local codes and regulations.**
The isolator should be locked in OFF state in accordance with EN60204-1.

1. ACCESSORIES AND TOOLS

Standard accessories (supplied with indoor unit)		Locally procured parts		Tools for installation work	
(1) Installation board	 1pc.	(a) Sleeve (1pc.)		Plus headed driver	Hole core drill (65mm in diameter)
(2) Remote control	 1pc.	(b) Sealing plate (1pc.)		Knife	Wrench key (Hexagon) [4mm]
(3) Remote control holder	 1pc.	(c) Inclination plate (1pc.)		Saw	Flaring tool set*
(4) Tapping screws (for installation board φ4 X 25mm)	 10pcs.	(d) Putty		Tape measure	Gas leak detector*
(5) Wood screws (for remote control holder φ3.5 X 16mm)	 2pcs.	(e) Connecting cable		Torque wrench (14.0-82.0N·m (1.4-8.2kgf·m))	Pipe bender
		(f) Drain hose (extension hose)		Plier	Gauge for projection adjustment (Used when flare is made by using conventional flare tool)
		(g) Piping cover (for insulation of connection piping)		Pipe cutter	
		(h) Clamp and screw (for finishing work)			
		(i) Electrical tape			

* Designed specifically for R32 or R410A

2. SELECTING INSTALLATION LOCATION

After getting customer's approval, select installation location according to following guidelines.

1. Indoor unit

- Where there is no obstruction to the airflow and where the cooled and heated air can be evenly distributed.
- A solid place where the unit or the wall will not vibrate.
- A place where there will be enough space for servicing. (Where space mentioned on the right side can be secured.)
- Where it is easy to conduct wiring and piping work.
- A place where unit is not directly exposed to sunlight or street light.
- A place where it can be easily drained.
- A place separated at least 1m away from the television or the radio. (To prevent interference to images and sounds.)
- A place where this unit is not affected by the high frequency equipment or electric equipment.
- Avoid installing this unit in place where there is much oil mist.
- A place where there is no electric equipment or household.
- Install the indoor unit on the wall where the height from the floor to the bottom of the unit is more than 180 cm.

2. Remote control

- A place where the air-conditioner can receive the signal surely during operating the remote control.
- A place where it is not affected by the TV, radio etc.
- Do not place where it is exposed to direct sunlight or near heat devices such as a stove.

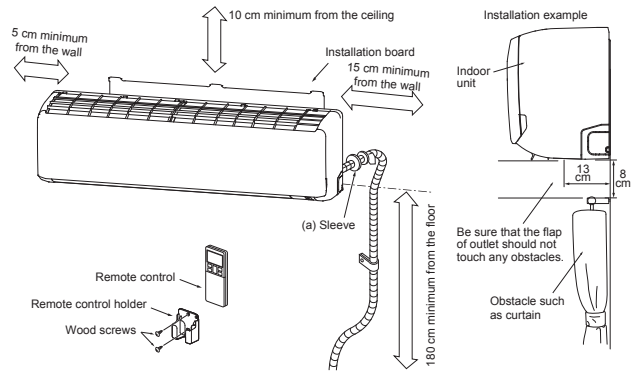

3. INSTALLING INSTALLATION BOARD

- Installation board should be installed on the wall which can support the weight of the indoor unit.
- Adjustment of the installation board in the horizontal direction is to be conducted with 8 screws in a temporary tightened state.
- With the standard hole as a center, adjust the board and level it.

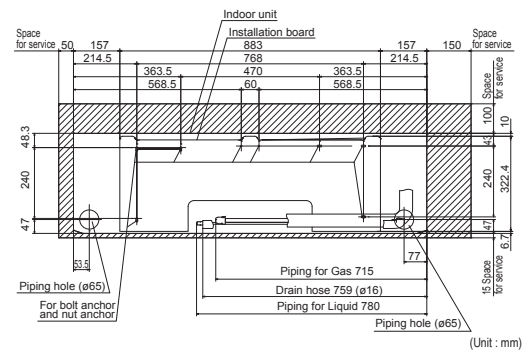
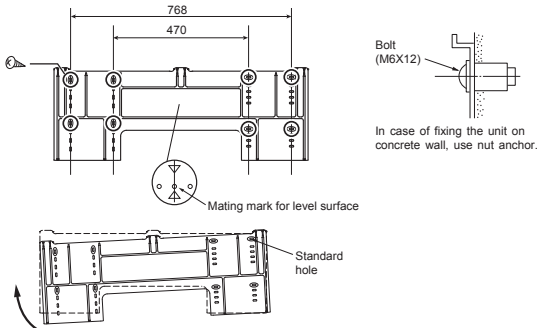

4. DRILLING HOLE AND FIXTURE OF SLEEVE

When drilling the wall that contains a metal lath, wire lath or metal plate, be sure to use sealing plate, sleeve and inclination plate (Locally procured parts).

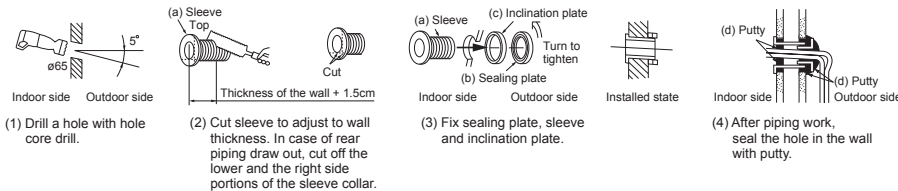

5. ELECTRICAL WIRING WORK

- Before installation, make sure that the power source complies with the air-conditioner's power specification.
- Carry out electrical wiring work according to following guidelines.

1. Preparing cable

- (1) Selecting cable
Select the connecting cable in accordance with the specifications mentioned below.
4-core* 1.5mm² conformed with 60245 IEC57
* 1 Earth wire is included (Yellow/Green).
- (2) Arrange each wire length as shown below.
Make sure that each wire is stripped 10mm from the end.

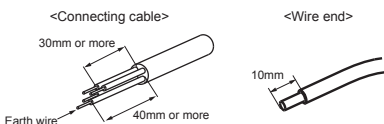

- (3) Attach round crimp-type terminal to each wire as shown in the below.
Select the size of round crimp-type terminal after considering the specifications of terminal block and wire diameter.

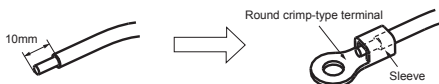

2. Connecting cable

- (1) Open the air inlet panel.
- (2) Remove the lid.
- (3) Remove the cable clamp.
- (4) Connect the connecting wires to the terminal block.
- (5) Fix the connecting cable by cable clamp.
- (6) Fix the lid.
- (7) Close the air inlet panel.

NOTE

Take care not to confuse the terminal numbers for indoor and outdoor connections.

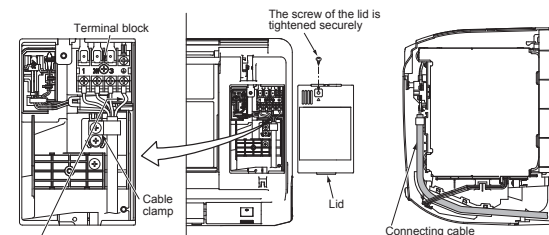

* Earth wire shall be Yellow/Green (Y/G) in color and longer than other AC wires for safety reason.

WARNING

Incorrect wiring connection can cause malfunction or fire.

6. FORMING PIPING AND DRAIN HOSE

1. Forming piping

Piping is possible in the right, rear, downward, left, left rear or left downward direction.

NOTE

Sufficient care must be taken not to damage the panels when connecting pipes.

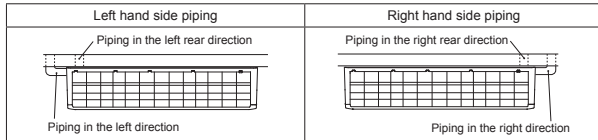
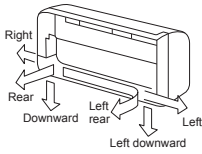

Forming of pipings.

- Hold the bottom of the piping and fix direction before stretching it and shaping it.

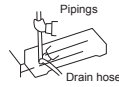

Taping of the exterior

- Tape only the portion that goes through the wall.
- Always tape the wiring with the piping.



2. Drain change procedures

- Remove the screw and drain hose.
- Remove the drain cap by hand or pliers.
- Insert the drain cap which was removed at procedure (2) securely using a hexagonal wrench etc.
- Install the drain hose and screw securely.

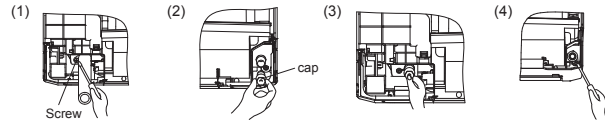

CAUTION

Incorrect installation of drain hose and cap can cause water leakage.

7. DRAINAGE WORK

- Arrange the drain hose in a downward angle.
- Avoid the following drain piping.

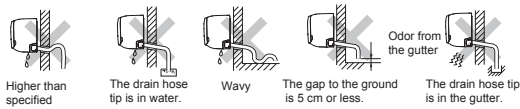

- Pour water to the drain pan located under the heat exchanger, and ensure that the water is discharged outdoor.
- When extended drain hose is present inside the room, insulate it securely with heat insulator available in the market.

Since this air-conditioner is designed to collect dew drops on the rear surface to the drain pan, do not install the connecting wire above the gutter.

CAUTION

Incorrect drainage work can cause water leakage.

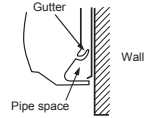

8. INSTALLING INDOOR UNIT

Installing the indoor unit to installation board

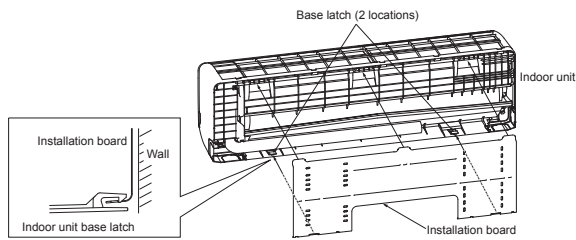

- Pass the pipe through the hole in the wall, and hook the upper part of the indoor unit to the installation board.



- Gently push the lower part to fix the indoor unit base lower latch to installation board.



Removing the indoor unit from installation board

- Push up at the marked portion of the indoor unit base latch, and slightly pull it toward you (both right and left hand sides). (The indoor unit base latch can be removed from the installation board.)
- Push up the indoor unit upward so that it can be removed from installation board.

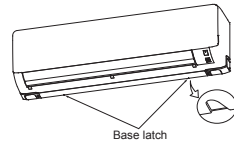

9. CONNECTING PIPING WORK

1. Preparation of connecting pipe

1.1. Selecting connecting pipe

Select connecting pipe according to the following table.

	Model SRK71, 80
Gas pipe	φ 15.88
Liquid pipe	φ 6.35

- Pipe wall thickness must be greater than or equal to 0.8 mm (φ 15.88:1.0mm).
- Pipe material must be O-type (Phosphorus deoxidized seamless copper pipe ICS 23.040.15, ICS 77.150.30).

1.2. Cutting connecting pipe

- Cut the connecting pipe to the required length with pipe cutter.
- Hold the pipe downward and remove the burrs. Make sure that no foreign material enters the pipe.
- Cover the connecting pipe ends with the tape.

2. Piping work

2.1. Flaring pipe

- Take out flare nuts from the operation valves of indoor unit and engage them onto connecting pipes.
 - Flare the pipes according to table and figure shown below.
- Flare dimensions for R32 are different from those for conventional refrigerant. Although it is recommended to use the flaring tools designed specifically for R32 or R410A, conventional flaring tools can also be used by adjusting the dimension B with a flare adjustment gauge.

Copper pipe outer diameter	A	B [Rigid (clutch) type]	
		R32 or R410A	Conventional
φ 6.35	9.1	0-0.5	1.0-1.5
φ 9.52	13.2		
φ 12.7	16.6		
φ 15.88	19.7		

2.2 Connecting pipes

- Connect pipes on both liquid and gas sides.
- Tighten nuts to specified torque shown in the table below.

Operation valve size (mm)	Tightening torque (N·m)
φ 6.35 (1/4")	14-18
φ 9.52 (3/8")	34-42
φ 12.7 (1/2")	49-61
φ 15.88 (5/8")	68-82

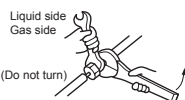

3. Heating and condensation prevention

- Dress the connecting pipes (both liquid and gas pipes) with insulation to prevent it from heating and dew condensation. Use the heat insulating material which can withstand 120°C or higher temperature. Make sure that insulation is wrapped tightly around the pipes and no gap is left between them.
- Wrap the refrigerant pipings of indoor unit with indoor unit heat insulation using tape.
- Cover the flare-connected joints (indoor side) with the indoor unit heat insulation and wrap it with an insulation pad (standard accessory provided with indoor unit).
- Wrap the connecting pipes, connecting cable and drain hose with the tape.

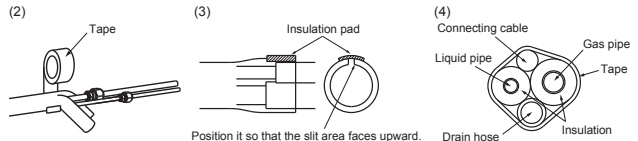

NOTE

Locations where relative humidity exceeds 70%, both liquid and gas pipes need to be dressed with 20mm or thicker heat insulation materials.

CAUTION

- Improper insulation can cause condensate(water) formation during cooling operation. Condensate can leak or drip causing damage to household property.
- Poor heat insulating capacity can cause pipe outer surface to reach high temperature during heating operation. It can cause cable deterioration and personal injury.

4. Finishing work

- Make sure that the exterior portion of connecting pipes, connecting cable and drain hose is wrapped properly with tape. Shape the connecting pipes to match with the contours of the pipe assembly route.
- Fix the pipe assembly with the wall using clamps and screws. Pipe assembly should be anchored every 1.5m or less to isolate the vibration.
- Install the service cover securely. Water may enter the unit if service cover is not installed properly, resulting in unit malfunction and failure.

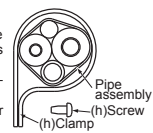

WARNING (only for R32)

- To avoid the risk of fire or explosion, the flared connection must/shall be installed outdoors.
- Reusable mechanical connectors and flared joints are not allowed indoors.

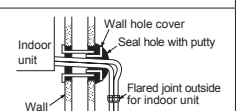

CAUTION

Make sure that the connecting pipes do not touch the components within the unit. If pipes touch the internal components, it may generate abnormal sounds and/or vibrations.

10. HOW TO OPEN, CLOSE, REMOVE AND INSTALL THE AIR INLET PANEL

1. Open

Pull the air inlet panel at both ends of lower part and release latches, then pull up the panel until you feel resistance.

(The panel stops at approx. 60° open position)

2. Close

Hold the panel at both ends of lower part, lower it downward slowly, then push it slightly until the latch works.

3. Removing

Open the panel by 80° (as shown in the right illustration) and then pull it forward.

4. Installing

Insert the panel arm into the slot on the front panel from the position shown in right illustration, hold the panel at both ends of lower part, lower it downward slowly, then push it slightly until the latch works.

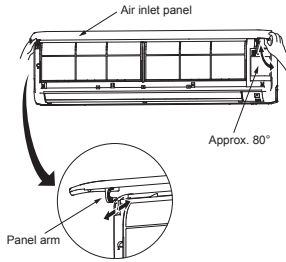

11. HOW TO REMOVE AND INSTALL FRONT PANEL

1. Removing

- (1) Remove the air inlet panel and the air filters.
- (2) Remove the 8 screws.
- (3) Remove the 5 upper latches and then front panel can be removed.

2. Installing

- (1) Cover the unit with the front panel and fix 5 upper latches.
- (2) Secure the front panel with the 8 screws.
- (3) Install the air inlet panel and the air filters.

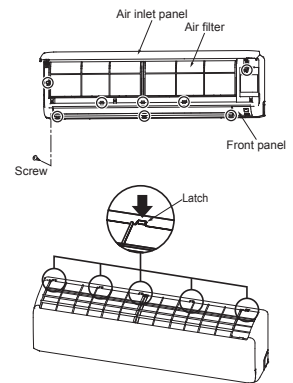

12. INSTALLING REMOTE CONTROL

Mount the batteries

- (1) Slide and take out the cover of backside.
- (2) Mount the batteries [R03 (AAA, Micro), ×2 pieces] in the body property.
(Fit the poles with the indication marks + & -)
- (3) Set the cover again.

NOTE

- Do not use new and old batteries together.
- In case the unit is not operated for a long time, take out the batteries

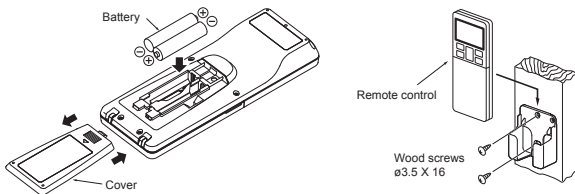

Installing remote control holder

- (1) Select the place where the unit can receive signals.
- (2) Fix the holder to pillar or wall with wood screws.

13. TERMINAL CONNECTION FOR AN INTERFACE

To install wired remote control, superlink etc., interface kit is needed.

- (1) Remove the air inlet panel and front panel.
- (2) Remove the control cover.
(Remove the screw.)
- (3) There is a terminal (respectively marked with CNS) for the indoor control board. While connecting an interface, connect to the respective terminal securely with the connection harness supplied with an optional "Interface connection kit SC-BIKN-E and SC-BIKN2-E" and fasten the connection harness onto the indoor control box with the clamp and screw supplied with the kit.
For more details, refer to the user's manual of "Interface connection kit SC-BIKN-E and SC-BIKN2-E".

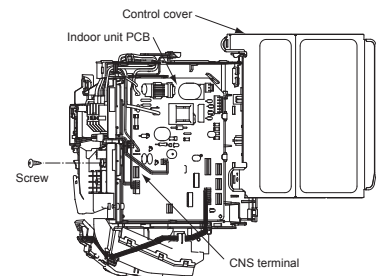

14. INSTALLING TWO AIR-CONDITIONERS IN THE SAME ROOM

In case two air-conditioners are installed in the same room, apply this setting so that one unit can be operated with only one remote control.

Setting one remote control

- (1) Slide and take out the cover and batteries.
- (2) Cut the switching line next to the battery with wire cutters.
- (3) Set the batteries and cover again.

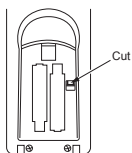

Setting one indoor unit

- (1) Turn off the power source and turn it on after 1 minute.
- (2) Send the signal by pressing the ACL switch on the remote control that was set according to the procedure described on the left side.
- (3) Check that the reception buzzer sound "peep" is emitted from the indoor unit. Since the signal is sent about 6 seconds after the ACL switch is pressed, point the remote control to the indoor unit for a while.

NOTE

If no reception buzzer is emitted, restart the setting from the beginning.

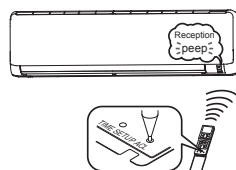

15. PUMP DOWN WORK

For the environmental protection, be sure to pump down when relocating or disposing of the unit. Pump down is the method of recovering refrigerant from the indoor unit to the outdoor unit before the connecting pipes are removed from the unit. When pump down is carried out, forced cooling operation is needed.

Forced cooling operation

- (1) Turn off the power source and turn it on again after 1 minute.
- (2) Press the ON/OFF button continuously for at least 5 seconds. Then operation will start.

For the detail of pump down, refer to the installation manual of outdoor unit.

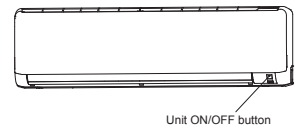

16. INSTALLATION CHECK AND TEST RUN

After finishing the installation work, check the following points again before turning on the power. Conduct a test run and ensure that the unit operates properly. At the same time, explain to the customer how to use the unit and how to take care of the unit following the user's manual.

Before test run

Before test run, check following points.

Power source voltage complies with the rated voltage of air-conditioner.	
Earth leakage breaker and circuit breaker are installed.	
Power cable and connecting cable are securely fixed to the terminal block.	
Both liquid and gas operation valves are fully open.	
No gas leaks from the joints of the operation valves.	
Indoor and outdoor side pipe joints have been insulated.	
Hole on the wall is completely sealed with putty.	
Drain hose and cap are installed properly.	
Screw of the lid is tightened securely.	

Test run

Check following points during test run.

Indoor unit receives signal of remote control.	
Air-conditioning operation is normal.	
There is no abnormal noise.	
Water drains out smoothly.	
Display of remote control is normal.	

After test run

Explain the operating and maintenance methods to the user according to the user's manual.	
Keep this installation manual together with user's manual.	

NOTE

During restart or change in operation mode, the unit will not start operating for approximately 3 minutes. This is to protect the unit and it is not malfunction.

(d) Models SKM20ZSP-W, 25ZSP-W, 35ZSP-W

RLC012A106

Model SKM20,25,35ZSP
R32/R410A REFRIGERANT USED

- This installation manual deals with an indoor unit installation only. For an outdoor unit installation, refer to page 9.
- This unit is designed for R32 or R410A. See a label on the outdoor unit to check refrigerant information.

SAFETY PRECAUTIONS

- Before installation, read the "SAFETY PRECAUTIONS" carefully and strictly follow it during the installation work in order to protect yourself.
 - The precautionary items mentioned below are distinguished into two levels, **WARNING** and **CAUTION**.
 - WARNING** Indicates a potentially hazardous situation which, if not avoided, can result in serious consequences such as death or severe injury.
 - CAUTION** Indicates a potentially hazardous situation which, if not avoided, can result in personal injury or property damage.
- Both mention the important items to protect your health and safety. Therefore, strictly follow them by any means.







WARNING

- **Be sure to use only for residential purpose.**
If this unit is installed in inferior environment such as machine shop, vehicle (like ship), warehouse, etc., it can malfunction.
- **Installation must be carried out by the qualified installer completely in accordance with the installation manual.**
Installation by non qualified person or incorrect installation can cause serious troubles such as water leak, electric shock, fire and personal injury.
- **Be sure to wear protective goggles and gloves while performing installation work.**
Improper safety measures can result in personal injury.
- **Use the original accessories and the specified components for the installation.**
Using parts other than those prescribed may cause water leak, electric shock, fire and personal injury.
- **Do not install the unit near the location where leakage of flammable gases can occur.**
If leaked gases accumulate around the unit, it can cause fire resulting in property damage and personal injury.
- **When installing the unit in small rooms, make sure that refrigerant density does not exceed the limit (Reference: ISO5149) in the event of leakage.**
If refrigerant density exceeds the limit, consult the dealer and install the ventilation system. Otherwise lack of oxygen can occur resulting in serious accident.
- **Install the unit in a location where unit will remain stable, horizontal and free of any vibration transmission.**
Unsuitable installation location can cause the unit to fall resulting in material damage and personal injury.
- **Do not run the unit with removed panels or protections.**
Touching rotating equipments, hot surfaces or high voltage parts can cause personal injury due to entrapment, burn or electric shock.
- **This unit is designed specifically for R32 or R410A.**
Using any other refrigerant can cause unit failure and personal injury.
- **Do not vent R32 or R410A into atmosphere.**
R32 is a fluorinated greenhouse gas with a Global Warming Potential (GWP) = 675.
R410A is a fluorinated greenhouse gas with a Global Warming Potential (GWP) = 2088.
- **Make sure that no air enters the refrigerant circuit when the unit is installed and removed.**
If air enters the refrigerant circuit, the pressure in the refrigerant circuit will become too high, which can cause burst and personal injury.
- **Be sure to use the prescribed pipes, flare nuts and tools for R32 or R410A.**
Using existing parts (for R22 or R407C) can cause refrigerant circuit burst resulting in unit failure and personal injury.
- **Be sure to connect both liquid and gas connecting pipes properly before operating the compressor.**
Do not open the liquid and gas operation valves before completing piping work, and evacuation.
If the compressor is operated when connecting pipes are not connected and operation valves are open, air can be sucked into the refrigerant circuit which can cause anomalous high pressure resulting in burst or personal injury.
- **Be sure to tighten the flare nuts to specified torque using the torque wrench.**
Tightening flare nuts with excess torque can cause burst and refrigerant leakage after a long period.
- **During pump down work, be sure to stop the compressor before closing operation valves and removing connecting pipes.**
If the connecting pipes are removed when the compressor is in operation and operation valves are open, air can be sucked into the refrigerant circuit which can cause anomalous high pressure resulting in burst or personal injury.
- **In the event of refrigerant leakage during installation, be sure to ventilate the working area properly.**
If the refrigerant comes into contact with naked flames, poisonous gases will be produced.
- **Electrical work must be carried out by the qualified electrician, strictly in accordance with national or regional electricity regulations.**
Incorrect installation can cause electric shock, fire or personal injury.
- **Make sure that earth leakage breaker and circuit breaker of appropriate capacities are installed.**
Circuit breaker should be able to disconnect all poles under over current. Absence of appropriate breakers can cause electric shock, personal injury or property damage.
- **Be sure to switch off the power source in the event of installation, maintenance or service.**
If the power source is not switched off, there is a risk of electric shock, unit failure or personal injury.
- **Be sure to tighten the cables securely in terminal block and relieve the cables properly to prevent overloading the terminal blocks.**
Loose connections or cable mountings can cause anomalous heat production or fire.
- **Do not process, splice or modify the power cable, or share the socket with other power plugs.**
Improper power cable or power plug can cause fire or electric shock due to poor connection, insufficient insulation or over-current.
- **Do not perform any change in protective device or its setup condition yourself.**
Changing protective device specifications can cause electric shock, fire or burst.
- **Be sure to clamp the cables properly so that they do not touch any internal component of the unit.**
If cables touch any internal component, it can cause overheating and fire.
- **Be sure to install service cover properly.**
Improper installation can cause electric shock or fire due to intrusion of dust or water.
- **Be sure to use the prescribed power and connecting cables for electrical work.**
Using improper cables can cause electric leak or fire.
- **This appliance must be connected to main power source by means of a circuit breaker or switch with a contact separation of at least 3 mm.**
Improper electrical work can cause unit failure or personal injury.
- **Be sure to connect the power source cable with power source properly.**
Improper connection can cause intrusion of dust or water resulting in electric shock or fire.

CAUTION

- **Take care when carrying the unit by hand.**
If the unit weight is more than 20 kg, it must be carried by two or more persons.
Do not carry the unit by the plastic straps. Always use the carry handle.
- **Do not install the outdoor unit in a location where insects and small animals can inhabit.**
Insects and small animals can enter the electrical parts and cause damage resulting in fire or personal injury. Instruct the user to keep the surroundings clean.
- **If the outdoor unit is installed at height, make sure that there is enough space for installation, maintenance and service.**
Insufficient space can result in personal injury due to falling from the height.
- **Do not install the unit near the location where neighbours are bothered by noise or air generating from the unit.**
It can affect surrounding environment and cause a claim.
- **Do not install in the locations where unit is directly exposed to corrosive gases (like sulphide gas, chloride gas), sea breeze or salty atmosphere.**
It can cause corrosion of heat exchanger and damage to plastic parts.
- **Do not install the unit close to the equipments that generate electromagnetic waves and/or high-harmonic waves.**
Equipment such as inverters, standby generators, medical high frequency equipments and telecommunication equipments can affect the system, and cause malfunctions and breakdowns. The system can also affect medical equipment and telecommunication equipment, and obstruct its function or cause jamming.
- **Do not install the unit in the locations where:**
 - There are heat sources nearby.
 - Unit is directly exposed to rain or sunlight.
 - There is any obstacle which can prevent smooth air circulation from inlet and outlet side of the unit.
 - Unit is directly exposed to oil mist and steam such as kitchen.
 - Chemical substances like ammonia (organic fertilizer), calcium chloride (snow melting agent) and acid (sulfurous acid etc.), which can harm the unit, will generate or accumulate.
 - Drain water can not be discharged properly.
 - TV set or radio receiver is placed within 1 m.
 - Height above sea level is more than 1000 m.
 It can cause performance degradation, corrosion and damage of components, unit malfunction and fire.
- **Dispose of all packing materials properly.**
Packing materials contain nails and wood which can cause personal injury.
Keep the polybag away from children to avoid the risk of suffocation.
- **Do not put anything on the outdoor unit.**
Object may fall causing property damage or personal injury.
- **Do not touch the aluminum fin of the outdoor unit.**
Aluminium fin temperature is high during heating operation. Touching fin can cause burn.
- **Do not touch any refrigerant pipe with your hands when the system is in operation.**
During operation the refrigerant pipes become extremely hot or extremely cold depending on the operating condition. Touching pipes can cause personal injury like burn (hot/cold).
- **Install isolator or disconnect switch on the power source wiring in accordance with the local codes and regulations.**
The isolator should be locked in OFF state in accordance with EN60204-1.

1. ACCESSORIES AND TOOLS

Standard accessories (supplied with indoor unit)				Locally procured parts		Tools for installation work	
(1) Installation board		1pc.	(5) Wood screws (for remote control holder φ3.5 X 16 mm)		2pcs.	Plus headed driver	Hole core drill (65 mm in diameter)
(2) Wireless remote control		1pc.	(6) Batteries [R03 (AAA, Micro) 1.5 V]		2pcs.	Knife	Wrench key (Hexagon) [4 mm]
(3) Remote control holder		1pc.	(7) Insulation (#486 50 X 100 t3)		1pc.	Saw	Flaring tool set*
(4) Tapping screws (for installation board φ4 X 25 mm)		10pcs.				Tape measure	Gas leak detector*
						Torque wrench (14.0-62.0 N·m (1.4-6.2 kgf·m))	Pipe bender
						Plier	Gauge for projection adjustment (Used when flare is made by using conventional flare tool)
						Pipe cutter	

* Designed specifically for R32 or R410A

2. SELECTING INSTALLATION LOCATION

After getting customer's approval, select installation location according to following guidelines.

1. Indoor unit

- Where there is no obstruction to the airflow and where the cooled and heated air can be evenly distributed.
- A solid place where the unit or the wall will not vibrate.
- A place where there will be enough space for servicing. (Where space mentioned on the right side can be secured.)
- Where it is easy to conduct wiring and piping work.
- A place where unit is not directly exposed to sunlight or street light.
- A place where it can be easily drained.
- A place separated at least 1 m away from the television or the radio. (To prevent interference to images and sounds.)
- A place where this unit is not affected by the high frequency equipment or electric equipment.
- Avoid installing this unit in place where there is much oil mist.
- A place where there is no electric equipment or household.
- Install the indoor unit on the wall where the height from the floor to the bottom of the unit is more than 180 cm.

2. Remote control

- A place where the air-conditioner can receive the signal surely during operating the remote control.
- A place where it is not affected by the TV, radio etc.
- Do not place where it is exposed to direct sunlight or near heat devices such as a stove.

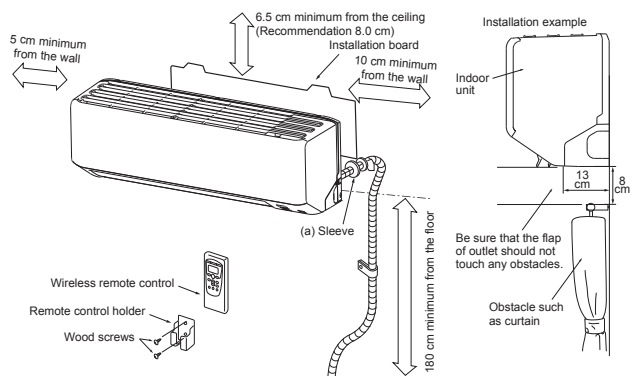

3. INSTALLING INSTALLATION BOARD

- Installation board should be installed on the wall which can support the weight of the indoor unit.
- Adjustment of the installation board in the horizontal direction is to be conducted with 5 screws in a temporary tightened state.
- With the standard hole as a center, adjust the board and level it.

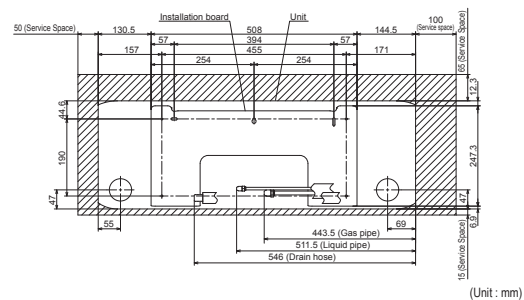
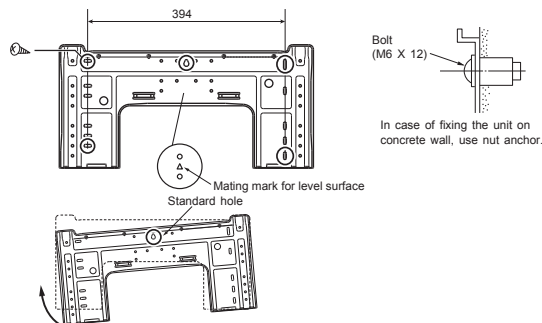

CAUTION
Improper adjustment of the installation board can cause water leakage.

4. DRILLING HOLE AND FIXTURE OF SLEEVE

When drilling the wall that contains a metal lath, wire lath or metal plate, be sure to use sealing plate, sleeve and inclination plate (Locally procured parts).

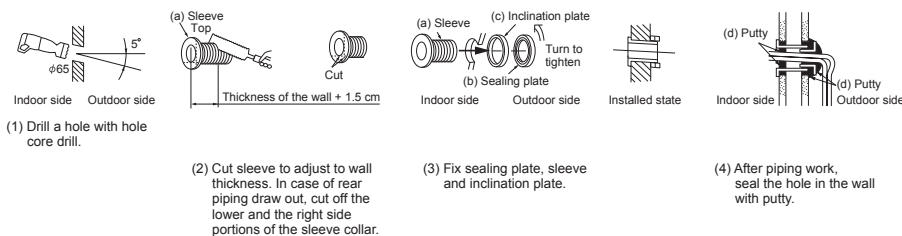

5. ELECTRICAL WIRING WORK

- Before installation, make sure that the power source complies with the air-conditioner's power specification.
- Carry out electrical wiring work according to following guidelines.

1. Preparing cable

- Selecting cable
Select the connecting cable in accordance with the specifications mentioned below.
4-core* 1.5 mm² conformed with 60245 IEC57
* 1 Earth wire is included (Yellow/Green).
- Arrange each wire length as shown below.
Make sure that each wire is stripped 10 mm from the end.

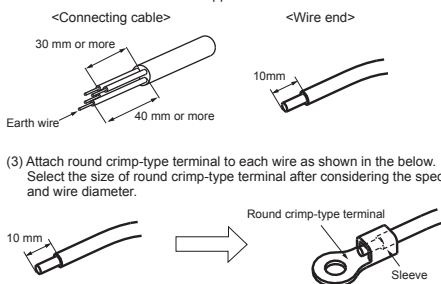

2. Connecting cable

- Remove the lid.
- Remove the terminal cover.
- Remove the cable clamp.
- Connect the connecting wire to the terminal block.
- Fix the connecting cable by cable clamp.
- Fix the terminal cover.
- Fix the lid.

NOTE

Take care not to confuse the terminal numbers for indoor and outdoor connections.

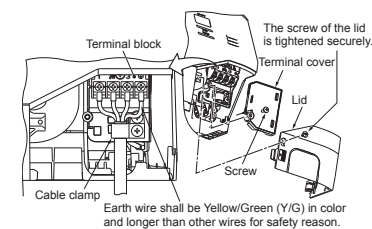

WARNING
Incorrect wiring connection can cause malfunction or fire.

6. FORMING PIPING AND DRAIN HOSE

1. Forming piping

Piping is possible in the right, rear, downward, left, left rear or left downward direction.

NOTE

Sufficient care must be taken not to damage the panels when connecting pipes.

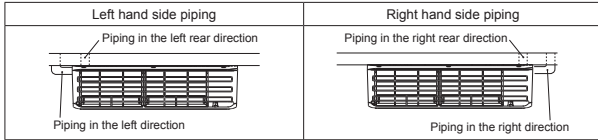
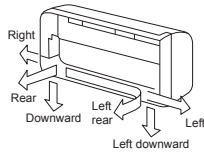

Forming of pipings.

- Hold the bottom of the piping and fix direction before stretching it and shaping it.

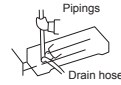

Taping of the exterior

- Tape only the portion that goes through the wall.
- Always tape the wiring with the piping.



2. Drain change procedures

- Remove the screw and drain hose.
- Remove the drain cap by hand or pliers.
- Insert the drain cap which was removed at procedure (2) securely using a hexagonal wrench etc.
- Install the drain hose and screw securely.

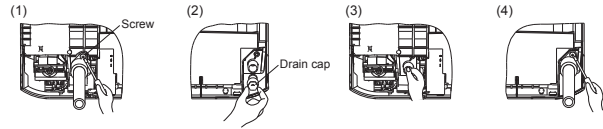

CAUTION

Incorrect installation of drain hose and cap can cause water leakage.

7. DRAINAGE WORK

- Arrange the drain hose in a downward angle.
- Avoid the following drain piping.

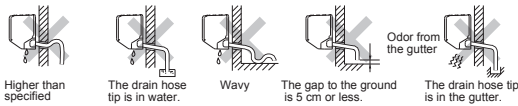

- Pour water to the drain pan located under the heat exchanger, and ensure that the water is discharged outdoor.
- When extended drain hose is present inside the room, insulate it securely with heat insulator available in the market.

Since this air-conditioner is designed to collect dew drops on the rear surface to the drain pan, do not install the connecting wire above the gutter.

CAUTION

Incorrect drainage work can cause water leakage.

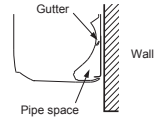

8. INSTALLING INDOOR UNIT

Installing the indoor unit to installation board

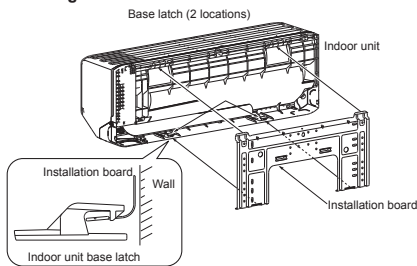

- Pass the pipe through the hole in the wall, and hook the upper part of the indoor unit to the installation board.



- Gently push the lower part to fix the indoor unit base lower latch to installation board.



Removing the indoor unit from installation board

- Push up at the marked portion of the indoor unit base latch, and slightly pull it toward you (both right and left hand sides). (The indoor unit base latch can be removed from the installation board.)
- Push up the indoor unit upward so that it can be removed from installation board.

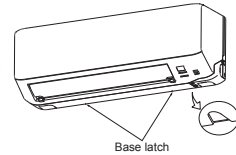

9. CONNECTING PIPING WORK

1. Preparation of connecting pipe

1.1. Selecting connecting pipe

Select connecting pipe according to the following table.

Gas pipe	Φ9.52
Liquid pipe	Φ6.35

- Pipe wall thickness must be greater than or equal to 0.8 mm.
- Pipe material must be O-type (Phosphorus deoxidized seamless copper pipe ICS 23.040.15, ICS 77.150.30).

1.2. Cutting connecting pipe

- Cut the connecting pipe to the required length with pipe cutter.
- Hold the pipe downward and remove the burrs. Make sure that no foreign material enters the pipe.
- Cover the connecting pipe ends with the tape.

2. Piping work

2.1. Flaring pipe

- Take out flare nuts from the operation valves of indoor unit and engage them onto connecting pipes.
- Flare the pipes according to table and figure shown below.

Flare dimensions for R32 are different from those for conventional refrigerant. Although it is recommended to use the flaring tools designed specifically for R32 or R410A, conventional flaring tools can also be used by adjusting the dimension B with a flare adjustment gauge.

Copper pipe outer diameter	A	B [Rigid (clutch) type]	
		R32 or R410A	Conventional
Φ6.35	9.1	0-0.5	1.0-1.5
Φ9.52	13.2		

2.2 Connecting pipes

- Connect pipes on both liquid and gas sides.
- Tighten nuts to specified torque shown in the table below.

Operation valve size (mm)	Tightening torque (N·m)
Φ6.35 (1/4")	14-18
Φ9.52 (3/8")	34-42

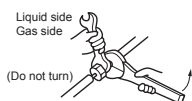

CAUTION

- Do not apply refrigerating machine oil to the flared surface. It can cause refrigerant leakage.
- Do not apply excess torque to the flared nuts. The flared nuts may crack resulting in refrigerant leakage.

3. Heating and condensation prevention

- Dress the connecting pipes (both liquid and gas pipes) with insulation to prevent it from heating and dew condensation. Use the heat insulating material which can withstand 120 °C or higher temperature. Make sure that insulation is wrapped tightly around the pipes and no gap is left between them.
- Wrap the refrigerant pipings of indoor unit with indoor unit heat insulation using tape.
- Cover the flare-connected joints (indoor side) with the indoor unit heat insulation and wrap it with an insulation pad (standard accessory provided with indoor unit).
- Wrap the connecting pipes, connecting cable and drain hose with the tape.

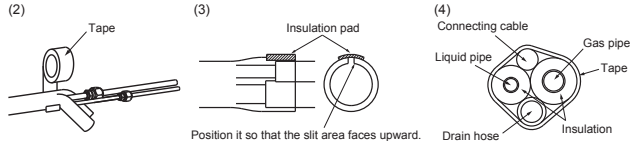

NOTE

Locations where relative humidity exceeds 70 %, both liquid and gas pipes need to be dressed with 20 mm or thicker heat insulation materials.

CAUTION

- Improper insulation can cause condensate(water) formation during cooling operation. Condensate can leak or drip causing damage to household property.
- Poor heat insulating capacity can cause pipe outer surface to reach high temperature during heating operation. It can cause cable deterioration and personal injury.

4. Finishing work

- Make sure that the exterior portion of connecting pipes, connecting cable and drain hose is wrapped properly with tape. Shape the connecting pipes to match with the contours of the pipe assembly route.
- Fix the pipe assembly with the wall using clamps and screws. Pipe assembly should be anchored every 1.5 m or less to isolate the vibration.
- Install the service cover securely. Water may enter the unit if service cover is not installed properly, resulting in unit malfunction and failure.

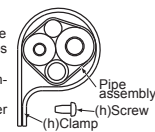

CAUTION

Make sure that the connecting pipes do not touch the components within the unit. If pipes touch the internal components, it may generate abnormal sounds and/or vibrations.

10. HOW TO OPEN, CLOSE, REMOVE AND INSTALL THE AIR INLET PANEL

1. Open
Pull the air inlet panel at both ends of lower part and release latches, then pull up the panel until you feel resistance.
(The panel stops at approx. 70° open position)

2. Close
Hold the panel at both ends of lower part, lower it downward slowly, then push it slightly until the latch works.

3. Removing
Open the panel by 90° (as shown in the right illustration) and then pull it forward.

4. Installing
Insert the panel arm into the slot on the front panel from the position shown in right illustration, hold the panel at both ends of lower part, lower it downward slowly, then push it slightly until the latch works.

11. HOW TO REMOVE AND INSTALL FRONT PANEL

1. Removing
(1) Remove the air inlet panel and the air filters.
(2) Remove the 2 screws.
(3) Remove the 3 upper latches and then front panel can be removed.

2. Installing
(1) Cover the unit with the front panel and fix 3 upper latches.
(2) Secure the front panel with the 2 screws.
(3) Install the air inlet panel and the air filters.

12. INSTALLING WIRELESS REMOTE CONTROL

Mount the batteries
(1) Slide and take out the cover of backside.
(2) Mount the batteries [R03 (AAA, Micro), × 2 pieces] in the body properly.
(Fit the poles with the indication marks + & -)
(3) Set the cover again.

Installing remote control holder
(1) Select the place where the unit can receive signals.
(2) Fix the holder to pillar or wall with wood screws.

NOTE
• Do not use new and old batteries together.
• In case the unit is not operated for a long time, take out the batteries

13. INSTALLING TWO AIR-CONDITIONERS IN THE SAME ROOM

In case two air-conditioners are installed in the same room, apply this setting so that one unit can be operated with only one wireless remote control.

Setting one wireless remote control
(1) Slide and take out the cover and batteries.
(2) Cut the switching line next to the battery with wire cutters.
(3) Set the batteries and cover again.

Setting one indoor unit
(1) Remove the front panel.
(2) Remove the control cover. (Remove the screw.)
(3) Cut jumper wire J2 (marked CUSTOM on the PCB) on the indoor control board. Do not allow the cut wires to contact any other wiring.
(4) Install the control box and front panel.

14. PUMP DOWN WORK

For the environmental protection, be sure to pump down when relocating or disposing of the unit. Pump down is the method of recovering refrigerant from the indoor unit to the outdoor unit before the connecting pipes are removed from the unit. When pump down is carried out, forced cooling operation is needed.

Forced cooling operation
(1) Turn off the power source and turn it on again after 1 minute.
(2) Press the ON/OFF button continuously for at least 5 seconds. Then operation will start.

For the detail of pump down, refer to the installation manual of outdoor unit.

15. INSTALLATION CHECK AND TEST RUN

After finishing the installation work, check the following points again before turning on the power. Conduct a test run and ensure that the unit operates properly. At the same time, explain to the customer how to use the unit and how to take care of the unit following the user's manual.

Before test run
Before test run, check following points.

Power source voltage complies with the rated voltage of air-conditioner.	
Earth leakage breaker and circuit breaker are installed.	
Power cable and connecting cable are securely fixed to the terminal block.	
Both liquid and gas operation valves are fully open.	
No gas leaks from the joints of the operation valves.	
Indoor and outdoor side pipe joints have been insulated.	
Hole on the wall is completely sealed with putty.	
Drain hose and cap are installed properly.	
Screw of the lid is tightened securely.	

Test run
Check following points during test run.

Indoor unit receives signal of remote control.	
Air-conditioning operation is normal.	
There is no abnormal noise.	
Water drains out smoothly.	
Display of remote control is normal.	

After test run

Explain the operating and maintenance methods to the user according to the user's manual.	
Keep this installation manual together with user's manual.	



NOTE
During restart or change in operation mode, the unit will not start operating for approximately 3 minutes. This is to protect the unit and it is not malfunction.

(2) Floor standing type (SRF)

Models SRF25ZS-W, 35ZS-W, 50ZSX-W

 <p>CAUTION</p>	<p>• Carry out the electrical work for ground lead with care. Do not connect the ground lead to the gas line, water line, lightning conductor or telephone line's ground lead. Incorrect grounding can cause unit faults such as electric shocks due to short-circuiting.</p> <p>• Use the circuit breaker of correct capacity. Circuit breaker should be able to disconnect all poles under over current. Using the incorrect one could cause the system failure and fire.</p> <p>• Install isolator or disconnect switch on the power source wiring in accordance with the local codes and regulations.</p> <p>• Be sure to install indoor unit property according to instruction (E06Z24-1). Improper installation of indoor unit can cause dripping water into the room and damaging personal property.</p> <p>• Install the drainage pipe to run off drainage securely according to the installation manual. Incorrect installation of the drainage pipe can cause dripping water into the room and damaging personal property.</p> <p>• Be sure to install the drainage pipe with descending slope of 1/100 or more, and not to make traps and air-bleedings. Check if the drainage runs off securely during commissioning and ensure the space for inspection and maintenance.</p> <p>• After maintenance, all wiring, wiring ties and the like, should be returned to their original state and wiring route, and the necessary clearance from all metal parts should be secured.</p> <p>• Secure a space for installation, inspection and maintenance specified in the manual. Insufficient space can result in accident such as personal injury due to falling from the installation place.</p> <p>• Take care when carrying the unit by hand. If the unit weighs more than 20 kg, it must be carried by two or more persons. Do not carry by the plastic straps, always use the carry handle</p>
 <p>WARNING</p>	<p>• Do not install the unit where corrosive gas (such as sulfuric acid gas etc.) or combustible gas (such as propane and petroleum substances) are accumulated or collect, or where volatile combustible substances are handled. Corrosive gas can cause corrosion of heat exchanger, breakage of plastic parts and etc. And combustible gas can cause fire.</p> <p>• Do not use the indoor unit at the place where water splashes may occur such as in laundries. Since the indoor unit is not waterproof, it can cause electric shocks and fire.</p> <p>• Do not install nor use the system close to the equipment that generates electromagnetic fields or high frequency harmonics. Equipment such as inverters, standby generators, medical high frequency equipment and telecommunication equipments can affect the system, and cause malfunctions and breakdowns. The system can also affect medical equipment and telecommunication equipment, and obstruct its function or cause jamming.</p> <p>• Do not place any variables which will be damaged by getting wet under the indoor unit. When the relative humidity is higher than 80 % or drainage pipe is clogged, condensation or drainage water can drop and it can cause the damage of variables.</p> <p>• Do not install the remote control at the direct sunlight. It can cause malfunction or deformation of the remote control.</p> <p>• Do not use the unit for special purposes such as storing foods, cooling precision instruments and preservation of animals, plants or art. It can cause the damage of the items.</p> <p>• Do not use any materials other than a fuse with the correct rating in the location where fuses are to be used. Connecting the circuit with copper wire or other metal thread can cause unit failure and fire.</p> <p>• Do not touch any buttons with wet hands. It can cause electric shocks.</p> <p>• Do not touch any refrigerant pipes with your hands when the system is in operation. During operation the refrigerant pipes become extremely hot or extremely cold depending on the operating condition, and it can cause burn injury or frost injury.</p> <p>• Do not wash the inside of the air-conditioner. Water leakage and permanent damage may result. Electrical hazard exists.</p>
 <p>WARNING</p>	<p>• Do not install the unit in the locations listed below.</p> <ul style="list-style-type: none"> • Locations where carbon fiber, metal powder, or any powder is floating • Locations where any substances that can affect the unit such as sulphide gas, chloride gas, acid and alkaline can occur. • Vehicles and ships • Locations where cosmetic or special sprays are often used. • Locations with direct exposure of oil mist and steam such as kitchen and machine plant. • Locations where any machines which generate high frequency harmonics are used. • Locations with salty atmospheres such as coastlines. • Locations with heavy snow (if installed, be sure to provide base frame and snow hood mentioned in the manual). • Locations where the unit is exposed to chimney smoke. • Locations at high altitude (more than 1000 m high). • Locations with ammoniac atmospheres (e.g. organic fertilizer). • Locations with calcium chloride (e.g. snow melting agent). • Locations where heat radiation from other heat source can affect the unit. • Locations with any obstacles which can prevent inlet and outlet air of the unit. • Locations where short-circuit of air can occur (in case of multiple units installation). • Locations where strong air blows against the air outlet of outdoor unit. • Locations where something located above the unit could fall. <p>It can cause remarkable decrease in performance, corrosion and damage of components, malfunction and fire.</p> <p>• Do not install the indoor unit in the locations listed below (Be sure to install the indoor unit according to the installation manual for each model) because each indoor unit has each limitation).</p> <ul style="list-style-type: none"> • Locations with any obstacles which can prevent inlet and outlet air of the unit. • Locations where vibration can be amplified due to insufficient strength of structure. • Locations where the infrared receiver is exposed to the direct sunlight or the strong light beam (in case of the infrared specification unit). • Locations where an equipment affected by high harmonics is placed (TV set or radio receiver is placed within 1 m). • Locations where drainage cannot run off safely. • Locations where performance or function and etc. <p>• Do not install the unit near the location where leakage of combustible gases can occur. If leaked gases accumulate around the unit, it can cause fire.</p>

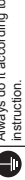
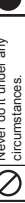
 <p>WARNING</p>	<p>• Always do it according to the instruction.</p> <p>• Never do it under any circumstances.</p>
 <p>WARNING</p>	<p>• Tighten the flare nut by torque wrench with specified method. If the flare nuts were tightened with excess torque, this may cause burst and refrigerant leakage after a long period.</p> <p>• The electrical installation must be carried out by the qualified electrician in accordance with "The norm for electrical work" and "national wiring regulation", and the system must be connected to the dedicated circuit. Power source with insufficient capacity and incorrect function done by improper work can cause electric shocks and fire.</p> <p>• Be sure to shut off the power before starting electrical work. Failure to shut off the power can cause electric shocks, unit failure or incorrect function of the product.</p> <p>• Be sure to use the cables conformed to safety standard and cable ampacity for power distribution work. Unconformable cables can cause electric leak, anomalous heat production or fire.</p> <p>• This appliance must be connected to main power source by means of a circuit breaker or switch (fuse:16 A) with a contact separation of at least 3 mm.</p> <p>• Use the prescribed cables for electrical connection, tighten the cables securely in terminal block and relieve the cables correctly to prevent overloading the terminal blocks. Loose connections or cable mountings can cause anomalous heat production or fire.</p> <p>• Arrange the wiring in the control box so that it cannot be pushed up further into the box. Install the service panel correctly. Incorrect installation may result in overheating and fire.</p> <p>• Be sure to switch off the power source in the event of installation, inspection or servicing. If the power source is not shut off, there is a risk of electric shocks, unit failure or personal injury due to the unexpected start of fan.</p> <p>• Earth leakage breaker must be installed. If the earth leakage breaker is not installed, it can cause electric shocks.</p>
 <p>WARNING</p>	<p>• Do not bundle or wind or process the power cable. Do not deform the power cable by treading it. This may cause fire or heating.</p> <p>• Do not vent R32 or R410A into atmosphere. R32 is a fluorinated greenhouse gas with a Global Warming Potential (GWP) = 675. R410A is a fluorinated greenhouse gas with a Global Warming Potential (GWP) = 2088.</p> <p>• Do not run the unit with removed panels or protections. Touching rotating equipments, hot surfaces or high voltage parts can cause personal injury due to entrapment, burn or electric shocks.</p> <p>• Do not perform any change of protective device itself or its setup condition. The forced operation by short-circuiting protective device of pressure switch and temperature control or the use of non specified component can cause fire or burst.</p>

 <p>WARNING</p>	<p>• Always do it according to the instruction.</p> <p>• Never do it under any circumstances.</p>
 <p>WARNING</p>	<p>• Installation must be carried out by the qualified installer. If you install the system by yourself, it may cause serious trouble such as water leaks, electric shocks, fire and personal injury, as a result of a system malfunction. Do not carry out the installation and maintenance work except the by qualified installer.</p> <p>• Install the system in full accordance with the installation manual. Incorrect installation may cause bursts, personal injury, water leaks, electric shocks and fire.</p> <p>• Be sure to use only for household and residence. This appliance is installed in interior environment such as machine shop etc. and it can cause malfunctioning.</p> <p>• Use the original accessories and the specified components for installation. Use of parts other than those prescribed by us are used, it may cause water leaks, electric shocks, fire and personal injury.</p> <p>• Install the unit in a location with good support. Unsuitable installation locations can cause the unit to fall resulting in material damage and personal injury.</p> <p>• Ventilate the working area well in the event of refrigerant leakage during installation. If the refrigerant comes into contact with naked flames, poisonous gas is produced.</p> <p>• When installing in small rooms, take prevention measures not to exceed the density limit of refrigerant in the event of leakage. If the density of refrigerant exceeds the limit, consult the dealer and install the ventilation system, otherwise lack of oxygen can occur, which can cause serious accident.</p> <p>• After completing installation, check that no refrigerant leaks from the system. If refrigerant leaks into the room and comes into contact with an oven or other hot surface, poisonous gas is produced.</p> <p>• Use the prescribed pipes, flare nuts and tools for R32 or R410A. Using existing parts (for R22 or R407C) can cause the unit failure and serious accidents due to burst of the refrigerant circuit.</p>
 <p>WARNING</p>	<p>• Do not put the drainage pipe directly into drainage channels where poisonous gases such as sulphide gas can occur. Poisonous gases will flow into the room through drainage pipe and seriously affect the user's health and safety. This can also cause the corrosion of the indoor unit and a resultant unit failure or refrigerant leak.</p> <p>• Ensure that no air enters in the refrigerant circuit when the unit is installed and removed. If air enters in the refrigerant circuit, the pressure in the refrigerant circuit becomes too high, which can cause burst and personal injury.</p> <p>• Do not process or splice the power cable, or share the socket with other power plugs. This may cause fire or electric shock due to detecting contact, detecting insulation and over-current etc.</p>

RFB012A008B

• This installation manual illustrates the method of installing an indoor unit.

• For electrical wiring work, please see instructions set out on the backside.

• For outdoor unit installation and refrigerant piping, please refer to page 9.

SAFETY PRECAUTIONS

• Before installation, read the "SAFETY PRECAUTIONS" carefully and strictly follow it during the installation work in order to protect yourself.

• The precautionary items mentioned below are distinguished into two levels.

• **WARNING** and **CAUTION**

• **WARNING**: Wrong installation would cause serious consequences such as injuries or death.

• **CAUTION**: Wrong installation might cause serious consequences depending on circumstances.

Both mention the important items to protect your health and safety so strictly follow them by any means.

• Be sure to confirm no anomaly on the equipment by commissioning after completed installation and explain the operating methods as well as the maintenance methods of this equipment to the user according to the user's manual.

BEFORE INSTALLATION

○ Before installation check that the power source matches the air-conditioner.

Standard accessories (Installation kit)		Qty
Accessories for indoor unit		
①	Installation board (Attached to the rear of the indoor unit)	1
②	Wireless remote control	1
③	Remote control holder	1
④	Tapping screws (for installation board $\phi 4 \times 25$ mm)	9
⑤	Wood screws (for remote control switch holder $\phi 3.5 \times 16$ mm)	2
⑥	Battery (R03 (AAA, Micro) 1.5 V)	2
⑦	Air-cleaning filters	2
⑧	Filter holders (Attached to the front panel of indoor unit)	2
⑨	Pipe cover (200 mm)	1
⑩	Band	2

Locally procured parts		Qty
③	Sealing plate	1
④	Sleeve	1
⑤	Inclination plate	1
⑥	Putty	1
⑦	Drain hose (extension hose)	1
⑧	Piping cover (for insulation of connection piping)	1

Necessary tools for the installation work	
1	Plus headed driver
2	Knife
3	Saw
4	Tape measure
5	Hammer
6	Spanner wrench
7	Torque wrench (14.0 – 61.0 N·m (1.4 – 6.1 kgf·m))
8	Hole core drill (65 mm in diameter)
9	Wrench key (Hexagon) [4 mm]
10	Flaring tool set (Designed specifically for R32 or R410A)
11	Gas leak detector (Designed specifically for R32 or R410A)
12	Gauge for projection adjustment (Used when flare is made by using conventional flare tool)
13	Pipe bender

SELECTION OF INSTALLATION LOCATION
(Install at location that meets the following conditions, after getting approval from the customer)

- Indoor unit**
- Where there is no obstructions to the air flow and where the cooled and heated air can be evenly distributed.
 - A solid place where the unit or the wall will not vibrate.
 - A place where there will be enough space for servicing. (Where space mentioned right can be secured)
 - Where wiring and the piping work will be easy to conduct.
 - The place where receiving part is not exposed to the direct rays of the sun or the strong rays of the street lighting.
 - A place where it can be easily drained.
 - A place where there is no interference from the television or the radio. (To prevent interference to images and sounds.)
 - Avoid installing this unit in place where there is much oil mist.
 - Places where there is no electric equipment or household under the installing unit.
 - Install the indoor unit on flat wall.

Wireless remote control

- A place where the air-conditioner can be received the signal surely during operating the wireless remote control.
- Places where there is no affected by the TV and radio etc.
- Do not place where exposed to direct sunlight or near heat devices such as a stove.

INSTALLATION OF INDOOR UNIT

Open and detachment of the air inlet panel

- To open, pull the panel at both ends of upper part and release latches, and undo the strings. Then remove the panel.

△ CAUTION
When removing the air inlet panel, be careful not to drop it on your feet.

How to remove the front panel

- 1 Remove the air inlet panel.
- 2 Remove the 5 set screws.
- 3 Remove the 3 latches in the upper section. If the latches are difficult to remove, push the latch portion out using a screw driver, for example.
- 4 Move the lower part of the panel forward and remove the 6 latches in the under section.

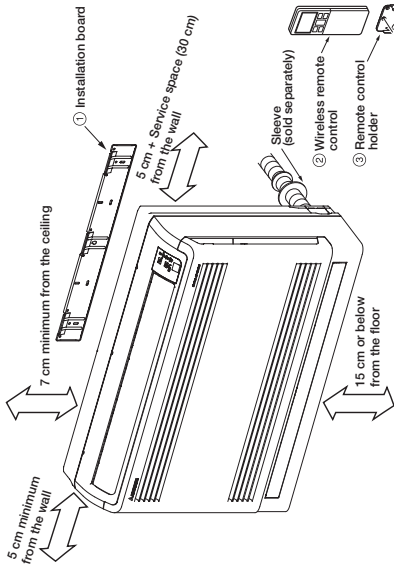
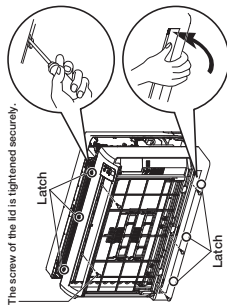
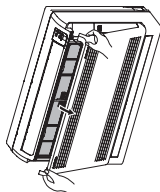

△ WARNING
Completely seal the hole in the wall with putty. If not sealed properly, moisture may enter the room from outside, which could result in fire or other hazards.

△ CAUTION
Completely seal the hole in the wall with putty. If not sealed properly, furniture and other fixtures may be damaged by water leakage or condensation.

Installing the support of piping

In case of piping in the right-rear direction

- Tape only the portion that goes through the wall.
- Always tape the wiring with the piping.



Sufficient care must be taken not to damage the panel when connecting pipes.

△ CAUTION

Be careful not to stress the connecting refrigerant pipes. (Do not pull with a force of larger than 5 kgf.) If improperly installed, it may cause abnormal noise and vibration.

Drilling of holes and fixture of sleeve (Locally procured parts)

When drilling the wall that contains a metal lath, wire lath or metal plate, be sure to use pipe hole sleeve sold separately.

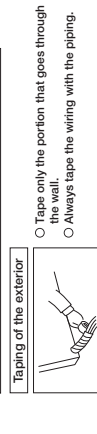
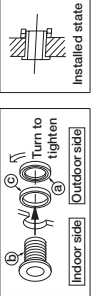
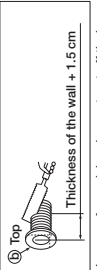
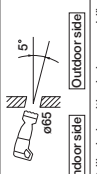

Indoor unit piping direction

Piping is possible in the rear, left, right rear, left downward, right or downward direction.

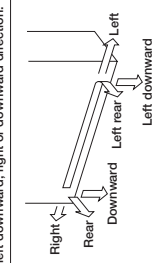

For Right or Left rear piping

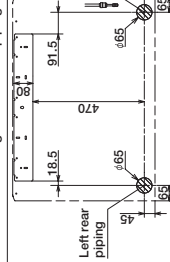

For Right or Left piping

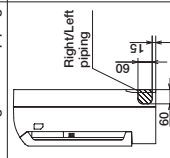

For Right or Left bottom piping

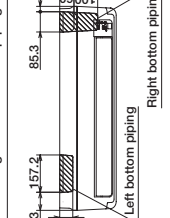

Drainage

- Arrange the drain hose in a downward angle.
- Avoid the following drain piping.

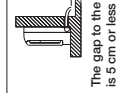

△ CAUTION Go through all installation steps and check if the drainage is all right. Otherwise water leak may occur.

- Pour water to the drain pan located under the heat exchanger, and ensure that the water is discharged outdoor.
- The drain hose is indoor, securely insulate it with a heat insulator available in the market.

Fixing of indoor unit

⚠ **CAUTION** • During the installation, do not lean on the control box or the display, as they may be damaged.
• Install the indoor unit on flat wall. If improperly installed, it may cause abnormal noise and vibration. (Distortion on the wall shall be no larger than 3 mm.)

Floor installation

Secure using upper 2 screws for floor installations. If possible, also attach two lower screws.

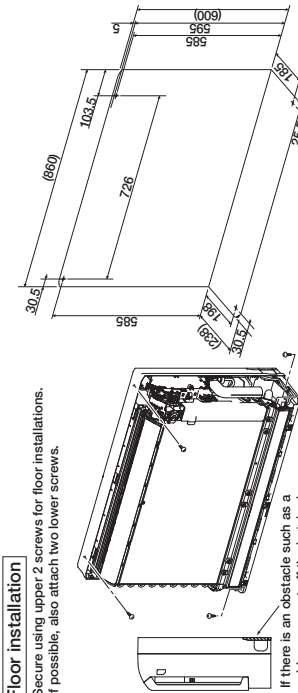

Wall installation

At first secure the installation board using 5 screws and the indoor unit using 2 screws.

Installation of Installation board

Look for the inside wall structures (intermediate support or pillar) and finally install the unit after level surface has been checked.

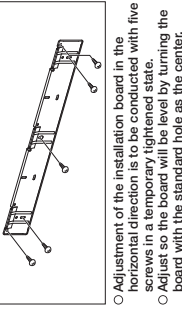

④ Tapping screw

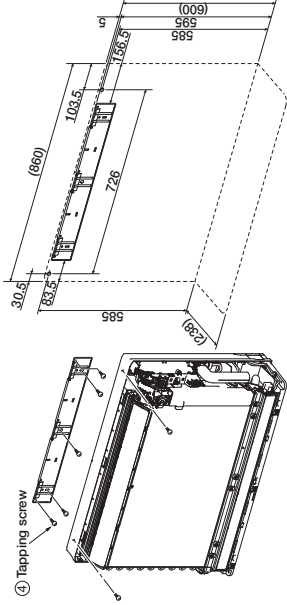

○ When practicing the half-console, make sure to fix the unit securely. Otherwise, it could fall.

CONNECTION OF REFRIGERANT PIPINGS

Preparation Keep the openings of the pipes covered with tapes etc. to prevent dust, sand, etc. from entering them.



(Do not turn) Remove Press



○ Remove the flared nuts. (on both liquid and gas sides)

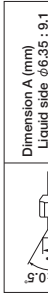

○ Install the removed flared nuts to the pipes to be connected, then flared the pipes.

Indoor

Do not turn
Liquid side
Gas side

○ Connect the pipes on both liquid and gas sides.

○ Tighten the nuts to the following torque.
Liquid side (φ6.35) : 14.0 - 18.0 N·m (1.4 - 1.8 kgf·m)
Gas side (φ9.52) : 34.0 - 42.0 N·m (3.4 - 4.2 kgf·m)
(φ12.7) : 49.0 - 61.0 N·m (4.9 - 6.1 kgf·m)

⚠ **CAUTION** Be careful not to stress the connecting refrigerant pipes. (Do not pull with a force of larger than 5 kgf.)

Finishing work and fixing

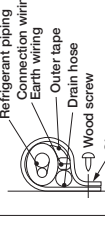

Cover the exterior portion with outer tape and shape the piping so it will match the contours of the route that the piping take. Also fix the wiring and pipings to the wall with clamps.

○ Do not apply excess torque to the flared nuts. Otherwise, the flared nuts may check depending.

⚠ **CAUTION** Do not apply excess torque to the flared nuts. Otherwise, the flared nuts may check depending.

Flaring work

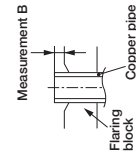

Copper pipe diameter	Measurement B (mm)	
	Clutch type flare tool for R32 or R410A	Conventional (R22) flare tool
φ6.35	0.0 - 0.5	Clutch type : 1.0 - 1.5 Wiring nut type : 1.5 - 2.0
φ9.52	0.0 - 0.5	1.0 - 1.5
φ12.7	0.0 - 0.5	1.0 - 1.5
		2.0 - 2.5

Use a flare tool designed for R32, R410A or a conventional flare tool. Note that measurement B (protrusion from the flaring block) will vary depending on the type of a flare tool in use. If a conventional flare tool is used, use a copper pipe gauge or a similar instrument to check protrusion so that you can keep measurement B to a correct value.

Insulation of the connection portion

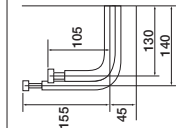

Pass the refrigerant pipe through the piping hole to indoor side. Arrange the pipes according to the direction of piping.

Cover the coupling with insulator and then cover it with tapes. Use an attached ③ pipe cover for heat insulation.

⚠ **CAUTION** If heat insulation is insufficient, water leakage may occur. In addition, the room temperature sensor may give a false alert due to heat radiation from the pipes.
• Cover the indoor unit's flare-connected joints, after they are checked for a gas leak, with an indoor unit heat insulating material and then wrap them with a tape with an attached ③ pipe cover placed over the heat insulating material's slit area.

Position it so that the slit area faces upward.

ELECTRICAL WIRING WORK

Preparation of indoor unit

Mounting of connecting wires

- Remove the fixing screw of clamp.
- Connect the connecting wire securely to the terminal block. If the wire is not affixed completely, contact will be poor, and it is dangerous as the terminal block may heat up and catch fire.
- Take care not to confuse the terminal numbers for indoor and outdoor connections.
- Fix the connecting wire by wiring clamp.
- Pass the connecting wire through the wiring holder.

○ In case of faulty wiring connection, the indoor unit stops, and then the run lamp turns on and the timer lamp blinks.

Use cables for interconnection wiring to avoid loosening of the wires. CENELEC code for cables Required field cables.
H05RN-RAG1.5 (example) or 2451EC57
H Harmonized cable type
300/500 volts
R Natural-and/or synth, rubber wire insulation
N Polychloroprene rubber conductors insulation
R Stranded core
4 or 5 Number of conductors
G One conductor of the cable is the earth conductor (yellow/green)
1.5 Section of copper wire (mm²)

⚠ **CAUTION**
• During installation, do not lean on the control box or the display, as they may be damaged.
• Press the connecting wire securely through the wiring holder. If it passes the sensor, it may not detect suction temperature and/or humidity.

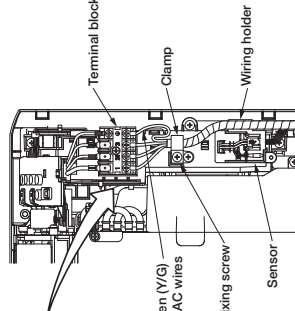
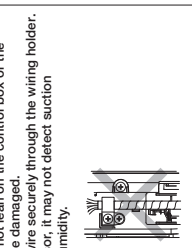

• Earth wire shall be Yellow/Green (Y/G) in color and longer than other AC wires for safety reason.

How to fit the front panel

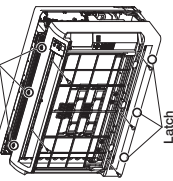

- Offitting**
1. Do remove the air filter.
 2. Cover the body with the front panel.
 3. Fit the 6 latches in the lower section, then 3 latches in the upper section.
 4. Tighten the 5 set screws.
 5. Fit the air filter.
 6. Fit the air inlet panel.

Close and attachment of the air inlet panel

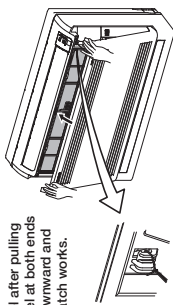

- To close, attach the panel after pulling the strings, hold the panel at both ends or upper part to lower downward and push it slightly until the latch works.

Installing the air-cleaning filters

1. Open the air inlet panel and remove the air filters.
2. Install the air-cleaning filter in the filter holders, and then install the filter holders in the air-conditioner.
 - Each air-cleaning filter can be installed in the upper or lower filter holder.
3. Install the air filters and close the inlet panel.

CAUTION
When installing an air-cleaning filter in the indoor unit, be careful not to injure your hand with the heat exchanger.

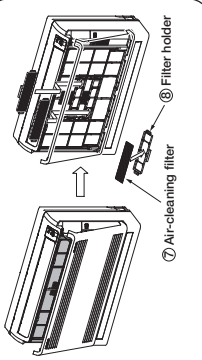

INSTALLING TWO AIR-CONDITIONERS IN THE SAME ROOM

When two air-conditioners are installed in the same room, use this setting when the two air-conditioners are not operated with one remote control. Set the remote control and indoor unit.

Setting the remote control

1. Pull out the cover and take out batteries.
2. Disconnect the switching line next to the battery with wire cutters.
3. Insert batteries. Close the cover.

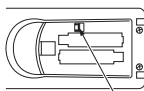

Setting an indoor unit

1. Turn off the power source, and turn it on after 1 minute.
2. Point the remote control that was set according to the procedure described on the left side at the indoor unit and send a signal by pressing the ACL switch on the remote control. Since the signal is sent in about 6 seconds after the ACL switch is pressed, point the remote control at the indoor unit for some time.

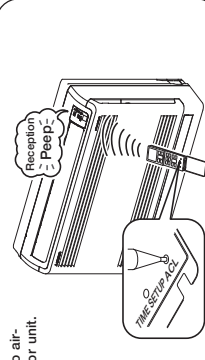

3. Check that the reception buzzer sound "Peep" is emitted from the indoor unit. At completion of the setting, the indoor unit emits a buzzer sound "Peep". (If no reception tone is emitted, start the setting from the beginning again.)

Concealed installation

- Install the indoor unit according to the following instructions.
1. Secure the upper, right, and left spaces according to the right figure.
 2. Do not let the horizontal bar obstruct wind from blowing out upward/downward or reception from the remote control.
 3. The lattice size should be 70% or greater of the open rate.
 4. Cut the jumper cable (JP173) on the indoor circuit board to control the blow-out angle.

CAUTION
Incorrect installation may cause problems such as non-cooling, non-warming, and condensation water leaking into the room.

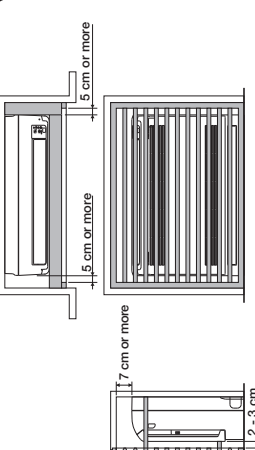
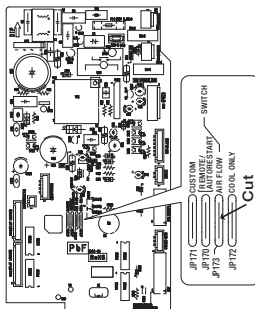

CONCERNING TERMINAL CONNECTION FOR AN INTERFACE

1. Remove the front panel and lid of control.
2. There is a terminal (respectively marked with CNS) for the indoor control board. In connecting an interface, connect to the respective terminal securely with the connection harness supplied with an option "Interface" connection kit SC-BIKN2-E" and fasten the connection harness onto the indoor control box, with the clamp supplied with the kit. For more details, please refer to the user's manual of your "Interface" connection kit SC-BIKN2-E".

INSTALLATION OF WIRELESS REMOTE CONTROL

Mounting method of battery

1. Uncover the wireless remote control, and mount the batteries [R03 (AAA, Micro), x 2 pieces] in the body regularly. (Fit the poles with the indication marks, ⊕ & ⊖ without fail)

CAUTION
Do not use new and old batteries together.

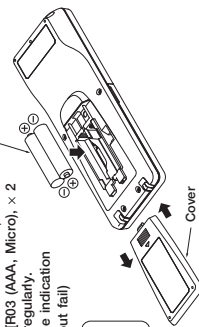

Fixing to pillar or wall

1. Conventionally, operate the wireless remote control by holding in your hand.
2. Avoid installing it on a clay wall etc.

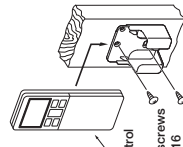

HOW TO RELOCATE OR DISPOSE OF THE UNIT

- In order to protect the environment, be sure to pump down (recovery of refrigerant).
- Pump down is the method of recovering refrigerant from the indoor unit to the outdoor unit when the pipes are removed from the unit.

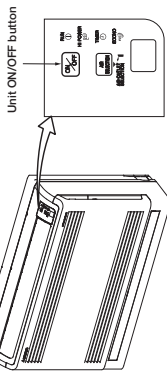

- <How to pump down>**
1. Connect charge hose to service port of outdoor unit.
 2. Liquid side: Close the liquid valve with hexagon wrench key. Gas side: Fully open the gas valve. Carry out cooling operation. (If indoor temperature is low, operate forced cooling operation.)
 3. After low pressure gauge become 0.01 MPa, stop cooling operation and close the gas valve.

INSTALLATION TEST CHECK POINTS

- After installation**
- The power source voltage is correct as the rating.
 - No gas leaks from the joints of the service valve.
 - Power cables and crossover wires are securely fixed to the terminal board.
 - The screw of the lid is tightened securely.

- Test run**
- Air-conditioning operation is normal.
 - No abnormal noise.
 - Water drains smoothly.
 - Protective functions are not working.

Check the following points again after completion of the installation, and before turning on the power. Conduct a test run again and ensure that the unit operates properly. At the same time, explain to the customer how to use the unit and how to take care of the unit following the user's manual.

- The remote control is normal.
- Operation of the unit has been explained to the customer. (Three-minutes restart preventive timer) When the air-conditioner is restarted or when changing the operation, the unit will not start operating for approximately 3 minutes. This is to protect the unit and it is not a malfunction.

(3) Ceiling concealed type (SRR)

Models SRR25ZM-W, 35ZM-W

SRR25ZS-W, 35ZS-W, 50ZS-W, 60ZS-W

⚠ CAUTION
<p>• Carry out the electrical work for ground lead with care. Do not connect the ground lead to the gas line, water line, lightning conductor or telephone line's ground lead. Incorrect grounding can cause unit faults such as electric shocks due to short-circuiting.</p> <p>• Use the circuit breaker of correct capacity. Circuit breaker should be able to disconnect all poles under over current.</p> <p>• Using the incorrect one could cause the system failure and fire.</p> <p>• Install isolator or disconnect switch on the power source wiring in accordance with the local codes and regulations.</p> <p>• EN62024 should be locked in OFF state in accordance with EN62024.</p> <p>• Be sure to install indoor unit properly according to instruction manual so that drainage can run off smoothly.</p> <p>• Improper installation of indoor unit can cause dripping water into the room and damaging personal property.</p> <p>• Install the drainage pipe to run off drainage securely according to the installation manual.</p> <p>• Incorrect installation of the drainage pipe can cause dripping water into the room and damaging personal property.</p> <p>• Be sure to install the drainage pipe with descending slope of 1/100 or more, and not to make traps and air-bleedings.</p> <p>• Check if the drainage runs off securely during commissioning and ensure the space for inspection and maintenance.</p> <p>• After maintenance, all wiring, wiring ties and the like, should be returned to their original state and wiring route, and the necessary clearance from all metal parts should be secured.</p> <p>• Secure the pipe for installation, inspection and maintenance as described in the manual.</p> <p>• Insufficient space can result in accident such as personal injury due to falling from the installation place.</p> <p>• Take care when carrying the unit by hand.</p> <p>• If the unit weighs more than 20kg, it must be carried by two or more persons. Do not carry by the plastic straps, always use the carry handle.</p> <p>• Do not install the unit in the locations listed below.</p> <ul style="list-style-type: none"> • Locations where carbon fiber, metal powder or any powder is floating. • Locations where any substances that can affect the unit such as sulphide gas, chloride gas, acid and alkaline can occur. • Locations where cosmetic or special sprays are often used. • Locations with direct exposure of oil mist and steam such as kitchen and machine plant. • Locations where any machines which generate high frequency harmonics exist. • Locations with salty atmospheres such as coastlines. • Locations with heavy snow (if installed, be sure to provide base flame and snow hood mentioned in the manual). • Locations where the unit is exposed to chimney smoke. • Locations at high altitude (more than 1000m high). • Locations with ammoniac atmospheres (e.g. organic fertilizer). • Locations with calcium chloride (e.g. snow melting agent). • Locations where heat radiation from other heat source can affect the unit. • Locations without good air circulation. • Locations with any obstacles which can prevent inlet and outlet air of the unit. • Locations where short circuit of air can occur (in case of multiple units installation). • Locations where strong air blows against the air outlet of outdoor unit. • Locations where something located above the unit could fall. • It can cause remarkable decrease in performance, corrosion and damage of components, malfunction and fire. <p>• Do not install the indoor unit in the locations listed below (Be sure to install the indoor unit according to the installation manual for each model because each indoor unit has each limitation).</p> <ul style="list-style-type: none"> • Locations with any obstacles which can prevent inlet and outlet air of the unit. • Locations where vibration can be amplified due to insufficient strength of structure. • Locations where the infrared receiver is exposed to the direct sunlight or strong light beam (in case of infrared specification unit). • Locations where ceiling is affected by high harmonics is placed (TV set or radio receiver is placed within 1m). • Locations where drainage cannot run off safely. • It can affect performance or function and etc. <p>• Do not install the unit near the location where leakage of combustible gases can occur.</p> <p>• Leaked gases accumulate around the unit, it can cause fire.</p>
<p>when carrying the unit by hand. Use gloves to minimize the risk of cuts by the aluminum fins.</p> <ul style="list-style-type: none"> • Dispose of any packing materials correctly. <p>Any remaining packing materials can cause personal injury as it contains nails and wood. And to avoid danger of suffocation, be sure to keep the materials away from children and to dispose safely. It is up to the installer to be careful not to interfere with the heat exchanger, piping flare portion or screws etc.</p> <ul style="list-style-type: none"> • Be sure to insulate the refrigerant pipes so as not to condense the ambient air moisture on them. <p>Insufficient insulation can cause condensation, which can lead to moisture damage on the ceiling, floor, furniture and any other valuables.</p> <ul style="list-style-type: none"> • When perform the air-conditioner operation (cooling or drying operation) in which ventilator is installed in the room, in this case, using the air-conditioner in parallel with the ventilator, there is the possibility that drain water may backflow in accordance with the room lapse into the negative pressure status. Therefore, set up the opening port such as incorporate the air into the room that may appropriate to ventilation (For example; Open the door a little). In addition, just as above, so set up the opening port if the room lapse into negative pressure status due to register of the wind for the room lapse apartment etc. • Be sure to performed refrigerant pipe test. <p>If the density of refrigerant exceeds the limit in the event of refrigerant leakage in the small room, lack of oxygen can occur, which can cause serious accidents.</p> <ul style="list-style-type: none"> • Do not install the unit where corrosive gas (such as sulfuric acid gas etc.) or combustible gas (such as thinner and petroleum gases) can accumulate or collect, or where volatile combustible substances are handled. <p>Corrosive gas can cause corrosion of heat exchanger, breakage of plastic parts and etc. And combustible gas can cause fire.</p> <ul style="list-style-type: none"> • Do not use the indoor unit at the place where water splashes may occur such as in bathrooms. <p>Since the indoor unit is not waterproof, it can cause electric shocks and fire.</p> <ul style="list-style-type: none"> • Do not place the unit close to the frequency harmonics. <p>Equipment such as inverters, standby generators, medical high frequency equipments and telecommunication equipments can affect the system, and cause malfunctions and breakdowns. The system can also affect medical equipment and telecommunication equipment, and obstruct its function or cause jamming.</p> <ul style="list-style-type: none"> • Do not place any variables which will be damaged by getting wet under the indoor unit. <p>When the relative humidity is higher than 80% or drainage pipe is clogged, condensation or drainage water can drop and it can cause the damage of valuables.</p> <ul style="list-style-type: none"> • Do not install the remote control at the direct sunlight. <p>It can cause malfunction or deformation of the remote control.</p> <ul style="list-style-type: none"> • Do not use any materials other than a fuse with the correct rating in the location where fuses are to be used. <p>Connecting the circuit with copper wire or other metal thread can cause unit failure and fire.</p> <ul style="list-style-type: none"> • Do not touch any buttons with wet hands. <p>It can cause electric shocks.</p> <ul style="list-style-type: none"> • Do not touch any refrigerant pipes with your hands when the system is in operation. <p>During operation, the refrigerant pipes become extremely hot or extremely cold depending the operating condition, and it can cause burn injury or frost injury.</p> <ul style="list-style-type: none"> • Do not wash the inside of the air-conditioner. <p>Water leakage and permanent damage may result. Electrical hazard exists.</p>

RJ012A003F

FOR MODEL SRR SERIES R32/R410A REFRIGERANT USED

- A wired remote control unit is supplied separately as an optional part.
- While installing the unit, be sure to check the selection of installation place, power source specifications, usage limitation (piping length, height differences between indoor and outdoor units, power source voltage etc.) and installation spaces.

SAFETY PRECAUTIONS

- Keep the installation manual together with owner's manual at a place where any user can read at any time. Moreover if necessary, ask to hand them to a new user.
- Before starting the installation work, proper precautions (using suitable protective clothing, gloves etc.) should be taken by qualified installer.
- Pay attention not to fall down the tools, etc. when installing the unit at the high position.
- If unusual noise can be heard during operation, consult the dealer.
- The meanings of "Marks" used here are shown as follows:

⚠ Never do it under any circumstances.

- This installation manual illustrates the method of installing an indoor unit.
- For electrical wiring work, see instructions set out on the backside.
- For outdoor unit installation and refrigerant piping, refer to Page 9.

- Before installation, read the "SAFETY PRECAUTIONS" carefully and strictly follow it during the installation work in order to protect yourself.
 - The precautionary items mentioned below are distinguished into two levels, **WARNING** and **CAUTION**.
 - **WARNING**: Wrong installation would cause serious consequences such as injuries or death.
 - **CAUTION**: Wrong installation might cause serious consequences depending on circumstances.
- Both mention the important items to protect your health and safety so strictly follow them by any means.
- Be sure to confirm no anomaly on the equipment by commissioning after completed installation and explain the operating methods as well as the maintenance methods of this equipment to the user according to the owner's manual.

⚠ WARNING

- **Tighten the flares nut by torque wrench with specified method**
If the flares nut is loosened with excess torque, this may cause burst and refrigerant leakage after a long period.
- **The electrical installation must be carried out by the qualified electrician in accordance with "the norm for electrical work" and "national wiring regulation", and the system must be connected to the dedicated circuit.**
Power source with insufficient capacity and incorrect function done by improper work can cause electric shocks and fire.
- **Be sure to shut off the power before starting electrical work.**
Failure to shut off the power can cause electric shocks, unit failure or incorrect function of equipment.
- **Be sure to use the cables conformed to safety standard and cable ampacity for power distribution work.**
Unconformable cables can cause electric leak, anomalous heat production or fire.
- **This appliance must be connected to main power source by means of a circuit breaker or switch (fuse:16A) with a contact separation of 3mm.**
- **When plugging this appliance, a plug conforming to the norm IEC60884-1 must be used.**
- **Use the prescribed cables for electrical connection, tighten the cables securely in terminal block and relieve the cables correctly to prevent overloading the terminal blocks.**
Loose connections or cable mountings can cause anomalous heat production or fire.
- **Arrange the wiring in the control box so that it cannot be pushed up further into the box. Install the service panel correctly.**
Incorrect installation may result in overheating and fire.
- **Be sure to switch off the power source in the event of installation, inspection or servicing.**
If the power source is not shut off, there is a risk of electric shocks, unit failure or personal injury due to the unexpected start of fan.
- **Be sure to wear protective goggles and gloves while at work.**
Earrr leakage breaker must be installed.
If the earrr leakage breaker is not installed, it can cause electric shocks.
- **Do not bundle or wind or process the power cord. Do not deform the power cord by treating it.**
This may cause fire or heating.
- **Do not vent R32 or R410A into atmosphere.**
R32 is a fluorinated greenhouse gas with a Global Warming Potential (GWP) = 675. R410A is a fluorinated greenhouse gas with a Global Warming Potential (GWP) = 2088.
- **Do not run the unit with removed panels or protections.**
Touching rotating equipments, hot surfaces or high voltage parts can cause personal injury due to entrapment, burn or electric shocks.
- **Do not perform any change of protective device itself or its setup**
The forced operation by short-circuiting protective device of pressure switch and temperature controller or the use of non specified component can cause fire or burst.
- **Installation must be carried out by the qualified installer.**
If the installer is not a qualified person, serious accidents such as water leaks, electric shocks, fire and personal injury as a result of a system malfunction. Do not carry out the installation and maintenance work except the by qualified installer.
- **Install the system in full accordance with the installation manual.**
Incorrect installation may cause bursts, personal injury, water leaks, electric shocks and fire.
- **Be sure to use only for household and residence.**
If this appliance is installed in interior environment such as machine shop and etc., it can cause malfunction.
- **Use the original accessories and the specified components for installation.**
If parts other than those prescribed by us are used, it may cause water leaks, electric shocks, fire and personal injury.
- **Install the unit in a location with good support.**
Unsuitable installation locations can cause the unit to fall resulting in personal damage and personal injury.
- **Use the specified area well in the event of refrigerant leakage during installation.**
If the refrigerant comes into contact with naked flames, poisonous gas is produced.
- **When installing in small rooms, take prevention measures not to exceed the density limit of refrigerant in the event of leakage.**
If the density of refrigerant exceeds the limit, consult the dealer and install the ventilation system, otherwise lack of oxygen can occur, which can cause serious accident.
- **After completing installation, check that no refrigerant leaks from the system.**
If refrigerant leaks into the room and comes into contact with an oven or other hot surface, poisonous gas is produced.
- **Use the prescribed pipes, flare nuts and tools for R32 or R410A.**
Using existing parts (for R22 or R407C) can cause the unit failure and serious accidents due to burst of the refrigerant circuit.
- **Do not put the drainage pipe directly into drainage channels where poisonous gases such as sulphide gas can occur.**
Poisonous gases will flow into the room through drainage pipe and seriously affect the user's health and safety. This can also cause the corrosion of the indoor unit and a resultant unit failure or refrigerant leak.
- **Install that no air enters in the refrigerant circuit when the unit is installed and removed.**
If air enters in the refrigerant circuit, the pressure in the refrigerant circuit becomes too high, which can cause burst and personal injury.
- **Do not touch or replace the power cord, or share the socket with other power plugs.**
This may cause fire or electric shock due to deflecting contact, deflecting insulation and over-current etc.

Check before installation work

- Model name and power source
- Refrigerant piping length
- Piping, wiring and miscellaneous small parts

Standard accessories (Installation kit)		Qty
Accessories for indoor unit		
①	Wireless remote control	1
②	Remote control holder	1
③	Remote control signal receiver	1
④	Installation frame (for remote control signal receiver)	1
⑤	Wood screws	2
⑥	Battery (R03 (AAA, Micro) 1.5V)	2
⑦	Joint (for drain hose)	2
⑧	Clamp (for drain hose) (big:1, small:1)	2
⑨	Washer (for suspension bolt M10)	8
⑩	Flat head machine screw (for remote control signal receiver M3.5x10)	2
⑪	Plate (display)	1
⑫	Pipe cover (big:1, small:1)	2
⑬	Band	4

Locally procured parts		Qty
Ⓐ	Sealing plate	1
Ⓑ	Sleeve	1
Ⓒ	Inclination plate	1
Ⓓ	Pully	1
Ⓔ	Drain hose (VP25)	1
Ⓕ	Suspension bolts (M10)	4
Ⓖ	Nuts (M10)	8
Ⓗ	Spring lock washers (M10)	4

Option parts (Separately sold parts)		Qty
Bottom air inlet kit (25, 35 models : UT-BAT1EF (50, 60 models : UT-BAT2EF)		1

Necessary tools for the installation work	
1	Plus headed driver
2	Knife
3	Saw
4	Tape measure
5	Hammer
6	Spanner wrench
7	Torque wrench [14, 0-62.0N·m (1.4-6.2kgf·m)]
8	Hole core drill (65mm in diameter)
9	Wrench key (Hexagon) [mm]
10	Flaring tool set (Designed specifically for R32 or R410A)
11	Gas leak detector (Designed specifically for R32 or R410A)
12	Gauge for projection adjustment (Used when flare is made by using conventional flare tool)
13	Pipe bender

SELECTION OF INSTALLATION LOCATION
(Install at location that meets the following conditions, after getting approval from the customer)

Indoor unit

- Where there is no obstructions to the air flow and where the cooled and heated air can be evenly distributed.
- A firm location that may sustain the weight of the unit, and do not cause the unit or the ceiling to vibrate.
- A place where there will be enough space for servicing. (Where space mentioned below can be secured)
- A place where the unit is not exposed to direct rays of the sun or the strong rays of the street lighting.
- The place where receiving part is not exposed to the direct rays of the sun or the strong rays of the street lighting.
- A place separated at least 1m away from the television or the radio. (To prevent interference to images and sounds.)
- A place where this unit is not affected by the high frequency equipment or electric equipment.
- Do not install this unit in place where there is much oil mist.
- Place the indoor unit in a place where there is no direct sunlight or rain when installing, or where the suction inlet of the unit is located far from the air inlet on the ceiling, the entire inside of ceiling acts as an air suction duct so that the capacity is reduced at the startup.
- Areas where dew point is lower than around 28°C and relative humidity is lower than 80%.
- This indoor unit is tested under the condition of JIS (Japan Industrial Standard) high humidity condition and confirmed there is no problem. However, there is some risk of condensation drop if the air-conditioner is operated under the severer condition than mentioned above.
- If there is a possibility to use tandem such a condition, attach additional insulation of 10 to 20mm thick for entire surface of indoor unit, refrigeration pipe and drain pipe.
- Excessive static pressure can cause the trouble of insufficient performance due to less air flow. It is recommended to use the products with a few meters straight duct connected to either air intake or air blowout port only at maximum. (As for the permitted external static pressure, please confirm the Technical manual.)

Wireless remote control

- A place where the air-conditioner can be received the signal surely during operating the wireless remote control.
- A place where there is no affected by the TV and radio etc.
- Do not place where exposed to direct sunlight or near heat devices such as a stove.

Space for installation and service

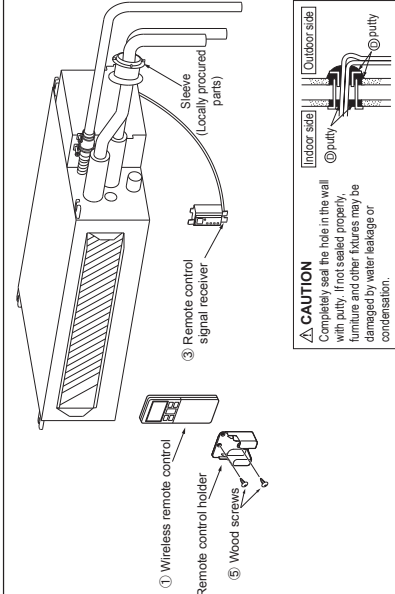
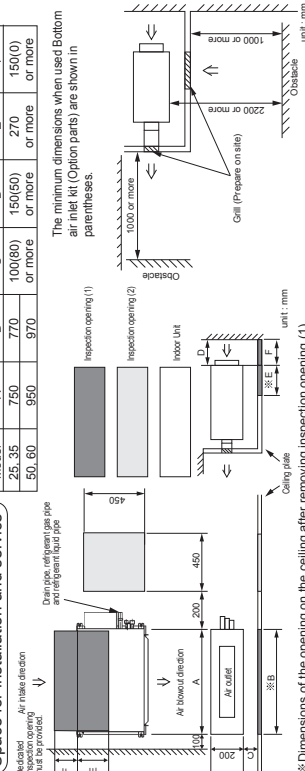

Inspection opening for services

Service	Inspection opening (1)	Inspection opening (2)
Clamping of the flare of required and gas refrigerant pipe	Not Use	Use
Drain pipe connection	Not Use	Use
Installation and removal of blower	Use	Not Use
Control box		
Connecting wire (between indoor and outdoor)	Not Use	Use
Unit display section (Remote control signal receiver)	Not Use	Use
Replace drain pump	Not Use	Use
Replace heat exch sensor	Not Use	Use
Replace air filter	Use	Not Use

INSTALLATION OF INDOOR UNIT

- Remove bracket from the unit after unpacking according to process as shown below.
- (1) Loosen 2 screws.
- (2) Remove bracket.
- (3) Tighten the screws.

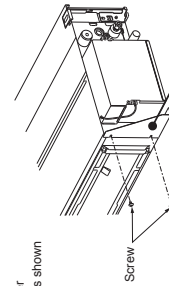

Suspension Bolt Location

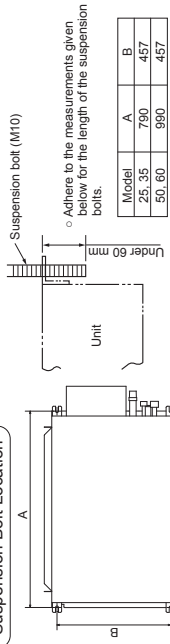

Drilling of hole and fixture of sleeve (Locally procured parts)

When drilling the wall that contains a metal lath, wire lath or metal plate, be sure to use pipe hole sleeve sold separately.

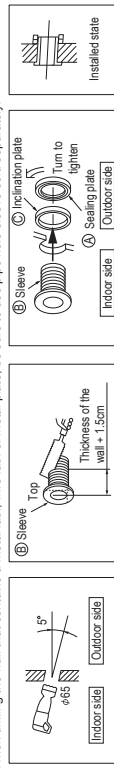

In case of rear piping draw out, cut of the lower and the right side portions of the sleeve collar.

* Sleeve is for use in refrigerant piping work. Please install another pipe separately for drain piping work.

Pipe locations

All models

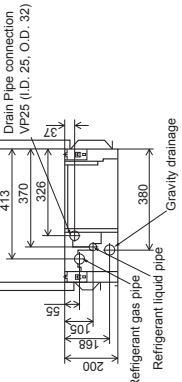

INSTALLATION OF INDOOR UNIT

Installing the main unit

- Attach the washers and nuts to the suspension bolts.
 - Attach the hanging tool to the above nuts, and tighten the nuts.
-

Securing the suspension bolts

- If steel embedded ceiling
-

- Secure the suspension bolts firmly following the illustrations and other instructions.

Adjustment for horizontality

- Either use a level vial, or adjust the level according to the method below.
-
- Adjust so the bottom side of the unit will be leveled with the water surface as illustrated below.

- If the unit is not leveled, it may cause malfunctions or inoperation of the float switch.

Air inlet and outlet size

- Size of air inlet and outlet of the plate.

Model	A	B
25_35	160	99
50_60	160	860

unit: mm

CONNECTION OF REFRIGERANT PIPINGS

- Preparation Keep the openings of the pipes covered with tapes etc. to prevent dust, sand, etc. from entering them.

Indoor

- Do not turn
-

- Remove the flared nuts (on both liquid and gas sides)

Flaring work

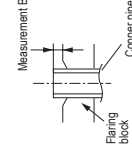

Copper pipe diameter	Measurement B (mm)	
	Conventional (R22) flare tool	Vingrut type
φ6.35	0.0~0.5	1.0~1.5
φ9.52	0.0~0.5	1.0~1.5
φ12.7	0.0~0.5	2.0~2.5

Use a flare tool designed for R32, R410A or a conventional flare tool.
Note that measurement B (protusion from the flaring block) will vary depending on the type of a flare tool in use.
If a conventional flare tool is used, use a copper pipe gauge or a similar instrument to check protusion so that you can keep measurement B to a correct value.

Indoor

- Do not turn

- Connect the pipes on both liquid and gas sides.

- Tighten the nuts to the following torque.

- Liquid side (φ6.35): 1.40 - 1.60 Nm (1.4 - 1.8 kgf-m)
- Gas side (φ9.52): 3.40 - 4.20 Nm (3.4 - 4.2 kgf-m)
- Gas side (φ12.7): 4.90 - 6.10 Nm (4.9 - 6.1 kgf-m)

CAUTION

- Do not apply excess torque to the flared nuts. Otherwise, the flared nuts may crack.

Connection

Indoor



- Connect the pipes on both liquid and gas sides.

- Tighten the nuts to the following torque.

- Liquid side (φ6.35): 1.40 - 1.60 Nm (1.4 - 1.8 kgf-m)
- Gas side (φ9.52): 3.40 - 4.20 Nm (3.4 - 4.2 kgf-m)
- Gas side (φ12.7): 4.90 - 6.10 Nm (4.9 - 6.1 kgf-m)

CAUTION

- Do not apply excess torque to the flared nuts. Otherwise, the flared nuts may crack.

- Cover the flare connection part of the indoor unit with attached insulation material after a gas leakage inspection, and tighten both ends with attached bands.

- Make sure to insulate both gas pipes and liquid pipes completely.
- (Incomplete insulation may cause dew condensation or water dropping.
- Use heat-resistant (120 °C or more) insulations on the gas side pipes.
- In case of using at high humidity condition, reinforce insulation of refrigerant pipes. Surface of insulation may cause dew condensation or water dropping, if insulations are not reinforced.

- The case of using reinforced insulations

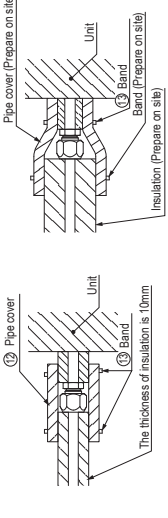

- The case of using reinforced insulations

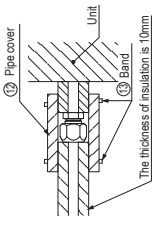

DRAIN PIPE

- Install the drain pipe according to the installation manual in order to drain properly.
- Imperfection in draining may cause food indoors and wetting the household goods, etc.
- Do not put the drain pipe directly into the ditch where toxic gas such as sulfur, the other harmful and inflammable gas is generated. Toxic gas would flow into the room and it would cause serious damage to user's health and safety (some poisoning or deficiency of oxygen). In addition, it may cause corrosion of heat exchanger and bad smell.
- Connect the pipe securely to a void water leakage from the joint.
- Insulate the pipe properly to avoid condensation drop.
- Check if the water can flow out properly from both the drain outlet on the indoor unit and the end of the drain pipe after installation.

Work procedure

- (1) Insert the joint to the drain hose on the indoor unit and fix it securely with the clamp (small).
 - Do not apply adhesives on this end.
- (2) Connect the drain pipe (VP25) to the joint and fix it securely with the clamp (big).
- (3) Make sure to make descending slope of greater than 1/100 and do not make up-down bend and/or trap in the midway.
 - Pay attention not to give stress on the pipe on the indoor unit side, and support and fix the pipe as close place to the unit as possible when connecting the drain pipe.
 - Do not set up air vent.

Drain up

- The position for drain pipe outlet can be raised up to 600mm above the ceiling. Use elbows for installation to avoid obstacles inside ceiling. If the horizontal drain pipe is too long before vertical pipe, the backflow of water will increase when the unit is stopped, and it may cause overflow of water from the drain pan on the indoor unit. In order to avoid overflow, keep the horizontal pipe length and offset of the pipe within the limit shown in the figure below.

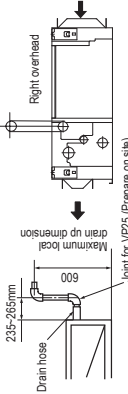

Drain test

- Conduct a drainage test after completion of the electrical work and piping work.
- During the trial, make sure that drain flows properly through the piping and that no water leaks from connections.
- In case of a new building, conduct the test before it is furnished with the ceiling.
- Be sure to conduct this test even when the unit is installed in the heating season.

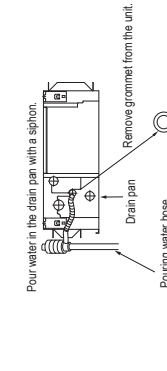

Procedures of drain test

- (1) Supply about 1000 cc of water to the unit through the air outlet by using a feed water pump.
- (2) Check the drain while cooling operation.

Outline of bottom drain piping work

- If the bottom drain piping can be done with a descending gradient (1/50-1/100), it is possible to connect the pipes as shown in the drawing below.

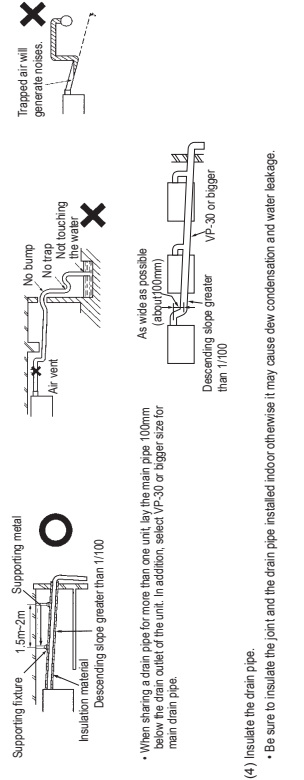

- (4) Insulate the drain pipe.
 - Be sure to insulate the joint and the drain pipe installed indoor otherwise it may cause dew condensation and water leakage.

ELECTRICAL WIRING WORK

Preparation of indoor unit ○ In case of faulty wiring connection, indoor unit does not operate. Then, run lamp turns on and timer lamp blinks.

Mounting of connecting wires

- Remove the control lid.
- Remove the wiring clamp.
- Connect the connecting wire to the terminal block.
 - Connect the connection wire securely. If the wire is not affixed completely, contact will be poor, and it is dangerous as the terminal block may heat up and catch fire.
 - Take care not to confuse the terminal numbers for indoor and outdoor connections.
 - Fix the connecting wire by wiring clamp.
 - Connect the connector of the remote control signal receiver to the relay wiring.
 - Attach the control lid.

Be sure to connect earth wire shall be Yellow/Green (Y/G) in color and longer than other A/C wires for safety reason.

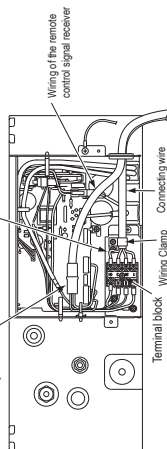

Securing the remote control signal receiver

- Plate (display)
- Flat head machine screw (in the pack of ①)
- Remote control signal receiver
- Installation frame
- Fix the plate (display) ① on the installation frame ④ using the flat head machine screws packed together with the plate (display) ①.
- Insert the remote control signal receiver ③ in the installation frame ④, and fix the calking section.
- Fix the installation frame ④ on the wall using the flat head machine screws ②.

- Open a through-hole on the wall to install the reception face for the remote control signal receiver ③.
- Insert the remote control signal receiver ③ in the installation frame ④, and fix the calking section.
- Fix the installation frame ④ on the wall using the flat head machine screws ②.
- Fix the plate (display) ① on the installation frame ④ using the flat head machine screws packed together with the plate (display) ①.

Flat head machine screw (in the pack of ①)
48 x 75mm

Use cables for interconnection wiring to avoid loosening of the wires.
GENERAL code for cables Required field cables.

- H05RN1G-1.5 (example) or 245IEC57
- H Harmonized cable type
- G5 30/50 volts
- N Natural-insulator synth. rubber wire insulation
- R Nylon-impregnated rubber conductor's insulation
- S Stranded
- 4c×5 Number of conductors
- G One conductor of the cable is the earth conductor (yellow/green)
- 1.5 Section of copper wire (mm²)

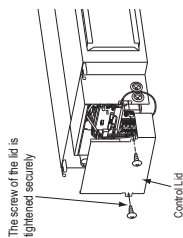

INSTALLING TWO AIR-CONDITIONERS IN THE SAME ROOM

When two air-conditioners are installed in the same room, use this setting when the two air-conditioners are not operated with one remote control. Set the remote control and indoor unit.

Setting the remote control

- Pull out the cover and take out batteries.
- Disconnect the switching line next to the battery with wire cutters.

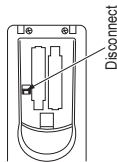

- Insert batteries. Close the cover.

Setting an indoor unit

- Turn off the power source, and turn it on after 1 minute.
- Point the remote control that was set according to the procedure described on the left side at the unit display section and send a signal by pressing the ACL switch on the remote control.
Since the signal is sent in about 6 seconds after the ACL switch is pressed, point the remote control at the unit display section for some time.
- Check that the reception buzzer sound "Peep" is emitted from the indoor unit.
At completion of the setting, the indoor unit emits a buzzer sound "Peep". (If no reception tone is emitted, start the setting from the beginning again.)

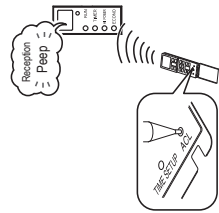

HOW TO RELOCATE OR DISPOSE OF THE UNIT

- In order to protect the environment, be sure to pump down (recovery of refrigerant).
 - Forced cooling operation
- Pump down is the method of recovering refrigerant from the indoor unit to the outdoor unit when the pipes are removed from the unit.
 - Turn off power source. Turn on power source again after a while. Then, press the ON/OFF button continuously for at least 5 seconds. (The operation will start.)

<How to pump down>

- Connect charge hose to check joint of outdoor unit.
- Liquid side: Close the liquid valve with hexagon wrench key.
Gas side: Fully open the gas valve.
Carry out cooling operation. (If indoor temperature is low, operate forced cooling operation.)
- After low pressure gauge become 0.01MPa, stop cooling operation and close the gas valve.

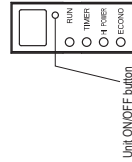

TERMINAL CONNECTION FOR AN INTERFACE

- Remove the control lid. (Remove the screw.)
- There is a terminal (respectively marked with Q/S) for the indoor control board. In connecting an interface, connect to the respective terminal securely with an optional "interface connection kit SC-BKN2-E and SC-BKN2-E" and fasten the connection harness onto the indoor control box with the clamp supplied with the kit.
For more details, please refer to the user's manual of your "interface connection kit SC-BKN-E and SC-BKN2-E".

INSTALLATION TEST CHECK POINTS

Check the following points again after completion of the installation, and before turning on the power. Conduct a test run again and ensure that the unit operates properly. Explain to the customer how to use the unit and how to take care of the unit following the installation manual.

After installation

- Power cables and connecting wires are securely fixed to the terminal block. (Both indoor and outdoor)
- The power source voltage is correct as the rating.
- The drain hose is fixed securely.
- Service valve is fully open.
- No gas leaks from the joints of the service valve.
- The pipe joints for indoor and outdoor pipes have been insulated.
- The screw of the control lid is tightened securely.

Test run

- Air-conditioning operation is normal.
- No abnormal noise.
- Water drains smoothly.
- Protective functions are not working.
- The remote control is normal.
- Operation of the unit has been explained to the customer. (Three minutes restart preventive timer)
- When the air conditioner is restarted or when changing the operation, the unit will not start operating for approximately 3 minutes. This is to protect the unit and it is not a malfunction.

INSTALLATION OF WIRELESS REMOTE CONTROL

Mounting method of battery

- Pull out the cover and mount the batteries (R03 (AAA, Micro) X 2 pieces) in the body regularly. (Fit the poles with the indication marks, ⊕ & ⊖ without fail)
- Do not use new and old batteries together.

Fixing to pillar or wall

- Conventionally, operate the wireless remote control by holding in your hand.
- Avoid installing it on a clay wall etc.

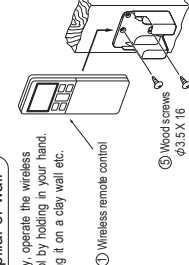

(4) 4-way ceiling cassette type (FDTC)

Models FDTC25VH1, 25VH, 35VH1, 35VH, 50VH, 60VH

PJF012D514

This manual is for the installation of the indoor unit.
 For electrical wiring work (Indoor), refer to page 211.
 For wired remote control installation, refer to page 227. For wireless kit installation, refer to page 246.
 For electrical wiring work (Outdoor unit) and refrigerant pipe work installation for outdoor unit, refer to page 9. For motion sensor kit installation, refer to page 274. This unit must always be used with the panel.

SAFETY PRECAUTIONS

- Read the "SAFETY PRECAUTIONS" carefully first of all and then strictly follow it during the installation work in order to protect yourself.
- The precautionary items mentioned below are distinguished into two levels, **⚠ WARNING** and **⚠ CAUTION**.
⚠ WARNING: Wrong installation would cause serious consequences such as injuries or death.
⚠ CAUTION: Wrong installation might cause serious consequences depending on circumstances.
 Both mentions the important items to protect your health and safety so strictly follow them by any means.
- The meanings of "Marks" used here are as shown on the right:
 ⓧ Never do it under any circumstances. ⚠ Always do it according to the instruction.
- After completing the installation, do commissioning to confirm there are no abnormalities, and explain to the customers about "SAFETY PRECAUTIONS", correct operation method and maintenance method (air filter cleaning, operation method and temperature setting method) with user's manual of this unit.
 Ask your customers to keep this installation manual together with the user's manual. Also, ask them to hand over the user's manual to the new user when the owner is changed.

⚠ WARNING

- **Installation should be performed by the specialist.** ⚠
 If you install the unit by yourself, it may lead to serious trouble such as water leakage, electric shock, fire, and injury due to overturn of the unit.
- **Install the system correctly according to these installation manuals.** ⚠
 Improper installation may cause explosion, injury, water leakage, electric shock, and fire.
- **Check the density referred by the formula (accordance with ISO5149).** ⚠
 If the density exceeds the limit density, please consult the dealer and installate the ventilation system.
- **Use the genuine accessories and the specified parts for installation.** ⚠
 If parts unspecified by our company are used it could cause water leakage, electric shock, fire, and injury due to overturn of the unit.
- **Ventilate the working area well in case the refrigerant leaks during installation.** ⚠
 If the refrigerant contacts the fire, toxic gas is produced.
 In case of R32, the refrigerant could be ignited because of its flammability.
- **Install the unit in a location that can hold heavy weight.** ⚠
 Improper installation may cause the unit to fall leading to accidents.
- **Install the unit properly in order to be able to withstand strong winds such as typhoons, and earthquakes.** ⚠
 Improper installation may cause the unit to fall leading to accidents.
- **Do not mix air in to the cooling cycle on installation or removal of the air conditioner.** ⚠
 If air is mixed in, the pressure in the cooling cycle will rise abnormally and may cause explosion and injuries.
- **Be sure to have the electrical wiring work done by qualified electrical installer, and use exclusive circuit.** ⚠
 Power source with insufficient capacity and improper work can cause electric shock and fire.
- **Use specified wire for electrical wiring, fasten the wire to the terminal securely, and hold the cable securely in order not to apply unexpected stress on the terminal.** ⚠
 Loose connections or hold could result in abnormal heat generation or fire.
- **Arrange the electrical wires in the control box properly to prevent them from rising. Fit the lid of the services panel properly.** ⚠
 Improper fitting may cause abnormal heat and fire.
- **Check for refrigerant gas leakage after installation is completed.** ⚠
 If the refrigerant gas leaks into the house and comes in contact with a fan heater, a stove, or an oven, toxic gas is produced.
- **Use the specified pipe, flare nut, and tools for R32 or R410A.** ⚠
 Using existing parts (R22) could cause the unit failure and serious accident due to explosion of the cooling cycle.
- **Tighten the flare nut according to the specified method by with torque wrench.** ⚠
 If the flare nut were tightened with excess torque, it could cause burst and refrigerant leakage after a long period.
- **Do not put the drainage pipe directly into drainage channels where poisonous gases such as sulfide gas can occur.** ⚠
 Poisonous gases will flow into the room through drainage pipe and seriously affect the user's health and safety. This can also cause the corrosion of the indoor unit and a resultant unit failure or refrigerant leak.
- **Connect the pipes for refrigeration circuit securely in installation work before compressor is operated.** ⚠
 If the compressor is operated when the service valve is open without connecting the pipe, it could cause explosion and injuries due to abnormal high pressure in the system.
- **Stop the compressor before removing the pipe after shutting the service valve on pump down work.** ⚠
 If the pipe is removed when the compressor is in operation with the service valve open, air would be mixed in the refrigeration circuit and it could cause explosion and injuries due to abnormal high pressure in the cooling cycle.
- **Only use prescribed optional parts. The installation must be carried out by the qualified installer.** ⚠
 If you install the system by yourself, it can cause serious trouble such as water leaks, electric shocks, fire.
- **Do not repair by yourself. And consult with the dealer about repair.** ⚠
 Improper repair may cause water leakage, electric shock or fire.
- **Consult the dealer or a specialist about removal of the air conditioner.** ⚠
 Improper installation may cause water leakage, electric shock or fire.
- **Turn off the power source during servicing or inspection work.** ⚠
 If the power is supplied during servicing or inspection work, it could cause electric shock and injury by the operating fan.
- **Do not run the unit when the panel or protection guard are taken off.** ⚠
 Touching the rotating equipment, hot surface, or high voltage section could cause an injury to be caught in the machine, to get burned, or electric shock.
- **Shut off the power before electrical wiring work.** ⚠
 It could cause electric shock, unit failure and improper running.

⚠ CAUTION

- **Perform earth wiring surely.** ⚠
 Do not connect the earth wiring to the gas pipe, water pipe, lightning rod and telephone earth wiring. Improper earth could cause unit failure and electric shock due to a short circuit.
- **Earth leakage breaker must be installed.** ⚠
 If the earth leakage breaker is not installed, it can cause electric shocks.
- **Use the circuit breaker of correct capacity. Circuit breaker should be the one that disconnect all poles under over current.** ⚠
 Using the incorrect one could cause the system failure and fire.
- **Do not use any materials other than a fuse of correct capacity where a fuse should be used.** ⚠
 Connecting the circuit by wire or copper wire could cause unit failure and fire.
- **Do not install the indoor unit near the location where there is possibility of flammable gas leakages.** ⚠
 If the gas leaks and gathers around the unit, it could cause fire.
- **Do not install and use the unit where corrosive gas (such as sulfurous acid gas etc.) or flammable gas (such as thinner, petroleum etc.) may be generated or accumulated, it could be sprayed with chemicals, or volatile flammable substances are handled.** ⚠
 It could cause the corrosion of heat exchanger, breakage of plastic parts etc. And inflammable gas could cause fire.
- **Secure a space for installation, inspection and maintenance specified in the manual.** ⚠
 Insufficient space can result in accident such as personal injury due to falling from the installation place.
- **Do not use the indoor unit at the place where water splashes such as laundry.** ⚠
 Indoor unit is not waterproof. It could cause electric shock and fire.
- **Do not use the indoor unit for a special purpose such as food storage, cooling for precision instrument, preservation of animals, plants, and a work of art.** ⚠
 It could cause the damage of the items.
- **Do not install nor use the system near equipments which generate electromagnetic wave or high harmonics.** ⚠
 Equipments like inverter equipment, private power generator, high-frequency medical equipment, or telecommunication equipment might influence the air conditioner and cause a malfunction and breakdown. Or the air conditioner might influence medical equipments or telecommunication equipments, and obstruct their medical activity or cause jamming.
- **Do not install the remote control at the direct sunlight.** ⚠
 It could cause breakdown or deformation of the remote control.
- **Do not install the indoor unit at the place listed below.** ⚠
 - Places where flammable gas could leak.
 - Places where carbon fiber, metal powder or any powder is floated.
 - Place where the substances which affect the air conditioner are generated such as sulfide gas, chloride gas, acid, alkali or ammoniac atmospheres.
 - Places exposed to oil mist or steam directly.
 - On vehicles and ships
 - Places where machinery which generates high harmonics is used.
 - Places where cosmetics or special sprays are frequently used.
 - Highly salted area such as beach.
 - Heavy snow area
 - Places where the system is affected by smoke from a chimney.
 - Altitude over 1000m
- **Do not install the indoor unit in the locations listed below (Be sure to install the indoor unit according to the installation manual for each model because each indoor unit has each limitation)** ⚠
 - Locations with any obstacles which can prevent inlet and outlet air of the unit
 - Locations where vibration can be amplified due to insufficient strength of structure.
 - Locations where the infrared receiver is exposed to the direct sunlight or the strong light beam. (in case of the infrared specification unit)
 - Locations where an equipment affected by high harmonics is placed. (TV set or radio receiver is placed within 5m)
 - Locations where drainage cannot run off safely. It can affect performance or function and etc..
 - Do not install the motion sensor mounting panel at following places. It could cause detection error, incapacity of detection, or characteristic degradation.
 - Place where vibration is applied to it for a long period of time.
 - Place where static electricity or electromagnetic wave generates.
 - Place where it is exposed to high temperature or humidity for a long period of time.
 - Dusty place or where the lens face could be fouled or damaged.
- **Do not put any valuables which will break down by getting wet under the air conditioner.** ⚠
 Condensation could drop when the relative humidity is higher than 80% or drain pipe is clogged, and it damages user's belongings.
- **Do not use the base frame for the outdoor unit which is corroded or damaged after a long period of use.** ⚠
 It could cause the unit falling down and injury.
- **Pay attention not to damage the drain pan by weld sputter when brazing work is done near the unit.** ⚠
 If sputter entered into the unit during brazing work, it could cause damage (pinhole) of drain pan and leakage of water. To avoid damaging, keep the indoor unit packed or cover the indoor unit.
- **Install the drain pipe to drain the water surely according to the installation manual.** ⚠
 Water may drip in the room, damaging user's belongings, unless it is worked as instructed.
- **Be sure to perform air tightness test by pressurizing with nitrogen gas after completed refrigerant piping work.** ⚠
 If the density of refrigerant exceeds the limit in the event of refrigerant leakage in the small room, lack of oxygen can occur, which can cause serious accidents.
- **For drain pipe installation, be sure to make descending slope of greater than 1/100, not to make traps, and not to make air-bleeding.** ⚠
 Check if the drainage is correctly done during commissioning and ensure the space for inspection and maintenance.
- **Ensure the insulation on the pipes for refrigeration circuit so as not to condense water.** ⚠
 Incomplete insulation could cause condensation and it would wet ceiling, floor, and any other valuables.
- **Do not install the outdoor unit where is likely to be a nest for insects and small animals.** ⚠
 Insects and small animals could come into the electronic components and cause breakdown and fire. Instruct the user to keep the surroundings clean.
- **Pay extra attention, carrying the unit by hand.** ⚠
 Carry the unit with 2 people if it is heavier than 20kg. Do not use the plastic straps but the grabbing place, moving the unit by hand. Use protective gloves in order to avoid injury.
- **Make sure to dispose of the packaging material.** ⚠
 Leaving the materials may cause injury as metals like nail and woods are used in the package.
- **Do not operate the system without the air filter.** ⚠
 It may cause the breakdown of the system due to clogging of the heat exchanger.
- **Do not touch any button with wet hands.** ⚠
 It could cause electric shock.
- **Do not touch the refrigerant piping with bare hands when in operation.** ⚠
 The pipe during operation would become very hot or cold according to the operating condition, and it could cause a burn or frostbite.
- **Do not clean up the air conditioner with water, and do not spray disinfectants etc. directly over the air conditioner.** ⚠
 It could cause electrical shock or corrode parts.
- **Do not turn off the power source immediately after stopping the operation.** ⚠
 Be sure to wait for more than 5 minutes. Otherwise it could cause water leakage or breakdown.
- **Do not control the operation with the circuit breaker.** ⚠
 It could cause fire or water leakage. In addition, the fan may start operation unexpectedly and it may cause injury.

① Before installation

- Install correctly according to the installation manual.
- Confirm the following points:
 - Unit type/Power supply specification
 - Pipes/Wires/Small parts
 - Accessory items

When moving the indoor unit, hold only the hanging hardware (4 places) only, with care not to apply forces to any other parts of the unit (particularly the refrigerant pipe, drain pipe, and resin parts).

Accessory item

For unit hanging		For refrigerant pipe			For drain pipe			
Flat washer (M10)	Level gauge	Pipe cover(big)	Pipe cover (small)	Strap	Pipe cover(big)	Pipe cover(small)	Drain hose	Hose clamp
8	1	1	1	4	1	1	1	1
For unit hanging	For ceiling adjustment or leveling	For heat insulation of gas pipe	For heat insulation of liquid tube	For pipe cover fixing	For heat insulation of drain socket	For heat insulation of drain socket	For drain pipe connecting	For drain hose mounting

② Selection of installation location for the indoor unit

- Select the suitable areas to install the unit under approval of the user.
 - Areas where the indoor unit can deliver hot and cold wind sufficiently. Suggest to the user to use a circulator if the ceiling height is over 3m to avoid warm air being accumulated on the ceiling.
 - In case of the panel having the motion sensor, the installation height must be no higher than 4 m. It could reduce the sensitivity of motion sensor, disabling the detection.
 - Areas where there is enough space to install and service.
 - Areas where it can be drained properly. Areas where drain pipe descending slope can be taken.
 - Areas where there is no obstruction of airflow on both air return grille and air supply port.
 - Areas where fire alarm will not be accidentally activated by the air conditioner.
 - Areas where the supply air does not short-circuit.
 - Areas where it is not influenced by draft air.
 - Areas not exposed to direct sunlight.
 - Areas where dew point is lower than around 28°C and relative humidity is lower than 80%.
 (This indoor unit is tested under the condition of JIS (Japan Industrial Standard) high humidity condition and confirmed there is no problem. However, there is some risk of condensation drop if the air conditioner is operated under the severer condition than mentioned above. If there is a possibility to use it under such a condition, attach additional insulation of 10 to 20mm thick for entire surface of indoor unit, refrigeration pipe and drain pipe.)
 - Areas where TV and radio stays away more than 1m. (It could cause jamming and noise.)
 - Areas where any items which will be damaged by getting wet are not placed such as food, table wares, server, or medical equipment under the unit.
 - Areas where there is no influence by the heat which cookware generates.
 - Areas where not exposed to oil mist, powder and/or steam directly such as above fryer.
 - Areas where lighting device such as fluorescent light or incandescent light doesn't affect the operation.
 (A beam from lighting device sometimes affects the infrared receiver for the wireless remote control and the air conditioner might not work properly.)
- Check if the place where the air conditioner is installed can hold the weight of the unit. If it is not able to hold, reinforce the structure with boards and beams strong enough to hold it. If the strength is not enough, it could cause injury due to unit falling.
- If there are 2 units of wireless type, keep them away for more than 6m to avoid malfunction due to cross communication.
- When plural indoor units are installed nearby, keep them away for more than 4m.

Space for installation and service

- When it is not possible to keep enough space between indoor unit and wall or between indoor units, close the air supply port where it is not possible to keep space and confirm there is no short circuit of airflow.
- Install the indoor unit at a height of more than 2.5m above the floor.

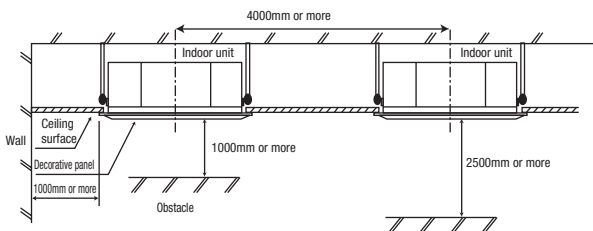

Set blow-out pattern

- Select the most proper number of blow-out air supply port direction from 4 way, 3 way or 2 way according to the shape of the room and installation position. (1 way is not available.)
- If it is necessary to change the number of air supply port, prepare the covering materials. (sold as accessory)
- Instruct the user not to use low fan speed when 2way or 3way air supply is used.
- Do not use 2way air supply port under high temperature and humidity environment. (Otherwise it could cause condensation and leakage of water.)
- It is possible to set the airflow direction port by port independently. Refer to the user's manual for details.

Where there are pipe joints on the way of embedded piping, provide adequate openings for inspection of the joints.

③ Preparation before installation

- If suspension bolt becomes longer, do reinforcement of earthquake resistant.
 - For grid ceiling
 When suspension bolt length is over 500mm, or the gap between the ceiling and roof is over 700mm, apply earthquake resistant brace to the bolt.
 - In case the unit is hanged directly from the slab and is installed on the ceiling plane which has enough strength.
 When suspension bolt length is over 1000mm, apply the earthquake resistant brace to the bolt.
- Prepare four (4) sets of suspension bolt, nut and spring washer (M10 or M8) on site.

Ceiling opening, Suspension bolts pitch, Pipe position

Symbol	Content
A	Gas piping
B	Liquid piping
C	Drain piping
D1	Power supply connection
D2	Remote control code and signal wiring connection
F	Suspension bolts
G	Outside air opening for ducting
H	Air outlet opening for ducting
J	Inspection opening

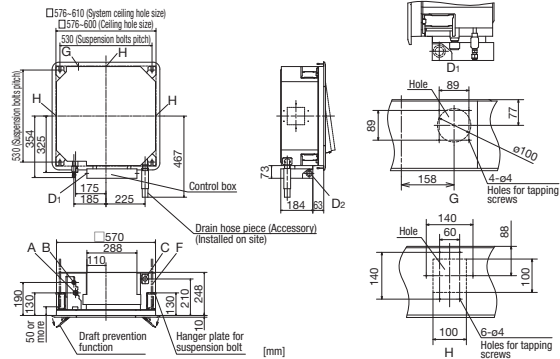
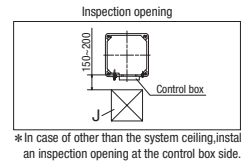

④ Installation of indoor unit

Work procedure

- This unit is designed to install on a system ceiling. If necessary, remove T bars temporarily before installing the unit. When it is installed on a ceiling other than the system ceiling, install an inspection port at the control box side.
- Determine the position of suspension bolts (530 mm × 530 mm).
- Use 4 suspension bolts, and fix them.
- Set the suspension bolt length to about 50 mm from the ceiling.
- Temporarily locate the lower nuts of the suspension bolts (4 places) at a position approximately 130 mm from the ceiling.
- Temporarily locate the upper nuts of the suspension bolts (4 places) at positions sufficiently distance from the lower nuts so that they do not interfere with the suspension of the indoor unit and with its height adjustment.
- Set the upper nuts of the suspension bolts and upper washers (4 places) at positions sufficiently distance from the lower nuts. Then, push and insert the temporary fixing carton of washers (*1) onto suspension bolts. Make sure that the upper washers do not slide down.
- Suspend the indoor unit.
- After suspending the indoor unit, mount the level gauge (*2) to the air outlet of the indoor unit, and adjust the suspension height of the indoor unit. Loosen the upper nuts (4 places), and adjust the suspension height using the lower nuts (4 places). Confirm there is no slack between the lower nuts and flat washers of the indoor unit hanger plate (4 places).
- Remove the temporary fixing carton of washers (from all 4 places).
- Make sure that the indoor unit is installed horizontally. Confirm the levelness of the indoor unit using a level gauge or transparent hose filled with water. (Keep the height difference at both ends of the indoor unit within 3 mm.)
- Tighten the upper nuts of the suspension bolts (4 places).

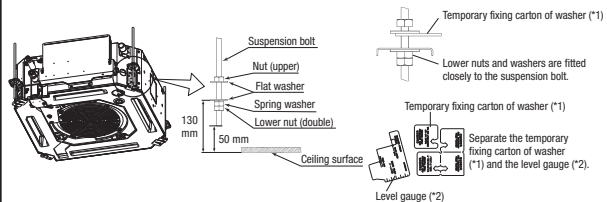

<In case of other than the system ceiling>

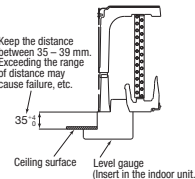

<In case of the system ceiling>

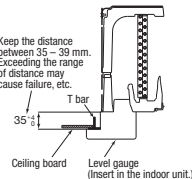

④ Installation of indoor unit (continued)

Protection of the indoor unit

- If it is not possible to install the panel for a while or if attaching the ceiling board after installing the indoor unit, protect the indoor unit by using upper carton.

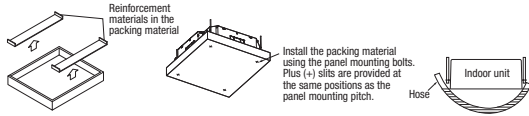

Caution

- Do not adjust the unit height by adjusting the upper nuts. Doing so will cause unexpected stress on the indoor unit and cause the unit to become deformed, prevent the gap from being installed, and be generated fan interference noise.
- Make sure that the indoor unit is installed horizontally and set the appropriate gap between the underside of the unit and the ceiling plane. Improper installation may cause air leakage, dew condensation, water leakage and noise.
- Make sure there is no gap between the panel and the ceiling surface, and between the panel and the indoor unit. Any gap may cause air and/or water to leak, or condensation to form.

⑤ Refrigerant pipe

Caution

- Be sure to use new pipes for the refrigerant pipes. Use the flare nut attached to the product. Regarding whether existing pipes can be reused or not, and the washing method, refer to the instruction manual of the outdoor unit, catalogue or technical data.
 - 1) In case of reuse: Do not use old flare nut, but use the nut attached to the unit.
 - 2) In case of reuse: Flare the end of pipe replaced partially for R32 or R410A.

⚠ WARNING : When flared joints are reused indoors, the flare part shall be re-fabricated. (only for R32)

Pipe dia. d mm	Min. pipe wall thickness mm	Protruding dimension for flare, mm		Flare O.D. D mm	Flare nut tightening torque N·m
		Rigid (Clutch type) For R32 For R410A	Conventional tool		
6.35	0.8	0 ~ 0.5	0.7 ~ 1.3	8.9 ~ 9.1	14 ~ 18
9.52	0.8			12.8 ~ 13.2	34 ~ 42
12.7	0.8			16.2 ~ 16.6	49 ~ 61
15.88	1			19.3 ~ 19.7	68 ~ 82
19.05	1.2			23.6 ~ 24.0	100 ~ 120

- Use phosphorus deoxidized copper alloy seamless pipe (C1220T) for refrigeration pipe installation. In addition, make sure there is no damage both inside and outside of the pipe, and no harmful substances such as sulfur, oxide, dust or a contaminant stuck on the pipes.
- Do not use any refrigerant other than the designated refrigerant. Using other refrigerant except the designated refrigerant, may degrade inside refrigeration oil. And air getting into refrigeration circuit may cause over-pressure and resultant it may result in bursting, etc.
- Store the copper pipes indoors and seal the both end of them until they are brazed in order to avoid any dust, dirt or water getting into pipe. Otherwise it will cause degradation of refrigeration oil and compressor breakdown, etc.
- Use special tools for R32 or R410A refrigerant.

Work procedure

1. Remove the flare nut and blind flanges on the pipe of the indoor unit.
 - * Make sure to loosen the flare nut with holding the nut on pipe side with a spanner and giving torque to the nut with another spanner in order to avoid unexpected stress to the copper pipe, and then remove them. (Gas may come out at this time, but it is not abnormal.)
 - Pay attention whether the flare nut pops out. (as the indoor unit is sometimes pressurized.)
2. Make a flare on liquid pipe and gas pipe, and connect the refrigeration pipes on the indoor unit.
 - * Bend radius of pipe must be 4D or larger. Once a pipe is bent, do not readjust the bending. Do not twist a pipe or collapse to 2/3D or smaller.
 - Make sure to use flare nuts assembled on the unions. Usage of other flare nuts could cause refrigerant leakage.
 - * Do a flare connection as follows:
 - Make sure to hold the nut on indoor unit pipe side using double spanner method as indicated when fastening / loosening flare nuts in order to prevent unintentional twisting of the copper pipe.
 - When fastening the flare nut, align the refrigeration pipe with the center of flare nut, screw the nut for 3-4 times by hand and then tighten it by spanner with the specified torque mentioned in the table above.
3. Cover the flare connection part of the indoor unit with attached insulation material after a gas leakage inspection, and tighten both ends with attached straps.
 - Make sure to insulate both gas pipes and liquid pipes completely.
 - * Incomplete insulation may cause dew condensation or water drooping.
 - Use heat-resistant (120 °C or more) insulations on the gas side pipes.
 - In case of using at high humidity condition, reinforce insulation of refrigerant pipes. Surface of insulation may cause dew condition or water drooping, if insulations are not reinforced.
4. Refrigerant is charged in the outdoor unit. As for the additional refrigerant charge for the indoor unit and piping, refer to the installation manual attached to the outdoor unit.

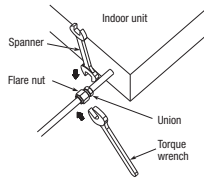

⑤ Refrigerant pipe (continued)

Caution:

Refrigerating machine oil should not be applied to the threads of union or external surface of flare. It is because, even if the same tightening torque is applied, the oil is likely to decrease the slide friction force on the threads and increase, in turn, the axial component force so that it could crack the flare by the stress corrosion. Refrigerating machine oil may be applied to the internal surface of flare only.

<The case of using thickness of insulation is 10mm>

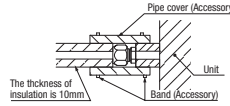

<The case of using reinforced insulation>

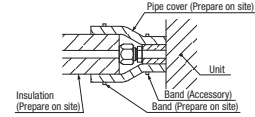

⑥ Drain pipe

Caution

- Install the drain pipe according to the installation manual in order to drain properly. Water may drip in the room, damaging user's belongings, unless it is worked as instructed.
- Be sure to use the supplied drain hose. Unless it is used, the drain socket could be damaged by undue stresses, causing water leakage.
- Do not put the drain pipe directly into the ditch where toxic gas such as sulfur, the other harmful and inflammable gas is generated. Toxic gas would flow into the room and it would cause serious damage to user's health and safety (some poisoning or deficiency of oxygen). In addition, it may cause corrosion of heat exchanger and bad smell.
- Connect the pipe securely to avoid water leakage from the joint.
- Insulate the pipe properly to avoid condensation drop.
- Check if the water can flow out properly from both the drain outlet on the indoor unit and the end of the drain pipe after installation.
- Make sure to make descending slope of greater than 1/100 and do not make up-down bend and/or trap in the midway. In addition, do not put air vent on the drain pipe. Check if water is drained out properly from the pipe during commissioning. Also, keep sufficient space for inspection and maintenance.

Drain socket and drain hose connection

- Where temperatures around the drain socket may rise beyond 50 °C, adhere the drain socket and the drain hose.
- Avoid using the hose clamp with adhesive. It could cause water leakage.

- <When using the hose clamp>
1. Make sure that the drain hose (the soft PVC side) is inserted into the end of the step part of the drain socket. Fix the hose clamp so that its bolt is located on the outside of the indoor unit, and the bolt are fastened in a vertical orientation.
 2. Position the hose clamp so that it touches the insulation of the drain hose, and then tighten the bolt.
 3. Turn the bolt several times until it is securely tightened, but do not tighten it excessively. Target extent of bolt tightening should be 17 to 20 mm (Reference: 1.2 to 1.5N·m)

<When using adhesives>

1. Connect the drain hose (the soft PVC side) to the drain socket using polyvinyl type adhesives. Make sure that the drain hose (the soft PVC side) is inserted into the end of the step part of the drain socket.
2. Use the adhesive according to maker's instructions.
 - * **Do not use adhesives containing phthalic esters. It could cause water leak.**
 - Make sure that the adhesive will not get into the drain hose or drain socket.

Drain hose and piping connection

1. Prepare a joint for connecting VP-25 pipe, adhere and connect the joint to the drain hose (the rigid PVC side), and adhere and connect VP-25 pipe (prepare on site).
 - * As for drain pipe, apply VP-25 made of rigid PVC which is on the market.
 - **Make sure that the adhesive will not get into the supplied drain hose.** It may cause the flexible part broken after the adhesive is dried up and gets rigid.
 - The flexible drain hose is intended to absorb a small difference at installation of the unit or drain pipes. Intentional bending, expanding may cause the flexible hose broken and water leakage.
2. Pay attention not to apply stresses to the drain socket or drain pipe, and support and fix the drain pipe as close place to the unit as possible when connecting the drain pipe. (within 250 mm from the end of joint prepared at site)
 - As for drain pipe, apply VP25 (OD32). If apply PVC25 (OD25), connect the expanded connector to the drain hose, with adhesive. (Multi unit only)
3. Make sure to make descending slope of greater than 1/100 and do not make up-down bend and/or trap in the midway.
 - Pay attention not to give stress on the pipe on the indoor unit side, and support and fix the pipe as close place to the unit as possible when connecting the drain pipe.
 - Do not set up air vent.

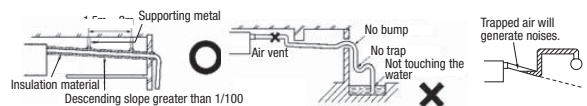

⑥ Drain pipe (continued)

- When sharing a drain pipe for more than 1 unit, lay the main pipe 100mm below the drain outlet of the unit. In addition, select VP30 or bigger size for main drain pipe.

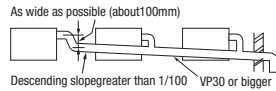

6. Insulate the drain pipe.

- Be sure to insulate the drain socket and rigid PVC pipe installed indoors otherwise it may cause dew condensation and water leakage.
- ※ After drainage test implementation, cover the drain socket part with pipe cover (small size), then use the pipe cover (big size) to cover the pipe cover (small size), clamps and part of the drain hose, and fix and wrap it with tapes to wrap and make joint part gapless.

Drain up

- The position for drain pipe outlet can be raised up to 850mm above the ceiling. Use elbows for installation to avoid obstacles inside ceiling. If the horizontal drain pipe is too long before vertical pipe, the backflow of water will increase when the unit is stopped, and it may cause overflow of water from the drain pan on the indoor unit. In order to avoid overflow, keep the horizontal pipe length and offset of the pipe within the limit shown in the figure below.

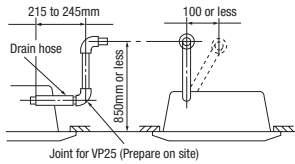

Drain test

- After installing the drain pipe, make sure that drain system works correctly and that no water leaks from the joint and drain pan. Check whether the motor sound of the drain pump is normal.
 - Conduct a drain test when installing, even during the heating season.
 - In the case of new buildings, be sure to complete the test before fixing the ceiling.
1. Pour about 1,000 cc of test water into the drain pan of the indoor unit. Exercise care not to allow electrical equipment such as the drain pump and other components to become wet while filling water. Pour test water through the pipe lid using a feed water pump or a similar device, or through the refrigerant pipe joint.

- In case of pouring water from the air outlet

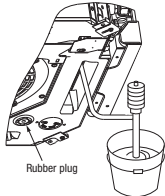

- In case of pouring water from the pipe lid
- (1) Remove screws at 2 places.
 - (2) Release the claws, and remove the lid.

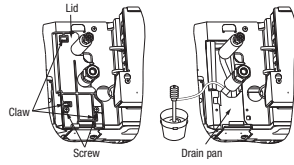

2. Make sure that water drains out completely and that no water leaks from any joints of the drain pipe during the test. Test to confirm that the water drains out correctly while listening to the drain pump motor operating sound. At the drain socket (transparent), it is possible to check whether the water drains out correctly.
3. Unplug the rubber plug on the indoor unit so that the remaining water drains from the drain pan after the draining test. After checking the water drainage, fix the rubber plug correctly. Installation work for the drain pipe must be performed for the entire drain pipe up to the indoor unit. If the pipe lid has been removed in order to pour water, mount the pipe lid again.

Drain pump operation

- In case electrical wiring work completed
Drain pump can be operated by the wired remote control. For the operation method, refer to [Operation for drain pump] in the installation manual for wiring work.
- In case electrical wiring work not completed
Drain pump will run continuously when the dip switch "SW7-1" on the indoor unit PCB is turned ON, the connector CnB is disconnected, and then the power source (230VAC on the terminal block ① and ②) is turned ON. Make sure to turn OFF "SW7-1" and reconnect the connector CnB after the test.

⑦ Wiring-out position and wiring connection

- Electrical installation work must be performed according to the installation manual by an electrical installation service provider qualified by a power provider of the country, and be executed according to the technical standards and other regulations applicable to electrical installation in the country.
 - Be sure to use an exclusive circuit.
 - Use specified cord, fasten the wiring to the terminal securely, and hold the cord securely in order not to apply unexpected stress on the terminal.
 - Do not put both power source line and signal line on the same route. It may cause miscommunication and malfunction.
 - Be sure to do D type earth work.
 - For the details of electrical wiring work, see attached instruction manual for electrical wiring work.
1. Loosen screws (2 pcs.) on the control box of the unit.
 2. Remove the control lid by sliding it in the arrow direction in the figure.
 3. Introduce the wiring in the control box, and connect it securely to the terminal block.
 4. Fix the wiring with bands as shown below.
 5. Install the control lid, with care not to pinch the wiring, and fix the lid with screws (2 pcs.).

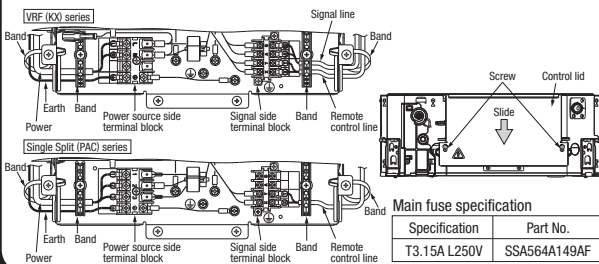

⑧ Panel installation

- Install the panel on the indoor unit after electrical wiring work.
- Refer to the attached manual for panel installation for details.

⑨ Check list after installation

- Check the following items after all installation work completed.

Check if;	Expected trouble	Check
The indoor and outdoor units are fixed securely?	Falling, vibration, noise	
Inspection for leakage is done?	Insufficient capacity	
Insulation work is properly done?	Water leakage	
Water is drained properly?	Water leakage	
Power source voltage is same as mentioned in the model name plate?	PCB burnt out, not working at all	
There is mis-wiring or mis-connection of piping?	PCB burnt out, not working at all	
Earth wiring is connected properly?	Electric shock	
Cable size comply with specified size?	PCB burnt out, not working at all	
Any obstacle blocks airflow on air inlet and outlet?	Insufficient capacity	

⑩ How to check the dirt of drain pan and cleaning the inlet of the drain pump. (Maintenance)

The method of checking the dirt of drain pan

1. Remove the panel according to the installation manual of the panel.
2. Check the dirt on the drain pan from the drain cap, and check the drain pump inlet. If the drain pan is very dirty, remove the drain pan and clean it.

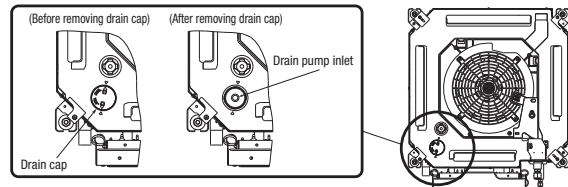

Cleaning of drain pump inlet

- It is possible to clean the drain pump inlet and surrounding area by removing the drain cap only; it is not necessary to remove the drain pan.
 - Before removing the drain cap, remove the rubber plug and drain water from the drain pan.
1. Insert the nose of the pliers into the concave portions (2 places) of the drain cap, and rotate the pliers about 1 turn in the CCW direction. The drain cap is removed.
 2. When cleaning the drain pump inlet, use a soft plastic tool. If a metallic tool is used, the drain cap mounting portion may be scratched and water may leak.
 3. Before mounting the drain cap, rinse it and **remove any foreign material from the inside of the cap**. If the drain cap is installed with foreign material inside it, it may cause water to leak.
 4. Insert the nose of the pliers into the concave portions of the drain cap and rotate the pliers to install the drain cap. Rotate the drain cap about 1 turn in the CW direction until it stops rotating. If the drain cap is not rotated for 1 or more turns, the cap will not have been installed correctly. Remove the drain cap, and then install it again correctly.
 5. After tightening the drain cap, make sure the triangle (▲) mark of the drain cap comes close to the triangle mark on the drain pan. If these triangle marks are not close to each other, tighten the drain cap further.
 6. Refix the rubber plug securely. If the cover is not refixed correctly, it may cause condensation to form and/or water to leak.

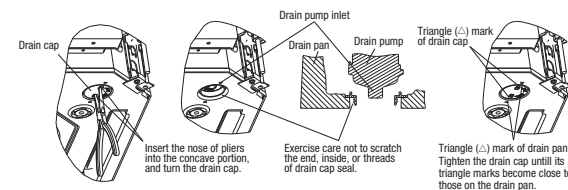

Notes for removing the drain pan

- Before removing the drain pan, drain water from the drain pan. Remove the rubber plug and drain water.
- The drain pan is installed by the temporary installation plate. Remove the 2 drain pan fixing screws, and loosen the 2 screws of the temporary installation plate. Slide the temporary installation plate to the outside of the drain pan. And then, it is possible to remove the drain pan.
- When reinstalling the drain pan, slide the temporary installation plate to the inside and temporarily fix the drain pan. Then, tighten the 2 drain pan fixing screws and the 2 screws of the temporary installation plate. Also, refix the rubber plug securely.

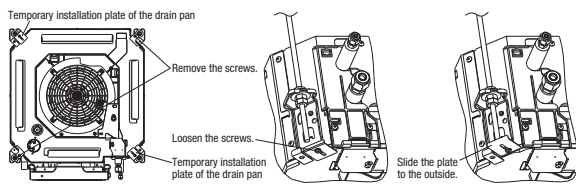

• Panel installation



Read this manual together with the indoor unit's installation manual.

* Caution before use

- ① Be careful the installation height when installing the indoor unit. Also note that the installation height of this indoor unit is different from that of current (old) unit.
Installation height from the ceiling surface to the indoor unit.
• Old unit: 30 mm → This unit: 35 mm

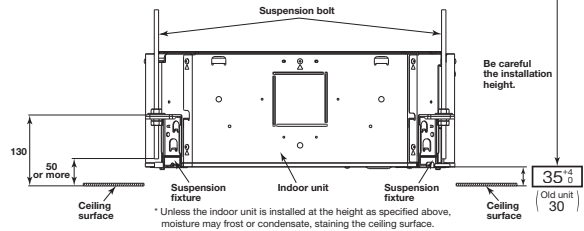

- ② Do not attempt to move forcibly the louver and the air flex.

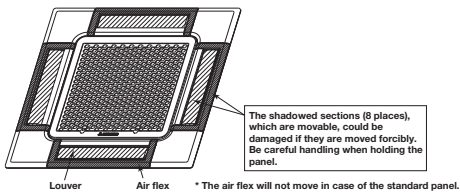

⚠ WARNING

- Fasten the wiring to the terminal securely and hold the cable securely so as not to apply unexpected stress on the terminal. Loose connection or hold will cause abnormal heat generation or fire.
- Make sure the power source is turned off when electric wiring work. Otherwise, electric shock, malfunction and improper running may occur.

Function

The draft prevention panel has the draft prevention mechanism. If the draft prevention panel is installed and the draft prevention function is set, the draft prevention function will be operated and reduce the draft feeling. (Refer to ⑩ Panel setting for details.)

- Standard panel : without the draft prevention mechanism
- Draft prevention panel : with the draft prevention mechanism

① Before installation

- Follow installation manual carefully, and install the panel properly.
- Check the following items.
- Accessories

Accessories		
Bolt	4 pieces	For panel installation
Strap	4 pieces	For avoiding the corner panel from falling
Grille hook	1 piece	For avoiding the grille from falling
Screw	4 pieces	For fixing the corner panel

Note: Accessories are laid in the position removing the corner lid.

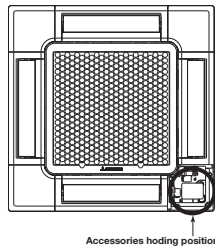

② Checking the indoor unit installation height

- Read this manual together with the air-conditioner installation manual carefully.
- Check if the opening size for the indoor unit is correct with the level gauge supplied in the indoor unit.
- Check if the gap between the plane and the indoor unit is correct by inserting the level gauge into the air outlet port of the indoor unit. (See below drawing)
- Adjust the installation elevation if necessary.
- Remove the level gauge before installing the panel.

Caution
If there is a height difference beyond the design limit between the installation level of the indoor unit and the panel, the panel may be subject to excessive stress during installation and it may cause distortion and damage.

<In case of other than the system ceiling>

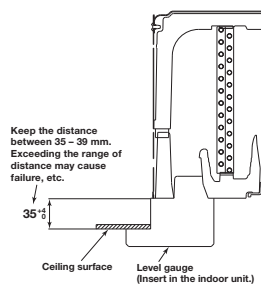

<In case of the system ceiling>

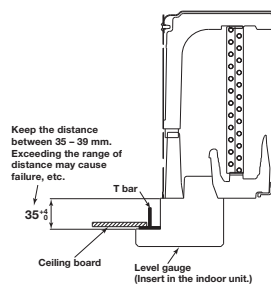

③ Removing the inlet grille

1. While placing a finger behind the stopper (2 places) and pressing it in the direction of arrow ①, pull the grille downward to open the grille.
2. Release the hooks of the inlet grille from the panel while it is in the open position.

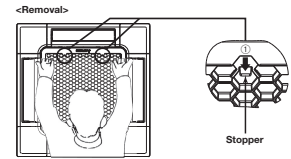

④ Removing the corner lid

- Pull the corner lid toward the direction indicated by the arrow and remove it. (Same way for all 4 corner lids)

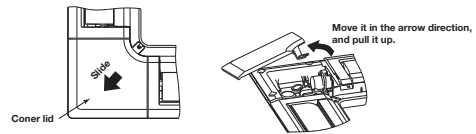

⑤ Before installing the panel <Only Draft prevention panel>

- ① Loosen screws (2 pcs.) on the control lid of the unit.
- ② Slide the control lid in the arrow direction in the figure, and remove it.
- ③ Loosen screws on the wiring cover (2 places).
- ④ Slide the wiring cover (2 places) in the arrow direction in the figure, and remove it.
- ⑤ Disconnect the relay connector of the air flex motor wiring attached to the panel.
- ⑥ Connect the air flex motor wiring to CNJ2 (20 P, gray) on PCB in the control box of the unit.
- ⑦ Pass the air flex motor wiring as shown in the figure.
- ⑧ Install the wiring cover (1 place) with care not to pinch wiring, and fix it with a screw.
- ⑨ Fix the air flex motor wiring with a band as shown in the figure.
- ⑩ Install the control lid with care not to pinch wiring, and fix with screws (2 places).

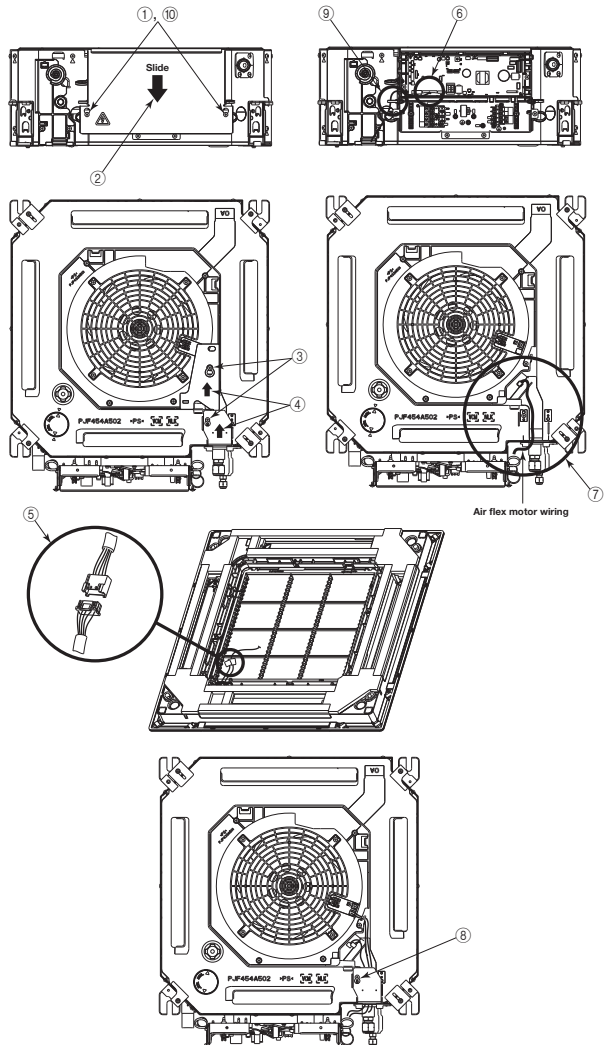

⑥ Orientation of the panel installation

- Take note that there is an orientation to install the panel.
- Install the panel with the orientation shown on the right.
 - Align the "PIPE SIDE" mark (on the panel) with the refrigerant pipes on the indoor unit.
 - Align the "DRAIN" mark (on the panel) with the drain pipe on the indoor unit.

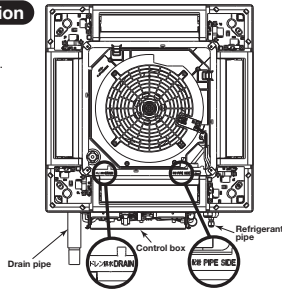

CAUTION

In case the orientation of the panel is not correct, it will lead to air leakage and also it is not possible to connect the motor wiring.

⑦ Installing the panel

1. Temporary hanging

- Lift up the hanger (2 places) on the panel for temporary support.
- Hang the panel on the hook on the indoor unit.

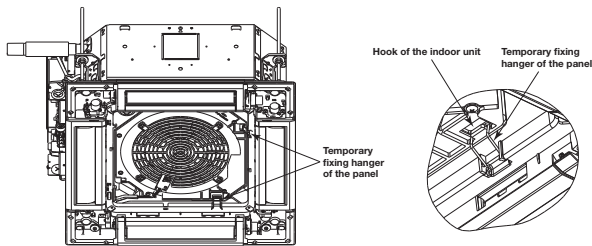

2. Fix the panel on the indoor unit

- Fasten the panel on the indoor unit with the 4 bolts supplied with the panel.

Caution

Be careful not to pinch the motion sensor wiring.

Caution

• Improperly tightened fixing bolts cause the problems listed below, so make sure that bolts are securely tightened.

• If there is a gap between the ceiling and the panel even after the fixing bolts are tightened, adjust the installation level of the indoor unit again.

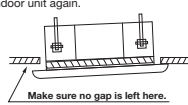
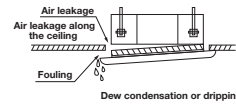

Bolt for installing the panel

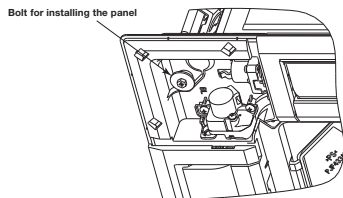

Caution

Do not give any stress on the panel when adjusting the height of the indoor unit to avoid unexpected distortion. It may cause the distortion of panel or failing to close the inlet grille, and the parts of the draft prevention mechanism.

⑧ Electrical wiring

The wiring work varies depending on the panel type. Select the wiring work appropriate for the panel type.

<For the standard panel>

- ① Connect the connector of the lower motor wiring (Wiring color: Red, Black) at the panel side to the connector CnJ3 (20 P, White) of the lower motor wiring (Wiring color: Red, Black) at the unit side.

For the Standard panel

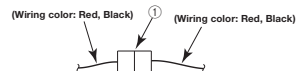
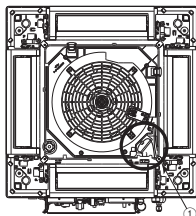

<For the draft prevention panel>

- ① Connect the connector of the lower motor wiring (Wiring color: Red, Black) at the panel side to the connector CnJ3 (20 P, White) of the lower motor wiring (Wiring color: Red, Black) at the unit side.
- ② Connect the connector of the air flex motor wiring (Wiring color: Blue, White) at the panel side to the connector CnJ4 (20 P, White) of the air flex motor wiring (Wiring color: Blue, White) at the unit side.

For the Draft prevention panel

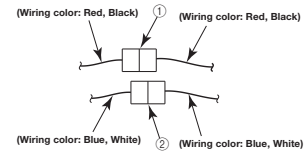
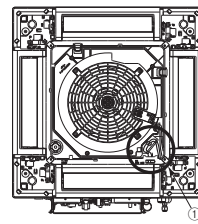

Motor wiring connection - Detail view

Install the wiring cover with care not to pinch wiring, and fix it with screws.

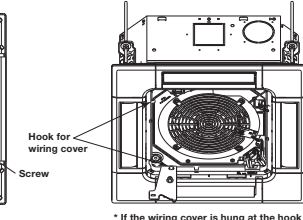
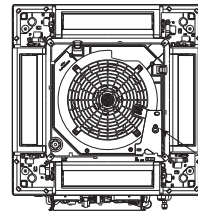

* If the wiring cover is hung at the hook on panel, it will become easier to work.

⑨ Installing a corner lid

1. To avoid unexpected falling of the corner lid, put the strap onto the corner lid's pin with turning the strap up.
2. Then hang the strap of a corner lid onto the panel's pin.
3. Hook the corner lid claws at 3 places, and fix the corner lid with attached screws.

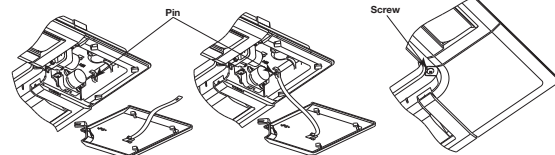

⑩ Installing the inlet grille

The panel and the inlet grille have no directional limitation to install. (Hinges of the inlet grille can be hooked at any side.)

Install the inlet grille in the reverse order of the steps described at **④ Removing the inlet grille**.

- ① Attach the fall grille hook to the panel.
- ② Insert the hinges of inlet grille in the insert holes on the panel.
- Close then the inlet grille while pressing the stoppers (2 places).
Confirm that both stoppers are inserted securely in the panel.

<① Installation of the grille hook>

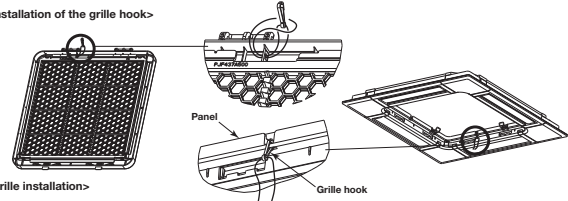

<② Grille installation>

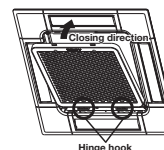

Caution

- Install the grille hook securely at the panel.
- The inlet grille must be installed starting from the hinge side.
- Install the inlet grille securely. It may drop if it is installed insecurely.
- When the stoppers have been deformed or damaged, repair them immediately. Unless they are repaired properly, the inlet grille may drop off.

⑪ Panel setting

<Louver swing range setting (Individual louver control setting)>

It is possible to change the swing range of the louver by the wired remote control. Once the upper and lower limit positions are set, the louver will swing within the set range. It is also possible to set the different range to each louver.

<Draft prevention setting>

The draft prevention function will not be operated if the draft prevention panel is installed and its wirings are only connected. To operate the draft prevention function, enable the draft prevention setting by using the wired or wireless remote control.

Note: It is not possible to set by the following remote control models or older.

- Wired: RC-EX3, RC-E5, RCH-E3
- Wireless: RCN-E1R

Once you have enabled the settings in this mode, the draft prevention function is operated when the air-conditioner is started, and the parts of the draft prevention mechanism are always open when the air-conditioner is operating. When the air-conditioner is stopped, they are closed. It is possible to enable or disabled the draft prevention function for each air outlet.

For the setting details, refer to the user's manual supplied with the remote control.

FRESH AIR INTAKE (Location for installation) FOR FDTC

At the time of installation use the duct hole (cut out) located at the positions shown in following diagram, as and when required.

(1) Temperature conditions for OA spacer ⁽¹⁾

- Adjust the temperature conditions of mixed air with outdoor air and indoor air within the usage range of suction air temperature for the air-conditioner.
- The usage temperature conditions of intake outdoor air and indoor air around the ducts are shown in the following table.
- If the temperature conditions of intake outdoor air do not meet, process the outdoor air before intaking.

Operation mode	Usage temperature conditions	
	Intake outdoor air	Indoor air around the ducts
Heating	5°C DB or higher	18.5°C WB or lower and 60% RH or lower
Cooling	29°C DB or lower and 80% RH or lower	20°C DB or higher

Note(1) : For the OA spacer, refer to page 303.

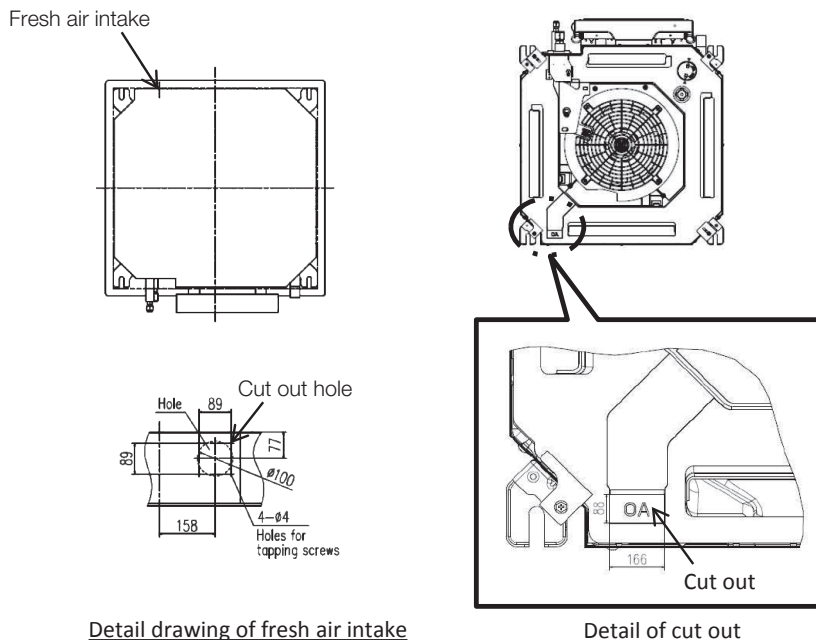

■ Fresh air intake amount & static pressure characteristics

All models

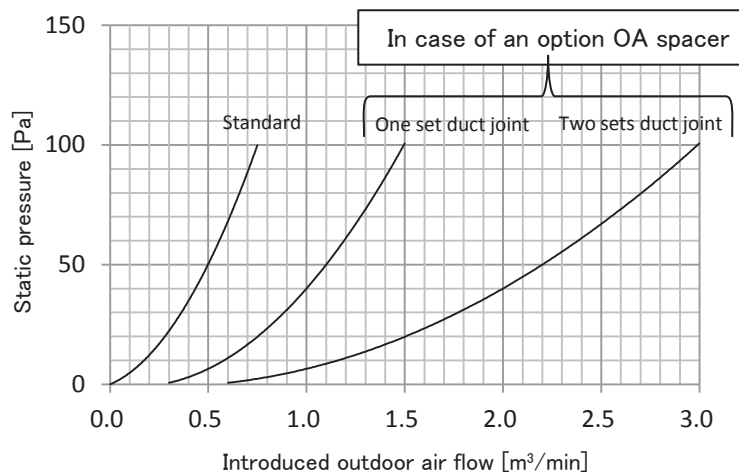

CHARACTERISTICS OF AIR FLOW IN DIVIDED DUCT FOR FDTC

Models FDTC25, 35VH1, 25, 35VH

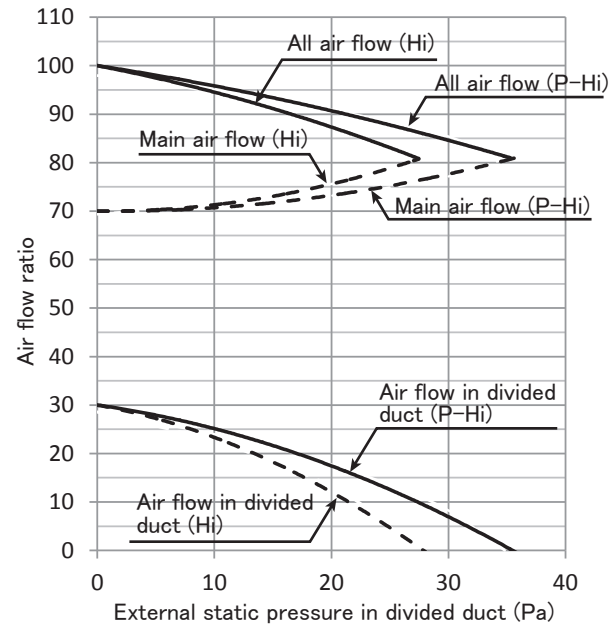
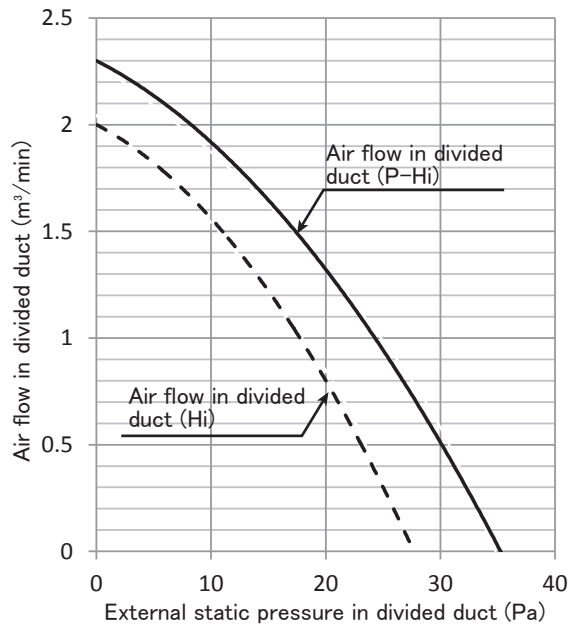

Models FDTC50, 60VH

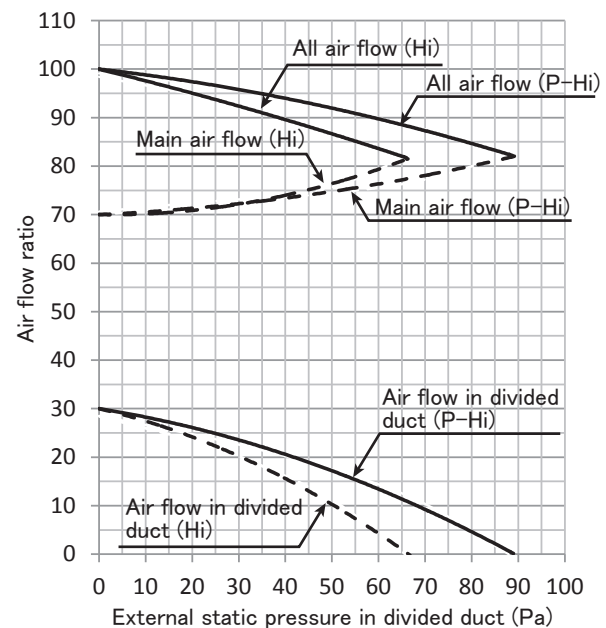
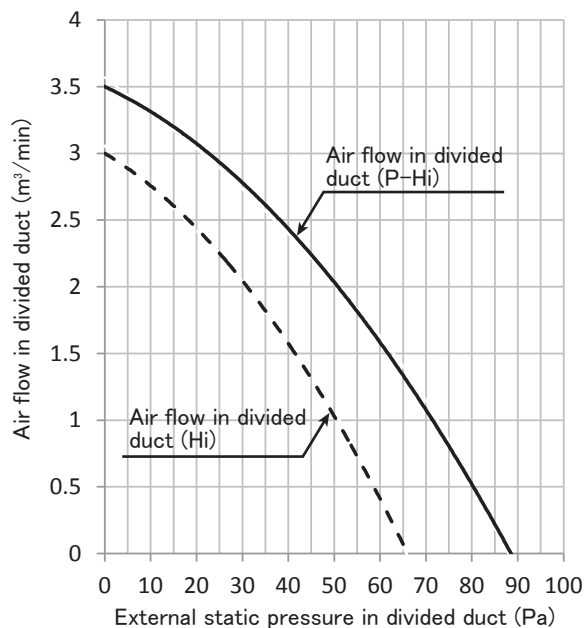

Divided duct connection method

1. Open some one during 4 knockout holes, and please connect a divided duct.

It isn't possible to use more than one hole at the same time.

2. Please make the wind shielding a blowout vent on the side where a divided duct was connected.

3. The storage of the external static pressure by pressure loss for a connected divided duct and blowout unit is made up by a booster fan.

example : When 2.5m³/min of ventilation by divided duct is needed in model FDTC60VH

(In case of connection duct ϕ 125 x 5m)

- ① Duct resistance : Pressure loss by a flexible duct = 35Pa (7Pa/mx5m)
- ② Blowout unit : Pressure loss by a blowout unit = 10Pa
- ③ External static pressure when being 2.5m³/min = 17Pa (See upper table.)

⇒ Correspondence by a booster fan = ① + ② + ③ = 28Pa

(5) Duct connected-Low/Middle static pressure type (FDUM)

PJG012D021

Models FDUM50VH

(a) Indoor unit

This manual is for the installation of an indoor unit.
 For electrical wiring work (Indoor), refer to page 211. For wired remote control installation, refer to page 227. For wireless kit installation, refer to page 255. For electrical wiring work (Outdoor) and refrigerant pipe work installation for outdoor unit, refer to page 9. For motion sensor kit installation, refer to page 279.

SAFETY PRECAUTIONS

- Read the "SAFETY PRECAUTIONS" carefully first of all and then strictly follow it during the installation work in order to protect yourself.
- The precautionary items mentioned below are distinguished into two levels: **WARNING** and **CAUTION**.
WARNING: Wrong installation would cause serious consequences such as injuries or death.
CAUTION: Wrong installation might cause serious consequences depending on circumstances.
 Both mentions the important items to protect your health and safety so strictly follow them by any means.
- The meanings of "Marks" used here are as shown on the right:
 Never do it under any circumstances. Always do it according to the instruction.
- After completing the installation, do commissioning to confirm there are no abnormalities, and explain to the customers about "SAFETY PRECAUTIONS", correct operation method and maintenance method (air filter cleaning, operation method and temperature setting method) with user's manual of this unit. Ask your customers to keep this installation manual together with the user's manual. Also, ask them to hand over the user's manual to the new user when the owner is changed.

WARNING

- **Installation should be performed by the specialist.**
 If you install the unit by yourself, it may lead to serious trouble such as water leakage, electric shock, fire, and injury due to overturn of the unit.
- **Install the system correctly according to these installation manuals.**
 Improper installation may cause explosion, injury, water leakage, electric shock, and fire.
- **Check the density referred by the formula (accordance with ISO5149).**
 If the density exceeds the limit density, please consult the dealer and installate the ventilation system.
- **Use the genuine accessories and the specified parts for installation.**
 If parts unspecified by our company are used it could cause water leakage, electric shock, fire, and injury due to overturn of the unit.
- **Ventilate the working area well in case the refrigerant leaks during installation.**
 If the refrigerant contacts the fire, toxic gas is produced.
 In case of R32, the refrigerant could be ignited because of its flammability.
- **Install the unit in a location that can hold heavy weight.**
 Improper installation may cause the unit to fall leading to accidents.
- **Install the unit properly in order to be able to withstand strong winds such as typhoons, and earthquakes.**
 Improper installation may cause the unit to fall leading to accidents.
- **Do not mix air in to the cooling cycle on installation or removal of the air-conditioner.**
 If air is mixed in, the pressure in the cooling cycle will rise abnormally and may cause explosion and injuries.
- **Be sure to have the electrical wiring work done by qualified electrical installer, and use exclusive circuit.**
 Power source with insufficient capacity and improper work can cause electric shock and fire.
- **Use specified wire for electrical wiring, fasten the wiring to the terminal securely, and hold the cable securely in order not to apply unexpected stress on the terminal.**
 Loose connections or hold could result in abnormal heat generation or fire.
- **Arrange the electrical wires in the control box properly to prevent them from rising. Fit the lid of the services panel properly.**
 Improper fitting may cause abnormal heat and fire.
- **Check for refrigerant gas leakage after installation is completed.**
 If the refrigerant gas leaks into the house and comes in contact with a fan heater, a stove, or an oven, toxic gas is produced.
- **Use the specified pipe, flare nut, and tools for R32 or R410A.**
 Using existing parts (R22) could cause the unit failure and serious accident due to explosion of the cooling cycle.
- **Tighten the flare nut according to the specified method by with torque wrench.**
 If the flare nut were tightened with excess torque, it could cause burst and refrigerant leakage after a long period.
- **Do not put the drainage pipe directly into drainage channels where poisonous gases such as sulfide gas can occur.**
 Poisonous gases will flow into the room through drainage pipe and seriously affect the user's health and safety. This can also cause the corrosion of the indoor unit and a resultant unit failure or refrigerant leak.
- **Connect the pipes for refrigeration circuit securely in installation work before compressor is operated.**
 If the compressor is operated when the service valve is open without connecting the pipe, it could cause explosion and injuries due to abnormal high pressure in the system.
- **Stop the compressor before removing the pipe after shutting the service valve on pump down work.**
 If the pipe is removed when the compressor is in operation with the service valve open, air would be mixed in the refrigeration circuit and it could cause explosion and injuries due to abnormal high pressure in the cooling cycle.
- **Only use prescribed option parts. The installation must be carried out by the qualified installer.**
 If you install the system by yourself, it can cause serious trouble such as water leaks, electric shocks, fire.
- **Do not repair by yourself. And consult with the dealer about repair.**
 Improper repair may cause water leakage, electric shock or fire.
- **Consult the dealer or a specialist about removal of the air-conditioner.**
 Improper installation may cause water leakage, electric shock or fire.
- **Turn off the power source during servicing or inspection work.**
 If the power is supplied during servicing or inspection work, it could cause electric shock and injury by the operating fan.
- **Do not run the unit when the panel or protection guard are taken off.**
 Touching the rotating equipment, hot surface, or high voltage section could cause an injury to be caught in the machine, to get burned, or electric shock.
- **Shut off the power before electrical wiring work.**
 It could cause electric shock, unit failure and improper running.

CAUTION

- **Perform earth wiring surely.**
 Do not connect the earth wiring to the gas pipe, water pipe, lightning rod and telephone earth wiring. Improper earth could cause unit failure and electric shock or fire due to a short circuit.
- **Earth leakage breaker must be installed.**
 If the earth leakage breaker is not installed, it could cause electric shocks or fire.
- **Use the circuit breaker of correct capacity. Circuit breaker should be the one that disconnect all poles under over current.**
 Using the incorrect one could cause the system failure and fire.
- **Do not use any materials other than a fuse of correct capacity where a fuse should be used.**
 Connecting the circuit by wire or copper wire could cause unit failure and fire.
- **Do not install the indoor unit near the location where there is possibility of flammable gas leakages.**
 If the gas leaks and gathers around the unit, it could cause fire.
- **Do not install and use the unit where corrosive gas (such as sulfurous acid gas etc.) or flammable gas (such as thinner, petroleum etc.) may be generated or accumulated, or volatile flammable substances are handled.**
 It could cause the corrosion of heat exchanger, breakage of plastic parts etc. And inflammable gas could cause fire.
- **Secure a space for installation, inspection and maintenance specified in the manual.**
 Insufficient space can result in accident such as personal injury due to falling from the installation place.
- **Do not use the indoor unit at the place where water splashes such as laundry.**
 Indoor unit is not waterproof. It could cause electric shock and fire.
- **Do not use the indoor unit for a special purpose such as food storage, cooling for precision instrument, preservation of animals, plants, and a work of art.**
 It could cause the damage of the items.
- **Do not install nor use the system near equipments which generate electromagnetic wave or high harmonics.**
 Equipments like inverter equipment, private power generator, high-frequency medical equipment, or telecommunication equipment might influence the air-conditioner and cause a malfunction and breakdown. Or the air-conditioner might influence medical equipments or telecommunication equipments, and obstruct their medical activity or cause jamming.
- **Do not install the remote control at the direct sunlight.**
 It could cause breakdown or deformation of the remote control.
- **Do not install the indoor unit at the place listed below.**
 - Places where flammable gas could leak.
 - Places where carbon fiber, metal powder or any powder is floated.
 - Place where the substances which affect the air-conditioner are generated such as sulfide gas, chlorine gas, acid, alkali or ammoniac atmospheres.
 - Places exposed to oil mist or steam directly.
 - On vehicles and ships
 - Places where machinery which generates high harmonics is used.
 - Places where cosmetics or special sprays are frequently used.
 - Highly salted area such as beach.
 - Heavy snow area
 - Places where the system is affected by smoke from a chimney.
 - Altitude over 1000m
- **Do not install the indoor unit in the locations listed below (Be sure to install the indoor unit according to the installation manual for each model because each indoor unit has each limitation)**
 - Locations with any obstacles which can prevent inlet and outlet air of the unit
 - Locations where vibration can be amplified due to insufficient strength of structure.
 - Locations where the infrared receiver is exposed to the direct sunlight or the strong light beam. (in case of the infrared specification unit)
 - Locations where an equipment affected by high harmonics is placed. (TV set or radio receiver is placed within 5m)
 - Locations where drainage cannot run off safely.
 - Do not install the motion sensor at following places. It could cause detection error, incapacity of detection, or characteristic degradation.
 - Place where vibration is applied to it for a long period of time.
 - Place where static electricity or electromagnetic wave generates.
 - Place where it is exposed to high temperature or humidity for a long period of time.
 - Dusty place or where the lens face could be fouled or damaged.
- **Do not put any valuables which will break down by getting wet under the air-conditioner.**
 Condensation could drop when the relative humidity is higher than 80% or drain pipe is clogged, and it damages user's belongings.
- **Do not use the base frame for the outdoor unit which is corroded or damaged after a long period of use.**
 It could cause the unit falling down and injury.
- **Pay attention not to damage the drain pan by weld sputter when brazing work is done near the unit.**
 If sputter entered into the unit during brazing work, it could cause damage (pinhole) of drain pan and leakage of water. To avoid damaging, keep the indoor unit packed or cover the indoor unit.
- **Install the drain pipe to drain the water surely according to the installation manual.**
 Improper connection of the drain pipe may cause dropping water into room and damaging user's belongings.
- **Do not share the drain pipe for indoor unit and GHP (Gas Heat Pump system) outdoor unit.**
 Toxic exhaust gas would flow into room and it might cause serious damage (some poisoning or deficiency of oxygen) to user's health and safety.
- **Be sure to perform air tightness test by pressurizing with nitrogen gas after completed refrigerant piping work.**
 If the density of refrigerant exceeds the limit in the event of refrigerant leakage in the small room, lack of oxygen can occur, which can cause serious accidents.
- **For drain pipe installation, be sure to make descending slope of greater than 1/100, not to make traps, and not to make air-bleeding.**
 Check if the drainage is correctly done during commissioning and ensure the space for inspection and maintenance.
- **Ensure the insulation on the pipes for refrigeration circuit so as not to condense water.**
 Incomplete insulation could cause condensation and it would wet ceiling, floor, and any other valuables.
- **Do not install the outdoor unit where is likely to be a nest for insects and small animals.**
 Insects and small animals could come into the electronic components and cause breakdown and fire. Instruct the user to keep the surroundings clean.
- **Pay extra attention, carrying the unit by hand.**
 Carry the unit with 2 people if it is heavier than 20kg. Do not use the plastic straps but the grabbing place, moving the unit by hand. Use protective gloves in order to avoid injury by the aluminum fin.
- **Make sure to dispose of the packaging material.**
 Leaving the materials may cause injury as metals like nail and woods are used in the package.
- **Do not operate the system without the air filter.**
 It may cause the breakdown of the system due to clogging of the heat exchanger.
- **Do not touch any button with wet hands.**
 It could cause electric shock.
- **Do not touch the refrigerant piping with bare hands when in operation.**
 The pipe during operation would become very hot or cold according to the operating condition, and it could cause a burn or frostbite.
- **Do not clean up the air-conditioner with water.**
 It could cause electric shock.
- **Do not turn off the power source immediately after stopping the operation.**
 Be sure to wait for more than 5 minutes. Otherwise it could cause water leakage or breakdown.
- **Do not control the operation with the circuit breaker.**
 It could cause fire or water leakage. In addition, the fan may start operation unexpectedly and it may cause injury.

○ This model is middle static ducted type air conditioning unit. Therefore, do not use this model for direct blow type air conditioning unit.

① Before installation

- Install correctly according to the installation manual.
- Confirm the following points:
 - Unit type/Power source specification
 - Pipes/Wires/Small parts
 - Accessory items

Accessory item

For hanging	For refrigerant pipe			For drain pipe			
Flat washer (M10)	Pipe cover (big)	Pipe cover (small)	Strap	Pipe cover (big)	Pipe cover (small)	Drain hose	Hose clamp
8	1	1	4	1	1	1	1
For unit hanging	For heat insulation of gas pipe	For heat insulation of liquid tube	For pipe cover fixing	For heat insulation of drain socket	For heat insulation of drain socket	For drain pipe connecting	For drain hose mounting

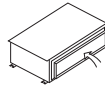

Accessory parts are stored inside this suction side.

② Selection of installation location for the indoor unit

- Select the suitable areas to install the unit under approval of the user.
 - Areas where the indoor unit can deliver hot and cold wind sufficiently. Suggest to the user to use a circulator if the ceiling height is over 3m to avoid warm air being accumulated on the ceiling.
 - Areas where there is enough space to install and service.
 - Areas where it can be drained properly. Areas where drain pipe descending slope can be taken.
 - Areas where there is no obstruction of air flow on both air return grille and air supply port.
 - Areas where fire alarm will not be accidentally activated by the air-conditioner.
 - Areas where the supply air does not short-circuit.
 - Areas where it is not influenced by draft air.
 - Areas not exposed to direct sunlight.
 - Areas where dew point is lower than around 28°C and relative humidity is lower than 80%.
 (This indoor unit is tested under the condition of JIS (Japan Industrial Standard) high humidity condition and confirmed there is no problem. However, there is some risk of condensation drop if the air-conditioner is operated under the severer condition than mentioned above. If there is a possibility to use it under such a condition, attach additional insulation of 10 to 20mm thick for entire surface of indoor unit, refrigeration pipe and drain pipe.)
 - Areas where TV and radio stays away more than 1m. (It could cause jamming and noise.)
 - Areas where any items which will be damaged by getting wet are not placed such as food, table wares, server, or medical equipment under the unit.
 - Areas where there is no influence by the heat which cookware generates.
 - Areas where not exposed to oil mist, powder and/or steam directly such as above fryer.
 - Areas where lighting device such as fluorescent light or incandescent light doesn't affect the operation.
 (A beam from lighting device sometimes affects the infrared receiver for the wireless remote control and the air conditioner might not work properly.)
- Check if the place where the air-conditioner is installed can hold the weight of the unit. If it is not able to hold, reinforce the structure with boards and beams strong enough to hold it. If the strength is not enough, it could cause injury due to unit falling.

Space for installation and service

- Make installation altitude over 2.5m.
(Indoor Unit)
- Select either of two cases to keep space for installation and services.

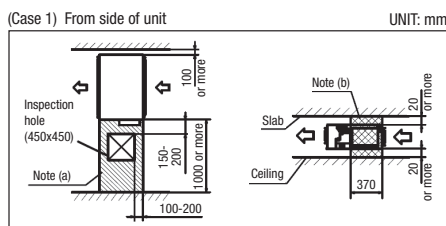

- Notes (a) There must not be obstacle to draw out fan motor. (▨ marked area)
 (b) Install refrigerant pipe, drain pipe, and wiring so as not to cross (▨ marked area).

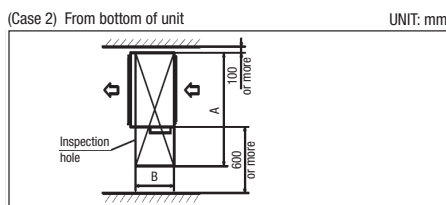

(Size of inspection hole)	UNIT: mm		
Single type	40-50	60, 71	100-140
Multi type	22-56	71, 90	112-160
A	1100	1300	1720
B	620	725	

③ Preparation before installation

- If suspension bolt becomes longer, do reinforcement of earthquake resistant.
 - For grid ceiling
 When the suspension bolt length is over 500mm, or the gap between the ceiling and roof is over 700mm, apply earthquake resistant brace to the bolt.
 - In case the unit is hung directly from the slab and is installed on the ceiling plane which has enough strength.
 When suspension bolt length is over 1000mm, apply the earthquake resistant brace to the bolt.
- Prepare four (4) sets of suspension bolt, nut and spring washer (M10) on site.

Suspension Bolt Location

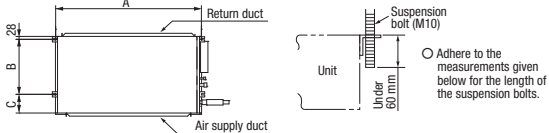

	UNIT: mm		
Multi type	22-56	71, 90	112-160
Single type	40-50	60, 71	100-140
A	786	986	1404
B	472	472	530
C	135	135	180

Pipe locations

	UNIT: mm
Multi type	22-90
Single type	40-71

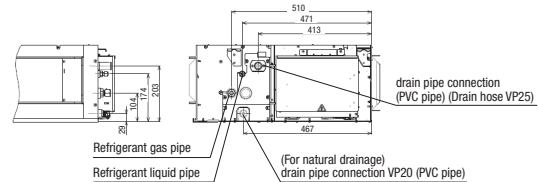

Multi type	112-160
Single type	100-140

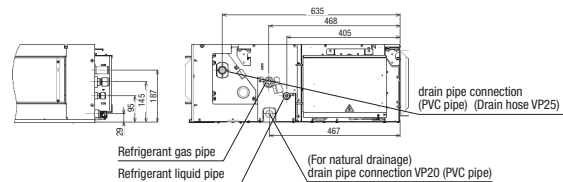

④ Installation of indoor unit

Installation

[Hanging]

Hang the unit up.

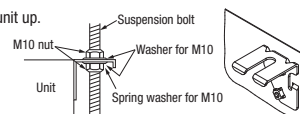

Adjustment for horizontality

○ Either use a level vial, or adjust the level according to the method below.

- Adjust so the bottom side of the unit will be leveled with the water surface as illustrated below.

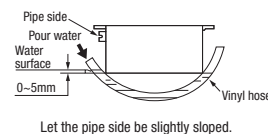

○ If the unit is not leveled, it may cause malfunctions or inoperation of the float switch.

⑤ Duct Work

① A corrugated board (for preventing sputtering) is attached to the main body of the air-conditioner (on the outlet port). Do not remove it until connecting the duct.

● An air filter can be provided on the main body of the air-conditioner (on the inlet port). Remove it when connecting the duct on the inlet port.

② Blowout duct

● Use rectangular duct to connect with unit.
Duct size for each unit is as shown below.

	UNIT: mm		
Single type	40-50	60, 71	100-140
Multi type	22-56	71, 90	112-140
A	682	882	1202
B	172	172	172

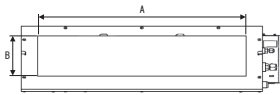

- Duct should be at their minimum length.
- We recommend to use sound and heat insulated duct to prevent it from condensation.
- Connect duct to unit before ceiling attachment.

③ Inlet port

- When shipped the inlet port lies on the back.
- When connecting the duct to the inlet port, remove the air filter if it is fitted to the inlet port.
- When placing the inlet port to carry out suction from the bottom side, use the following procedure to replace the suction duct joint and the bottom plate.

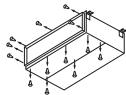

● Remove the screws which fasten the bottom plate and the duct joint on the inlet port side of the unit.

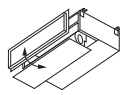

● Replace the removed bottom plate and duct joint.

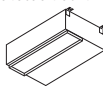

● Fit the duct joint with a screw; fit the bottom plate.

● Make sure to insulate the duct to prevent dewing on it.

④ Install the specific blowout duct in a location where the air will circulate to the entire room.

- Conduct the installation of the specific blowout hole and the connection of the duct before attaching them to the ceiling.
- Insulate the area where the duct is secured by a band for dew condensation prevention.

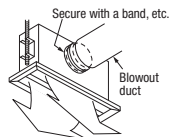

⑤ Make sure provide an inspection hole on the ceiling. It is indispensable to service electric equipment, motor, functional components and cleaning of heat exchanger.

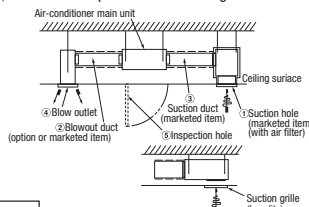

Bad example of duct work

① If a duct is not provided at the suction side but it is substituted with the space over the ceiling, humidity in the space will increase by the influence of capacity of ventilation fan, strength of wind blowing against the out door air louver, weather (rainy day) and others.

a) Moisture in air is likely to condense over the external plates of the unit and to drip on the ceiling. Unit should be operated under the conditions as listed in the above table and within the limitation of wind volume. When the building is a concrete structure, especially immediately after the construction, humidity tends to rise even if the space over the ceiling is not substituted in place of a duct. In such occasion, it is necessary to insulate the entire unit with glass wool (25mm). (Use a wire net or equivalent to hold the glass wool in place.)

b) It may run out the allowable limit of unit operation (Example: When outdoor air temperature is 35°C DB, suction air temperature is 27°C WB) and it could result in such troubles as compressor overload, etc..

c) There is a possibility that the blow air volume may exceed the allowable range of operation due to the capacity of ventilation fan or strength of wind blowing against external air louver so that drainage from be heat exchanger may fall to reach the drain pan but leak outside (Example: drip on to the ceiling) with consequential water leakage in the room.

② If vibration damping is not conducted between the unit and the duct, and between the unit and the slab, vibration will be transmitted to the duct and vibration noise may occur. Also, vibration may be transmitted from the unit to the slab. Vibration damping must be performed.

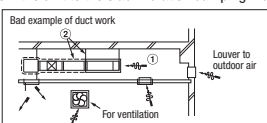

⑤ Duct Work (continued)

Connecting the air intake/vent ducts

① Fresh Air Intake
[for air intake duct only]
● Use the side fresh air intake hole, or supply through a part of the suction duct.

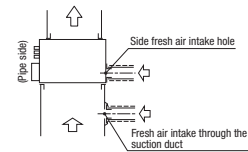

[for simultaneous air intake/vent]
● Intake air through the suction duct.
(the side cannot be used)

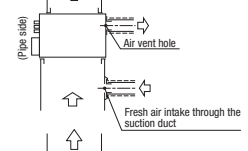

② Air Vent
● Use the side air vent hole.
(always use together with the air intake)

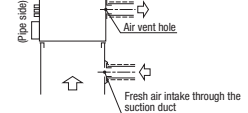

● Insulate the duct to protect it from dew condensation.

⑥ Refrigerant pipe

Caution

● Be sure to use new pipes for the refrigerant pipes. Use the flare nut attached to the product.

Regarding whether existing pipes can be reused or not, and the washing method, refer to the instruction manual of the outdoor unit, catalogue or technical data.

- 1) In case of reuse: Do not use old flare nut, but use the one attached to the unit.
- 2) In case of reuse: Flare the end of pipe replaced partially for R32 or R410A.

⚠WARNING: When flared joints are reused indoors, the flare part shall be re-fabricated. (only for R32)

Pipe diameter d mm	Min. pipe wall thickness mm	Protruding dimension for flare, mm		Flare O.D. D mm	Flare nut lightening torque N·m
		Rigid (Clutch type) For R32 For R410A	Conventional tool		
6.35	0.8	0 - 0.5	0.7 - 1.3	8.9 - 9.1	14 - 18
9.52	0.8			12.8 - 13.2	34 - 42
12.7	0.8			16.2 - 16.6	49 - 61
15.88	1			19.3 - 19.7	68 - 82
19.05	1.2			23.6 - 24.0	100 - 120

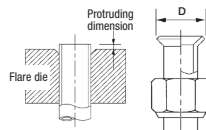

● Use phosphorus deoxidized copper alloy seamless pipe (C1220T) for refrigeration pipe installation. In addition, make sure there is no damage both inside and outside of the pipe, and no harmful substances such as sulfur, oxide, dust or a contaminant stuck on the pipes.

● Do not use any refrigerant other than R32 or R410A.

Using other refrigerant except R32 or R410A (R22 etc.) may degrade inside refrigeration oil. And air getting into refrigeration circuit may cause over-pressure and resultant it may result in bursting, etc.

● Store the copper pipes indoors and seal the both end of them until they are brazed in order to avoid any dust, dirt or water getting into pipe. Otherwise it will cause degradation of refrigeration oil and compressor breakdown, etc.

● Use special tools for R32 or R410A refrigerant.

Piping work

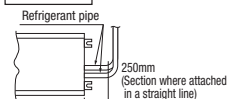

When conducting piping work, make sure to allow the pipes to be aligned in a straight line for at least 250 mm, as shown in the left illustration. (This is necessary for the drain pump to function)

Work procedure

1. Remove the flare nut and blind flanges on the pipe of the indoor unit.
 - ※ Make sure to loosen the flare nut with holding the nut on pipe side with a spanner and giving torque to the nut with another spanner in order to avoid unexpected stress to the copper pipe, and then remove them. (Gas may come out at this time, but it is not abnormal.)
 - Pay attention whether the flare nut pops out. (as the indoor unit is sometimes pressured.)
2. Make a flare on liquid pipe and gas pipe, and connect the refrigeration pipes on the indoor unit.
 - ※ Bend radius of pipe must be 4D or larger. Once a pipe is bent, do not readjust the bending. Do not twist a pipe or collapse to 2/3D or smaller.
 - Make sure to use flare nuts assembled on the unions. Usage of other flare nuts could cause refrigerant leakage.
 - ※ Do a flare connection as follows:
 - Make sure to hold the nut on indoor unit pipe side using double spanner method as indicated when fastening / loosening flare nuts in order to prevent unintentional twisting of the copper pipe.
 - When fastening the flare nut, align the refrigeration pipe with the center of flare nut, screw the nut for 3-4 times by hand and then tighten it by spanner with the specified torque mentioned in the table above.
3. Cover the flare connection part of the indoor unit with attached insulation material after a gas leakage inspection, and tighten both ends with attached straps.
 - Make sure to insulate both gas pipes and liquid pipes completely.
 - ※ Incomplete insulation may cause dew condensation or water dropping.
 - Use heat-resistant (120 °C or more) insulations on the gas side pipes.
 - In case of using at high humidity condition, reinforce insulation of refrigerant pipes. Surface of insulation may cause dew condition or water dropping, if insulations are not reinforced.

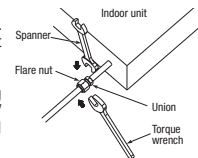

⑥ Refrigerant pipe (continued)

4. Refrigerant is charged in the outdoor unit. As for the additional refrigerant charge for the indoor unit and piping, refer to the installation manual attached to the outdoor unit.

Caution:
Refrigerating machine oil should not be applied to the threads of union or external surface of flare. It is because, even if the same tightening torque is applied, the oil is likely to decrease the slide friction force on the threads and increase, in turn, the axial component force so that it could crack the flare by the stress corrosion.
Refrigerating machine oil may be applied to the internal surface of flare only.

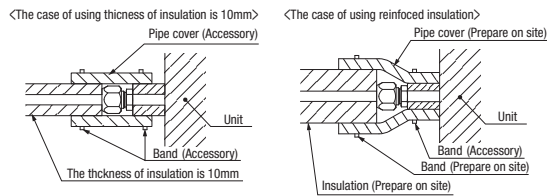

⑦ Drain pipe

Caution

- Install the drain pipe according to the installation manual in order to drain properly. Imperfection in draining may cause flood indoors and wetting the household goods, etc.
- Do not put the drain pipe directly into the ditch where toxic gas such as sulfur, the other harmful and inflammable gas is generated. Toxic gas would flow into the room and it would cause serious damage to user's health and safety (some poisoning or deficiency of oxygen). In addition, it may cause corrosion of heat exchanger and bad smell.
- Connect the pipe securely to avoid water leakage from the joint.
- Insulate the pipe properly to avoid condensation drop.
- Check if the water can flow out properly from both the drain outlet on the indoor unit and the end of the drain pipe after installation.
- Make sure to make descending slope of greater than 1/100 and do not make up-down bend and/or trap in the midway. In addition, do not put air vent on the drain pipe. Check if water is drained out properly from the pipe during commissioning. Also, keep sufficient space for inspection and maintenance.

Work procedure

1. Make sure to insert the drain hose (the end made of soft PVC) to the end of the step part of drain socket.
Attach the hose clamp to the drain hose around 10mm from the end, and fasten the screw about 5mm left to the nut.
● Do not apply adhesives on this end.
● Do not use acetone-based adhesives to connect to the drain socket.

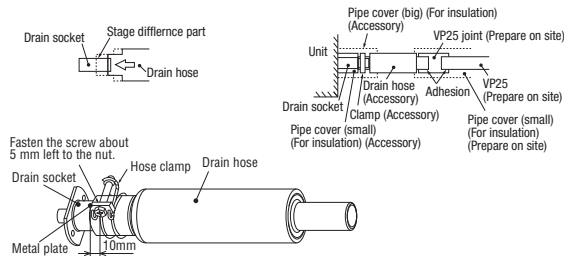

2. Prepare a joint for connecting VP25 pipe, adhere and connect the joint to the drain hose (the end made of rigid PVC), and adhere and connect VP25 pipe (prepare on site).
※As for drain pipe, apply VP25 made of rigid PVC which is on the market.
● Make sure that the adhesive will not get into the supplied drain hose.
It may cause the flexible part broken after the adhesive is dried up and gets rigid.
● The flexible drain hose is intended to absorb a small difference at installation of the unit or drain pipes. Intentional bending, expanding may cause the flexible hose broken and water leakage.

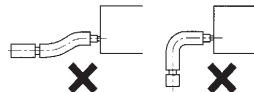

- As for drain pipe, apply VP25 (OD32).
If apply PVC25 (OD25), connect the expanded connector to the drain hose, with adhesive. (Multi unit only)

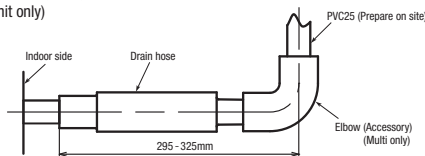

⑦ Drain pipe (continued)

3. Make sure to make descending slope of greater than 1/100 and do not make up-down bend and/or trap in the midway.
● Pay attention not to give stress on the pipe on the indoor unit side, and support and fix the pipe as close place to the unit as possible when connecting the drain pipe.
● Do not set up air vent.

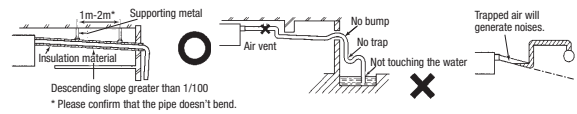

- When sharing a drain pipe for more than one unit, lay the main pipe 100mm below the drain outlet of the unit. In addition, select VP30 or bigger size for main drain pipe.

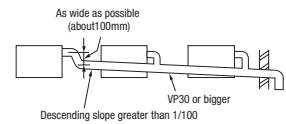

4. Insulate the drain pipe.
● Be sure to insulate the drain socket and rigid PVC pipe installed indoors otherwise it may cause dew condensation and water leakage.
※After drainage test implementation, cover the drain socket part with pipe cover (small size), then use the pipe cover (big size) to cover the pipe cover (small size), clamps and part of the drain hose, and fix and wrap it with tapes to wrap and make joint part gapless.

Drain up

- The position for drain pipe outlet can be raised up to 600mm above the ceiling. Use elbows for installation to avoid obstacles inside ceiling. If the horizontal drain pipe is too long before vertical pipe, the backflow of water will increase when the unit is stopped, and it may cause overflow of water from the drain pan on the indoor unit. In order to avoid overflow, keep the horizontal pipe length and offset of the pipe within the limit shown in the figure below.

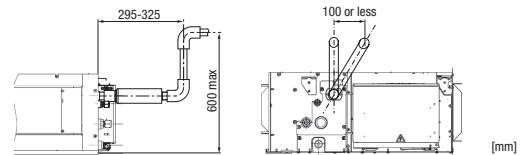

Otherwise, the construction point makes it same as drain pipe construction.

Drain test

1. Conduct a drain test after completion of the electrical work.
2. During the trial, make sure that drain flows properly through the piping and that no water leaks from connections.
3. In case of a new building, conduct the test before it is furnished with the ceiling.
4. Be sure to conduct this test even when the unit is installed in the heating season.

Procedures

1. Supply about 1000 cc of water to the unit through the air outlet by using a feed water pump.
2. Check the drain while cooling operation.

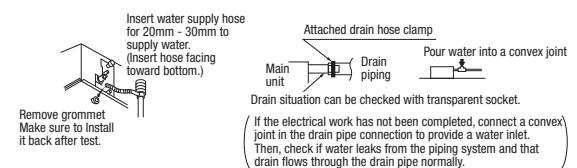

Outline of bottom drain piping work

- If the bottom drain piping can be done with a descending gradient (1/50-1/100), it is possible to connect the pipes as shown in the drawing below.

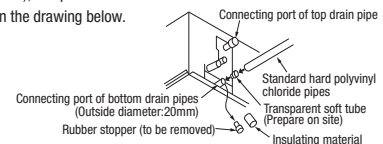

Uncoupling the drain motor connector

- Uncouple the connector CnR for the drain motor as illustrated in the drawing on the right.

(Note: If the unit is run with the connector coupled, drain water will be discharged from the upper drain pipe joint, causing a water leak.)

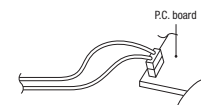

⑧ Wiring-out position and wiring connection

- Electrical installation work must be performed according to the installation manual by an electrical installation service provider qualified by a power provider of the country, and be executed according to the technical standards and other regulations applicable to electrical installation in the country.
Be sure to use an exclusive circuit.
 - Use specified cord, fasten the wiring to the terminal securely, and hold the cord securely in order not to apply unexpected stress on the terminal.
 - Do not put both power source line and signal line on the same route. It may cause miscommunication and malfunction.
 - Be sure to do D type earth work.
 - For the details of electrical wiring work, see attached instruction manual for electrical wiring work.
1. Remove a lid of the control box (2 screws).
 2. Hold each wiring inside the unit and fasten them to terminal block securely.
 3. Fix the wiring with clamps.
 4. Install the removed parts back to original place.

Single unit wiring connection

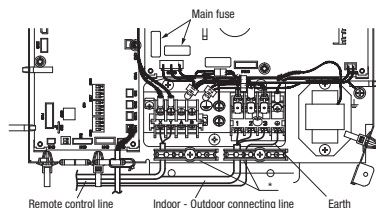

Multi unit wiring connection

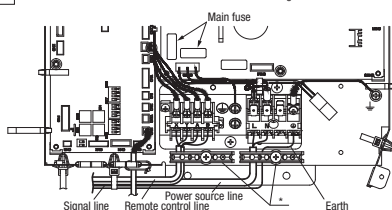

* Please fix the wiring in the band not to move even if it pulls.

Main fuse specification

Model	Specification	Part No.
22-56	T3.15A L250V	SSA564A149AF
71-160	T5A L250V	SSA564A149AH

⑨ External static pressure setting

You can set External Static Pressure (E.S.P.) by either method of MANUAL SETTING or AUTOMATIC SETTING by remote control.
Indoor unit will control fan-speed to keep rated air flow volume at each fan speed setting (Lo-Uhi)

1. MANUAL SETTING

You can set required E.S.P. by wired remote control that calculated with the set air flow rate and pressure loss of the duct connected.

Select No.1-10 (10Pa-100Pa) from following table according to calculation result.

Refer to technical manual for details of air flow characteristic.

Setting No.	1	2	3	4	5	6	7	8	9	10
External Static Pressure (Pa)	10	20	30	40	50	60	70	80	90	100

※ When you set No.11-19 by remote control, unit will control fan-speed with setting of No.10 Factory default is at No.5.

● How to set E.S.P. by wired remote control

- ① Push "◆" marked button(E.S.P. button).
 - ② Select indoor unit No. by using ◆ button.
 - ③ Select setting No. by using ◆ button and set E.S.P. by □ button.
- See detailed procedure in technical manual.

Notice

You can not set E.S.P. by wireless remote control.

E.S.P. button



Caution

Be sure to set E.S.P. according to actual duct connected.
Wrong settings causes excessive air flow volume or water drop blown out.

2. AUTOMATIC SETTING

Indoor unit will recognize E.S.P. by itself automatically and select appropriate fan speed No.1-10.

⑨ External static pressure setting (continued)

● How to start automatic setting

- ①, ② Same setting as MANUAL SETTING.
- ③ Select [AUT] by using ◆ button and press □ button.
- ④ After setting E.S.P. at "AUT", operate unit in FAN mode with certain fan speed (Lo-Uhi).

Indoor unit fan will run automatically and recognize E.S.P. by itself.

The operation for automatic E.S.P. recognition will last about 6 minutes, and it will be stopped after recognition is completed.

Caution

- Be sure to execute AUTOMATIC SETTING by remote control AFTER ducting work is completed.
- When duct specification is changed after AUTOMATIC SETTING, be sure to execute AUTOMATIC SETTING again after power resetting and turning on again.
- Be sure to execute AUTOMATIC SETTING before trial cooling operation.
- (See ELECTRICAL WIRING WORK INSTRUCTION about trial cooling operation)
- Before AUTOMATIC SETTING, be sure to check that return air filter in duct is installed and damper is opened.
- Wrong procedure causes excessive air flow or water drop blown out.

Notice

- During operation for automatic recognition (the Auto Operation), fan rotates with certain speeds regardless of set fan speed by remote control.
- When duct is set with low static pressure (around 10-50Pa), even if indoor unit operate with higher air flow volume than rated one, but it is not abnormal.
- When you changed operation mode or stop operation with ON/OFF button during Auto Operation, the Auto operation will be canceled.
- In such case, be sure to execute AUTOMATIC SETTING again according to above procedure.

⑩ Check list after installation

● Check the following items after all installation work completed.

Check if	Expected trouble	Check
The indoor and outdoor units are fixed securely?	Falling, vibration, noise	
Inspection for leakage is done?	Insufficient capacity	
Insulation work is properly done?	Water leakage	
Water is drained properly?	Water leakage	
Power source voltage is same as mentioned in the model name plate?	PCB burnt out, not working at all	
No mis-wiring or mis-connection of piping?	PCB burnt out, not working at all	
Earth wiring is connected properly?	Electric shock	
Cable size comply with specified size?	PCB burnt out, not working at all	
Any obstacle blocks air flow on air inlet and outlet?	Insufficient capacity	
Is setting of E.S.P. finished?	Excessive air flow, water drop blown out	

(b) Replacement procedure of the fan unit

- Notes(1) The unit is a heavy item. It must be supported securely and handled with care not to drop when it is necessary to replace.
(2) For the maintenance space, refer to page 202.

Model FDUM50VH

- 1) Remove the control box and the side panel, and remove the screws marked in the circles (2 places) in the figure.

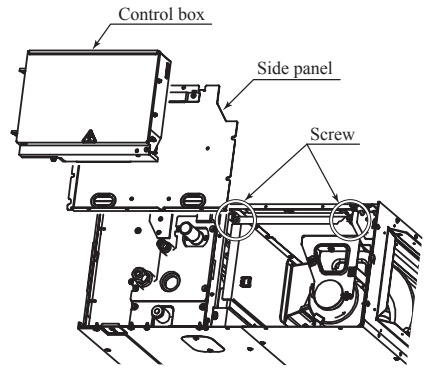

- 2) Take out the fan unit in the arrow direction.

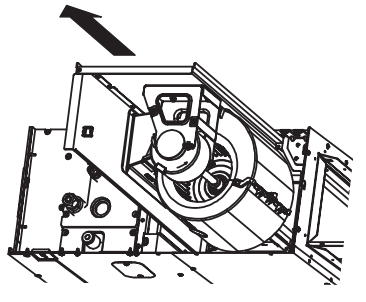

PFA012D636B

(6) Ceiling suspended type (FDE)

Model FDE50VH

This manual is for the installation of an indoor unit.
 For electrical wiring work (Indoor), refer to page 211. For wired remote control installation, refer to page 227. For wireless kit installation, refer to page 265. For electrical wiring work (Outdoor) and refrigerant pipe work installation for outdoor unit, refer to page 9. For motion sensor kit installation, refer to page 287.

SAFETY PRECAUTIONS

- Read the "SAFETY PRECAUTIONS" carefully first of all and then strictly follow it during the installation work in order to protect yourself.
- The precautionary items mentioned below are distinguished into two levels. **⚠️WARNING** and **⚠️CAUTION**.
⚠️WARNING: Wrong installation would cause serious consequences such as injuries or death.
⚠️CAUTION: Wrong installation might cause serious consequences depending on circumstances.
 Both mentions the important items to protect your health and safety so strictly follow them by any means.
- The meanings of "Marks" used here are as shown as follows:
 Never do it under any circumstances. Always do it according to the instruction.
- After completing the installation, do commissioning to confirm there are no abnormalities, and explain to the customers about "SAFETY PRECAUTIONS", correct operation method and maintenance method (air filter cleaning, operation method and temperature setting method) with user's manual of this unit. Ask your customers to keep this installation manual together with the user's manual. Also, ask them to hand over the user's manual to the new user when the owner is changed.

⚠️WARNING

- **Installation should be performed by the specialist.**
 If you install the unit by yourself, it may lead to serious trouble such as water leakage, electric shock, fire, and injury due to overturn of the unit.
- **Install the system correctly according to these installation manuals.**
 Improper installation may cause explosion, injury, water leakage, electric shock, and fire.
- **When installing in small rooms, take prevention measures not to exceed the density limit of refrigerant in the event of leakage, referred by the formula (accordance with ISO5149).**
 If the density of refrigerant exceeds the limit, please consult the dealer and install the ventilation system, otherwise lack of oxygen can occur, which can cause serious accidents.
- **Use the genuine accessories and the specified parts for installation.**
 If parts unspecified by our company are used it could cause water leakage, electric shock, fire, and injury due to overturn of the unit.
- **Ventilate the working area well in case the refrigerant leaks during installation.**
 If the refrigerant contacts the fire, toxic gas is produced.
 In case of R32, the refrigerant could be ignited because of its flammability.
- **Install the unit in a location that can hold heavy weight.**
 Improper installation may cause the unit to fall leading to accidents.
- **Install the unit properly in order to be able to withstand strong winds such as typhoons, and earthquakes.**
 Improper installation may cause the unit to fall leading to accidents.
- **Do not mix air in to the cooling cycle on installation or removal of the air-conditioner.**
 If air is mixed in, the pressure in the cooling cycle will rise abnormally and may cause explosion and injuries.
- **Be sure to have the electrical wiring work done by qualified electrical installer, and use exclusive circuit.**
 Power source with insufficient capacity and improper work can cause electric shock and fire.
- **Use specified wire for electrical wiring, fasten the wiring to the terminal securely, and hold the cable securely in order not to apply unexpected stress on the terminal.**
 Loose connections or hold could result in abnormal heat generation or fire.
- **Arrange the electrical wires in the control box properly to prevent them from rising. Fit the lid of the services panel properly.**
 Improper fitting may cause abnormal heat and fire.
- **Check for refrigerant gas leakage after installation is completed.**
 If the refrigerant gas leaks into the house and comes in contact with a fan heater, a stove, or an oven, toxic gas is produced.
- **Use the specified pipe, flare nut, and tools for R32 or R410A.**
 Using existing parts (R22) could cause the unit failure and serious accident due to explosion of the cooling cycle.
- **Tighten the flare nut according to the specified method by with torque wrench.**
 If the flare nut were tightened with excess torque, it could cause burst and refrigerant leakage after a long period.
- **Do not put the drainage pipe directly into drainage channels where poisonous gases such as sulfide gas can occur.**
 Poisonous gases will flow into the room through drainage pipe and seriously affect the user's health and safety. This can also cause the corrosion of the indoor unit and a resultant unit failure or refrigerant leak.
- **Connect the pipes for refrigeration circuit securely in installation work before compressor is operated.**
 If the compressor is operated when the service valve is open without connecting the pipe, it could cause explosion and injuries due to abnormal high pressure in the system.
- **Stop the compressor before removing the pipe after shutting the service valve on pump down work.**
 If the pipe is removed when the compressor is in operation with the service valve open, air would be mixed in the refrigeration circuit and it could cause explosion and injuries due to abnormal high pressure in the cooling cycle.
- **Only use prescribed option parts. The installation must be carried out by the qualified installer.**
 If you install the system by yourself, it can cause serious trouble such as water leaks, electric shocks, fire.
- **Do not repair by yourself. And consult with the dealer about repair.**
 Improper repair may cause water leakage, electric shock or fire.
- **Consult the dealer or a specialist about removal of the air-conditioner.**
 Improper installation may cause water leakage, electric shock or fire.
- **Turn off the power source during servicing or inspection work.**
 If the power is supplied during servicing or inspection work, it could cause electric shock and injury by the operating fan.
- **Do not run the unit when the panel or protection guard are taken off.**
 Touching the rotating equipment, hot surface, or high voltage section could cause an injury to be caught in the machine, to get burned, or electric shock.
- **Shut off the power before electrical wiring work.**
 It could cause electric shock, unit failure and improper turning.

⚠️CAUTION

- **Perform earth wiring surely.**
 Do not connect the earth wiring to the gas pipe, water pipe, lightning rod and telephone earth wiring. Improper earth could cause unit failure, electric shock and fire due to a short circuit.
- **Earth leakage breaker must be installed.**
 If the earth leakage breaker is not installed, it can cause fire and electric shocks.
- **Use the circuit breaker of correct capacity. Circuit breaker should be the one that disconnect all poles under over current.**
 Using the incorrect one could cause the system failure and fire.
- **Do not use any materials other than a fuse of correct capacity where a fuse should be used.**
 Connecting the circuit by wire or copper wire could cause unit failure and fire.
- **Do not install the indoor unit near the location where there is possibility of flammable gas leakages.**
 If the gas leaks and gathers around the unit, it could cause fire.
- **Do not install and use the unit where corrosive gas (such as sulfurous acid gas etc.) or flammable gas (such as thinner, petroleum etc.) may be generated or accumulated, or volatile flammable substances are handled.**
 It could cause the corrosion of heat exchanger, breakage of plastic parts etc. And inflammable gas could cause fire.
- **Secure a space for installation, inspection and maintenance specified in the manual.**
 Insufficient space can result in accident such as personal injury due to falling from the installation place.
- **Do not use the indoor unit at the place where water splashes such as laundry.**
 Indoor unit is not waterproof. It could cause electric shock and fire.
- **Do not use the indoor unit for a special purpose such as food storage, cooling for precision instrument, preservation of animals, plants, and a work of art.**
 It could cause the damage of the items.
- **Do not install nor use the system near equipments which generate electromagnetic wave or high harmonics.**
 Equipments like inverter equipment, private power generator, high-frequency medical equipment, or telecommunication equipment might influence the air-conditioner and cause a malfunction and breakdown. Or the air-conditioner might influence medical equipments or telecommunication equipments, and obstruct their medical activity or cause jamming.
- **Do not install the remote control at the direct sunlight.**
 It could cause breakdown or deformation of the remote control.
- **Do not install the indoor unit at the place listed below.**
 - Places where flammable gas could leak.
 - Places where carbon fiber, metal powder or any powder is floated.
 - Place where the substances which affect the air-conditioner are generated such as sulfide gas, chloride gas, acid, alkali or ammoniac atmospheres.
 - Places exposed to oil mist or steam directly.
 - On vehicles and ships
 - Places where machinery which generates high harmonics is used.
 - Places where cosmetics or special sprays are frequently used.
 - Highly salted area such as beach.
 - Heavy snow area.
 - Places where the system is affected by smoke from a chimney.
 - Altitude over 1000m
- **Do not install the indoor unit in the locations listed below (Be sure to install the indoor unit according to the installation manual for each model because each indoor unit has each limitation)**
 - Locations with any obstacles which can prevent inlet and outlet air of the unit.
 - Locations where vibration can be amplified due to insufficient strength of structure.
 - Locations where the infrared receiver is exposed to the direct sunlight or the strong light beam. (in case of the infrared specification unit)
 - Locations where an equipment affected by high harmonics is placed. (TV set or radio receiver is placed within 5m)
 - Locations where drainage cannot run off safely. It can affect performance or function and etc..
 - Do not install the motion sensor at following places. It could cause detection error, incapacity of detection, or characteristic degradation.
 - Place where vibration is applied to it for a long period of time.
 - Place where static electricity or electromagnetic wave generates.
 - Place where it is exposed to high temperature or humidity for a long period of time.
 - Dusty place or where the lens face could be fouled or damaged.
- **Do not put any valuables which will break down by getting wet under the air-conditioner.**
 Condensation could drop when the relative humidity is higher than 80% or drain pipe is clogged, and it damages user's belongings.
- **Do not use the base frame for the outdoor unit which is corroded or damaged after a long period of use.**
 It could cause the unit falling down and injury.
- **Pay attention not to damage the drain pan by weld sputter when brazing work is done near the unit.**
 If sputter entered into the unit during brazing work, it could cause damage (pinhole) of drain pan and leakage of water. To avoid damaging, keep the indoor unit packed or cover the indoor unit.
- **Install the drain pipe to drain the water surely according to the installation manual.**
 Improper connection of the drain pipe may cause dropping water into room and damaging user's belongings.
- **Do not share the drain pipe for indoor unit and GHP (Gas Heat Pump system) outdoor unit.**
 Toxic exhaust gas would flow into room and it might cause serious damage (some poisoning or deficiency of oxygen) to user's health and safety.
- **Be sure to perform air tightness test by pressurizing with nitrogen gas after completed refrigerant piping work.**
 If the density of refrigerant exceeds the limit in the event of refrigerant leakage in the small room, lack of oxygen can occur, which can cause serious accidents.
- **For drain pipe installation, be sure to make descending slope of greater than 1/100, not to make traps, and not to make air-bleeding.**
 Check if the drainage is correctly done during commissioning and ensure the space for inspection and maintenance.
- **Ensure the insulation on the pipes for refrigeration circuit so as not to condense water.**
 Incomplete insulation could cause condensation and it would wet ceiling, floor, and any other valuables.
- **Do not install the outdoor unit where is likely to be a nest for insects and small animals.**
 Insects and small animals could come into the electronic components and cause breakdown and fire. Instruct the user to keep the surroundings clean.
- **Pay extra attention, carrying the unit by hand.**
 Carry the unit with 2 people if it is heavier than 20kg. Do not use the plastic straps but the grabbing place, moving the unit by hand. Use protective gloves in order to avoid injury by the aluminum fin.
- **Make sure to dispose of the packaging material.**
 Leaving the materials may cause injury as metals like nail and woods are used in the package.
- **Do not operate the system without the air filter.**
 It may cause the breakdown of the system due to clogging of the heat exchanger.
- **Do not touch any button with wet hands.**
 It could cause electric shock.
- **Do not touch the refrigerant piping with bare hands when in operation.**
 The pipe during operation would become very hot or cold according to the operating condition, and it could cause a burn or frostbite.
- **Do not clean up the air-conditioner with water.**
 It could cause electric shock.
- **Do not turn off the power source immediately after stopping the operation.**
 Be sure to wait for more than 5 minutes. Otherwise it could cause water leakage or breakdown.
- **Do not control the operation with the circuit breaker.**
 It could cause fire or water leakage. In addition, the fan may start operation unexpectedly and it may cause injury.

① Before installation

- Install correctly according to the installation manual.
- Confirm the following points:
 - Unit type/Power supply specification
 - Pipes/Wires/Small parts
 - Accessory items

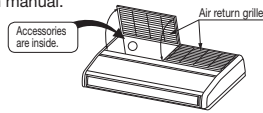

Accessory item

For unit hanging		For refrigerant pipe				For drain pipe				For air return grille	
Pat washer (M10)	Paper pattern	Pipe cover (large)	Pipe cover (small)	Strap	Drain hose (with clamp)	Hose clamp	Fixing bracket	Screw	Heavy insulation	Screw	
8	1	1	1	4	1	1	1	2	1	4	
For unit hanging	For unit hanging and adjustment	For heat insulation of gas pipe	For heat insulation of liquid pipe	For fixing of pipe cover	For drain pipe connection	For drain hose mounting	For fixing of drain hose	For installing of fixing bracket	For drain hose	For fixing air return grille	

② Selection of installation location for the indoor unit

- Select the suitable areas to install the unit under approval of the user.
 - Areas where the indoor unit can deliver hot and cold wind sufficiently. Suggest to the user to use a circulator if the ceiling height is over 3m to avoid warm air being accumulated on the ceiling.
 - In case of having the motion sensor, the installation height must be no higher than 4 m. It could reduce the sensitivity of motion sensor, disabling the detection.
 - Areas where there is enough space to install and service.
 - Areas where it can be drained properly. Areas where drain pipe descending slope can be taken.
 - Areas where there is no obstruction of airflow on both air return grille and air supply port.
 - Areas where fire alarm will not be accidentally activated by the air-conditioner.
 - Areas where the supply air does not short-circuit.
 - Areas where it is not influenced by draft air.
 - Areas not exposed to direct sunlight.
 - Areas where dew point is lower than around 28°C and relative humidity is lower than 80%. This indoor unit is tested under the condition of JIS (Japan Industrial Standard) high humidity condition and confirmed there is no problem. However, there is some risk of condensation drop if the air-conditioner is operated under the severer condition than mentioned above.
 - If there is a possibility to use it under such a condition, attach additional insulation of 10 to 20mm thick for entire surface of indoor unit, refrigeration pipe and drain pipe.
 - Areas where TV and radio stays away more than 1m. (It could cause jamming and noise.)
 - Areas where any items which will be damaged by getting wet are not placed such as food, table wares, server, or medical equipment under the unit.
 - Areas where there is no influence by the heat which cookware generates.
 - Areas where not exposed to oil mist, powder and/or steam directly such as above fryer.
 - Areas where lighting device such as fluorescent light or incandescent light doesn't affect the operation. (A beam from lighting device sometimes affects the infrared receiver for the wireless remote control and the air conditioner might not work properly.)
- Check if the place where the air conditioner is installed can hold the weight of the unit. If it is not able to hold, reinforce the structure with boards and beams strong enough to hold it. If the strength is not enough, it could cause injury due to unit falling.
- If there are 2 units of wireless type, keep them away for more than 6m to avoid malfunction due to cross communication.
- When plural indoor units are installed nearby, it is recommended to separate each other more than 4m.

Space for installation and service

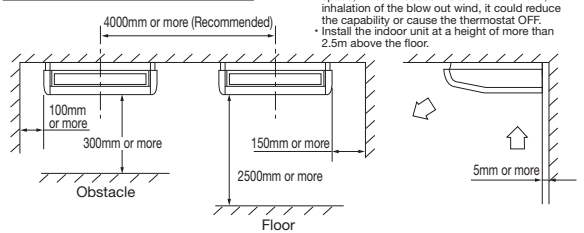

* In case of not installing in the above installation space, it could reduce the airflow volume or, inhalation of the blow out wind, it could reduce the capability or cause the thermostat OFF.
 * Install the indoor unit at a height of more than 2.5m above the floor.

③ Preparation before installation

- If suspension bolt becomes longer, do reinforcement of earthquake resistant.
 - For grid ceiling
When suspension bolt length is over 500mm, or the gap between the ceiling and roof is over 700mm, apply earthquake resistant brace to the bolt.
 - In case the unit is hung directly from the slab and is installed on the ceiling plane which has enough strength.
When suspension bolt length is over 1000mm, apply the earthquake resistant brace to the bolt.
- Prepare four (4) sets of suspension bolt, nut and spring washer (M10) on site.

Pitch of suspension bolts and pipe position

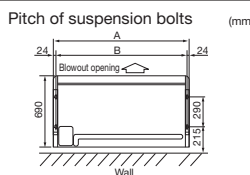

Location of pipe outlets

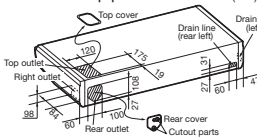

③ Preparation before installation (continued)

Series	type	(mm)	
		A	B
Single Split (PAC) series	40 to 50type	1070	1022
	60 to 71type	1320	1272
	100 to 140type	1620	1572
VRF (KX) series	36 to 56type	1070	1022
	71type	1320	1272
	112 to 140type	1620	1572

※Pipes can be taken out in 3 directions (rear, right or top).

- Cut out holes using nippers, etc.
- Cut out holes to take out pipes along the cutoff line on the rear cover.
- Cut out the top face cover aligning to the piping position.
- When taking pipe out to right-hand side, cut out a hole along the groove at the inside of side panel.
- After installing pipes and wires, seal clearances around pipes and wires with putty, etc. to shut off dust.

Pipe position (mm)

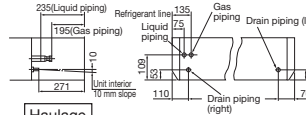

Make sure to install the covers at rear and top in order to protect the inside of unit from intrusion of dust or protect wires from damages by sharp edges. When taking them out to the right-hand side, remove burrs or sharp edges from the cutout.

Haulage

- Move the box as close to the installation area as possible packed.
- If it must be unpacked, wrap the unit with a nylon sling, and be careful not to damage the unit.
 - ※ Do not hold fragile plastic parts, such as the side panel, blow louver, etc.
- If you need to lay the unit on a floor after unpacking, always put it with the intake grille facing upward.



Preparation before installation

1. Remove the air return grille.

Slide stoppers (4 places) of the catches, then pull out the pins (4 or 6 places).

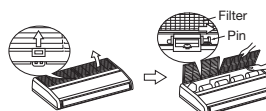

2. Remove the side panel.

Remove the screw and detach the side panel by sliding it toward the direction indicated by the arrow mark.

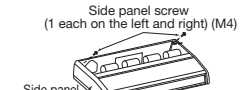

3. Remove the hanging plate.

Remove the screw, and then loosen the fixing bolts.

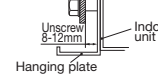

4. Remove the side panel.

Remove the screw and detach the side panel by sliding it toward the direction indicated by the arrow mark.



④ Installation of indoor unit

WARNING

Completely seal the hole in the wall with putty. If not sealed properly, dust, insects, small animals, and highly humid air may enter the room from outside, which could result in fire or other hazards.

CAUTION

Completely seal the hole in the wall with putty. If not sealed properly, furniture and other fixtures may be damaged by water leakage or condensation.

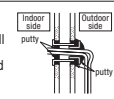

Work procedure

- Select the suspension bolt locations and the pipe hole location.
 - (1) Use enclosed paper pattern as a reference, and drill the holes for the suspension bolts and pipe.
 - ※ Decide the locations based on direct measurements.
 - (2) Once the locations are properly placed, the paper pattern can be removed.
- Install the suspension bolts in place.
- Fix with 4 suspension bolts.
- Check the measurements given at the right figure for the length of the suspension bolts.
- Fasten the hanging plate onto the suspension bolts.

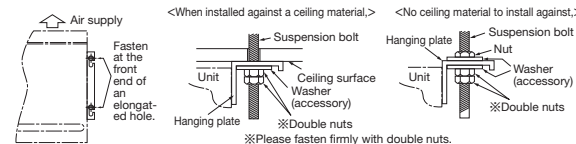
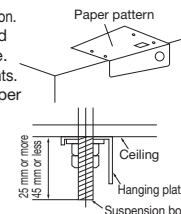

6. Install the unit to the hanging plate. (See the figure at right.)

- (1) Slide the unit in from front side to get it hanged on the hanging plate with the bolts.
- (2) Fasten the four fixing bolts (M8: 2 each on the left and right sides) firmly.
- (3) Fasten the two screws (M4: 1 each on the left and right sides).

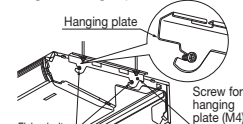

▲ **WARNING** : Hang a side panel on from the panel side to the rear side and then fasten it securely onto the indoor unit with screws.

※ To ensure smooth drain flow, install the unit with a descending slope toward the drain outlet.

▲ **CAUTION** : Do not give the reversed slope, which may cause water leaks.

⑤ Refrigerant pipe

Caution

- Be sure to use new pipes for the refrigerant pipes. Use the flare nut attached to the product. Regarding whether existing pipes can be reused or not, and the washing method, refer to the instruction manual of the outdoor unit, catalogue or technical data.
 - 1) In case of reuse: Do not use old flare nut, but use the one attached to the unit.
 - 2) In case of reuse: Flare the end of pipe replaced partially for R32 or R410A.
- ⚠ **WARNING** : When flared joints are reused indoors, the flare part shall be re-fabricated. (only for R32)

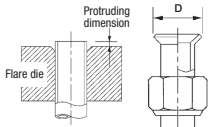

Pipe diameter d mm	Min. pipe wall thickness mm	Protruding dimension for flares, mm		Flare O.D. D mm	Flare nut tightening torque N·m
		Rigid (Clutch type) For R32 For R410A	Conventional tool		
6.35	0.8	0 - 0.5	0.7 - 1.3	8.9 - 9.1	14 - 18
9.52	0.8			12.8 - 13.2	34 - 42
12.7	0.8			16.2 - 16.6	49 - 61
15.88	1			19.3 - 19.7	68 - 82
19.05	1.2			23.6 - 24.0	100 - 120

- Use phosphorus deoxidized copper alloy seamless pipe (C1220T) for refrigeration pipe installation. In addition, make sure there is no damage both inside and outside of the pipe, and no harmful substances such as sulfur, oxide, dust or a contaminant stuck on the pipes.
- Do not use any refrigerant other than R32 or R410A.
- Using other refrigerant except R32 or R410A (R22 etc.) may degrade inside refrigeration oil. And air getting into refrigeration circuit may cause over-pressure and resultant it may result in bursting, etc.
- Store the copper pipes indoors and seal the both end of them until they are brazed in order to avoid any dust, dirt or water getting into pipe. Otherwise it will cause degradation of refrigeration oil and compressor breakdown, etc.
- Use special tools for R32 or R410A refrigerant.

Work procedure

1. Remove the flare nut and blind flanges on the pipe of the indoor unit.
 - ※ Make sure to loosen the flare nut with holding the nut on pipe side with a spanner and giving torque to the nut with another spanner in order to avoid unexpected stress to the copper pipe, and then remove them. (Gas may come out at this time, but it is not abnormal.)
 - Pay attention whether the flare nut pops out. (as the indoor unit is sometimes pressurized.)
 - Make a flare on liquid pipe and gas pipe, and connect the refrigeration pipes on the indoor unit.
 - When pulling out pipes backward or upward, install them passing through the attached cover together with the electrical cabling.
 - Seal the gap with putty, or other, to protect from dust, etc.
 - ※ Bend radius of pipe must be 4D or larger. Once a pipe is bent, do not readjust the bending. Do not twist a pipe or collapse to 2/3D or smaller.
 - Make sure to use flare nuts assembled on the unions. Usage of other flare nuts could cause refrigerant leakage.
 - ※ Do a flare connection as follows:
 - Make sure to hold the nut on indoor unit pipe side using double spanner method as indicated when fastening / loosening flare nuts in order to prevent unintentional twisting of the copper pipe.
 - When fastening the flare nut, align the refrigeration pipe with the center of flare nut, screw the nut for 3-4 times by hand and then tighten it by spanner with the specified torque mentioned in the table above.
3. Cover the flare connection part of the indoor unit with attached insulation material after a gas leakage inspection, and tighten both ends with attached straps.
 - Make sure to insulate both gas pipes and liquid pipes completely.
 - ※ Incomplete insulation may cause dew condensation or water drooping.
 - Use heat-resistant (120 °C or more) insulations on the gas side pipes.
 - In case of using at high humidity condition, reinforce insulation of refrigerant pipes. Surface of insulation may cause dew condensation or water drooping, if insulations are not reinforced.
4. Refrigerant is charged in the outdoor unit. As for the additional refrigerant charge for the indoor unit and piping, refer to the installation manual attached to the outdoor unit.

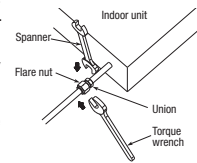

Caution:
Refrigerating machine oil should not be applied to the threads of union or external surface of flare. It is because, even if the same tightening torque is applied, the oil is likely to decrease the side friction force on the threads and increase, in turn, the axial component force so that it could crack the flare by the stress corrosion.
Refrigerating machine oil may be applied to the internal surface of flare only.

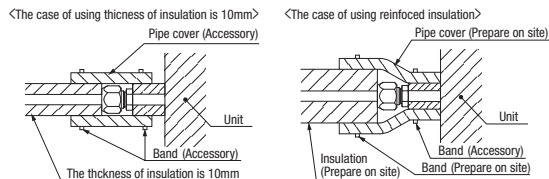

- The pipe can be connected from three different directions. (back, right, top)
- When the pipe is routed through the back. If the bracket is removed, piping work will become easy. ※After piping, reinstall the removed bracket.

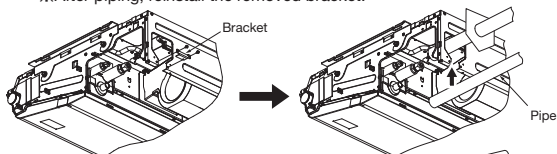

- When the pipe is routed through the top. Cut the removed top cover, and install to the rear panel instead of rear cover.

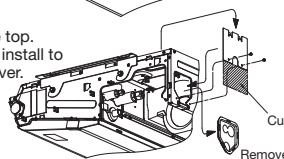

⑥ Drain pipe

- The drain pipes may pull out either from back, right or left side.

Caution

- Install the drain pipe according to the installation manual in order to drain properly. Imperfection in draining may cause flood indoors and wetting the household goods, etc.
- Do not put the drain pipe directly into the ditch where toxic gas such as sulfur, the other harmful and inflammable gas is generated. Toxic gas would flow into the room and it would cause serious damage to user's health and safety (some poisoning or deficiency of oxygen). In addition, it may cause corrosion of heat exchanger and bad smell.
- Connect the pipe securely to avoid water leakage from the joint.
- Insulate the pipe properly to avoid condensation drop.
- Check if the water can flow out properly from both the drain outlet on the indoor unit and the end of the drain pipe after installation.
- Make sure to make descending slope of greater than 1/100 and do not make up-down bend and/or trap in the midway. In addition, do not put air vent on the drain pipe. Check if water is drained out properly from the pipe during commissioning. Also, keep sufficient space for inspection and maintenance.

Work procedure

1. Insert drain hose completely to the base, and tighten the drain hose clamp securely. (adhesive must not be used.)
 - ※ When plumbing on the left side, move the rubber plug and the cylindrical insulating materials by the pipe connecting hole on the left side of the unit to the right side.
- △ Beware of a possible outflow of water that may occur upon removal of a drain plug.
 - Take head of electrical cables so that they may not run beneath the drain hose.
2. Fix the drain hose at the lowest point with a hose clamp supplied as an accessory.
 - ※ Give a drain hose a gradient of 10mm as illustrated in the right drawing by laying it without leaving a slack.
- Insulate the drain pipe with the heat insulation supplied as accessories.
- △ A drain hose must be clamped down with a hose clamp. There is a possibility that drain water overflows.
 - When the unit is installed in a humid place, consider precautions against dew condensation such as heat insulation for the drain pipe.
3. Connect VP20(prepare on site) to drain hose. (Adhesive must not be used.)
 - ※ Use commercially available rigid PVC general pipe VP20 for drain pipe.
4. Do not to make the up-down bending and trap in the mid-way while assuming that the drain pipes is downhill. (more than 1/100)
 - Never set up air vent.
5. Insulate the drain pipe.

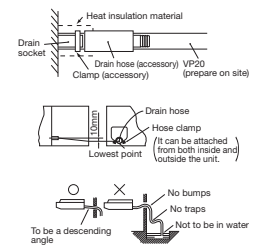

Drain test

- After installation of drain pipe, make sure that drain system work in good condition and no water leakage from joint and drain pan.
- Do drain test even if installation of heating season.

⑦ Wiring-out position and wiring connection

- Electrical installation work must be performed according to the installation manual by an electrical installation service provider qualified by a power provider of the country, and be executed according to the technical standards and other regulations applicable to electrical installation in the country. Be sure to use an exclusive circuit.
 - Use specified cord, fasten the wiring to the terminal securely, and hold the cord securely in order not to apply unexpected stress on the terminal.
 - Do not put both power source line and signal line on the same route. It may cause miscommunication and malfunction.
 - Be sure to do D type earth work.
 - For the details of electrical wiring work, see attached instruction manual for electrical wiring work.
1. Remove wiring from clips.
 2. Remove the control box (Screw ①, 2pcs).
 3. Pull out the control box by sliding along the groove on the bracket (Direction A→B).
 4. Remove the lid of control box (Screw ②, 2pcs).
 5. Hold each wiring inside the unit and connect to the terminal block surely.
 6. Fix the wiring by clamp.
 7. Install the lid of control box (Screw ②, 2pcs).
 8. Return the control box to the original place by sliding along the groove on the bracket (Direction B→A).
 9. Install the removed parts at their original places.
- ※ 1 Wiring for the signal receiving section of wireless kit (Option) and motion sensor kit (Option) are connected at the time of shipping from the factory. It is not necessary to disconnect these wiring when wired remote control is connected. When the wired/wireless kits are used together, it becomes necessary to set the slaves and remote control. For the methods of installing the wireless kit and the motion sensor kit, refer to the attached installation manuals.

NOTICE

When installing the Superlink adapter, remove the band fixed the wiring from receiver.

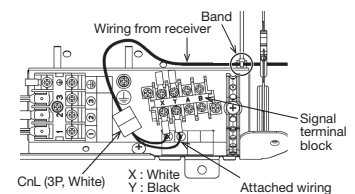

⑦ Wiring-out position and wiring connection (continued)

- FDE (small) Clip

FDE (medium) Clip

FDE (large) Clip
- Screw ① Screw ①
- Control box Sliding Method

Bracket

※ Disconnect each wiring from clips before pulling out the control box.
- Screw ② Lid of control box Screw ②
- 5 · 6. Single split (PAC) Series

CnL connector (3P, white) Earth Signal side terminal block Wireless and motion sensor receiver line (※1) Remote control line Wiring between indoor and outdoor unit. Wiring clamp
- VRF (KX) Series

CnL connector (3P, white) Power source side terminal block Earth Signal side terminal block Signal line (Shielded cord) Remote control line Indoor power source line Wiring clamp
- 7 · 8. Control box hook

Screw ② Screw ②

※ Install it as to fit the form of control box.

⑧ Control mode switching

• The control content of indoor units can be switched in following way. (is the default setting)

Switch No.	Control Content	
SW8-4	ON	Indoor unit silent mode
	OFF	Normal operation

⑨ Attaching the air return grille

• The air return grille must be attached when electrical cabling work is completed.

- Fix the chains tied to the air return grille onto the indoor unit with screws supplied as accessories (4 pieces).
- Close the air return grille. This completes the unit installation work.

Fix with screws Chain Chain Chain Chain

Fixed section of chain

⑩ Check list after installation

• Check the following items after all installation work completed.

Check if	Expected trouble	Check
The indoor and outdoor units are fixed securely?	Falling, vibration, noise	
Inspection for leakage is done?	Insufficient capacity	
Insulation work is properly done?	Water leakage	
Water is drained properly?	Water leakage	
Power source voltage is same as mentioned in the model name plate?	PCB burnt out, not working at all	
There is mis-wiring or mis-connection of piping?	PCB burnt out, not working at all	
Earth wiring is connected properly?	Electric shock	
Cable size comply with specified size?	PCB burnt out, not working at all	
Any obstacle blocks air flow on air inlet and outlet?	Insufficient capacity	

■ Effective range of cool/hot wind (Reference)

FDE series

Model	Effective range
FDE50VH	7.5m

- [Conditions]
- Height of unit: 2.4 – 3.0 (m) above floor level
 - Fan speed : Hi
 - Location: Free space without obstacles
 - The effective range means the horizontal distance for wind to reach the floor.
 - Wind speed at the effective range: 0.5 m/s

(7) Electric wiring work installation (FDTC, FDUM, FDE)

PSC012D117

Electrical wiring work must be performed by an electrician qualified by a local power provider according to the electrical installation technical standards and interior wiring regulations applicable to the installation site.

Security instructions

- Read the "SAFETY PRECAUTIONS" carefully first of all and then strictly follow it during the installation work in order to protect yourself.
- The precautionary items mentioned below are distinguished into two levels, **WARNING** and **CAUTION**.
 - WARNING** : Wrong installation would cause serious consequences such as injuries or death.
 - CAUTION** : Wrong installation might cause serious consequences depending on circumstances. Both mentions the important items to protect your health and safety so strictly follow them by any means.
- The meanings of "Marks" used here are as shown on the right:
 - ⊘ Never do it under any circumstances.
 - ⊙ Always do it according to the instruction.
- Accord with following items. Otherwise, there will be the risks of electric shock and fire caused by overheating or short-circuit.

WARNING

- Be sure to have the electric wiring work done by qualified electrical installer, and use exclusive circuit. ⊘
Power source with insufficient capacity and improper work can cause electric shock and fire.
- Use specified wire for electrical wiring, fasten the wiring to the terminal securely, and hold the cable securely in order not to apply unexpected stress on the terminal. ⊘
Loose connections or hold could result in abnormal heat generation or fire.
- Arrange the electrical wires in the control box properly to prevent them from rising. Fit the lid of the services panel properly. ⊘
Improper fitting may cause abnormal heat and fire.
- Use the genuine option parts. And installation should be performed by a specialist. ⊘
If you install the unit by yourself, it could cause water leakage, electric shock and fire.
- Do not repair by yourself. And consult with the dealer about repair. ⊘
Improper repair may cause water leakage, electric shock or fire.
- Consult the dealer or a specialist about removal of the air-conditioner. ⊘
Improper installation may cause water leakage, electric shock or fire.
- Turn off the power source during servicing or inspection work. ⊘
If the power is supplied during servicing or inspection work, it could cause electric shock and injury by the operating fan.
- Shut off the power before electrical wiring work. ⊘
It could cause electric shock, unit failure and improper running.

CAUTION

- Perform earth wiring surely. ⊙
Do not connect the earth wiring to the gas pipe, water pipe, lightning rod and telephone earth wiring. Improper earth could cause unit failure and electric shock due to a short-circuit.
- Earth leakage breaker must be installed. ⊘
If the earth leakage breaker is not installed, it can cause electric shocks.
- Make sure to install earth leakage breaker on power source line. (countermeasure thing to high harmonics.) ⊘
Absence of breaker could cause electric shock.
- Use the circuit breaker of correct capacity. Circuit breaker should be the one that disconnect all poles under over current. ⊘
Using the incorrect one could cause the system failure and fire.
- Do not use any materials other than a fuse of correct capacity where a fuse should be used. ⊘
Connecting the circuit by wire or copper wire could cause unit failure and fire.
- Use power source line of correct capacity. ⊘
Using incorrect capacity one could cause electric leak, abnormal heat generation and fire.
- Do not mingle solid cord and stranded cord on power source and signal side terminal block. ⊘
In addition, do not mingle difference capacity solid or stranded cord. Inappropriate cord setting could cause loosening screw on terminal block, bad electrical contact, smoke and fire.
- Do not turn off the power source immediately after stopping the operation. ⊘
Be sure to wait for more than 5 minutes. Otherwise it could cause water leakage or breakdown.
- Do not control the operation with the circuit breaker. ⊘
It could cause fire or water leakage. In addition, the fan may start operation unexpectedly and it may cause injury.

Control mode switching

● The control content of indoor units can be switched in following way. (is the default setting)

Switch No.	Control Content	
SW2	Indoor unit address (0-Fh)	
SW5-1	Master/Slave Switching (plural /Slave unit Setting)	
SW5-2		
SW6-1-4	Model capacity setting	
SW7-1	ON	Operation check, Drain motor test run
	OFF	Normal operation

① Electrical wiring connection

- Electrical wiring work must be performed by an electrician qualified by a local power provider. These wiring specifications are determined on the assumption that the following instructions are observed:
 - Do not use cords other than copper ones.
 - Do not use any source line lighter than one specified in parentheses for each type below.
 - braided cord (code designation 60245 IEC 51), if allowed in the relevant part 2;
 - ordinary tough rubber sheathed cord (code designation 60245 IEC 53);
 - flat twin tinsel cord (code designation 60227 IEC 41);
 - ordinary polyvinyl chloride sheathed cord (code designation 60227 IEC 53);
 - Connect the power source to the outdoor unit.
 - Pay extra attention so as not to confuse signal line and power source line connection, because an error in their connection can be burn all the boards at once.
- Connect ground wires before connecting wires between the indoor and outdoor units and between indoor units. The ground wires need to be longer than the wires between the indoor and outdoor units, and protected from undue stress.
- Do not turn on the power source before completing the work.
- The ground wires must be connected by the Class D grounding connection.
- Use the round crimp terminals for connections to the terminal block.
- Use dedicated branch circuits, avoiding combination with other devices. Otherwise, it could trip the power source breaker, resulting in secondary accidents.
- Install the overcurrent and earth leakage breakers (sensitivity current: 30 mA) specified to respective models.
- Do not connect indoor and outdoor signal cables to extension cables on the way. If the joint is wetted with intruding water, it could cause a ground insulation failure or poor connection, resulting in communication errors. (If it is inevitable to connect cables on the way, make sure to prevent the water intrusion completely.)
- When running wires (wires for power source, remote controller, connecting between indoor and outdoor units, or other) behind the ceiling, protect them using copper or other pipes against assault by rat, or other.
- It is up to 3.5 mm² the size of power supply cables connected to indoor units. When using cables of 5.5 mm² or larger, provide a dedicated pull box for branching connection to indoor units.
- If signal and power source cables are connected mistakenly, it could burn down all PCBs.
 - Even if the power source of 220/240/380/415 V is connected mistakenly to A-B signal cable, it is protected at initial occasion only.
 - If the remote control fails to detect the unit No. (address) at 15 minutes after turning the power on, check and repair all signal cables for misconnection.
 - Cut the jumper wire J10S1 of burnt PCB, and reconnect connectors CnK (yellow) and CnK1 (white) to CnK2 (black).
 - If any anomaly is found on wires between the A-B terminal block and the PCB, replace them.
- At the outside of indoor and outdoor units, take care to avoid direct contacts between remote control and power source cables.
- In no event connect the power source of 220/240/380/415 V to the remote control terminal block. It could cause failures.
- Connections of wiring between units, ground wire and remote control cable
 - When connecting wires between units, ground wire or remote control wire, connect them according to the number of terminals on the power source terminal block or signal terminal block in the control box. Connect the ground wire to the ground terminal on the power source terminal block.
 - Make sure to install an earth leakage breaker for the power source. Select a breaker for inverter circuit.
 - When the earth leakage breaker is exclusive for the earth leakage protection, it is necessary to connect also an isolating switch (Switch + Class B fuse) or wiring circuit breaker in series to the earth leakage breaker.
 - Install the isolating switch close to the unit.
- Connect wires securing by tightening screws firmly. Confirm also no connector or wire (from terminal) is disconnected in the control box.
- When installing an auxiliary electric heater, consult the electric heater manual or technical data.

Cable connection for single unit installation

- As for connecting method of power source, select from following connecting patterns. In principle, do not directly connect power source line to inside unit.
 - As for exceptional connecting method of power source, discuss with the power provider of the country with referring to technical documents, and follow its instruction.
- For cable size and circuit breaker selection, refer to the outdoor unit installation manual.

Single-phase model

Three-phase model

Cable connection for a V multi configuration installation

- Connect the same pairs number of terminal block "①", "②", and "③" and "ⓧ" and "⓪" between master and slave indoor units.
- Do the same address setting of all inside units belong to same refrigerant system by rotary switch SW2 on indoor unit's PCB (Printed circuit board).
- Set slave indoor unit as "slave 1" through "slave 3" by address switch SW5-1, 5-2 on PCB.
- When the AIR CON No. button on the remote control unit is pressed after turning on the power, an indoor unit's address number will be displayed. Do not fail to confirm that the connected indoor unit's numbers are displayed on the remote control unit by pressing the ▲ or ▼ button.

Power source

Method of setting Master/Slave of indoor unit

(Factory setting: "Master")

Indoor unit	Master	Slave 1	Slave 2	Slave 3
PCB switch	SW5-1	OFF	OFF	ON
	SW5-2	OFF	ON	ON

Twin type Triple type Double twin type

② Remote control, wiring and functions

- Do not install it on the following places
 - ① Places exposed to direct sunlight
 - ② Places near heat devices
 - ③ High humidity places
 - ④ Hot surface or cold surface enough to generate condensation
 - ⑤ Places exposed to oil mist or steam directly.
 - ⑥ Uneven surface

Installation and wiring of remote control

- ① Install remote control referring to the attached installation manual.
- ② Wiring of remote control should use 0.3mm² × 2 core wires or cables.
The insulation thickness is 1mm or more. (on-site configuration)
- ③ Maximum prolongation of remote control wiring is 600m.
If the prolongation is over 100m, change to the size below.
But, wiring in the remote control case should be under 0.5mm². Change the wire size outside of the case according to wire connecting. Waterproof treatment is necessary at the wire connecting section. Be careful about contact failure.

100 - 200m	0.5mm ² × 2 cores
Under 300m	0.75mm ² × 2 cores
Under 400m	1.25mm ² × 2 cores
Under 600m	2.0mm ² × 2 cores
- ④ Avoid using multi-core cables to prevent malfunction.
- ⑤ Keep remote control line away from earth (frame or any metal of building).
- ⑥ Make sure to connect remote control line to the remote control and terminal block of indoor unit. (No polarity)

Control plural indoor units by a single remote control

- ① A remote control can control plural indoor units (Up to 16).
- In above setting, all plural indoor units will operate under same mode and temperature setting.
- ② Connect all indoor units with 2 core remote control line.
- ③ Set unique remote control communication address from "0" to "F" to each inside unit by the rotary switch SW2 on the indoor unit's PCB.

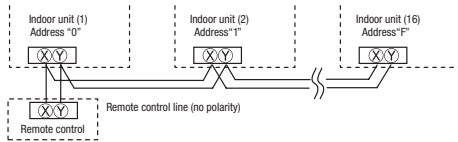

Master/ slave setting when more than one remote control unit are used

A maximum of two remote control units can be connected to one indoor unit (or one group of indoor units.)
The air-conditioner operation follows the last operation of the remote control regardless of the master/slave setting of it.
Acceptable combination is "two (2) wired remote controls", "one (1) wired remote control and one (1) wireless kit" or "two (2) wireless kits".
Set one to "Master" and the other to "Slave".
Note: The setting "Remote control unit sensor enabled" is only selectable with the master remote control unit in the position where you want to check room temperature.

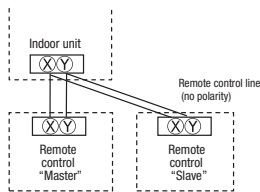

③ Operation and confirmation from remote control

No.	Item	Operation from the eco touch remote control (RC-EX series)	Operation from the standard remote control (RC-E series)
1	Check the number of units connected in the multi remote control system.	[Menu] ⇒ [Service setting] ⇒ [Service & Maintenance] ⇒ [Service password] ⇒ [IU address]	① Press the [AIR CON NO] button to display the IU address. ② Press the [▲] or [▼] button and check addresses of connected indoor units one by one.
2	Check if each unit is connected properly in the remote control system.	[Menu] ⇒ [Service setting] ⇒ [Service & Maintenance] ⇒ [Service password] ⇒ [IU address] ⇒ [Check run mode]	① Press the [AIR CON NO] button to display the IU address. ② Press the [▲] or [▼] button and select one of IU addresses. ③ Press the [MODE] button. The unit starts to blow air.
3	Setting main/sub remote controls	[Menu] ⇒ [Service setting] ⇒ [R/C function settings] ⇒ [Service password] ⇒ [Main/Sub of R/C]	Set SW1 to "Sub" for the sub remote control unit.
4	Checking operation data	[Menu] ⇒ [Service setting] ⇒ [Service & Maintenance] ⇒ [Service password] ⇒ [Operation data]	Press the [CHECK] button. ⇒ "OPER DATA ▼" is displayed. ⇒ Press the [SET] button. ⇒ "DATA LOADING" is displayed. ⇒ Select one of addresses for connected indoor units by pressing the [▲] or [▼] button. ⇒ Press the [SET] button. ⇒ "DATA LOADING" is displayed. ⇒ Select data by pressing the [▲] or [▼] button.
5	Checking inspection display	[Menu] ⇒ [Service setting] ⇒ [Service & Maintenance] ⇒ [Service password] ⇒ [Error display]	Press the [CHECK] button. ⇒ "OPER DATA ▼" is displayed. ⇒ Press the [▼] button. ⇒ "ERROR DATA ▲" is displayed. ⇒ Press the [SET] button. ⇒ "DATA LOADING" is displayed. ⇒ Data is displayed.
6	Cooling test run from remote control	[Menu] ⇒ [Service setting] ⇒ [Installation settings] ⇒ [Service password] ⇒ [Test run] ⇒ [Cooling test run] ⇒ [Start]	① Start the system by pressing the [ON/OFF] button. ② Select "Cool" with the [MODE] button. ③ Press the [TEST] button for 3 seconds or longer. The screen display will switch to "TEST RUN ▼". ④ Pressing the [SET] button, while the "TEST RUN ▼" is displayed, starts the cooling test run. The screen display will switch to "TEST RUN".
7	Trial operation of drain pump from remote control	[Menu] ⇒ [Service setting] ⇒ [Installation settings] ⇒ [Service password] ⇒ [Test run] ⇒ [Drain pump test run] ⇒ [Run]	① Start the system by pressing the [ON/OFF] button. The display will change to "TEST RUN ▼". ② Press the [▼] button once to display "DRAIN PMP ▲". ③ Pressing the [SET] button starts the drain pump operation. The display will show "STOP TO STOP".

The menu configuration may vary depending on models of the remote control. If the model of your remote control is different, refer to the installation manual attached to the remote control.

④ Function of CNT connector of indoor printed circuit board

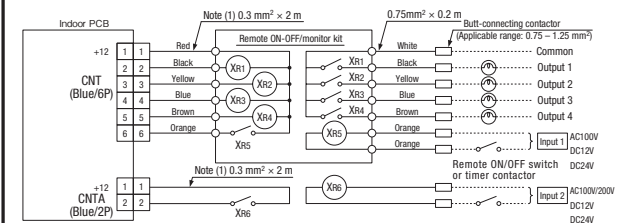

Note (1) To be no longer than 2 m.

- XR1-4 are DC 12V relays. (Equivalent to Omron's LY2F)
- XR5 is a DC 12V, 24V or 100V, 200V relay. (Equivalent to Omron's MY2F)
- Maker and model of CnT connector (Site side)
Connector : Molex 5264-06
Terminal : Molex 5263T
- CnTA connector is used on FDT, or other. <Check with the specifications.> (Site side) Maker and model
Connector : J.S.T. Mfg. XAP02V-1-E
Terminal : J.S.T. Mfg. SXA-01T-P0.6
- Output 1 - 4 and input1/2 can be selected/set as required from following items.
Factory default is set as shown below.

Output	
① RUN output	⑧ Fan ON output 3
② Heating output	⑨ Defrost/oil return output
③ Compressor ON output	⑩ Ventilation output
④ Inspection (error) output	⑪ Heater output
⑤ Cooling output	⑫ Free cleaning output
⑥ Fan ON output 1	⑬ Indoor overload error output
⑦ Fan ON output 2	

Input	
① RUN/STOP	⑤ Setting temp. shift
② RUN permit prohibition	⑥ Compulsory thermostat OFF
③ Emergency stop	⑦ Temporary stop
④ Cooling/Heating	⑧ Silent mode

Factory default setting			
CnT-2	Output 1 RUN output	CnT-5	Output 4 Inspection (error) output
CnT-3	Output 2 Heating output	CnT-6	Input 1 RUN/STOP
CnT-4	Output 3 Compressor ON output	CnTA	Input 2 RUN/STOP

● For the setting method, refer to the technical data.

5 Operation and setting from remote control

A : Refer to the instruction manual for RC-EX series ○ : Nearly same function setting and operations are possible. *1: Remote controls before RC-EX1A don't have this function.
 B : Refer to the installation manual for RC-EX series △ : Similar function setting and operations are possible. *2: Remote controls before RC-EX3 don't have this function.
 C : Loading a utility software via Internet

Setting & display item	Description	RC-EX3A	RC-E5	
1.Remote Control network				
1 Control plural indoor units by a single remote control	A remote control can control plural indoor units up to 16 (in one group of remote control network). An address is set to each indoor unit.		○	
2 Main/sub setting of remote controls	A pair of remote controls (including option wireless remote control) can be connected within the remote control network. Set one to "Main" and the other to "Sub".	B	○	
2.TOP screen, Switch manipulation				
1 Menu	"Control", "State", or "Details" can be selected. (3-8)	A		
2 Operation mode	"Cooling", "Heating", "Fan", "Dry" or "Auto" can be set.	A	○	
3 Set temp.	"Set temperature" can be set by 0.5°C interval.	A	○	
4 Air flow direction	"Air flow direction" (Individual flap control) can be set. Select Enable or Disable for the "3D AUTO" (in case of FDK). *1	A	△	
5 Fan speed	"Fan speed" can be set.	A	○	
6 Timer setting	"Timer operation" can be set.	A	○	
7 ON/OFF	"On/Off operation of the system" can be done.	A	○	
8 F1 SW	*1 The system operates and is controlled according to the function specified to the F1 switch.	A		
9 F2 SW	*1 The system operates and is controlled according to the function specified to the F2 switch.	A		
10 Select the language	*2 Select the language to display on the remote control. • Select from English, German, French, Spanish, Italian, Dutch, Turkish, Portuguese, Russian, Polish, Japanese and Chinese.	A		
3.Useful functions				
1 Individual flap control	The moving range (the positions of upper limit and lower limit) of the flap for individual flap can be set. Set also the left and right limit positions for FDK. *1	A	△	
2 Anti draft setting When the panel with the anti-draft function is assembled.	*1 • DetailsYou can set Enable or Disable for anti draft motion performed at each blow outlet in each operation mode. • ON/OFF settingYou can set ON/OFF (operation/stop) of anti draft function for the enabled blow outlet set in Details. *2	A		
3 Timer settings	Set On timer by hour	The period of time to start operation after stopping can be set. • The period of set time can be set within range of 1hour-12hours (1hr interval). • The operation mode, set temp-and fan speed at starting operation can be set.	A	△
	Set Off timer by hour	The period of time to stop operation after starting can be set. • The period of set time can be set within range of 1hour-12hours (1hr interval).	A	△
	Set On timer by clock	The clock time to start operation can be set. • The set clock time can be set by 5-minutes intervals. • [Once (one time only)] or [Everyday] operation can be switched. • The operation mode, set temp. and fan speed at starting operation can be set.	A	△
	Set Off timer by clock	The clock time to stop operation can be set. • The set clock time can be set by 5-minute intervals. • [Once (one time only)] or [Everyday] operation can be switched.	A	△
	Confirmation of timer settings	Status of timer settings can be seen.	A	
4 Favorite setting [Administrator password]	*1 Set the operation mode, setting temperature, air flow capacity and air flow direction for the choice setting operations. Set them for the Favorite set 1 and the Favorite set 2 respectively.	A		
5 Weekly timer	On timer and Off timer on weekly basis can be set. • 8-operation patterns per day can be set at a maximum. • The setting clock time can be set by 5-minute intervals. • Holiday setting is available. • The operation mode, set temp. and fan speed at starting operation can be set.	A	△	
6 Home leave mode [Administrator password]	When leaving home for a long period like a vacation leave, the unit can be operated to maintain the room temperature not to be hotter in summer or not to be colder in winter. • The judgment to switch the operation mode (Cooling ⇄ Heating) is done by the both factors of the set temp. and outdoor air temp. • The set temp. and fan speed can be set.	A		
7 External Ventilation When the ventilator is combined.	On/Off operation of the external ventilator can be done. It is necessary to set from [Menu] ⇒ [Service setting] ⇒ [R/C function settings] ⇒ [Ventilation setting]. • If the "Independent" is selected for the ventilation setting, the ventilator can be operated or stopped.	A	○	
8 Select the language	Select the language to display on the remote control. • Select from English, German, French, Spanish, Italian, Dutch, Turkish, Portuguese, Russian, Polish, Japanese and Chinese. *1	A		
9 Silent mode control	*2 The period of time to operate the unit by prioritizing the quietness can be set. • Start and end can be set for the silent mode	A		
4.Energy-saving setting				
Administrator password				
1 Sleep timer	To prevent the timer from keeping ON, set hours to stop operation automatically with this timer. • The selectable range of setting time is from 30 to 240 minutes. (10-minute intervals) • When setting is "Enable", this timer will activate whenever the ON timer is set.	A	△	
2 Peak-cut timer	Power consumption can be reduced by restructuring the maximum capacity. Set the [Start time], the [End time] and the capacity limit % (Peak-cut %). • 4-operation patterns per day can be set at maximum. • The setting time can be changed by 5-minute intervals. • The selectable range of capacity limit % (Peak-cut %) is from 0% to 40-80% (20% interval) • Holiday setting is available.	A		
3 Automatic temp set back	After the elapse of the set time period, the current set temp. will be set back to the [Set back time]. • The setting can be done in cooling and heating mode respectively. • Selectable range of the set time is from 20 min. to 120 min. (10 min. interval). • Set the [Set back temp.] by 1°C interval.	A	△	
4 Motion sensor control When the panel with the motion sensor is assembled.	*1 When the motion sensor is used, it is necessary to set Enable or Disable for the "Power control" and the "Auto-off".	A		
5.Filter				
1 Filter sign reset	Filter sign reset	The filter sign can be reset.	A	
	Setting next cleaning date	The next cleaning date can be set.	A	
6.User setting				
1 Internal settings	Clock setting	The current date and time can be set or revised. • If a power failure continues no longer than 80 hours, the clock continues to tick by the built-in power source.	A	△
	Date and time display	[Display] or [Hide] the date and/or time can be set, and [12H] or [24H] display can be set.	A	
	Summer time	When select [Enable], the +1hour adjustment of current time can be set. When select [Disable], the [Summer time] adjustment can be reset.	A	
	Contrast	The contrast of LCD can be adjusted higher or lower.	A	
	Backlight	Switching on/off a light can be set and period of the lighting time can be set within the range of 5sec-90 sec (5sec interval).	A	
	Control sound	It can set with or without [Control sound (beep sound)] at touch panel.	A	
	Operation lamp luminance	*1 This is used to adjust the luminance of operation lamp.	A	
2 Administrator settings [Administrator password]	Permission/Prohibition setting	• Permission/Prohibition setting of operation can be set. [On/Off] [Change set temp] [Change operation mode] [Change flap direction] [Change fan speed] [High power operation] [Energy-saving operation] [Timer] Request for administrator can be set. [Individual flap control] [Weekly timer] [Select the language] [Anti draft setting] *1	A	△
	Outdoor unit silent mode timer	The period of time to operate the outdoor unit by prioritizing the quietness can be set. • The [Start time] and the [End time] for operating outdoor unit in silent mode can be set. • The period of the operation time can be set once a day by 5-minute intervals.	A	△
	Setting temp. range	The upper/lower limit of temp. setting range can be set. • The limitation of indoor temp. setting range can be set for each operation mode in cooling and heating.	A	△

⑤ Operation and setting from remote control (continued)

Setting & display item		Description	RC-EX3A	RC-E5	
2 Administrator settings [Administrator password]	Temp increment setting	The temp increment setting can be changed by 0.5°C or 1.0°C.	A		
	Set temp display	Ways of displaying setting temperatures can be selected.	A		
	R/C display setting	Register [Room name] [Name of I/U] Display [Indoor temp display] or not. Display [Error code display] or not. Display [Heating stand-by display] [Defrost operation display] [Auto cooling/heating display] [Display temp of R/C, Room, Outdoor] or not	A	△	
	Change administrator password	The administrator password can be changed. (Default setting is "0000") The administrator password can be reset.	A B		
	F1/F2 function setting *1	Functions can be set for F1 and F2. Selectable functions: [Anti draft ON/OFF] *2 [High power operation], [Energy-saving operation], [Silent mode cont.], [Home leave mode], [Favorite set 1], [Favorite set 2] and [Filter sign reset].	A		
7. Service setting					
1 Installer settings [Service password]	Installation date	The [Installation date] can be registered. • When registering the [Installation date], the [Next service date] is displayed automatically. (For changing the [Next service date], please refer the item of [Service & Maintenance])	B		
	Company information	The [Company information] can be registered and can be displayed on the R/C. • The [Company] can be registered within 26 characters. • The [Phone No.] can be registered within 13 digits.	B		
	Test run	On/Off operation of the test run can be done.			
		Cooling test run	The [Cooling test run] can be done at 5°C of set temp. for 30 minutes.	B	○
	Drain pump test run	Only drain pump can be operated.			
	Static pressure adjustment	In case of combination with only the ducted indoor unit which has a function of static pressure adjustment, the static pressure is adjustable. • It can be set for each indoor unit individually.	B		
	Change auto-address	The set address of each indoor unit decided by auto-address setting method can be changed to any other address. (For multiple KX units only)	B	△	
	Address setting of main IU	Main indoor unit address can be set. • Only the Main indoor unit can change operation mode and the Sub indoor units dominated by the Main indoor shall follow. • The Main indoor unit can domain 10 indoor units at a maximum.	B	△	
	IU back-up function	When a pair of indoor units (2 groups) is connected to one unit of remote control, it can be set Enable or Disable for the [IU rotation], [IU capacity back-up] and [IU fault back-up]	B		
	Motion sensor setting *1	Set Enable or Disable for the infrared sensor detectors of indoor units connected to the remote control. If Disable is selected, it cannot be control the motion sensor control for the energy-saving setting.	B		
2 R/C function setting [Service password]	Main/Sub R/C	The R/C setting of [Main/Sub] can be changed.	B	○	
	Return air temp	When two or more indoor units are connected to one unit of remote control, suction sensors, which are used for the judgement by thermostat, can be selected. • It can be selected from [Individual], [Master IU] and [Average temp].	B		
	R/C sensor	It can be set the mode to switch to the remote control sensor. It can be selected from cooling and heating.	B	△	
	R/C sensor adjustment	The offset value of [R/C sensor] sensing temp. can be set respectively in heating and cooling.	B	△	
	Operation mode	Enable or Disable can be set for each operation mode.	B	△	
	°C / °F	Set the unit for setting temperatures. • °C or °F can be selected.	B		
	Fan speed	Fan speeds can be selected.	B	○	
	External input	When two or more indoor units are connected to one unit of remote control, the range to apply CNT inputs can be set.	B	○	
	Upper/lower flap control	[Stop at fixed position] or [Stop at any position] can be selected for the upper and lower louvers.	B	○	
	Left/right flap control *1	[Fixed position stop] or [Stop at any position] can be selected for the right and left louvers.	B		
	Ventilation setting	Combination control for ventilator can be set.	B	○	
	Auto-restart	The operation control method after recovery of power failure happened during operation can be set.	B	○	
	Auto temp setting	[Enable] or [Disable] of [Auto temp setting] can be selected.	B		
	Auto fan speed	[Enable] or [Disable] of [Auto fan speed] can be selected.	B		
	3 IU settings [Service password]	Fan speed setting	The fan speed for indoor units can be set.	B	○
Filter sign		The setting of filter sign display timer can be done from following patterns.	B	○	
External input 1		The connect of control by external input 1 can be changed.	B	○	
External input 1 signal		The type of external input 1 signal can be changed.	B	○	
External input 2		The connect of control by external input 2 can be changed.	B		
External input 2 signal		The type of external input 2 signal can be changed.	B		
Heating thermo-OFF temp adjustment		The judgement temp. of heating thermo-off can be adjusted within the range from 0 to +3°C (1°C interval)	B	△	
Return temperature adjustment		The sensing temp. of return air temp. sensor built in the indoor unit can be adjusted within the range of ±2°C.	B	△	
Fan control in cooling thermo-OFF		Fan control, when the cooling thermostat is turned OFF, can be changed.	B	○	
Fan control in heating thermo-OFF		Fan control, when the heating thermostat is turned OFF, can be changed.	B	○	
Anti-frost temp		Judgment temperature for the anti-frost control during cooling can be changed.	B	○	
Anti-frost control		When the anti-frost control of indoor unit in cooling is activated, the fan speed can be changed.	B	○	
Drain pump operation		In any operation mode in addition to cooling and dry mode, the setting of drain pump operation can be done.	B	○	
Keep fan operating after cooling is stopped		The time period residual fan operation after stopping or thermo-off in cooling mode can be set.	B	○	
Keep fan operating after heating is stopped		The time period residual fan operation after stopping or thermo-off in heating mode can be set.	B	○	
Intermittent fan operation in heating		The fan operation rule following the residual fan operation after stopping or thermo-off in heating mode can be set.	B	○	
Fan circulator operation		In case that the fan is operated as the circulator, the fan control rule can be set.	B		
Control pressure adjust		When only the OA processing units are operated, control pressure value can be changed.	B		
Auto operation mode	The [Auto rule selection] for switching the operation mode automatically can be selected from 3 patterns.	B			
Thermo. rule setting	When selecting [Outdoor air temp. control], the judgment temp can be offset by outdoor temp..	B			
Auto fan speed control	Auto switching range for the auto fan speed control can be set.	B			
IU overload alarm	If the difference between the setting temperature and the suction temperature becomes larger than the temperature difference set for the overload alarm, at 30 minutes after the start of operation, the overload alarm signal is transmitted from the external output (CNT-5).	B			
External output setting *1	Functions assigned to the external outputs 1 to 4 can be changed.	B			
4 Service & Maintenance [Service password]	IU address	Max 16 indoor units can be connected to one remote control, and all address No. of the connected indoor units can be displayed. • The indoor unit conforming to the address No. can be identified by selecting the address No. and tapping [Check] to operate the indoor fan.	B	○	
	Next service date	The [Next service date] can be registered. • The [Next service date] and [Company information] is displayed on the message screen.	A B	○	
	Operation data	The [Operation data] for indoor unit and outdoor unit can be displayed.	B	○	
	Error display	Error history	The error history can be displayed.		
		Display anomaly data	The operation data just before the latest error stop can be displayed.	B	△
		Erase anomaly data	Anomaly operation data can be erased.		
		Reset periodical check	The timer for the periodical check can be reset.		
	Saving IU settings	The [IU settings] memorized in the indoor PCB connected to the remote control can be saved in the memory of the remote control.	B		
	Special settings	[Erase IU address] [CPU reset] [Restore of default setting] [Touch panel calibration]	B	△	
	Indoor unit capacity display *1	Address No. and capacities of indoor units connected to the remote control are displayed.	B		
8. Contact company					
9. Inspection					
Confirmation of Inspection		This is displayed when any error occurs.	A	△	
10. PC connection					
USB connection		Weekly timer setting and etc., can be set from PC.	C		

◆ Listed items may not function depending on the specifications of indoor and outdoor units which are combined.

3. PIPING SYSTEM

Model SCM100ZS-W

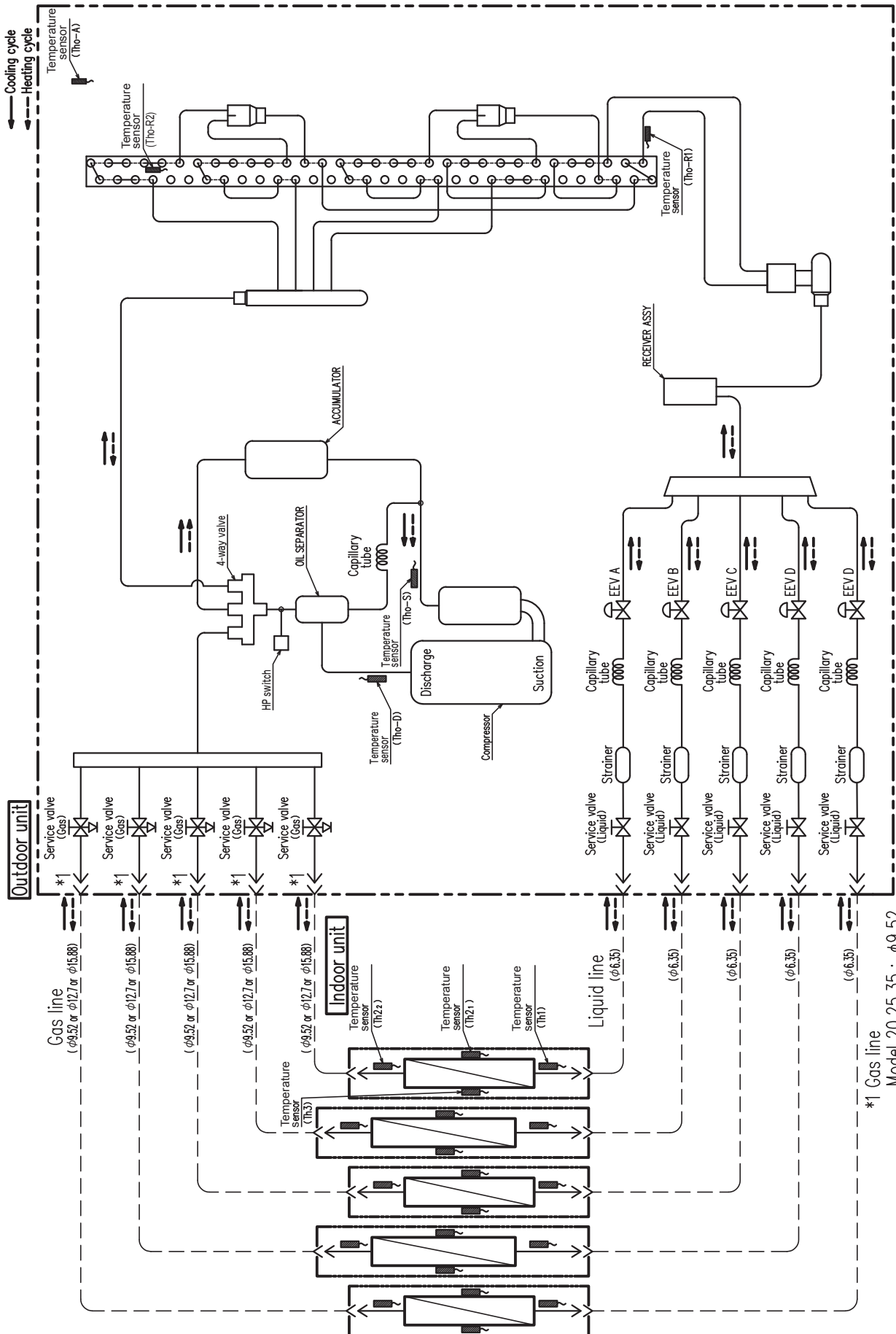

*1 Gas line
 Model 20,25,35 : $\phi 9.52$
 Model 50,60 : $\phi 12.7$
 Model 71,80 : $\phi 15.88$

4. RANGE OF USAGE & LIMITATIONS

Model SCM100

Item		Model	SCM100ZS-W
Indoor intake air temperature (Upper, lower limits)	Cooling		Approximately 18 to 32°C
	Heating		Approximately 15 to 30°C
Outdoor air temperature (Upper, lower limits)	Cooling		Approximately -15 to 46°C
	Heating		Approximately -15 to 24°C
Indoor units that can be used in combination	Number of connected units		2 to 5 units (Include combination limitation ⁽¹⁾)
	Total of indoor units (class kW)		9.0 -16.0kW
Total length for all rooms			Max. 75m
Length for one indoor unit			Max. 25m
Difference in height between indoor and outdoor units	When indoor unit is above outdoor unit (A)		Max. 20m
	When indoor unit is below outdoor unit (B)		Max. 20m
Difference in height between indoor units (C)			Max. 25m
Compressor stop/start frequency	1 cycle time		8 min or more (from stop to stop or from start to start)
	Stop time		3 min or more
Power source voltage	Voltage fluctuation		Within $\pm 10\%$ of rated voltage
	Voltage drop during start		Within $\pm 15\%$ of rated voltage
	Interval unbalance		Within $\pm 3\%$ of rated voltage
Power cable length			32m ⁽²⁾

Notes(1) Regarding to combination limitation, refer to clause 1.5 (2) Combination limitation of connected indoor units.

(2) The cable specifications are based on the assumption that a metal or plastic conduit is used with no more than three cables contained in a conduit and a voltage drop is 2%. For an installation falling outside of these conditions, please follow the internal cabling regulations. Adapt it to the regulation in effect in each country.

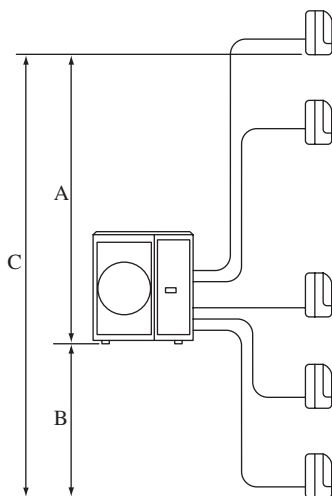

5. TABLE OF INDOOR UNIT COMBINATIONS

- The combinations of the indoor units is indicated by numbers. They are read as follows.
(Example) SRK20ZSX-W→20 SRK25ZSX-W→25
- The capacity of the indoor units is shown by rooms. If this exceeds the maximum capacity of the outdoor unit, the demand capacity will be proportionally distributed.
- If units are to be combined, use the table below to make the proper selection.

• Number of connectable indoor units

SCM100ZS-W	
MIN.	2
MAX.	5

Model SCM100ZS-W

Table of indoor unit combination with all indoor unit

<Cooling>

Indoor unit combination		Cooling capacity (kW)									Power consumption (W)			Standard current (A)			EER
		Room cooling capacity					Total capacity				Min.	Standard	Max.	220V	230V	240V	
		A	B	C	D	E	Min.	Standard	Max.	Standard							
1 room	20	2.0	-	-	-	-	1.7	2.0	2.7	500	530	950	2.5	2.4	2.3	3.77	
	25	2.5	-	-	-	-	1.7	2.5	3.2	500	690	1008	3.3	3.1	3.0	3.62	
	35	3.5	-	-	-	-	1.7	3.5	3.7	500	1010	1340	4.8	4.6	4.4	3.47	
	50	5.0	-	-	-	-	1.7	5.0	5.8	500	1490	1730	6.9	6.6	6.3	3.36	
	60	6.0	-	-	-	-	1.7	6.0	6.7	500	1810	1990	8.3	8.0	7.6	3.31	
	71	7.1	-	-	-	-	1.7	7.1	7.2	500	2170	2270	10.1	9.6	9.2	3.27	
	80	8.0	-	-	-	-	1.7	8.0	8.1	500	2450	2500	11.4	10.9	10.4	3.27	
2 room	20 + 20	2.00	2.00	-	-	-	1.9	4.0	5.8	495	850	1430	4.0	3.8	3.7	4.71	
	20 + 25	2.00	2.50	-	-	-	1.9	4.5	6.1	495	1010	1540	4.7	4.5	4.3	4.46	
	20 + 35	2.00	3.50	-	-	-	1.9	5.5	6.6	495	1330	1720	6.2	5.9	5.7	4.14	
	20 + 50	2.00	5.00	-	-	-	1.9	7.0	7.7	495	1880	2170	8.6	8.2	7.9	3.72	
	20 + 60	2.00	6.00	-	-	-	1.9	8.0	8.8	495	2300	2690	10.7	10.2	9.8	3.48	
	20 + 71	2.00	7.10	-	-	-	1.9	9.1	10.0	495	2850	3420	13.2	12.6	12.1	3.19	
	20 + 80	2.00	8.00	-	-	-	1.9	10.0	10.3	495	3450	3650	16.0	15.3	14.7	2.90	
	25 + 25	2.50	2.50	-	-	-	1.9	5.0	6.5	495	1170	1690	5.4	5.2	5.0	4.27	
	25 + 35	2.50	3.50	-	-	-	1.9	6.0	6.8	495	1600	1800	7.4	7.1	6.8	3.75	
	25 + 50	2.50	5.00	-	-	-	1.9	7.5	8.4	495	2080	2490	9.6	9.2	8.8	3.61	
	25 + 60	2.50	6.00	-	-	-	1.9	8.5	9.4	495	2630	3020	12.2	11.7	11.2	3.23	
	25 + 71	2.50	7.10	-	-	-	1.9	9.6	10.2	495	3140	3570	14.6	13.9	13.4	3.06	
	25 + 80	2.38	7.62	-	-	-	1.9	10.0	10.3	495	3450	3650	16.0	15.3	14.7	2.90	
	35 + 35	3.50	3.50	-	-	-	1.9	7.0	7.7	495	1880	2170	8.6	8.2	7.9	3.72	
	35 + 50	3.50	5.00	-	-	-	1.9	8.5	9.4	495	2630	3020	12.2	11.7	11.2	3.23	
	35 + 60	3.50	6.00	-	-	-	1.9	9.5	10.2	495	3080	3570	14.3	13.7	13.1	3.08	
	35 + 71	3.30	6.70	-	-	-	1.9	10.0	10.3	495	3450	3650	16.0	15.3	14.7	2.90	
	35 + 80	3.04	6.96	-	-	-	1.9	10.0	10.3	495	3450	3650	16.0	15.3	14.7	2.90	
	50 + 50	5.00	5.00	-	-	-	1.9	10.0	10.3	495	3450	3650	16.0	15.3	14.7	2.90	
	50 + 60	4.55	5.45	-	-	-	1.9	10.0	10.3	495	3450	3650	16.0	15.3	14.7	2.90	
50 + 71	4.13	5.87	-	-	-	1.9	10.0	10.3	495	3450	3650	16.0	15.3	14.7	2.90		
50 + 80	3.85	6.15	-	-	-	1.9	10.0	10.3	495	3450	3650	16.0	15.3	14.7	2.90		
60 + 60	5.00	5.00	-	-	-	1.9	10.0	10.3	495	3450	3650	16.0	15.3	14.7	2.90		
60 + 71	4.58	5.42	-	-	-	1.9	10.0	10.3	495	3450	3650	16.0	15.3	14.7	2.90		
60 + 80	4.29	5.71	-	-	-	1.9	10.0	10.3	495	3450	3650	16.0	15.3	14.7	2.90		
71 + 71	5.00	5.00	-	-	-	1.9	10.0	10.3	495	3450	3650	16.0	15.3	14.7	2.90		
71 + 80	4.70	5.30	-	-	-	1.9	10.0	10.3	495	3450	3650	16.0	15.3	14.7	2.90		
80 + 80	5.00	5.00	-	-	-	1.9	10.0	10.3	495	3450	3650	16.0	15.3	14.7	2.90		
3 room	20 + 20 + 20	2.00	2.00	2.00	-	-	2.1	6.0	7.4	490	1430	1930	6.6	6.3	6.1	4.20	
	20 + 20 + 25	2.00	2.00	2.50	-	-	2.1	6.5	7.7	490	1600	2050	7.4	7.1	6.8	4.06	
	20 + 20 + 35	2.00	2.00	3.50	-	-	2.1	7.5	8.6	490	1970	2430	9.1	8.7	8.4	3.81	
	20 + 20 + 50	2.00	2.00	5.00	-	-	2.1	9.0	9.6	490	2610	2920	12.1	11.6	11.1	3.45	
	20 + 20 + 60	2.00	2.00	6.00	-	-	2.1	10.0	10.7	490	3230	3650	15.0	14.3	13.7	3.10	
	20 + 20 + 71	1.80	1.80	6.40	-	-	2.1	10.0	10.7	490	3230	3650	15.0	14.3	13.7	3.10	
	20 + 20 + 80	1.67	1.67	6.67	-	-	2.1	10.0	10.7	490	3230	3650	15.0	14.3	13.7	3.10	

<Cooling>

Indoor unit combination	Cooling capacity (kW)									Power consumption (W)			Standard current (A)			EER
	Room cooling capacity					Total capacity				Min.	Standard	Max.	220V	230V	240V	
	A	B	C	D	E	Min.	Standard	Max.								
3 room	20 + 25 + 25	2.00	2.50	2.50	-	-	2.1	7.0	8.0	490	1780	2170	8.2	7.8	7.5	3.93
	20 + 25 + 35	2.00	2.50	3.50	-	-	2.1	8.0	9.0	490	2170	2160	10.1	9.6	9.2	3.69
	20 + 25 + 50	2.00	2.50	5.00	-	-	2.1	9.5	10.3	490	2870	3340	13.3	12.7	12.2	3.31
	20 + 25 + 60	1.90	2.38	5.71	-	-	2.1	10.0	10.7	490	3230	3650	15.0	14.3	13.7	3.10
	20 + 35 + 35	2.00	3.50	3.50	-	-	2.1	9.0	9.6	490	2610	2920	12.1	11.6	11.1	3.45
	20 + 35 + 50	1.90	3.33	4.76	-	-	2.1	10.0	10.7	490	3230	3650	15.0	14.3	13.7	3.10
	20 + 35 + 60	1.74	3.04	5.22	-	-	2.1	10.0	10.7	490	3230	3650	15.0	14.3	13.7	3.10
	20 + 35 + 71	1.59	2.78	5.63	-	-	2.1	10.0	10.7	490	3230	3650	15.0	14.3	13.7	3.10
	20 + 35 + 80	1.48	2.59	5.93	-	-	2.1	10.0	10.7	490	3230	3650	15.0	14.3	13.7	3.10
	20 + 50 + 50	1.67	4.17	4.17	-	-	2.1	10.0	10.7	490	3230	3650	15.0	14.3	13.7	3.10
	20 + 50 + 60	1.54	3.85	4.62	-	-	2.1	10.0	10.7	490	3230	3650	15.0	14.3	13.7	3.10
	20 + 50 + 71	1.42	3.55	5.04	-	-	2.1	10.0	10.7	490	3230	3650	15.0	14.3	13.7	3.10
	20 + 50 + 80	1.33	3.33	5.33	-	-	2.1	10.0	10.7	490	3230	3650	15.0	14.3	13.7	3.10
	20 + 60 + 60	1.43	4.29	4.29	-	-	2.1	10.0	10.7	490	3230	3650	15.0	14.3	13.7	3.10
	20 + 60 + 71	1.32	3.97	4.70	-	-	2.1	10.0	10.7	490	3230	3650	15.0	14.3	13.7	3.10
	20 + 60 + 80	1.25	3.75	5.00	-	-	2.1	10.0	10.7	490	3230	3650	15.0	14.3	13.7	3.10
	25 + 25 + 25	2.50	2.50	2.50	-	-	2.1	7.5	8.6	490	1970	2430	9.1	8.7	8.4	3.81
	25 + 25 + 35	2.50	2.50	3.50	-	-	2.1	8.5	9.2	490	2380	2710	11.0	10.6	10.1	3.57
	25 + 25 + 50	2.50	2.50	5.00	-	-	2.1	10.0	10.7	490	3230	3650	15.0	14.3	13.7	3.10
	25 + 25 + 60	2.27	2.27	5.45	-	-	2.1	10.0	10.7	490	3230	3650	15.0	14.3	13.7	3.10
	25 + 25 + 71	2.07	2.07	5.87	-	-	2.1	10.0	10.7	490	3230	3650	15.0	14.3	13.7	3.10
	25 + 25 + 80	1.92	1.92	6.15	-	-	2.1	10.0	10.7	490	3230	3650	15.0	14.3	13.7	3.10
	25 + 35 + 35	2.50	3.50	3.50	-	-	2.1	9.5	10.3	490	2870	3340	13.3	12.7	12.2	3.31
	25 + 35 + 50	2.27	3.18	4.55	-	-	2.1	10.0	10.7	490	3230	3650	15.0	14.3	13.7	3.10
	25 + 35 + 60	2.08	2.92	5.00	-	-	2.1	10.0	10.7	490	3230	3650	15.0	14.3	13.7	3.10
	25 + 35 + 71	1.91	2.67	5.42	-	-	2.1	10.0	10.7	490	3230	3650	15.0	14.3	13.7	3.10
	25 + 35 + 80	1.79	2.50	5.71	-	-	2.1	10.0	10.7	490	3230	3650	15.0	14.3	13.7	3.10
	25 + 50 + 50	2.00	4.00	4.00	-	-	2.1	10.0	10.7	490	3230	3650	15.0	14.3	13.7	3.10
	25 + 50 + 60	1.85	3.70	4.44	-	-	2.1	10.0	10.7	490	3230	3650	15.0	14.3	13.7	3.10
	25 + 50 + 71	1.71	3.42	4.86	-	-	2.1	10.0	10.7	490	3230	3650	15.0	14.3	13.7	3.10
	25 + 50 + 80	1.61	3.23	5.16	-	-	2.1	10.0	10.7	490	3230	3650	15.0	14.3	13.7	3.10
	25 + 60 + 60	1.72	4.14	4.14	-	-	2.1	10.0	10.7	490	3230	3650	15.0	14.3	13.7	3.10
	25 + 60 + 71	1.60	3.85	4.55	-	-	2.1	10.0	10.7	490	3230	3650	15.0	14.3	13.7	3.10
	35 + 35 + 35	3.33	3.33	3.33	-	-	2.1	10.0	10.7	490	3230	3650	15.0	14.3	13.7	3.10
	35 + 35 + 50	2.92	2.92	4.17	-	-	2.1	10.0	10.7	490	3230	3650	15.0	14.3	13.7	3.10
	35 + 35 + 60	2.69	2.69	4.62	-	-	2.1	10.0	10.7	490	3230	3650	15.0	14.3	13.7	3.10
35 + 35 + 71	2.48	2.48	5.04	-	-	2.1	10.0	10.7	490	3230	3650	15.0	14.3	13.7	3.10	
35 + 35 + 80	2.33	2.33	5.33	-	-	2.1	10.0	10.7	490	3230	3650	15.0	14.3	13.7	3.10	
35 + 50 + 50	2.59	3.70	3.70	-	-	2.1	10.0	10.7	490	3230	3650	15.0	14.3	13.7	3.10	
35 + 50 + 60	2.41	3.45	4.14	-	-	2.1	10.0	10.7	490	3230	3650	15.0	14.3	13.7	3.10	
35 + 50 + 71	2.24	3.21	4.55	-	-	2.1	10.0	10.7	490	3230	3650	15.0	14.3	13.7	3.10	
35 + 60 + 60	2.26	3.87	3.87	-	-	2.1	10.0	10.7	490	3230	3650	15.0	14.3	13.7	3.10	
50 + 50 + 50	3.33	3.33	3.33	-	-	2.1	10.0	10.7	490	3230	3650	15.0	14.3	13.7	3.10	
50 + 50 + 60	3.13	3.13	3.75	-	-	2.1	10.0	10.7	490	3230	3650	15.0	14.3	13.7	3.10	
4 room	20 + 20 + 20 + 20	2.00	2.00	2.00	2.00	-	2.3	8.0	8.8	485	2020	2330	9.4	9.0	8.6	3.96
	20 + 20 + 20 + 25	2.00	2.00	2.00	2.50	-	2.3	8.5	9.4	485	2210	2590	10.3	9.8	9.4	3.85
	20 + 20 + 20 + 35	2.00	2.00	2.00	3.50	-	2.3	9.5	10.5	485	2640	3150	12.2	11.7	11.2	3.60
	20 + 20 + 20 + 50	1.82	1.82	1.82	4.55	-	2.3	10.0	11.3	485	2950	3650	13.7	13.1	12.5	3.40
	20 + 20 + 20 + 60	1.67	1.67	1.67	5.00	-	2.3	10.0	11.3	485	2950	3650	13.7	13.1	12.5	3.40
	20 + 20 + 20 + 71	1.53	1.53	1.53	5.42	-	2.3	10.0	11.3	485	2950	3650	13.7	13.1	12.5	3.40
	20 + 20 + 20 + 80	1.43	1.43	1.43	5.71	-	2.3	10.0	11.3	485	2950	3650	13.7	13.1	12.5	3.40
	20 + 20 + 25 + 25	2.00	2.00	2.50	2.50	-	2.3	9.0	9.9	485	2420	2830	11.2	10.7	10.3	3.72
	20 + 20 + 25 + 35	2.00	2.00	2.50	3.50	-	2.3	10.0	11.3	485	2950	3650	13.7	13.1	12.5	3.40
	20 + 20 + 25 + 50	1.74	1.74	2.17	4.35	-	2.3	10.0	11.3	485	2950	3650	13.7	13.1	12.5	3.40
	20 + 20 + 25 + 60	1.60	1.60	2.00	4.80	-	2.3	10.0	11.3	485	2950	3650	13.7	13.1	12.5	3.40

<Cooling>

Indoor unit combination		Cooling capacity (kW)									Power consumption (W)			Standard current (A)			EER
		Room cooling capacity					Total capacity				Min.	Standard	Max.	220V	230V	240V	
		A	B	C	D	E	Min.	Standard	Max.	Standard							
4 room	20 + 20 + 25 + 71	1.47	1.47	1.84	5.22	-	2.3	10.0	11.3	485	2950	3650	13.7	13.1	12.5	3.40	
	20 + 20 + 25 + 80	1.38	1.38	1.72	5.52	-	2.3	10.0	11.3	485	2950	3650	13.7	13.1	12.5	3.40	
	20 + 20 + 35 + 35	1.82	1.82	3.18	3.18	-	2.3	10.0	11.3	485	2950	3650	13.7	13.1	12.5	3.40	
	20 + 20 + 35 + 50	1.60	1.60	2.80	4.00	-	2.3	10.0	11.3	485	2950	3650	13.7	13.1	12.5	3.40	
	20 + 20 + 35 + 60	1.48	1.48	2.59	4.44	-	2.3	10.0	11.3	485	2950	3650	13.7	13.1	12.5	3.40	
	20 + 20 + 35 + 71	1.37	1.37	2.40	4.86	-	2.3	10.0	11.3	485	2950	3650	13.7	13.1	12.5	3.40	
	20 + 20 + 35 + 80	1.29	1.29	2.26	5.16	-	2.3	10.0	11.3	485	2950	3650	13.7	13.1	12.5	3.40	
	20 + 20 + 50 + 50	1.43	1.43	3.57	3.57	-	2.3	10.0	11.3	485	2950	3650	13.7	13.1	12.5	3.40	
	20 + 20 + 50 + 60	1.33	1.33	3.33	4.00	-	2.3	10.0	11.3	485	2950	3650	13.7	13.1	12.5	3.40	
	20 + 20 + 60 + 60	1.25	1.25	3.75	3.75	-	2.3	10.0	11.3	485	2950	3650	13.7	13.1	12.5	3.40	
	20 + 25 + 25 + 25	2.00	2.50	2.50	2.50	-	2.3	9.5	10.5	485	2640	3150	12.2	11.7	11.2	3.60	
	20 + 25 + 25 + 35	1.90	2.38	2.38	3.33	-	2.3	10.0	11.1	485	2950	3650	13.7	13.1	12.5	3.40	
	20 + 25 + 25 + 50	1.67	2.08	2.08	4.17	-	2.3	10.0	11.1	485	2950	3650	13.7	13.1	12.5	3.40	
	20 + 25 + 25 + 60	1.54	1.92	1.92	4.62	-	2.3	10.0	11.1	485	2950	3650	13.7	13.1	12.5	3.40	
	20 + 25 + 25 + 71	1.42	1.77	1.77	5.04	-	2.3	10.0	11.1	485	2950	3650	13.7	13.1	12.5	3.40	
	20 + 25 + 25 + 80	1.33	1.67	1.67	5.33	-	2.3	10.0	11.1	485	2950	3650	13.7	13.1	12.5	3.40	
	20 + 25 + 35 + 35	1.74	2.17	3.04	3.04	-	2.3	10.0	11.1	485	2950	3650	13.7	13.1	12.5	3.40	
	20 + 25 + 35 + 50	1.54	1.92	2.69	3.85	-	2.3	10.0	11.1	485	2950	3650	13.7	13.1	12.5	3.40	
	20 + 25 + 35 + 60	1.43	1.79	2.50	4.29	-	2.3	10.0	11.1	485	2950	3650	13.7	13.1	12.5	3.40	
	20 + 25 + 35 + 71	1.32	1.66	2.32	4.70	-	2.3	10.0	11.1	485	2950	3650	13.7	13.1	12.5	3.40	
	20 + 25 + 35 + 80	1.25	1.56	2.19	5.00	-	2.3	10.0	11.1	485	2950	3650	13.7	13.1	12.5	3.40	
	20 + 25 + 50 + 50	1.38	1.72	3.45	3.45	-	2.3	10.0	11.1	485	2950	3650	13.7	13.1	12.5	3.40	
	20 + 25 + 50 + 60	1.29	1.61	3.23	3.87	-	2.3	10.0	11.1	485	2950	3650	13.7	13.1	12.5	3.40	
	20 + 35 + 35 + 35	1.60	2.80	2.80	2.80	-	2.3	10.0	11.1	485	2950	3650	13.7	13.1	12.5	3.40	
	20 + 35 + 35 + 50	1.43	2.50	2.50	3.57	-	2.3	10.0	11.1	485	2950	3650	13.7	13.1	12.5	3.40	
	20 + 35 + 35 + 60	1.33	2.33	2.33	4.00	-	2.3	10.0	11.1	485	2950	3650	13.7	13.1	12.5	3.40	
	20 + 35 + 50 + 50	1.29	2.26	3.23	3.23	-	2.3	10.0	11.1	485	2950	3650	13.7	13.1	12.5	3.40	
	25 + 25 + 25 + 25	2.50	2.50	2.50	2.50	-	2.3	10.0	11.1	485	2950	3650	13.7	13.1	12.5	3.40	
	25 + 25 + 25 + 35	2.27	2.27	2.27	3.18	-	2.3	10.0	11.1	485	2950	3650	13.7	13.1	12.5	3.40	
	25 + 25 + 25 + 50	2.00	2.00	2.00	4.00	-	2.3	10.0	11.1	485	2950	3650	13.7	13.1	12.5	3.40	
	25 + 25 + 25 + 60	1.85	1.85	1.85	4.44	-	2.3	10.0	11.1	485	2950	3650	13.7	13.1	12.5	3.40	
	25 + 25 + 25 + 71	1.71	1.71	1.71	4.86	-	2.3	10.0	11.1	485	2950	3650	13.7	13.1	12.5	3.40	
	25 + 25 + 25 + 80	1.61	1.61	1.61	5.16	-	2.3	10.0	11.1	485	2950	3650	13.7	13.1	12.5	3.40	
	25 + 25 + 35 + 35	2.08	2.08	2.92	2.92	-	2.3	10.0	11.1	485	2950	3650	13.7	13.1	12.5	3.40	
25 + 25 + 35 + 50	1.85	1.85	2.59	3.70	-	2.3	10.0	11.1	485	2950	3650	13.7	13.1	12.5	3.40		
25 + 25 + 35 + 60	1.72	1.72	2.41	4.14	-	2.3	10.0	11.1	485	2950	3650	13.7	13.1	12.5	3.40		
25 + 25 + 35 + 71	1.60	1.60	2.24	4.55	-	2.3	10.0	11.1	485	2950	3650	13.7	13.1	12.5	3.40		
25 + 25 + 50 + 50	1.67	1.67	3.33	3.33	-	2.3	10.0	11.1	485	2950	3650	13.7	13.1	12.5	3.40		
25 + 25 + 50 + 60	1.56	1.56	3.13	3.75	-	2.3	10.0	11.1	485	2950	3650	13.7	13.1	12.5	3.40		
25 + 35 + 35 + 35	1.92	2.69	2.69	2.69	-	2.3	10.0	11.1	485	2950	3650	13.7	13.1	12.5	3.40		
25 + 35 + 35 + 50	1.72	2.41	2.41	3.45	-	2.3	10.0	11.1	485	2950	3650	13.7	13.1	12.5	3.40		
25 + 35 + 35 + 60	1.61	2.26	2.26	3.87	-	2.3	10.0	11.1	485	2950	3650	13.7	13.1	12.5	3.40		
25 + 35 + 50 + 50	1.56	2.19	3.13	3.13	-	2.3	10.0	11.1	485	2950	3650	13.7	13.1	12.5	3.40		
35 + 35 + 35 + 35	2.50	2.50	2.50	2.50	-	2.3	10.0	11.1	485	2950	3650	13.7	13.1	12.5	3.40		
35 + 35 + 35 + 50	2.26	2.26	2.26	3.23	-	2.3	10.0	11.1	485	2950	3650	13.7	13.1	12.5	3.40		
5 room	20 + 20 + 20 + 20 + 20	2.00	2.00	2.00	2.00	2.00	2.5	10.0	11.5	480	2700	3650	12.4	11.9	11.4	3.70	
	20 + 20 + 20 + 20 + 25	1.90	1.90	1.90	1.90	2.38	2.5	10.0	11.5	480	2700	3650	12.4	11.9	11.4	3.70	
	20 + 20 + 20 + 20 + 35	1.74	1.74	1.74	1.74	3.04	2.5	10.0	11.5	480	2700	3650	12.4	11.9	11.4	3.70	
	20 + 20 + 20 + 20 + 50	1.54	1.54	1.54	1.54	3.85	2.5	10.0	11.5	480	2700	3650	12.4	11.9	11.4	3.70	
	20 + 20 + 20 + 20 + 60	1.43	1.43	1.43	1.43	4.29	2.5	10.0	11.5	480	2700	3650	12.4	11.9	11.4	3.70	
	20 + 20 + 20 + 25 + 25	1.82	1.82	1.82	2.27	2.27	2.5	10.0	11.5	480	2700	3650	12.4	11.9	11.4	3.70	
	20 + 20 + 20 + 25 + 35	1.67	1.67	1.67	2.08	2.92	2.5	10.0	11.5	480	2700	3650	12.4	11.9	11.4	3.70	
	20 + 20 + 20 + 25 + 50	1.48	1.48	1.48	1.85	3.70	2.5	10.0	11.5	480	2700	3650	12.4	11.9	11.4	3.70	
	20 + 20 + 20 + 25 + 60	1.38	1.38	1.38	1.72	4.14	2.5	10.0	11.5	480	2700	3650	12.4	11.9	11.4	3.70	
20 + 20 + 20 + 35 + 35	1.54	1.54	1.54	2.69	2.69	2.5	10.0	11.5	480	2700	3650	12.4	11.9	11.4	3.70		

<Cooling>

Indoor unit combination		Cooling capacity (kW)									Power consumption (W)			Standard current (A)			EER
		Room cooling capacity					Total capacity				Min.	Standard	Max.	220V	230V	240V	Standard
		A	B	C	D	E	Min.	Standard	Max.								
5 room	20 + 20 + 20 + 35 + 50	1.38	1.38	1.38	2.41	3.45	2.5	10.0	11.5	480	2700	3650	12.4	11.9	11.4	3.70	
	20 + 20 + 20 + 35 + 60	1.29	1.29	1.29	2.26	3.87	2.5	10.0	11.5	480	2700	3650	12.4	11.9	11.4	3.70	
	20 + 20 + 25 + 25 + 25	1.74	1.74	2.17	2.17	2.17	2.5	10.0	11.5	480	2700	3650	12.4	11.9	11.4	3.70	
	20 + 20 + 25 + 25 + 35	1.60	1.60	2.00	2.00	2.80	2.5	10.0	11.5	480	2700	3650	12.4	11.9	11.4	3.70	
	20 + 20 + 25 + 25 + 50	1.43	1.43	1.79	1.79	3.57	2.5	10.0	11.5	480	2700	3650	12.4	11.9	11.4	3.70	
	20 + 20 + 25 + 25 + 60	1.33	1.33	1.67	1.67	4.00	2.5	10.0	11.5	480	2700	3650	12.4	11.9	11.4	3.70	
	20 + 20 + 25 + 35 + 35	1.48	1.48	1.85	2.59	2.59	2.5	10.0	11.5	480	2700	3650	12.4	11.9	11.4	3.70	
	20 + 20 + 25 + 35 + 50	1.33	1.33	1.67	2.33	3.33	2.5	10.0	11.5	480	2700	3650	12.4	11.9	11.4	3.70	
	20 + 20 + 25 + 35 + 60	1.25	1.25	1.56	2.19	3.75	2.5	10.0	11.5	480	2700	3650	12.4	11.9	11.4	3.70	
	20 + 20 + 35 + 35 + 35	1.38	1.38	2.41	2.41	2.41	2.5	10.0	11.5	480	2700	3650	12.4	11.9	11.4	3.70	
	20 + 20 + 35 + 35 + 50	1.25	1.25	2.19	2.19	3.13	2.5	10.0	11.5	480	2700	3650	12.4	11.9	11.4	3.70	
	20 + 25 + 25 + 25 + 25	1.67	2.08	2.08	2.08	2.08	2.5	10.0	11.5	480	2700	3650	12.4	11.9	11.4	3.70	
	20 + 25 + 25 + 25 + 35	1.54	1.92	1.92	1.92	2.69	2.5	10.0	11.5	480	2700	3650	12.4	11.9	11.4	3.70	
	20 + 25 + 25 + 25 + 50	1.38	1.72	1.72	1.72	3.45	2.5	10.0	11.5	480	2700	3650	12.4	11.9	11.4	3.70	
	20 + 25 + 25 + 25 + 60	1.29	1.61	1.61	1.61	3.87	2.5	10.0	11.5	480	2700	3650	12.4	11.9	11.4	3.70	
	20 + 25 + 25 + 35 + 35	1.43	1.79	1.79	2.50	2.50	2.5	10.0	11.5	480	2700	3650	12.4	11.9	11.4	3.70	
	20 + 25 + 25 + 35 + 50	1.29	1.61	1.61	2.26	3.23	2.5	10.0	11.5	480	2700	3650	12.4	11.9	11.4	3.70	
	20 + 25 + 35 + 35 + 35	1.33	1.67	2.33	2.33	2.33	2.5	10.0	11.5	480	2700	3650	12.4	11.9	11.4	3.70	
	20 + 35 + 35 + 35 + 35	1.25	2.19	2.19	2.19	2.19	2.5	10.0	11.5	480	2700	3650	12.4	11.9	11.4	3.70	
	25 + 25 + 25 + 25 + 25	2.00	2.00	2.00	2.00	2.00	2.5	10.0	11.5	480	2700	3650	12.4	11.9	11.4	3.70	
25 + 25 + 25 + 25 + 35	1.85	1.85	1.85	1.85	2.59	2.5	10.0	11.5	480	2700	3650	12.4	11.9	11.4	3.70		
25 + 25 + 25 + 25 + 50	1.67	1.67	1.67	1.67	3.33	2.5	10.0	11.5	480	2700	3650	12.4	11.9	11.4	3.70		
25 + 25 + 25 + 25 + 60	1.56	1.56	1.56	1.56	3.75	2.5	10.0	11.5	480	2700	3650	12.4	11.9	11.4	3.70		
25 + 25 + 25 + 35 + 35	1.72	1.72	1.72	2.41	2.41	2.5	10.0	11.5	480	2700	3650	12.4	11.9	11.4	3.70		
25 + 25 + 25 + 35 + 50	1.56	1.56	1.56	2.19	3.13	2.5	10.0	11.5	480	2700	3650	12.4	11.9	11.4	3.70		
25 + 25 + 35 + 35 + 35	1.61	1.61	2.26	2.26	2.26	2.5	10.0	11.5	480	2700	3650	12.4	11.9	11.4	3.70		

<Heating>

Indoor unit combination		Heating capacity (kW)									Power consumption (W)			Standard current (A)			COP
		Room heating capacity					Total capacity				Min.	Standard	Max.	220V	230V	240V	
		A	B	C	D	E	Min.	Standard	Max.								
1 room	20	3.0	-	-	-	-	0.9	3.0	3.5	490	1060	1330	5.1	4.8	4.6	2.83	
	25	3.4	-	-	-	-	0.9	3.4	4.0	490	1140	1400	5.4	5.2	5.0	2.98	
	35	4.5	-	-	-	-	0.9	4.5	4.8	490	1350	1570	6.3	6.1	5.8	3.33	
	50	5.8	-	-	-	-	0.9	5.8	6.2	490	1610	1770	7.4	7.1	6.8	3.60	
	60	6.8	-	-	-	-	0.9	6.8	7.1	490	1800	1920	8.3	7.9	7.6	3.78	
	71	8.0	-	-	-	-	0.9	8.0	8.1	490	2030	2110	9.3	8.9	8.5	3.94	
	80	9.0	-	-	-	-	0.9	9.0	9.1	490	2220	2260	10.2	9.7	9.3	4.05	
2 room	20 + 20	2.70	2.70	-	-	-	1.2	5.4	7.0	460	1170	1610	5.5	5.2	5.0	4.62	
	20 + 25	2.62	3.28	-	-	-	1.2	5.9	7.3	460	1310	1690	6.0	5.8	5.5	4.50	
	20 + 35	2.51	4.39	-	-	-	1.2	6.9	7.9	460	1580	1860	7.3	6.9	6.6	4.37	
	20 + 50	2.51	6.29	-	-	-	1.2	8.8	9.2	460	2130	2240	9.8	9.4	9.0	4.13	
	20 + 60	2.45	7.35	-	-	-	1.2	9.8	10.3	460	2430	2580	11.2	10.7	10.2	4.03	
	20 + 71	2.31	8.19	-	-	-	1.2	10.5	11.2	460	2620	2900	12.0	11.5	11.0	4.00	
	20 + 80	2.10	8.40	-	-	-	1.2	10.5	11.2	460	2620	2900	12.0	11.5	11.0	4.00	
	25 + 25	3.20	3.20	-	-	-	1.2	6.4	7.7	460	1440	1810	6.6	6.3	6.1	4.44	
	25 + 35	3.25	4.55	-	-	-	1.2	7.8	8.2	460	1830	1950	8.4	8.0	7.7	4.26	
	25 + 50	3.07	6.13	-	-	-	1.2	9.2	9.6	460	2240	2370	10.3	9.8	9.4	4.11	
	25 + 60	3.00	7.20	-	-	-	1.2	10.2	10.7	460	2550	2710	11.7	11.2	10.7	4.00	
	25 + 71	2.73	7.77	-	-	-	1.2	10.5	11.2	460	2620	2900	12.0	11.5	11.0	4.00	
	25 + 80	2.50	8.00	-	-	-	1.2	10.5	11.2	460	2620	2900	12.0	11.5	11.0	4.00	
	35 + 35	4.50	4.50	-	-	-	1.2	9.0	9.4	460	2180	2310	10.0	9.6	9.2	4.13	
	35 + 50	4.24	6.06	-	-	-	1.2	10.3	10.8	460	2560	2740	11.8	11.2	10.8	4.02	
	35 + 60	3.87	6.63	-	-	-	1.2	10.5	11.2	460	2620	2900	12.0	11.5	11.0	4.00	
	35 + 71	3.47	7.03	-	-	-	1.2	10.5	11.2	460	2620	2900	12.0	11.5	11.0	4.00	
	35 + 80	3.20	7.30	-	-	-	1.2	10.5	11.2	460	2620	2900	12.0	11.5	11.0	4.00	
	50 + 50	5.25	5.25	-	-	-	1.2	10.5	11.2	460	2620	2900	12.0	11.5	11.0	4.00	
	50 + 60	4.77	5.73	-	-	-	1.2	10.5	11.2	460	2620	2900	12.0	11.5	11.0	4.00	
	50 + 71	4.34	6.16	-	-	-	1.2	10.5	11.2	460	2620	2900	12.0	11.5	11.0	4.00	
	50 + 80	4.04	6.46	-	-	-	1.2	10.5	11.2	460	2620	2900	12.0	11.5	11.0	4.00	
60 + 60	5.25	5.25	-	-	-	1.2	10.5	11.2	460	2620	2900	12.0	11.5	11.0	4.00		
60 + 71	4.81	5.69	-	-	-	1.2	10.5	11.2	460	2620	2900	12.0	11.5	11.0	4.00		
60 + 80	4.50	6.00	-	-	-	1.2	10.5	11.2	460	2620	2900	12.0	11.5	11.0	4.00		
71 + 71	5.25	5.25	-	-	-	1.2	10.5	11.2	460	2620	2900	12.0	11.5	11.0	4.00		
71 + 80	4.94	5.56	-	-	-	1.2	10.5	11.2	460	2620	2900	12.0	11.5	11.0	4.00		
80 + 80	5.25	5.25	-	-	-	1.2	10.5	11.2	460	2620	2900	12.0	11.5	11.0	4.00		
3 room	20 + 20 + 20	3.00	3.00	3.00	-	-	1.4	9.0	9.6	430	2140	2320	9.8	9.4	9.0	4.21	
	20 + 20 + 25	2.89	2.89	3.62	-	-	1.4	9.4	10.0	430	2260	2440	10.4	9.9	9.5	4.16	
	20 + 20 + 35	2.80	2.80	4.90	-	-	1.4	10.5	11.3	430	2540	2900	11.7	11.2	10.7	4.13	
	20 + 20 + 50	2.33	2.33	5.83	-	-	1.4	10.5	11.3	430	2540	2900	11.7	11.2	10.7	4.13	
	20 + 20 + 60	2.10	2.10	6.30	-	-	1.4	10.5	11.3	430	2540	2900	11.7	11.2	10.7	4.13	
	20 + 20 + 71	1.89	1.89	6.72	-	-	1.4	10.5	11.3	430	2540	2900	11.7	11.2	10.7	4.13	
	20 + 20 + 80	1.75	1.75	7.00	-	-	1.4	10.5	11.3	430	2540	2900	11.7	11.2	10.7	4.13	
	20 + 25 + 25	3.00	3.75	3.75	-	-	1.4	10.5	11.3	430	2540	2900	11.7	11.2	10.7	4.13	
	20 + 25 + 35	2.63	3.28	4.59	-	-	1.4	10.5	11.3	430	2540	2900	11.7	11.2	10.7	4.13	
	20 + 25 + 50	2.21	2.76	5.53	-	-	1.4	10.5	11.3	430	2540	2900	11.7	11.2	10.7	4.13	
	20 + 25 + 60	2.00	2.50	6.00	-	-	1.4	10.5	11.3	430	2540	2900	11.7	11.2	10.7	4.13	
	20 + 35 + 35	2.33	4.08	4.08	-	-	1.4	10.5	11.3	430	2540	2900	11.7	11.2	10.7	4.13	
	20 + 35 + 50	2.00	3.50	5.00	-	-	1.4	10.5	11.3	430	2540	2900	11.7	11.2	10.7	4.13	
	20 + 35 + 60	1.83	3.20	5.48	-	-	1.4	10.5	11.3	430	2540	2900	11.7	11.2	10.7	4.13	
	20 + 35 + 71	1.67	2.92	5.92	-	-	1.4	10.5	11.3	430	2540	2900	11.7	11.2	10.7	4.13	
	20 + 35 + 80	1.56	2.72	6.22	-	-	1.4	10.5	11.3	430	2540	2900	11.7	11.2	10.7	4.13	
	20 + 50 + 50	1.75	4.38	4.38	-	-	1.4	10.5	11.3	430	2540	2900	11.7	11.2	10.7	4.13	
	20 + 50 + 60	1.62	4.04	4.85	-	-	1.4	10.5	11.3	430	2540	2900	11.7	11.2	10.7	4.13	
20 + 50 + 71	1.49	3.72	5.29	-	-	1.4	10.5	11.3	430	2540	2900	11.7	11.2	10.7	4.13		
20 + 50 + 80	1.40	3.50	5.60	-	-	1.4	10.5	11.3	430	2540	2900	11.7	11.2	10.7	4.13		

<Heating>

Indoor unit combination	Heating capacity (kW)									Power consumption (W)			Standard current (A)			COP
	Room heating capacity					Total capacity				Min.	Standard	Max.	220V	230V	240V	
	A	B	C	D	E	Min.	Standard	Max.	Standard							
3 room	20 + 60 + 60	1.50	4.50	4.50	-	-	1.4	10.5	11.3	430	2540	2900	11.7	11.2	10.7	4.13
	20 + 60 + 71	1.39	4.17	4.94	-	-	1.4	10.5	11.3	430	2540	2900	11.7	11.2	10.7	4.13
	20 + 60 + 80	1.31	3.94	5.25	-	-	1.4	10.5	11.3	430	2540	2900	11.7	11.2	10.7	4.13
	25 + 25 + 25	3.50	3.50	3.50	-	-	1.4	10.5	11.3	430	2540	2900	11.7	11.2	10.7	4.13
	25 + 25 + 35	3.09	3.09	4.32	-	-	1.4	10.5	11.3	430	2540	2900	11.7	11.2	10.7	4.13
	25 + 25 + 50	2.63	2.63	5.25	-	-	1.4	10.5	11.3	430	2540	2900	11.7	11.2	10.7	4.13
	25 + 25 + 60	2.39	2.39	5.73	-	-	1.4	10.5	11.3	430	2540	2900	11.7	11.2	10.7	4.13
	25 + 25 + 71	2.17	2.17	6.16	-	-	1.4	10.5	11.3	430	2540	2900	11.7	11.2	10.7	4.13
	25 + 25 + 80	2.02	2.02	6.46	-	-	1.4	10.5	11.3	430	2540	2900	11.7	11.2	10.7	4.13
	25 + 35 + 35	2.76	3.87	3.87	-	-	1.4	10.5	11.3	430	2540	2900	11.7	11.2	10.7	4.13
	25 + 35 + 50	2.39	3.34	4.77	-	-	1.4	10.5	11.3	430	2540	2900	11.7	11.2	10.7	4.13
	25 + 35 + 60	2.19	3.06	5.25	-	-	1.4	10.5	11.3	430	2540	2900	11.7	11.2	10.7	4.13
	25 + 35 + 71	2.00	2.81	5.69	-	-	1.4	10.5	11.3	430	2540	2900	11.7	11.2	10.7	4.13
	25 + 35 + 80	1.88	2.63	6.00	-	-	1.4	10.5	11.3	430	2540	2900	11.7	11.2	10.7	4.13
	25 + 50 + 50	2.10	4.20	4.20	-	-	1.4	10.5	11.3	430	2540	2900	11.7	11.2	10.7	4.13
	25 + 50 + 60	1.94	3.89	4.67	-	-	1.4	10.5	11.3	430	2540	2900	11.7	11.2	10.7	4.13
	25 + 50 + 71	1.80	3.60	5.11	-	-	1.4	10.5	11.3	430	2540	2900	11.7	11.2	10.7	4.13
	25 + 50 + 80	1.69	3.39	5.42	-	-	1.4	10.5	11.3	430	2540	2900	11.7	11.2	10.7	4.13
	25 + 60 + 60	1.81	4.34	4.34	-	-	1.4	10.5	11.3	430	2540	2900	11.7	11.2	10.7	4.13
	25 + 60 + 71	1.68	4.04	4.78	-	-	1.4	10.5	11.3	430	2540	2900	11.7	11.2	10.7	4.13
	35 + 35 + 35	3.50	3.50	3.50	-	-	1.4	10.5	11.3	430	2540	2900	11.7	11.2	10.7	4.13
	35 + 35 + 50	3.06	3.06	4.38	-	-	1.4	10.5	11.3	430	2540	2900	11.7	11.2	10.7	4.13
	35 + 35 + 60	2.83	2.83	4.85	-	-	1.4	10.5	11.3	430	2540	2900	11.7	11.2	10.7	4.13
	35 + 35 + 71	2.61	2.61	5.29	-	-	1.4	10.5	11.3	430	2540	2900	11.7	11.2	10.7	4.13
	35 + 35 + 80	2.45	2.45	5.60	-	-	1.4	10.5	11.3	430	2540	2900	11.7	11.2	10.7	4.13
	35 + 50 + 50	2.72	3.89	3.89	-	-	1.4	10.5	11.3	430	2540	2900	11.7	11.2	10.7	4.13
	35 + 50 + 60	2.53	3.62	4.34	-	-	1.4	10.5	11.3	430	2540	2900	11.7	11.2	10.7	4.13
35 + 50 + 71	2.36	3.37	4.78	-	-	1.4	10.5	11.3	430	2540	2900	11.7	11.2	10.7	4.13	
35 + 60 + 60	2.37	4.06	4.06	-	-	1.4	10.5	11.3	430	2540	2900	11.7	11.2	10.7	4.13	
50 + 50 + 50	3.50	3.50	3.50	-	-	1.4	10.5	11.3	430	2540	2900	11.7	11.2	10.7	4.13	
50 + 50 + 60	3.28	3.28	3.94	-	-	1.4	10.5	11.3	430	2540	2900	11.7	11.2	10.7	4.13	
4 room	20 + 20 + 20 + 20	2.63	2.63	2.63	2.63	-	1.6	10.5	11.4	400	2460	2900	11.3	10.8	10.4	4.27
	20 + 20 + 20 + 25	2.47	2.47	2.47	3.09	-	1.6	10.5	11.4	400	2460	2900	11.3	10.8	10.4	4.27
	20 + 20 + 20 + 35	2.21	2.21	2.21	3.87	-	1.6	10.5	11.4	400	2460	2900	11.3	10.8	10.4	4.27
	20 + 20 + 20 + 50	1.91	1.91	1.91	4.77	-	1.6	10.5	11.4	400	2460	2900	11.3	10.8	10.4	4.27
	20 + 20 + 20 + 60	1.75	1.75	1.75	5.25	-	1.6	10.5	11.4	400	2460	2900	11.3	10.8	10.4	4.27
	20 + 20 + 20 + 71	1.60	1.60	1.60	5.69	-	1.6	10.5	11.4	400	2460	2900	11.3	10.8	10.4	4.27
	20 + 20 + 20 + 80	1.50	1.50	1.50	6.00	-	1.6	10.5	11.4	400	2460	2900	11.3	10.8	10.4	4.27
	20 + 20 + 25 + 25	2.33	2.33	2.92	2.92	-	1.6	10.5	11.4	400	2460	2900	11.3	10.8	10.4	4.27
	20 + 20 + 25 + 35	2.10	2.10	2.63	3.68	-	1.6	10.5	11.4	400	2460	2900	11.3	10.8	10.4	4.27
	20 + 20 + 25 + 50	1.83	1.83	2.28	4.57	-	1.6	10.5	11.4	400	2460	2900	11.3	10.8	10.4	4.27
	20 + 20 + 25 + 60	1.68	1.68	2.10	5.04	-	1.6	10.5	11.4	400	2460	2900	11.3	10.8	10.4	4.27
	20 + 20 + 25 + 71	1.54	1.54	1.93	5.48	-	1.6	10.5	11.4	400	2460	2900	11.3	10.8	10.4	4.27
	20 + 20 + 25 + 80	1.45	1.45	1.81	5.79	-	1.6	10.5	11.4	400	2460	2900	11.3	10.8	10.4	4.27
	20 + 20 + 35 + 35	1.91	1.91	3.34	3.34	-	1.6	10.5	11.4	400	2460	2900	11.3	10.8	10.4	4.27
	20 + 20 + 35 + 50	1.68	1.68	2.94	4.20	-	1.6	10.5	11.4	400	2460	2900	11.3	10.8	10.4	4.27
	20 + 20 + 35 + 60	1.56	1.56	2.72	4.67	-	1.6	10.5	11.4	400	2460	2900	11.3	10.8	10.4	4.27
	20 + 20 + 35 + 71	1.44	1.44	2.52	5.11	-	1.6	10.5	11.4	400	2460	2900	11.3	10.8	10.4	4.27
	20 + 20 + 35 + 80	1.35	1.35	2.37	5.42	-	1.6	10.5	11.4	400	2460	2900	11.3	10.8	10.4	4.27
	20 + 20 + 50 + 50	1.50	1.50	3.75	3.75	-	1.6	10.5	11.4	400	2460	2900	11.3	10.8	10.4	4.27
	20 + 20 + 50 + 60	1.40	1.40	3.50	4.20	-	1.6	10.5	11.4	400	2460	2900	11.3	10.8	10.4	4.27
	20 + 20 + 60 + 60	1.31	1.31	3.94	3.94	-	1.6	10.5	11.4	400	2460	2900	11.3	10.8	10.4	4.27
20 + 25 + 25 + 25	2.21	2.76	2.76	2.76	-	1.6	10.5	11.4	400	2460	2900	11.3	10.8	10.4	4.27	
20 + 25 + 25 + 35	2.00	2.50	2.50	3.50	-	1.6	10.5	11.4	400	2460	2900	11.3	10.8	10.4	4.27	
20 + 25 + 25 + 50	1.75	2.19	2.19	4.38	-	1.6	10.5	11.4	400	2460	2900	11.3	10.8	10.4	4.27	

<Heating>

Indoor unit combination		Heating capacity (kW)									Power consumption (W)			Standard current (A)			COP
		Room heating capacity					Total capacity				Min.	Standard	Max.	220V	230V	240V	
		A	B	C	D	E	Min.	Standard	Max.	Standard							
4 room	20 + 25 + 25 + 60	1.62	2.02	2.02	4.85	-	1.6	10.5	11.4	400	2460	2900	11.3	10.8	10.4	4.27	
	20 + 25 + 25 + 71	1.49	1.86	1.86	5.29	-	1.6	10.5	11.4	400	2460	2900	11.3	10.8	10.4	4.27	
	20 + 25 + 25 + 80	1.40	1.75	1.75	5.60	-	1.6	10.5	11.4	400	2460	2900	11.3	10.8	10.4	4.27	
	20 + 25 + 35 + 35	1.83	2.28	3.20	3.20	-	1.6	10.5	11.4	400	2460	2900	11.3	10.8	10.4	4.27	
	20 + 25 + 35 + 50	1.62	2.02	2.83	4.04	-	1.6	10.5	11.4	400	2460	2900	11.3	10.8	10.4	4.27	
	20 + 25 + 35 + 60	1.50	1.88	2.63	4.50	-	1.6	10.5	11.4	400	2460	2900	11.3	10.8	10.4	4.27	
	20 + 25 + 35 + 71	1.39	1.74	2.43	4.94	-	1.6	10.5	11.4	400	2460	2900	11.3	10.8	10.4	4.27	
	20 + 25 + 35 + 80	1.31	1.64	2.30	5.25	-	1.6	10.5	11.4	400	2460	2900	11.3	10.8	10.4	4.27	
	20 + 25 + 50 + 50	1.45	1.81	3.62	3.62	-	1.6	10.5	11.4	400	2460	2900	11.3	10.8	10.4	4.27	
	20 + 25 + 50 + 60	1.35	1.69	3.39	4.06	-	1.6	10.5	11.4	400	2460	2900	11.3	10.8	10.4	4.27	
	20 + 35 + 35 + 35	1.68	2.94	2.94	2.94	-	1.6	10.5	11.4	400	2460	2900	11.3	10.8	10.4	4.27	
	20 + 35 + 35 + 50	1.50	2.63	2.63	3.75	-	1.6	10.5	11.4	400	2460	2900	11.3	10.8	10.4	4.27	
	20 + 35 + 35 + 60	1.40	2.45	2.45	4.20	-	1.6	10.5	11.4	400	2460	2900	11.3	10.8	10.4	4.27	
	20 + 35 + 50 + 50	1.35	2.37	3.39	3.39	-	1.6	10.5	11.4	400	2460	2900	11.3	10.8	10.4	4.27	
	25 + 25 + 25 + 25	2.63	2.63	2.63	2.63	-	1.6	10.5	11.4	400	2460	2900	11.3	10.8	10.4	4.27	
	25 + 25 + 25 + 35	2.39	2.39	2.39	3.34	-	1.6	10.5	11.4	400	2460	2900	11.3	10.8	10.4	4.27	
	25 + 25 + 25 + 50	2.10	2.10	2.10	4.20	-	1.6	10.5	11.4	400	2460	2900	11.3	10.8	10.4	4.27	
	25 + 25 + 25 + 60	1.94	1.94	1.94	4.67	-	1.6	10.5	11.4	400	2460	2900	11.3	10.8	10.4	4.27	
	25 + 25 + 25 + 71	1.80	1.80	1.80	5.11	-	1.6	10.5	11.4	400	2460	2900	11.3	10.8	10.4	4.27	
	25 + 25 + 25 + 80	1.69	1.69	1.69	5.42	-	1.6	10.5	11.4	400	2460	2900	11.3	10.8	10.4	4.27	
	25 + 25 + 35 + 35	2.19	2.19	3.06	3.06	-	1.6	10.5	11.4	400	2460	2900	11.3	10.8	10.4	4.27	
	25 + 25 + 35 + 50	1.94	1.94	2.72	3.89	-	1.6	10.5	11.4	400	2460	2900	11.3	10.8	10.4	4.27	
	25 + 25 + 35 + 60	1.81	1.81	2.53	4.34	-	1.6	10.5	11.4	400	2460	2900	11.3	10.8	10.4	4.27	
	25 + 25 + 35 + 71	1.68	1.68	2.36	4.78	-	1.6	10.5	11.4	400	2460	2900	11.3	10.8	10.4	4.27	
	25 + 25 + 50 + 50	1.75	1.75	3.50	3.50	-	1.6	10.5	11.4	400	2460	2900	11.3	10.8	10.4	4.27	
	25 + 25 + 50 + 60	1.64	1.64	3.28	3.94	-	1.6	10.5	11.4	400	2460	2900	11.3	10.8	10.4	4.27	
	25 + 35 + 35 + 35	2.02	2.83	2.83	2.83	-	1.6	10.5	11.4	400	2460	2900	11.3	10.8	10.4	4.27	
	25 + 35 + 35 + 50	1.81	2.53	2.53	3.62	-	1.6	10.5	11.4	400	2460	2900	11.3	10.8	10.4	4.27	
	25 + 35 + 35 + 60	1.69	2.37	2.37	4.06	-	1.6	10.5	11.4	400	2460	2900	11.3	10.8	10.4	4.27	
	25 + 35 + 50 + 50	1.64	2.30	3.28	3.28	-	1.6	10.5	11.4	400	2460	2900	11.3	10.8	10.4	4.27	
	35 + 35 + 35 + 35	2.63	2.63	2.63	2.63	-	1.6	10.5	11.4	400	2460	2900	11.3	10.8	10.4	4.27	
	35 + 35 + 35 + 50	2.37	2.37	2.37	3.39	-	1.6	10.5	11.4	400	2460	2900	11.3	10.8	10.4	4.27	
	5 room	20 + 20 + 20 + 20 + 20	2.10	2.10	2.10	2.10	2.10	1.8	10.5	11.5	370	2380	2900	10.9	10.5	10.0	4.41
		20 + 20 + 20 + 20 + 25	2.00	2.00	2.00	2.00	2.50	1.8	10.5	11.5	370	2380	2900	10.9	10.5	10.0	4.41
		20 + 20 + 20 + 20 + 35	1.83	1.83	1.83	1.83	3.20	1.8	10.5	11.5	370	2380	2900	10.9	10.5	10.0	4.41
20 + 20 + 20 + 20 + 50		1.62	1.62	1.62	1.62	4.04	1.8	10.5	11.5	370	2380	2900	10.9	10.5	10.0	4.41	
20 + 20 + 20 + 20 + 60		1.50	1.50	1.50	1.50	4.50	1.8	10.5	11.5	370	2380	2900	10.9	10.5	10.0	4.41	
20 + 20 + 20 + 25 + 25		1.91	1.91	1.91	2.39	2.39	1.8	10.5	11.5	370	2380	2900	10.9	10.5	10.0	4.41	
20 + 20 + 20 + 25 + 35		1.75	1.75	1.75	2.19	3.06	1.8	10.5	11.5	370	2380	2900	10.9	10.5	10.0	4.41	
20 + 20 + 20 + 25 + 50		1.56	1.56	1.56	1.94	3.89	1.8	10.5	11.5	370	2380	2900	10.9	10.5	10.0	4.41	
20 + 20 + 20 + 25 + 60		1.45	1.45	1.45	1.81	4.34	1.8	10.5	11.5	370	2380	2900	10.9	10.5	10.0	4.41	
20 + 20 + 20 + 35 + 35		1.62	1.62	1.62	2.83	2.83	1.8	10.5	11.5	370	2380	2900	10.9	10.5	10.0	4.41	
20 + 20 + 20 + 35 + 50		1.45	1.45	1.45	2.53	3.62	1.8	10.5	11.5	370	2380	2900	10.9	10.5	10.0	4.41	
20 + 20 + 20 + 35 + 60		1.35	1.35	1.35	2.37	4.06	1.8	10.5	11.5	370	2380	2900	10.9	10.5	10.0	4.41	
20 + 20 + 25 + 25 + 25		1.83	1.83	2.28	2.28	2.28	1.8	10.5	11.5	370	2380	2900	10.9	10.5	10.0	4.41	
20 + 20 + 25 + 25 + 35		1.68	1.68	2.10	2.10	2.94	1.8	10.5	11.5	370	2380	2900	10.9	10.5	10.0	4.41	
20 + 20 + 25 + 25 + 50		1.50	1.50	1.88	1.88	3.75	1.8	10.5	11.5	370	2380	2900	10.9	10.5	10.0	4.41	
20 + 20 + 25 + 25 + 60		1.40	1.40	1.75	1.75	4.20	1.8	10.5	11.5	370	2380	2900	10.9	10.5	10.0	4.41	
20 + 20 + 25 + 35 + 35		1.56	1.56	1.94	2.72	2.72	1.8	10.5	11.5	370	2380	2900	10.9	10.5	10.0	4.41	
20 + 20 + 25 + 35 + 50		1.40	1.40	1.75	2.45	3.50	1.8	10.5	11.5	370	2380	2900	10.9	10.5	10.0	4.41	
20 + 20 + 25 + 35 + 60		1.31	1.31	1.64	2.30	3.94	1.8	10.5	11.5	370	2380	2900	10.9	10.5	10.0	4.41	
20 + 20 + 35 + 35 + 35		1.45	1.45	2.53	2.53	2.53	1.8	10.5	11.5	370	2380	2900	10.9	10.5	10.0	4.41	
20 + 20 + 35 + 35 + 50		1.31	1.31	2.30	2.30	3.28	1.8	10.5	11.5	370	2380	2900	10.9	10.5	10.0	4.41	
20 + 25 + 25 + 25 + 25	1.75	2.19	2.19	2.19	2.19	1.8	10.5	11.5	370	2380	2900	10.9	10.5	10.0	4.41		
20 + 25 + 25 + 25 + 35	1.62	2.02	2.02	2.02	2.83	1.8	10.5	11.5	370	2380	2900	10.9	10.5	10.0	4.41		

<Heating>

Indoor unit combination		Heating capacity (kW)									Power consumption (W)			Standard current (A)			COP
		Room heating capacity					Total capacity				Min.	Standard	Max.	220V	230V	240V	Standard
		A	B	C	D	E	Min.	Standard	Max.								
5 room	20 + 25 + 25 + 25 + 50	1.45	1.81	1.81	1.81	3.62	1.8	10.5	11.5	370	2380	2900	10.9	10.5	10.0	4.41	
	20 + 25 + 25 + 25 + 60	1.35	1.69	1.69	1.69	4.06	1.8	10.5	11.5	370	2380	2900	10.9	10.5	10.0	4.41	
	20 + 25 + 25 + 35 + 35	1.50	1.88	1.88	2.63	2.63	1.8	10.5	11.5	370	2380	2900	10.9	10.5	10.0	4.41	
	20 + 25 + 25 + 35 + 50	1.35	1.69	1.69	2.37	3.39	1.8	10.5	11.5	370	2380	2900	10.9	10.5	10.0	4.41	
	20 + 25 + 35 + 35 + 35	1.40	1.75	2.45	2.45	2.45	1.8	10.5	11.5	370	2380	2900	10.9	10.5	10.0	4.41	
	20 + 35 + 35 + 35 + 35	1.31	2.30	2.30	2.30	2.30	1.8	10.5	11.5	370	2380	2900	10.9	10.5	10.0	4.41	
	25 + 25 + 25 + 25 + 25	2.10	2.10	2.10	2.10	2.10	1.8	10.5	11.5	370	2380	2900	10.9	10.5	10.0	4.41	
	25 + 25 + 25 + 25 + 35	1.94	1.94	1.94	1.94	2.72	1.8	10.5	11.5	370	2380	2900	10.9	10.5	10.0	4.41	
	25 + 25 + 25 + 25 + 50	1.75	1.75	1.75	1.75	3.50	1.8	10.5	11.5	370	2380	2900	10.9	10.5	10.0	4.41	
	25 + 25 + 25 + 25 + 60	1.64	1.64	1.64	1.64	3.94	1.8	10.5	11.5	370	2380	2900	10.9	10.5	10.0	4.41	
	25 + 25 + 25 + 35 + 35	1.81	1.81	1.81	2.53	2.53	1.8	10.5	11.5	370	2380	2900	10.9	10.5	10.0	4.41	
	25 + 25 + 25 + 35 + 50	1.64	1.64	1.64	2.30	3.28	1.8	10.5	11.5	370	2380	2900	10.9	10.5	10.0	4.41	
	25 + 25 + 35 + 35 + 35	1.69	1.69	2.37	2.37	2.37	1.8	10.5	11.5	370	2380	2900	10.9	10.5	10.0	4.41	

6. SELECTION CHARTS

Correct the cooling and heating capacity in accordance with the conditions as follows. The net cooling and heating capacity can be obtained in the following way.

Net capacity = Capacity shown on specification × Correction factors as follows.

(1) Coefficient of cooling and heating capacity in relation to temperatures

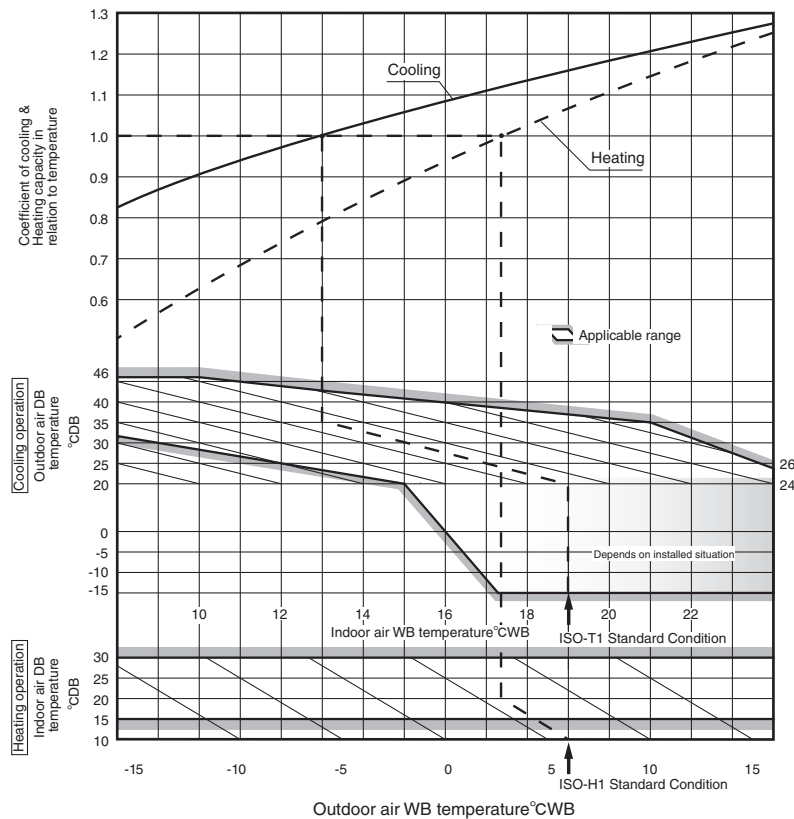

(2) Correction of cooling and heating capacity in relation to one way length of refrigerant piping

It is necessary to correct the cooling and heating capacity in relation to the one way piping length between the indoor and outdoor units.

Piping length [m]	7	10	15	20	25
Cooling	1.0	0.99	0.975	0.965	0.95
Heating	1.0	1.0	1.0	1.0	1.0

(3) Correction relative to frosting on outdoor heat exchanger during heating

In additions to the foregoing corrections (1), (2) the heating capacity needs to be adjusted also with respect to the frosting on the outdoor heat exchanger.

Air inlet temperature of outdoor unit in °CWB	-15	-10	-9	-7	-5	-3	-1	1	3	5 or more
Adjustment coefficient	0.95	0.95	0.94	0.93	0.91	0.88	0.86	0.87	0.92	1.00

How to obtain the cooling and heating capacity

Example : The net cooling capacity of the model SCM100ZS-W (SRK25ZS-W : 5 units) with the piping length of 10m, indoor wet-bulb temperature at 19.0°C and outdoor dry-bulb temperature 35°C is

$$\text{Net cooling capacity} = \underbrace{(2.0 \times 5)}_{\substack{\text{Table of indoor unit combination (Refer to page 220)} \\ \text{Outdoor unit SCM100ZS-W} \\ \text{Indoor unit SRK25ZS-W} \times 5 \text{ units}}} \times \underbrace{0.99}_{\text{Length 10m}} \times \underbrace{1.0}_{\text{Factor by air temperatures}} \doteq 9.9\text{kW}$$

7. TABLE OF FUNCTIONS CONNECTED WIRED REMOTE CONTROL (RC-E5)

If wired remote control (option part) is connected to the following indoor units, some of the functions cannot be used. Please see following table for details.

- Wall mounted type : SRK**ZSX-W, ZS-W, SKM**ZSP-W
- Ceiling concealed type : SRR**ZM-W

○ : OK, △ : Conditionally OK, × : N/A

No.	Functions	SRK	SRR	Outline of function	Remarks
1	Several remote controls for 1 unit	○	○	Indoor unit can be connected max. 2 remote controls.	
2	Control of several indoor units	○	○	One remote control can be connected to max. of 16 indoor units.	
3	Central control	○	○	Signal of center mode from central control can be restricted to operation of remote control.	
4	Run/Stop	○	○		
5	Change operation mode	○	○	Display of operation mode range is automatically decided from the indoor unit's information.	
6	Adjust fan speed	○	○	Display of airflow range is automatically decided from the indoor unit's information.	
7	Auto swing of flap	○	×	Display of air flow direction ON/OFF is automatically decided from the indoor unit's information.	Flap control only. Louver cannot be controlled.
8	Setting of air flow direction	×	×	Setting of air flow direction for indoor unit that can be changed air flow direction.	
9	Setting of temperature	△	△		Temperature range can be set from 18 degree to 30 degree. Carving 0.5°C is rounded up.
10	Timer operation	○	○	Sleep timer mode, Off timer mode, On timer mode, Weekly timer mode.	Warm up timer and sleep control of on timer mode is impossible.
11	Ventilation control	×	×	Air infiltration can be controlled by the indoor unit that has this function.	RAC unit does not have this function.
12	Display of unit number	○	○	Display address number of remote control.	Address set by SC-BIKN2-E for RAC
13	Service switch-1: Display of error data	△	△	Display and memorize the error code data that are checked finally.	Only error code is used in the RAC unit.
14	Service switch-2 display of operation data	△	△	Display operation data.	RAC unit can be displayed some data.
15	Trial run	○	○	Cooling operation signal is sent to the indoor unit.	
16	Forced operation of drain pump	×	×	Forced operation of drain pump is sent to the indoor unit.	
17	Setting of compressor frequency	○	○	Fixing compressor frequency.	
18	Quiet mode	×	×	On timer in order to start quiet mode.	RAC unit does not have this function.
19	Auto address change from remote control	×	×	Auto address can be changed from remote control.	RAC unit does not have this function.
20	Indoor unit's address set of master	×	×	Adapt control for 3 pipe system.	RAC unit does not have this function.
21	Filter reset	×	×	Turning off signal display of filter sign and sending reset signal of operating time.	RAC unit does not have this function.
22	Clear memory of error code in remote control	○	○	Reset memory that remote control has the error code.	
23	Clear memory of error code in the indoor unit	○	○	Reset memory of error for the indoor unit.	
24	Clear address in indoor unit	×	×	Reset memory of address for the indoor unit.	RAC unit does not have this function.
25	Reset CPU	○	○	Reset outdoor or indoor CPU.	
26	Function setting	△	△	It is possible to set the function of remote control and indoor unit.	RAC unit can be set a part of function.
27	Setting of temperature range	△	△	Set Max and Min temperature.	For RAC models, only the range from 18°C to 30°C is available.
28	External input	○	○	External input from ChT terminal can be switched between all unit operation and individual operation.	
29	Auto adjustment of static pressure	×	×	Change auto adjustment of static pressure.	RAC unit does not have this function.
30	Setting of static pressure	×	×	Displayed part blinks on and off when it receives a signal about auto adjustment of static pressure mode.	RAC unit does not have this function.
31	Filter sign	×	×	Displays filter sign via signal from indoor unit when counting time achieves target time.	RAC unit does not have this function.



8. OPTION PARTS

8.1 Wired remote control

(1) Model RC-EX3A

1) Safety precautions

- Please read this manual carefully before starting installation work to install the unit properly. Every one of the followings is important information to be observed strictly.

 WARNING	Failure to follow these instructions properly may result in serious consequences such as death, severe injury, etc.
 CAUTION	Failure to follow these instructions properly may cause injury or property damage.

It could have serious consequences depending on the circumstances.

- The following pictograms are used in the text.

	Never do.		Always follow the instructions given.
---	-----------	---	---------------------------------------

- Keep this manual at a safe place where you can consult with whenever necessary. Show this manual to installers when moving or repairing the unit. When the ownership of the unit is transferred, this manual should be given to a new owner.

WARNING



Consult your dealer or a professional contractor to install the unit.
Improper installation made on your own may cause electric shocks, fire or dropping of the unit.



Installation work should be performed properly according to this installation manual.
Improper installation work may result in electric shocks, fire or break-down.



Be sure to use accessories and specified parts for installation work.
Use of unspecified parts may result in drop, fire or electric shocks.



Install the unit properly to a place with sufficient strength to hold the weight.
If the place is not strong enough, the unit may drop and cause injury.



Be sure to have the electrical wiring work done by qualified electrical installer, and use exclusive circuit.
Power source with insufficient and improper work can cause electric shock and fire.



Shut OFF the main power source before starting electrical work.
Otherwise, it could result in electric shocks, break-down or malfunction.



Do not modify the unit.
It could cause electric shocks, fire, or break-down.



Be sure to turn OFF the power circuit breaker before repairing/ inspecting the unit.
Repairing/inspecting the unit with the power circuit breaker turned ON could cause electric shocks or injury.

 **WARNING**

Do not install the unit in appropriate environment or where inflammable gas could generate, flow in, accumulate or leak.



If the unit is used at places where air contains dense oil mist, steam, organic solvent vapor, corrosive gas (ammonium, sulfuric compound, acid, etc) or where acidic or alkaline solution, special spray, etc. are used, it could cause electric shocks, break-down, smoke or fire as a result of significant deterioration of its performance or corrosion.

Do not install the unit where water vapor is generated excessively or condensation occurs.



It could cause electric shocks, fire, or break-down.

Do not use the unit in a place where it gets wet, such as laundry room.



It could cause electric shocks, fire, or break-down.

Do not operate the unit with wet hands.



It could cause electric shocks.

Do not wash the unit with water.



It could cause electric shocks, fire, or break-down.

Use the specified cables for wiring, and connect them securely with care to protect electronic parts from external forces.



Improper connections or fixing could cause heat generation, fire, etc.

Seal the inlet hole for remote control cable with putty.



If dew, water, insect, etc. enters through the hole, it could cause electric shocks, fire or break-down.

If dew or water enters the unit, it may cause screen display anomalies.

When installing the unit at a hospital, telecommunication facility, etc., take measures to suppress electric noises.



It could cause malfunction or break-down due to hazardous effects on the inverter, private power generator, high frequency medical equipment, radio communication equipment, etc.

The influences transmitted from the remote control to medical or communication equipment could disrupt medical activities, video broadcasting or cause noise interference.

Do not leave the remote control with its upper case removed.



If dew, water, insect, etc. enters through the hole, it could cause electric shocks, fire or break-down.

 **CAUTION****Do not install the remote control at following places.**

- (1) It could cause break-down or deformation of remote control.
- Where it is exposed to direct sunlight
 - Where the ambient temperature becomes 0 °C or below, or 40 °C or above
 - Where the surface is not flat
 - Where the strength of installation area is insufficient
- (2) Moisture may be attached to internal parts of the remote control, resulting in a display failure.
- Place with high humidity where condensation occurs on the remote control
 - Where the remote control gets wet
- (3) Accurate room temperature may not be detected using the temperature sensor of the remote control.
- Where the average room temperature cannot be detected
 - Place near the equipment to generate heat
 - Place affected by outside air in opening/closing the door
 - Place exposed to direct sunlight or wind from air-conditioner
 - Where the difference between wall and room temperature is large



To connect to a personal computer via USB, use the dedicated software.**Do not connect other USB devices and the remote control at the same time.**

It could cause malfunction or break-down of the remote control/personal computer.

2) Accessories & Prepare on site

Following parts are provided.

Accessories	R/C main unit, wood screw (ø3.5 x 16) 2 pcs., Quick reference
-------------	---

Following parts are arranged at site. Prepare them according to the respective installation procedures.

Item name	Q'ty	Remark
Switch box For 1 piece or 2 pieces (JIS C 8340 or equivalent)	1	These are not required when installing directly on a wall.
Thin wall steel pipe for electric appliance directly on a wall. (JIS C 8305 or equivalent)	As required	
Lock nut, bushing (JIS C 8330 or equivalent)	As required	
Lacing (JIS C 8425 or equivalent)	As required	Necessary to run R/C cable on the wall.
Putty	Suitably	For sealing gaps
Molly anchor	As required	
R/C cable (0.3mm ² x 2 pcs.)	As required	See right table when longer than 100m

When the cable length is longer than 100m, the max size for wires used in the R/C case is 0.5mm². Connect them to wires of larger size near the outside of R/C. When wires are connected, take measures to prevent water, etc. from entering inside.

≦ 200m	0.5mm ² x 2 cores
≦ 300m	0.75mm ² x 2 cores
≦ 400m	1.25mm ² x 2 cores
≦ 600m	2.0mm ² x 2 cores

3) Installation place

Secure the installation space shown in the figure.

For the installation method, "embedding wiring" or "exposing wiring" can be selected.

For the wiring direction, "Backward", "Upper center" or "Upper left" can be selected.

Determine the installation place in consideration of the installation method and wiring direction.

Installation space

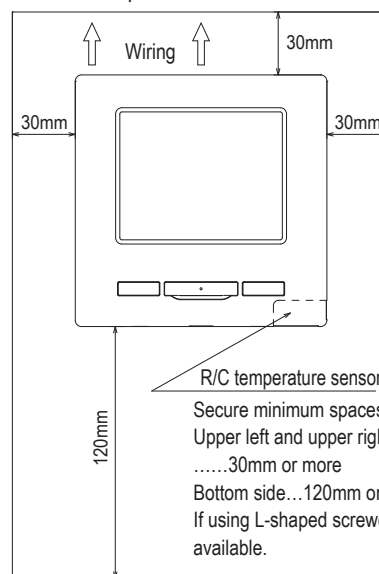

Secure minimum spaces for disassembling the case.
 Upper left and upper right sides
30mm or more
 Bottom side...120mm or more
 If using L-shaped screwdriver, 50mm or more is available.

4) Installation procedure

Perform installation and wiring work for the remote control according to the following procedure.

Dimensions (Viewed from front)

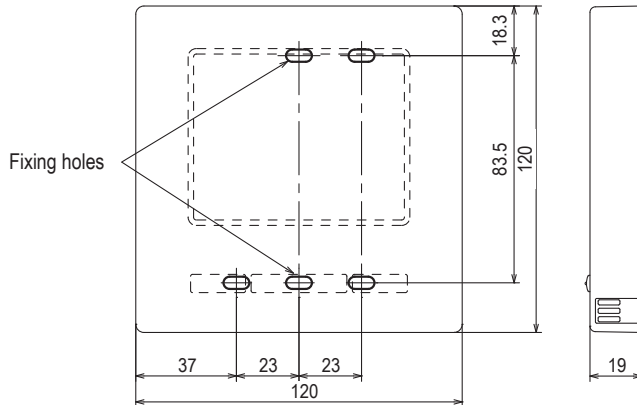

To disassemble the R/C case into the upper and lower pieces after assembling them once

- Insert the tip of flat head screwdriver or the like in the recess at the lower part of R/C and twist it lightly to remove. It is recommended that the tip of the screwdriver be wrapped with tape to avoid damaging the case.

Take care to protect the removed upper case from moisture or dust.

In case of embedding wiring

(When the wiring is retrieved "Backward")

① Embed the switch box and the R/C wires beforehand.

Seal the inlet hole for the R/C wiring with putty.

PCB side (Viewed from rear)

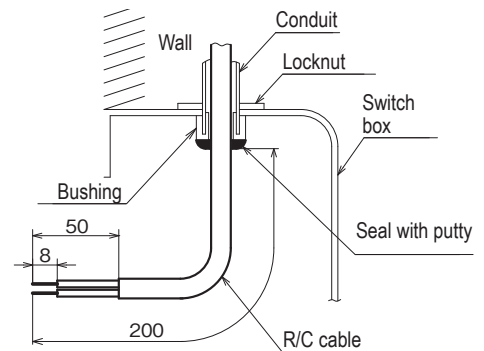
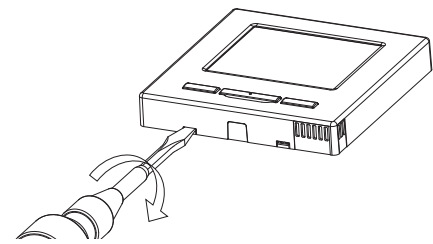
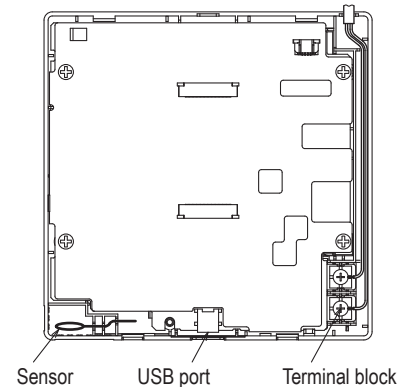

② When wires are passed through the bottom case, fix the bottom case at 2 places on the switch box.

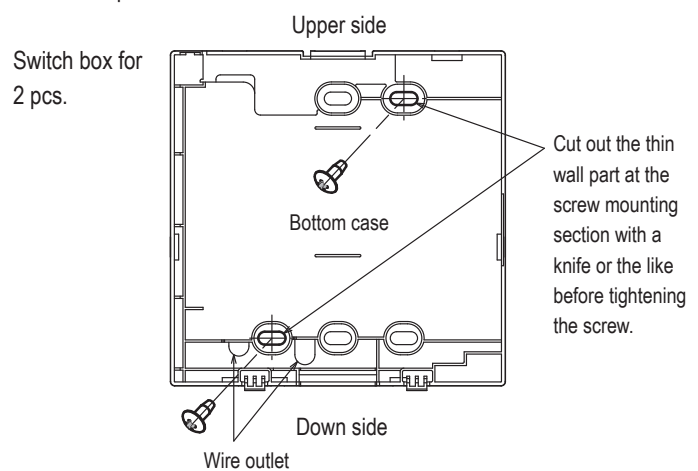
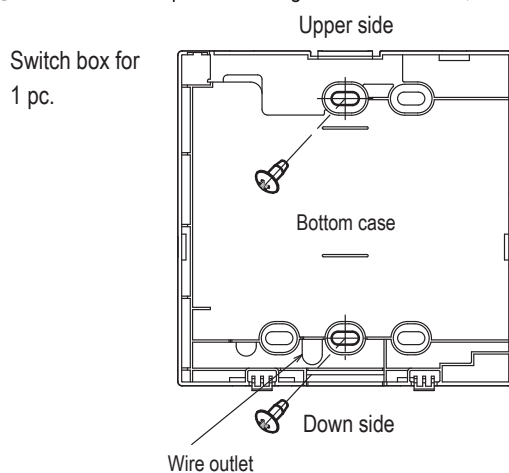

- ③ Connect wires from X and Y terminals of R/C to X and Y terminals of indoor unit. R/C wires (X, Y) have no polarity. Fix wires such that the wires will run around the terminal screws on the top case of R/C.
- ④ Install the upper case with care not to pinch wires of R/C.

Cautions for wire connection

Use wires of no larger than 0.5mm² for wiring running through the remote control case. Take care not to pinch the sheath.

Tighten by hand (0.7N·m or less) the wire connection. If the wire is connected using an electric driver, it may cause failure or deformation.

In case of exposing wiring

(When the wiring is taken out from the “upper center” or “upper left” of R/C)

- ① Cut out the thin wall sections on the cases for the size of wire.

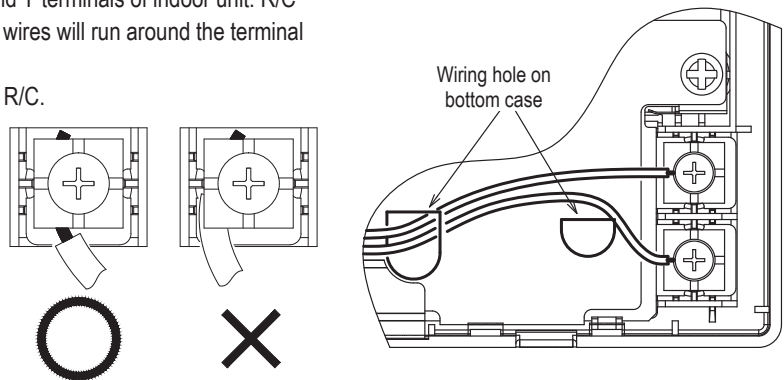

When taking the wiring out from the upper center, open a hole before separating the upper and bottom cases. This will reduce risk of damaging the PCB and facilitate subsequent work.
 When taking the wiring out from the upper left, take care not to damage the PCB and not to leave any chips of cut thin wall inside.

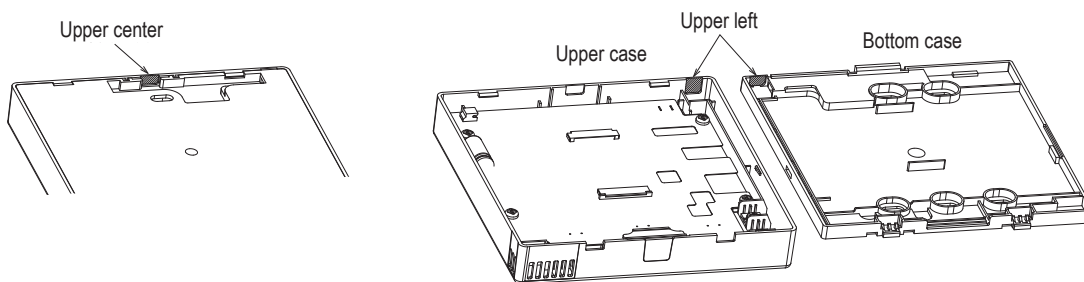

- ② Fix the bottom R/C case on a flat surface with two wood screws.
- ③ In case of the upper center, pass the wiring behind the bottom case. (Hatched section)
- ④ Connect wires from X and Y terminals of R/C to X and Y terminals of indoor unit. R/C wires (X, Y) have no polarity. Fix wires such that the wires will run around the terminal screws on the top case of R/C.
- ⑤ Install the top case with care not to pinch wires of R/C.
- ⑥ Seal the area cut in ① with putty.

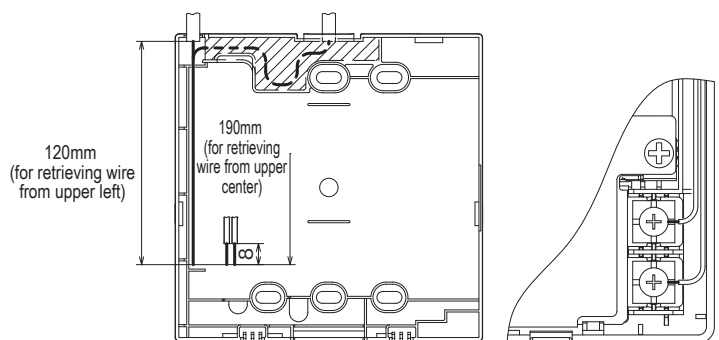

5) Main/Sub setting when more than one remote control are used

Up to two units of R/C can be used at the maximum for 1 indoor unit or 1 group.

One is main R/C and the other is sub R/C.

Operating range is different depending on the main or sub R/C.

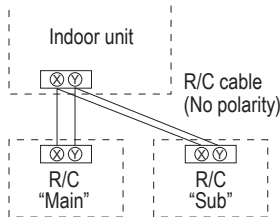

R/C operations		Main	Sub	
Run/Stop, Change set temp., Change flap direction, Auto swing, Change fan speed operations		○	○	
High power operation, Energy-saving operation		○	○	
Silent mode control		○	×	
Useful functions	Individual flap control	○	×	
	Anti draft setting	○	×	
	Timer	○	○	
	Favorite setting	○	○	
	Weekly timer	○	×	
	Home leave mode	○	×	
	External ventilation	○	○	
	Select the language	○	○	
	Silent mode control	○	×	
	Energy-saving setting		○	×
Filter	Filter sign reset	○	○	
User setting	Initial settings		○	○
	Administrator settings	Permission/Prohibition setting	○	×
		Outdoor unit silent mode timer	○	×
		Setting temp. range	○	×
	Temp increment setting	○	×	
	Set temp. display	○	○	
	R/C display setting	○	○	
	Change administrator password	○	○	
F1/F2 function setting	○	○		

○ : operable × : not operable

R/C operations		Main	Sub		
Service setting	Installation settings	Installation date	○	×	
		Company information	○	○	
		Test run	○	×	
		Static pressure adjustment	○	×	
		Change auto-address	○	×	
		Address setting of main IU	○	×	
		IU back-up function	○	×	
		Motion sensor setting	○	×	
		R/C function settings	Main/Sub of R/C	○	○
			Return air temp.	○	×
	R/C sensor		○	×	
	R/C sensor adjustment		○	×	
	Operation mode		○	×	
	°C / °F		○	×	
	Fan speed		○	×	
	External input		○	×	
	Upper/lower flap control		○	×	
	Left/right flap control		○	×	
	IU settings	Service & Maintenance	IU address	○	○
			Next service date	○	×
			Operation data	○	×
		Error display	Error history	○	○
			Display/erase anomaly data	○	×
			Reset periodical check	○	○
		Saving IU settings	○	×	
		Special settings	Erase IU address	○	×
			CPU reset	○	○
			Restore of default setting	○	×
			Touch panel calibration	○	○
		Indoor unit capacity display	○	×	

Advice: Connection to personal computer

It can be set from a personal computer via the USB port (mini-B). Connect after removing the cover for USB port of upper case. Replace the cover after use. Special software is necessary for the connection. For details, view the web site.

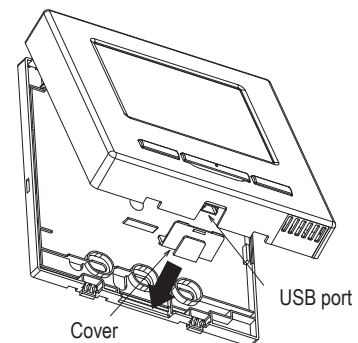

Advice: Initializing of password

Administrator password (for daily setting items) and service password (for installation, test run and maintenance) are used.

- The administrator password at factory default is "0000". This setting can be changed (Refer to User's Manual).
If the administrator password is forgotten, it can be initialized by holding down the [F1] and [F2] switches together for five seconds on the administrator password input screen.
- Service password is "9999", which cannot be changed.
When the administrator password is input, the service password is also accepted.

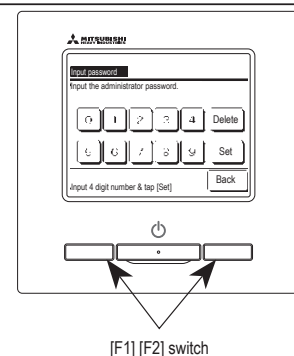

Advice

When connecting two or more FDT/FDTC to one R/C, unify the panel type either to a panel with anti draft function or a standard panel.

(2) Model RC-E5



Read together with indoor unit's installation manual.

⚠ WARNING

- Fasten the wiring to the terminal securely and hold the cable securely so as not to apply unexpected stress on the terminal.
Loose connection or hold will cause abnormal heat generation or fire. !
- Make sure the power source is turned off when electric wiring work.
Otherwise, electric shock, malfunction and improper running may occur. !

⚠ CAUTION

- Do not install the remote control at the following places in order to avoid malfunction.

(1) Places exposed to direct sunlight	(4) Hot surface or cold surface enough to generate condensation
(2) Places near heat devices	(5) Places exposed to oil mist or steam directly
(3) High humidity places	(6) Uneven surface

⊘
- Do not leave the remote control without the upper case.
In case the upper case needs to be detached, protect the remote control with a packaging box or bag in order to keep it away from water and dust. ⊘

Accessories	Remote control, wood screw (φ3.5×16) 2 pieces
Prepare on site	Remote control cord (2 cores) the insulated thickness in 1mm or more. [In case of embedding cord] Electrical box, M4 screw (2 pieces) [In case of exposing cord] Cord clamp (if needed)

Installation procedure

- ① Open the cover of remote control, and remove the screw under the buttons without fail.
- ② Remove the upper case of remote control.
Insert a flat-blade screwdriver into the dented part of the upper part of the remote control, and wrench slightly.

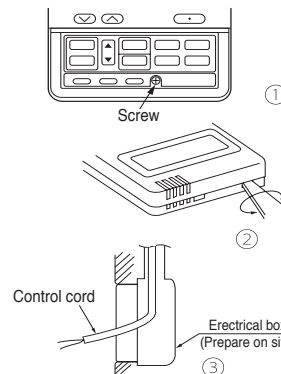

[In case of embedding cord]

- ③ Embed the electrical box and remote control cord beforehand.

- ④ Prepare two M4 screws (recommended length is 12-16mm) on site, and install the lower case to electrical box. Choose either of the following two positions in fixing it with screws.

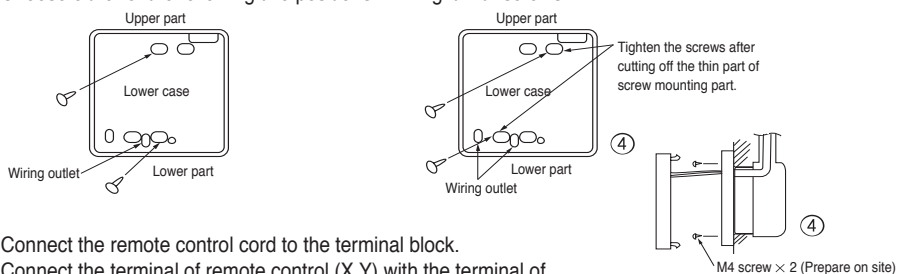

- ⑤ Connect the remote control cord to the terminal block.
Connect the terminal of remote control (X,Y) with the terminal of indoor unit (X,Y). (X and Y are no polarity)

- ⑥ Install the upper case as before so as not to catch up the remote control cord, and tighten with the screws.

[In case of exposing cord]

- ③ You can pull out the remote control cord from left upper part or center upper part.
Cut off the upper thin part of remote control lower case with a nipper or knife, and grind burrs with a file etc.
- ④ Install the lower case to the flat wall with attached two wooden screws.

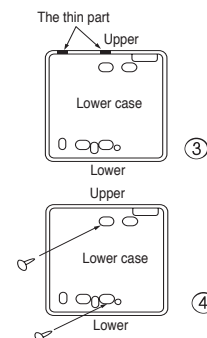

- ⑤ Connect the remote control cord to the terminal block.
 Connect the terminal of remote control (X,Y) with the terminal of indoor unit (X,Y).
 (X and Y are no polarity)
 Wiring route is as shown in the right diagram depending on the pulling out direction.

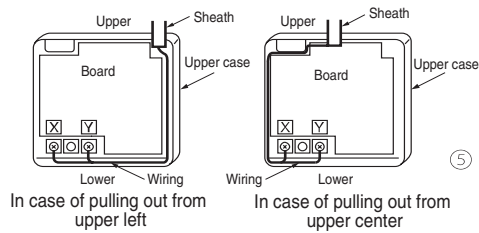

The wiring inside the remote control case should be within 0.3mm² (recommended) to 0.5mm².
 The sheath should be peeled off inside the remote control case.
 The peeling-off length of each wire is as below.

Pulling out from upper left	Pulling out from upper center
X wiring : 215mm	X wiring : 170mm
Y wiring : 195mm	Y wiring : 190mm

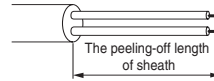

- ⑥ Install the upper case as before so as not to catch up the remote control cord, and tighten with the screws.
 ⑦ In case of exposing cord, fix the cord on the wall with cord clamp so as not to slack.

Installation and wiring of remote control

- ① Wiring of remote control should use 0.3mm² × 2 cores wires or cables. (on-site configuration)
 ② Maximum prolongation of remote control wiring is 600m.
 If the prolongation is over 100m, change to the size below.
 But, wiring in the remote control case should be under 0.5mm². Change the wire size outside of the case according to wire connecting. Waterproof treatment is necessary at the wire connecting section. Be careful about contact failure.
- | | |
|------------|-------------------------------|
| 100 - 200m | 0.5mm ² × 2 cores |
| Under 300m | 0.75mm ² × 2 cores |
| Under 400m | 1.25mm ² × 2 cores |
| Under 500m | 2.0mm ² × 2 cores |

Master/ slave setting when more than one remote controls are used

A maximum of two remote controls can be connected to one indoor unit (or one group of indoor units.)

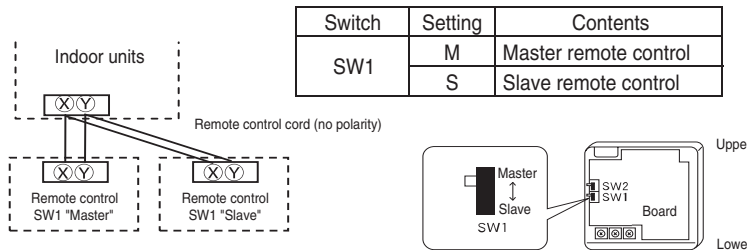

Set SW1 to "Slave" for the slave remote control. It was factory set to "Master" for shipment.
 Note: The setting "Remote control sensor enabled" is only selectable with the master remote control in the position where you want to check room temperature.
 The air-conditioner operation follows the last operation of the remote control regardless of the master/ slave setting of it.

The indication when power source is supplied

When power source is turned on, the following is displayed on the remote control until the communication between the remote control and indoor unit settled.

Master remote control : " WAIT M"
 Slave remote control : " WAIT S"

At the same time, a mark or a number will be displayed for two seconds first.
 This is the software's administration number of the remote control, not an error cord.

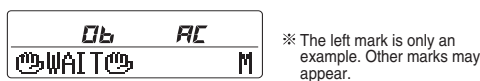

When remote control cannot communicate with the indoor unit for half an hour, the below indication will appear.
 Check wiring of the indoor unit and the outdoor unit etc.



The range of temperature setting

When shipped, the range of set temperature differs depending on the operation mode as below.

Heating : 16-30°C (55-86°F)

Except heating (cooling, fan, dry, automatic) : 18-30°C (62-86°F)

● **Upper limit and lower limit of set temperature can be changed with remote control.**

Upper limit setting: valid during heating operation. Possible to set in the range of 20 to 30°C (68 to 86°F).

Lower limit setting: valid except heating (automatic, cooling, fan, dry) Possible to set in the range of 18 to 26°C (62 to 79°F).

When you set upper and lower limit by this function, control as below.

1. When ⑫ TEMP RANGE SET, remote control function of function setting mode is "INDN CHANGE" (factory setting),
 【 If upper limit value is set 】

During heating, you cannot set the value exceeding the upper limit.

- 【 If lower limit value is set 】

During operation mode except heating, you cannot set the value below the lower limit.

2. When ⑫ TEMP RANGE SET, remote control function of function setting mode is "NO INDN CHANGE"

- 【 If upper limit value is set 】

During heating, even if the value exceeding the upper limit is set, upper limit value will be sent to the indoor unit.

But, the indication is the same as the temperature set.

- 【 If lower limit value is set 】

During except heating, even if the value lower than the lower limit is set, lower limit value will be sent to the indoor unit.

But, the indication is the same as the temperature set.

● **How to set upper and lower limit value**

1. Stop the air-conditioner, and press (SET) and (MODE) button at the same time for over three seconds .

The indication changes to "FUNCTION SET ▼".

2. Press button once, and change to the "TEMP RANGE ▲" indication.

3. Press (SET) button, and enter the temperature range setting mode.

4. Select "UPPER LIMIT ▼" or "LOWER LIMIT ▲" by using button.

5. Press (SET) button to fix.

6. When "UPPER LIMIT ▼" is selected (valid during heating)

① Indication: " ▼ ^ SET UP " → "UPPER 30°C ▼"

② Select the upper limit value with temperature setting button . Indication example: "UPPER 26°C ▼ ^" (blinking)

③ Press (SET) button to fix. Indication example: "UPPER 26°C" (Displayed for two seconds)

After the fixed upper limit value displayed for two seconds, the indication will return to "UPPER LIMIT ▼".

7. When "LOWER LIMIT ▲" is selected (valid during cooling, dry, fan, automatic)

① Indication: " ▼ ^ SET UP " → "LOWER 18°C ^"

② Select the lower limit value with temperature setting button . Indication example: "LOWER 24°C ▼ ^" (blinking)

③ Press (SET) button to fix. Indication for example: "LOWER 24°C" (Displayed for two seconds)

After the fixed lower limit value displayed for two seconds, the indication will return to "LOWER LIMIT ▼".

8. Press button to finish.

• It is possible to finish by pressing button on the way, but unfinished change of setting is unavailable.

• During setting, if you press (RESET) button, you return to the previous screen.

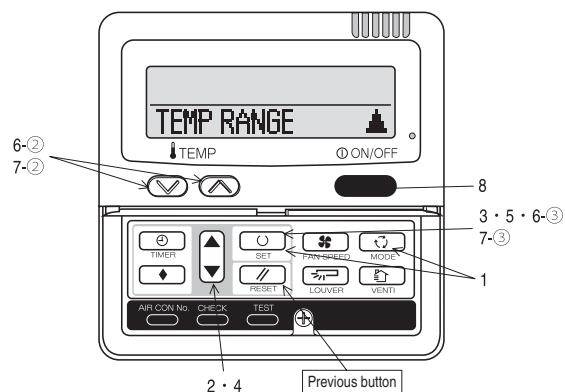

The functional setting

- The initial function setting for typical using is performed automatically by the indoor unit connected, when remote control and indoor unit are connected.
- As long as they are used in a typical manner, there will be no need to change the initial settings.
- If you would like to change the initial setting marked "○", set your desired setting as for the selected item.
- The procedure of functional setting is shown as the following diagram.

[Flow of function setting]

Start : Stop air-conditioner and press "○" (SET) and "◀▶" (MODE) buttons at the same time for over three seconds.
 Finalize : Press "○" (SET) button.
 Reset : Press "⏮" (RESET) button.
 Select : Press "▲▼" button.
 End : Press [ON/OFF] button.

It is possible to finish above setting on the way, and unfinished change of setting is unavailable.
 "○": Initial settings
 "※": Automatic criterion

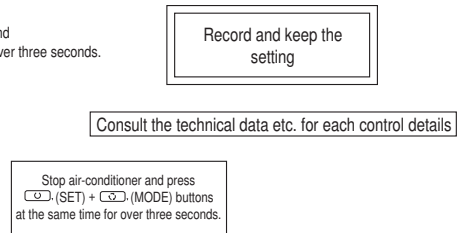

To next page

Function	setting	
◇ 01 ESP SET	ESP VALID	○ Validate setting of ESP: External Static Pressure
	ESP INVALID	○ Invalidate setting of ESP
02 AUTO RUN SET	AUTO RUN ON	※ Automatic operation is impossible
	AUTO RUN OFF	※
03 TEMP SW	VALID	○ Temperature setting button is not working
	INVALID	○
04 MODE SW	VALID	○ Mode button is not working
	INVALID	○
05 ON/OFF SW	VALID	○ On/Off button is not working
	INVALID	○
06 FAN SPEED SW	VALID	※ Fan speed button is not working
	INVALID	※
07 LOUVER SW	VALID	※ Louver button is not working
	INVALID	※
08 TIMER SW	VALID	○ Timer button is not working
	INVALID	○
* 09 SENSOR SET	SENSOR OFF	○ Remote sensor is not working.
	SENSOR ON	○ Remote sensor is working.
	SENSOR +3.0℃	○ Remote sensor is working, and to be set for producing +3.0°C increase in temperature.
	SENSOR +2.0℃	○ Remote sensor is working, and to be set for producing +2.0°C increase in temperature.
	SENSOR +1.0℃	○ Remote sensor is working, and to be set for producing +1.0°C increase in temperature.
	SENSOR -1.0℃	○ Remote sensor is working, and to be set for producing -1.0°C increase in temperature.
	SENSOR -2.0℃	○ Remote sensor is working, and to be set for producing -2.0°C increase in temperature.
	SENSOR -3.0℃	○ Remote sensor is working, and to be set for producing -3.0°C increase in temperature.
10 AUTO RESTART	INVALID	○
	VALID	○
◆◇ 11 VENT LINK SET	NO VENT	○ In case of Single split series, by connecting ventilation device to CnT of the indoor printed circuit board (in case of VRF series, by connecting it to CnD of the indoor printed circuit board), the operation of ventilation device is linked with the operation of indoor unit.
	VENT LINK	○ In case of Single split series, by connecting ventilation device to CnT of the indoor printed circuit board (in case of VRF series, by connecting it to CnD of the indoor printed circuit board), you can operate /stop the ventilation device independently by (VENT) button.
	NO VENT LINK	○
12 TEMP RANGE SET	INDOOR CHANGE	○ If you change the range of set temperature, the indication of set temperature will vary following the control.
	NO INDOOR CHANGE	○ If you change the range of set temperature, the indication of set temperature will not vary following the control, and keep the set temperature.
13 FAN FAN	HI-HLD-LO	※ Air flow of fan becomes of or the four speed of .
	HI-LO	※ Air flow of fan becomes of .
	HI-HLD	※ Air flow of fan becomes of .
	1 FAN SPEED	※ Air flow of fan is fixed at one speed.
◇ 14 POSITION	POSITION STOP	○ If you change the remote control function "14 POSITION", you must change the indoor function "04 POSITION" accordingly. You can select the louver stop position in the four.
	FREE STOP	○ The louver can stop at any position.
15 MODEL TYPE	HEAT PUMP	※
	COOLING ONLY	※
16 EXTERNAL CONTROL SET	INDIVIDUAL	○ If you input signal into CnT of the indoor printed circuit board from external, the indoor unit will be operated independently according to the input from external.
	FOR ALL UNITS	○ If you input into CnT of the indoor printed circuit board from external, all units which connect to the same remote control are operated according to the input from external.
17 ROOM TEMP INDICATION SET	INDICATION OFF	○ In normal working indication, indoor unit temperature is indicated instead of air flow.
	INDICATION ON	○ (Only the master remote control can be indicated.)
18 INDICATION	INDICATION ON	○ Heating preparation indication should not be indicated.
	INDICATION OFF	○
19 °F SET	°C	○ Temperature indication is by degree C
	°F	○ Temperature indication is by degree F

To next page

Notes (1) * The mark cannot use SRK series.
 (2) ◇ The mark cannot use SRR series.
 (3) ◆ The mark cannot use SRF series.

[ON/OFF] button (finished)

Note 1: The initial setting marked "※" is decided by connected indoor and outdoor unit, and is automatically defined as following table.

Function No.	Item	Default	Model
Remote control function02	AUTO RUN SET	AUTO RUN ON	"Auto-RUN" mode selectable indoor unit.
		AUTO RUN OFF	Indoor unit without "Auto-RUN" mode
Remote control function06	FAN SPEED SW	INVALID	Indoor unit with two or three step of air flow setting
		INVALID	Indoor unit with only one of air flow setting
Remote control function07	LOUVER SW	VALID	Indoor unit with automatically swing louver
		INVALID	Indoor unit without automatically swing louver
Remote control function13	I/U FAN	HI-MED-LO	Indoor unit with three step of air flow setting
		HI-LO	Indoor unit with two step of air flow setting
		1 FAN SPEED	Indoor unit with only one of air flow setting
Remote control function15	MODEL TYPE	HEAT PUMP	Heat pump unit
		COOLING ONLY	Exclusive cooling unit

Note 3: As for plural indoor unit, set indoor functions to each master and slave indoor unit.
 But only master indoor unit is received the setting change of indoor unit function "05 EXTERNAL INPUT" and "06 PERMISSION / PROHIBITION".

From previous page

Indoor unit No. are indicated only when plural indoor units are connected.

To set other indoor unit, press [AIR CON No.] button, which allows you to go back to the indoor unit selection screen (for example: I/U 000 ▲).

Function	setting	
*02 FAN SPEED SET	STANDARD	※
	HIGH SPEED 1	※
	HIGH SPEED 2	
*03 FILTER SIGN SET	INDICATION OFF	
	TYPE 1	○
	TYPE 2	
	TYPE 3	
	TYPE 4	
04 POSITION	POSITION STOP	○
	FREE STOP	
05 EXTERNAL INPUT	LEVEL INPUT	○
	PULSE INPUT	
06 PERMISSION/PROHIBITION	INVALID	○
	VALID	
*07 EMERGENCY STOP	INVALID	○
	VALID	
*08 ※ SP OFFSET	OFFSET +3.0c	
	OFFSET +2.0c	
	OFFSET +1.0c	○
	NO OFFSET	
*09 RETURN AIR TEMP	OFFSET +2.0c	
	OFFSET +1.5c	
	OFFSET +1.0c	○
	NO OFFSET	
	OFFSET -1.0c	
	OFFSET -1.5c	
	OFFSET -2.0c	
*10 ※ FAN CONTROL	LOW FAN SPEED	○
	SET FAN SPEED	
	INTERMITTENCE	
	FAN OFF	
*11 FROST PREVENTION TEMP	TEMP HIGH	
	TEMP LOW	○
*12 FROST PREVENTION CONTROL	FAN CONTROL ON	○
	FAN CONTROL OFF	
*13 DRAIN PUMP LINK	※○	○
	※○AND※	
	※○AND※AND※	
	※○AND※	
*14 ※ FAN REMAINING	NO REMAINING	○
	0.5 HOUR	
	1 HOUR	
	6 HOUR	
*15 ※ FAN REMAINING	NO REMAINING	○
	0.5 HOUR	
	2 HOUR	
	6 HOUR	
*16 ※ FAN INTERMITTENCE	NO REMAINING	○
	2min OFF 5min ON	
	5min OFF 5min ON	
*17 PRESSURE CONTROL	STANDARD	※
	TYPE 1	※

Note2: Fan setting of "HIGH SPEED"

Fan tap	Indoor unit air flow setting				
	UH - Hi - Me - Lo	Hi - Me - Lo	Hi - Lo	Hi - Me	
FAN SPEED SET	STANDARD	UH - Hi - Me - Lo	Hi - Me - Lo	Hi - Lo	Hi - Me
	HIGH SPEED1, 2	UH - UH - Hi - Me	UH - Hi - Me	UH - Me	UH - Hi

Initial function setting of some indoor unit is "HIGH SPEED".
 4 speed is not able to be set with wireless remote control.

The filter sign is indicated after running for 180 hours.
 The filter sign is indicated after running for 600 hours.
 The filter sign is indicated after running for 1000 hours.
 The filter sign is indicated after running for 1000 hours, then the indoor unit will be stopped by compulsion after 24 hours.
 If you change the indoor function "04 POSITION", you must change the remote control function "14 POSITION" accordingly.
 You can select the lower stop position in the four.
 The louver can stop at any position.
 Permission/prohibition control of operation will be valid.
 With the VRF series, it is used to stop all indoor units connected with the same outdoor unit immediately.
 When stop signal is input from remote on-off terminal "CnT-6", all indoor units are stopped immediately.

To be reset for producing +3.0 C increase in temperature during heating.
 To be reset for producing +2.0 C increase in temperature during heating.
 To be reset for producing +1.0 C increase in temperature during heating.
 To be reset producing +2.0 C increase in return air temperature of indoor unit.
 To be reset producing +1.5 C increase in return air temperature of indoor unit.
 To be reset producing +1.0 C increase in return air temperature of indoor unit.
 To be reset producing -1.0 C increase in return air temperature of indoor unit.
 To be reset producing -1.5 C increase in return air temperature of indoor unit.
 To be reset producing -2.0 C increase in return air temperature of indoor unit.

When heating thermostat is OFF, fan speed is low speed.
 When heating thermostat is OFF, fan speed is set speed.
 When heating thermostat is OFF, fan speed is operated intermittently.
 When heating thermostat is OFF, the fan is stopped.
 When the remote sensor is working, "FAN OFF" is set automatically.
 Do not set "FAN OFF" when the indoor unit's sensor is working.

Change of indoor heat exchanger temperature to start frost prevention control.
 Working only with the single split series.
 To control frost prevention, the indoor fan tap is raised.

Drain pump is run during cooling and dry.
 Drain pump is run during cooling, dry and heating.
 Drain pump is run during cooling, dry, heating and fan.
 Drain pump is run during cooling, dry and fan.

After cooling is stopped, the fan does not perform extra operation.
 After cooling is stopped, the fan perform extra operation for half an hour.
 After cooling is stopped, the fan perform extra operation for an hour.
 After cooling is stopped, the fan perform extra operation for six hours.
 After heating is stopped or heating thermostat is OFF, the fan does not perform extra operation.
 After heating is stopped or heating thermostat is OFF, the fan perform extra operation for half an hour.
 After heating is stopped or heating thermostat is OFF, the fan perform extra operation for two hours.
 After heating is stopped or heating thermostat is OFF, the fan perform extra operation for six hours.

During heating is stopped or heating thermostat is OFF, the fan perform intermittent operation for five minutes with low fan speed after twenty minutes' OFF.
 During heating is stopped or heating thermostat is OFF, the fan perform intermittent operation for five minutes with low fan speed after five minutes' OFF.

Connected "OA Processing" type indoor unit, and is automatically defined.

From previous page

Note (1) * The mark cannot use SRK, SRR and SRF series.

How to set function

1. Stop air-conditioner and press (SET) (MODE) buttons at the same time for over three seconds, and the "FUNCTION SET ▼" will be displayed.



2. Press (SET) button.
3. Make sure which do you want to set, "FUNCTION ▼" (remote control function) or "I/U FUNCTION ▲" (indoor unit function).
4. Press or button.
Select "FUNCTION ▼" (remote control function) or "I/U FUNCTION ▲" (indoor unit function).

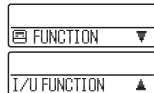

5. Press (SET) button.

6. 【On the occasion of remote control function selection】

- ① "DATA LOADING" (Indication with blinking)

↓
Display is changed to "01 EXP SET".

- ② Press or button.
"No. and function" are indicated by turns on the remote control function table, then you can select from them.
(For example)

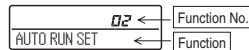

- ③ Press (SET) button.
The current setting of selected function is indicated.
(for example) "AUTO RUN ON" ← If "02 AUTO RUN SET" is selected

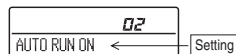

- ④ Press or button.
Select the setting.

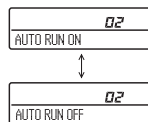

- ⑤ Press (SET)
"SET COMPLETE" will be indicated, and the setting will be completed.
Then after "No. and function" indication returns, Set as the same procedure if you want to set continuously, and if to finish, go to 7.



7. Press (ON/OFF) button.
Setting is finished.

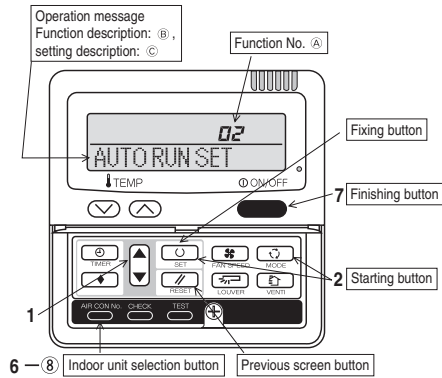

【On the occasion of indoor unit function selection】

- ① "DATA LOADING" (Blinking for 2 to 23 seconds to read the data)

↓
Indication is changed to "02 FAN SPEED SET".
Go to ②.

【Note】

- (1) If plural indoor units are connected to a remote control, the indication is "I/U 000" (blinking) ← The lowest number of the indoor unit connected is indicated.

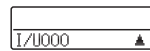

- (2) Press or button.
Select the number of the indoor unit you are to set
If you select "ALL UNIT ▼", you can set the same setting with all unites.
- (3) Press (SET) button.

- ② Press or button.
"No. and function" are indicated by turns on the indoor unit function table, then you can select from them.
(For example)

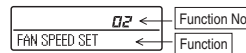

- ③ Press (SET) button.
The current setting of selected function is indicated.
(For example) "STANDARD" ← If "02 FAN SPEED SET" is selected.

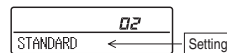

- ④ Press or button.
Select the setting.

- ⑤ Press (SET) button.
"SET COMPLETE" will be indicated, and the setting will be completed.
Then after "No. and function" indication returns, set as the same procedure if you want to set continuously, and if to finish, go to 7.



※ When plural indoor units are connected to a remote control, press the (AIR CON No.) button, which allows you to go back to the indoor unit selection screen. (example "I/U 000 ▲")

- It is possible to finish by pressing (ON/OFF) button on the way, but unfinished change of setting is unavailable.
- During setting, if you press (RESET) button, you return to the previous screen.
- Setting is memorized in the control and it is saved independently of power failure.

【How to check the current setting】

When you select from "No. and function" and press set button by the previous operation, the "Setting" displayed first is the current setting.
(But, if you select "ALL UNIT ▼", the setting of the lowest number indoor unit is displayed.)

8.2 Simple wired remote control (RCH-E3)

PJZ000Z272

Names and functions of sections

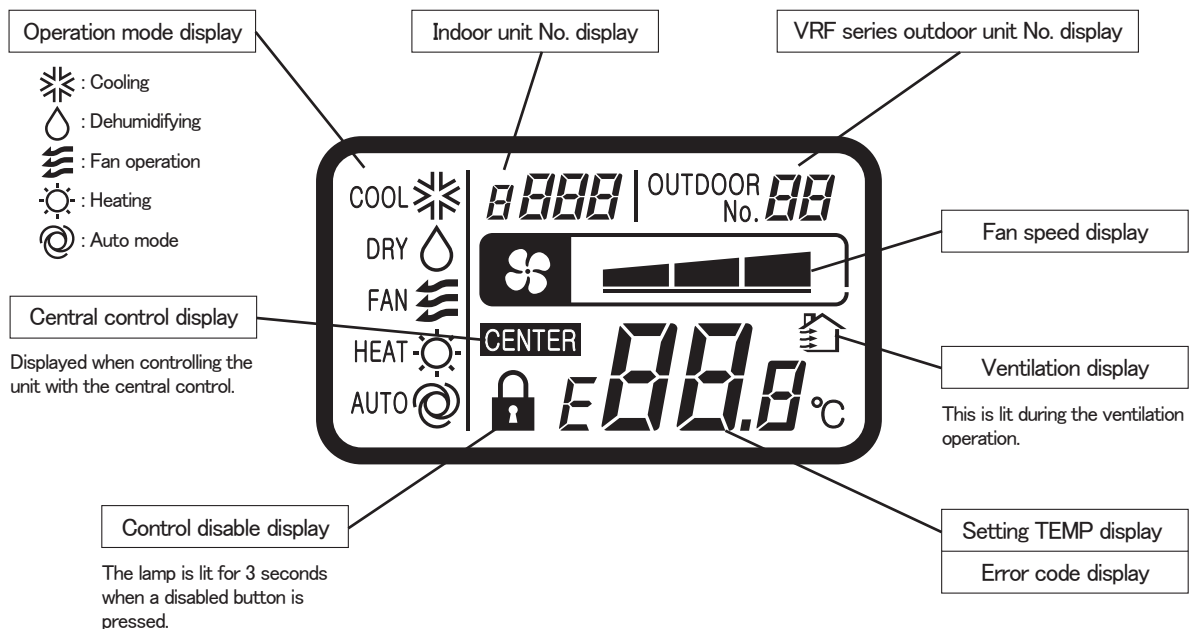
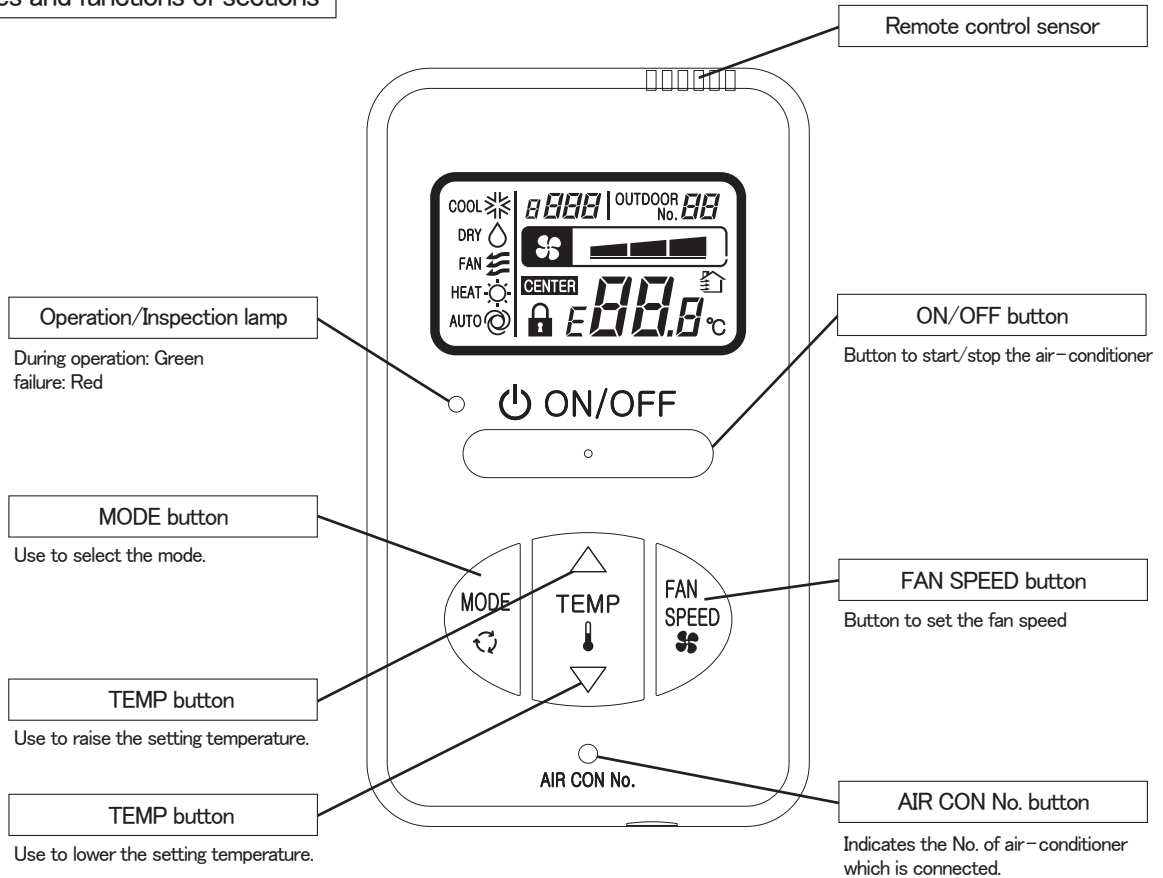

Installation of remote control

Do not install the remote control at the following places in order to avoid malfunction.

- (1) Places exposed to direct sunlight
- (2) Places near heat devices
- (3) High humidity places
- (4) Hot surface or cold surface enough to generate condensation
- (5) Places exposed to oil mist or steam directly
- (6) Uneven surface

Remote control installation dimensions

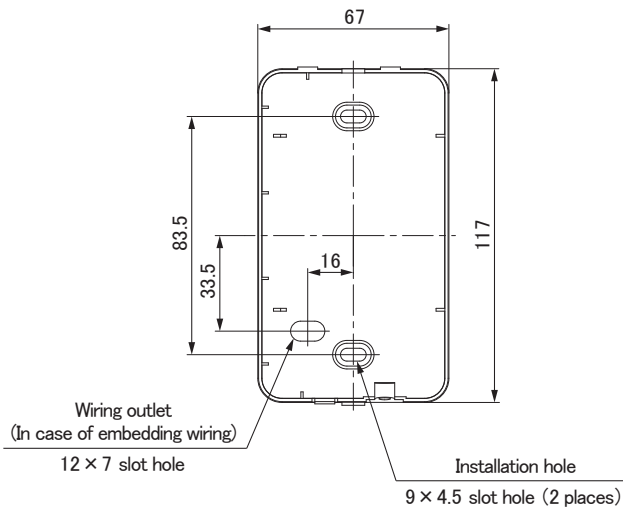

Note: Installation screw for remote control
M4 screw (2 pieces)

In case of embedding wiring

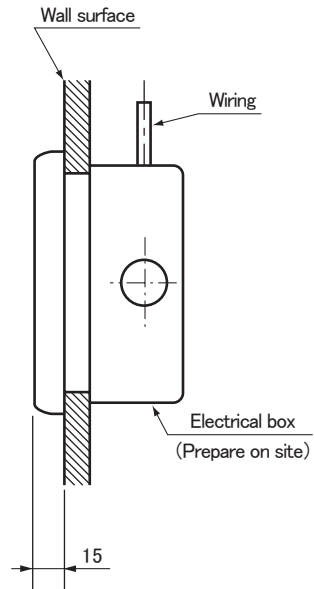

In case of exposing wiring

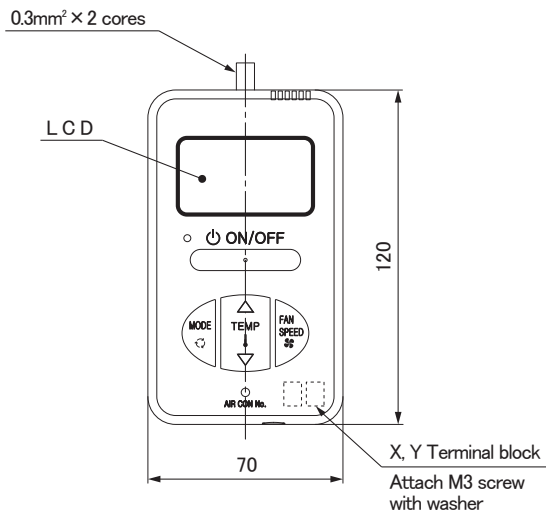

The remote control wiring can be extracted from the upper center. After the thin part in the upper side of the remote control upper case is scraped with a nipper or knife, remove burr with a file.

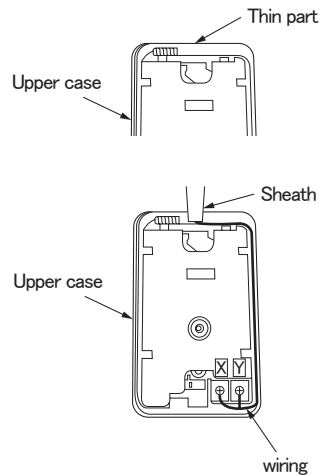

The peeling length of each wiring is as follows:

- X wiring : 160mm
- Y wiring : 150mm

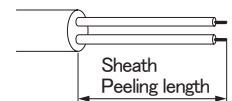

Wiring specifications

- (1) Wiring of remote control should use 0.3mm² × 2 cores wires or cables. (on-site configuration)
- (2) Maximum prolongation of remote control wiring is 600m.
If the prolongation is over 100m, change to the size below.
But, the wiring in the remote control case should be 0.3mm² (recommended) to 0.5mm².
Change the wire size outside of the case according to wire connecting. Waterproof treatment is necessary at the wire connecting section. Be careful about contact failure.

Length	Wiring thickness
100 to 200m	0.5mm ² × 2 cores
Under 300m	0.75mm ² × 2 cores
Under 400m	1.25mm ² × 2 cores
Under 600m	2.0mm ² × 2 cores

Unit:mm



Adapted to **RoHS** directive

Simple Remote Control Installation Manual

PJZ012D069 ⚠

Read together with indoor unit's installation manual.



⚠ WARNING

- **Fasten the wiring to the terminal securely and hold the cable securely so as not to apply unexpected stress on the terminal.**
Loose connection or hold will cause abnormal heat generation or fire. 
- **Make sure the power source is turned off when electric wiring work.**
Otherwise, electric shock, malfunction and improper running may occur. 

⚠ CAUTION

- **Do not install the remote control at the following places in order to avoid malfunction.**

(1) Places exposed to direct sunlight	(4) Hot surface or cold surface enough to generate condensation
(2) Places near heat devices	(5) Places exposed to oil mist or steam directly
(3) High humidity places	(6) Uneven surface

- **Do not leave the remote control without the upper case.**
In case the upper case needs to be detached, protect the remote control with a packaging box or bag in order to keep it away from water and dust. 



Accessories	Remote control, wood screw (φ 3.5 × 16) 2 pieces
Prepare on site	Remote control cord (2 cores) (Refer to [2. Installation and wiring of remote control]) [In case of embedding cord] Electrical box, M4 screw (2 pieces) [In case of exposing cord] Cord clamp (if needed)

1. Installation procedure

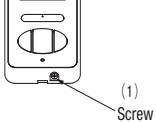
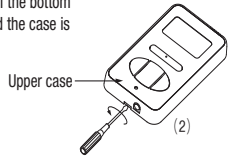
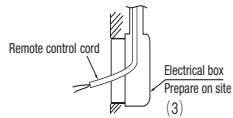
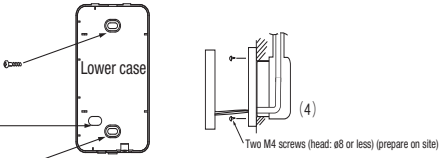
In case of embedding cord

- (1) **Make certain to remove** the screw on the bottom surface of the remote control. 
- (2) Remove the upper case of the remote control.
Insert a flat-blade screwdriver to a concave portion of the bottom surface of the remote control and slightly twist it, and the case is removed. 
- (3) Pre-bury the electrical box and remote control cord. 
- (4) Prepare two M4 screws (recommended length: 12 – 16mm), and install the lower case to the electrical box. Do not use a screw whose screw head is larger than the height of the wall around the screw hole. 
- (5) Connect the remote control cord to the terminal block.
Connect the terminals (X and Y) of the remote control and the terminals (X and Y) of the indoor unit. (No polarity of X and Y)
- (6) Mount the upper case for restoring to its former state so as not to crimp the remote control cord, and secure with the removed screw.

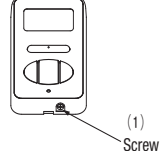
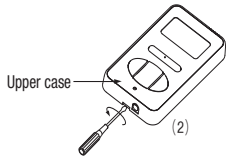
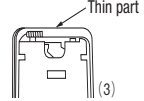
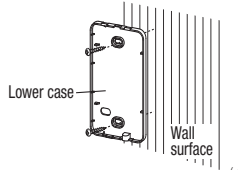
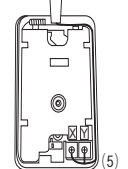
In case of exposing cord

- (1) **Make certain to remove** a screw on the bottom surface of the remote control. 
 - (2) Remove the upper case of the remote control.
Insert a flat-blade screwdriver to a concave portion of the bottom surface of the remote control and slightly twist it, and the case is removed. 
 - (3) The remote control cord can be extracted from the upper center.
After the thin part in the upper side of the remote control upper case is scraped with a nipper or knife, remove burr with a file. 
 - (4) The lower case of the remote control is mounted to a flat wall with two accessory wood screws. 
 - (5) Connect the remote control cord to the terminal block.
Connect the terminals (X and Y) of the remote control and the terminals (X and Y) of the indoor unit. (No polarity of X and Y)
The wiring route is as shown in the right. 
- The wiring in the remote control case should be 0.3 mm² (recommended) to 0.5 mm² at maximum.
Further, peel off the sheath.
The peeling length of each wiring is as follows:
- | |
|------------------|
| X wiring : 160mm |
| Y wiring : 150mm |
- 
- (6) Mount the upper case for restoring to its former state so as not to crimp the remote control cord, and secure with the removed screw.
 - (7) In the case of exposing installation, secure the remote control cord to the wall surface with a cord clamp so as not to loosen the remote control cord.

2. Installation and wiring of remote control

- (1) Wiring of remote control should use 0.3mm² × 2 cores wires or cables. (on-site configuration)
- (2) Maximum prolongation of remote control wiring is 600 m.
If the prolongation is over 100m, change to the size below.
But, the wiring in the remote control case should be 0.3mm² (recommended) to 0.5mm².
Change the wire size outside of the case according to wire connecting. Waterproof treatment is necessary at the wire connecting section. Be careful about contact failure.

100 - 200m	· · · · ·	0.5mm ² × 2 cores
Under 300m	· · · · ·	0.75mm ² × 2 cores
Under 400m	· · · · ·	1.25mm ² × 2 cores
Under 600m	· · · · ·	2.0mm ² × 2 cores

3. Master/ slave setting when more than one remote control are used

- (1) Up to two remote controls can be connected to one unit (or one group) of indoor unit.

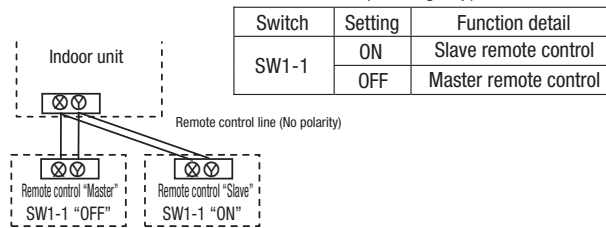

- (2) Set the switch SW1-1 of the slave remote control is "Slave" (ON). The factory default is set as "Master" (OFF).

- (Note) • The remote control thermistor enabled setting can be set only to the master remote control.
- Install the master remote control at the position to detect room temperature.
 - The air-conditioner operation follows the last operation of the remote control in case of the master / slave setting.

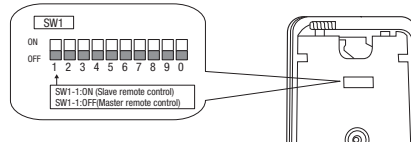

4. The indication when power source is supplied

- (1) At the time of turning the power source on, after the light is on for the first 2 seconds, the display becomes as shown below.

The number displayed on the upper side of LCD in the remote control is the software number, and this is not an error code.

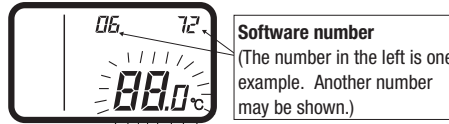

- (2) Then, "88.0 °C" blinks on the remote control until the communication between the remote control and the indoor unit is established.
- (3) In the case of connecting one remote control with one unit (or one group) of indoor unit, make certain to set the master remote control (factory default). If the slave remote control is set, a communication cannot be established.
- (4) If a state where the communication between the remote control and the indoor unit cannot be established continues about for 30 minutes, "E" is displayed. Confirm the wiring of the indoor unit and the outdoor unit and master/slave setting of the remote control.



5. Confirmation method for return air temperature

Return air temperature can be confirmed by the remote control operation.

- (1) Press **AIR CON No.** button for over 5 seconds.

"88" blinks on the temperature setting indicator.
("88" blinks for approximately 2 seconds while data are read.)



Then, the return air temperature is displayed.

(Example) return air temperature: "27 °C" (blinking)

(Note) For the return air temperature, in the normal case, the return air temperature of the indoor unit is displayed; however, in the case that the remote control thermistor is effective, detected temperature by the remote control thermistor is displayed.

- (2) Press **ON/OFF** button.
End.

[In the case that the remote thermistor is ineffective and plural indoor units are connected to one remote control]

- (1) Press **AIR CON No.** button for over 5 seconds.

Indoor unit No. indicator: "U 000" (blinking)
(Among the connected indoor units, the lowest number is displayed.)

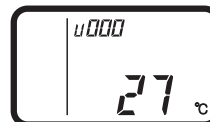

- (2) Press **TEMP** or **TEMP** button.

Select the indoor unit No.

- (3) Press **MODE** button.

Decider the indoor unit No.

(Example) Indoor unit No. indicator: "U 000"

"88" blinks on the temperature setting indicator. (blinking for approximately 2 to 10 seconds while data are read) Then, the return air temperature is displayed. When **AIR CON No.** is pressed, return to the indoor unit selection display (example, "U 000").

- (4) Press **ON/OFF** button.
End.

6. Function setting

Each function of the remote control and the indoor unit is automatically set to the initial setting, which is the standard use, on the occasion of connecting the remote control with the indoor unit. In the case of the standard use, the setting change is unnecessary. However, if you would like to change the initial setting "○", change the setting for only the item of the function number. **Record the setting contents and stored them.**

(1) Function setting item by switch on PCB

Switch No.	Setting	Setting detail	Initial setting
SW1-1	ON	Slave remote control	
	OFF	Master remote control	○
SW1-2	ON	Remote control thermistor enabled	
	OFF	Remote control thermistor disabled	○
SW1-3	ON	"MODE" button prohibited	
	OFF	"MODE" button enabled	○
SW1-4	ON	"ON/OFF" button prohibited	
	OFF	"ON/OFF" button enabled	○

Switch No.	Setting	Setting detail	Initial setting
SW1-5	ON	"TEMP" button prohibited	
	OFF	"TEMP" button enabled	○
SW1-6	ON	"FAN SPEED" button prohibited	※ Note 1
	OFF	"FAN SPEED" button enabled	※ Note 1
SW1-7	ON	Auto restart function enabled	
	OFF	Auto restart function disabled	○
SW1-8, 9, 0	ON	Not used	
	OFF	Not used	

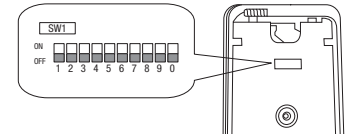

- As for the slave remote control, function setting is impossible other than SW1-1.
- In the indoor unit with only one fan speed, "FAN SPEED" button cannot be enabled.

(2) Function setting item by button operation

Classification	Function No.	Function	Setting No.	Setting	Initial setting	Remarks
Remote control function	01	Indoor unit fan speed	01	Fan speed: three steps	※ Note 1	The fan speed is three steps, ☼■●-☼■●-☼■● .
			02	Fan speed: two steps (Hi-Lo)	※ Note 1	The fan speed is two steps, ☼■●-☼■● .
			03	Fan speed: two steps (Hi-Me)		The fan speed is two steps, ☼■●-☼■● .
			04	Fan: one step	※ Note 1	The fan speed is fixed to one step.
	03	Remote control thermistor at the time of cooling	01	Remote control thermistor: no offset	○	
			02	Remote control thermistor: +3.0 °C		At the time of cooling, in the case of remote control thermistor enabled, offset temperature at +3.0°C.
			03	Remote control thermistor: +2.0 °C		At the time of cooling, in the case of remote control thermistor enabled, offset temperature at +2.0°C.
			04	Remote control thermistor: +1.0 °C		At the time of cooling, in the case of remote control thermistor enabled, offset temperature at +1.0°C.
			05	Remote control thermistor: -1.0 °C		At the time of cooling, in the case of remote control thermistor enabled, offset temperature at -1.0°C.
			06	Remote control thermistor: -2.0 °C		At the time of cooling, in the case of remote control thermistor enabled, offset temperature at -2.0°C.
			07	Remote control thermistor: -3.0 °C		At the time of cooling, in the case of remote control thermistor enabled, offset temperature at -3.0°C.
	04	Remote control thermistor at the time of heating	01	Remote control thermistor: no offset	○	
			02	Remote control thermistor: +3.0 °C		At the time of heating, in the case of remote control thermistor enabled, offset temperature at +3.0°C.
			03	Remote control thermistor: +2.0 °C		At the time of heating, in the case of remote control thermistor enabled, offset temperature at +2.0°C.
04			Remote control thermistor: +1.0 °C		At the time of heating, in the case of remote control thermistor enabled, offset temperature at +1.0°C.	
05			Remote control thermistor: -1.0 °C		At the time of heating, in the case of remote control thermistor enabled, offset temperature at -1.0°C.	
06			Remote control thermistor: -2.0 °C		At the time of heating, in the case of remote control thermistor enabled, offset temperature at -2.0°C.	
07			Remote control thermistor: -3.0 °C		At the time of heating, in the case of remote control thermistor enabled, offset temperature at -3.0°C.	
05	Ventilation setting	01	No ventilator connection	○		
		02	Ventilator links air-conditioner		In case of Single split series, by connecting ventilation device to CnT of the indoor printed circuit board (in case of VRF series, by connecting it to CnD of the indoor printed circuit board), the operation of ventilation device is linked with the operation of indoor unit.	
06	"Auto" operation setting	01	"Auto" operation enabled	※ Note 1		
		02	"Auto" operation disabled	※ Note 1	"Auto" operation disabled	
Indoor unit function	07	Operation permission/prohibition	01	Disabled	○	
			02	Enabled		Operation permission/prohibition control is enabled.
	08	External input	01	Level input	○	
			02	Pulse input		
	09	Fan speed setting	01	Standard	Note2	
			02	High speed 1	Note2	
			03	High speed 2	Note2	
	10	Fan remaining operation at the time of cooling	01	No remaining operation	○	After cooling stopped, no fan remaining operation
			02	0.5 hours		After cooling stopped, fan remaining operation for 0.5 hours
			03	1 hour		After cooling stopped, fan remaining operation for 1 hour
			04	6 hours		After cooling stopped, fan remaining operation for 6 hours
	11	Fan remaining operation at the time of heating	01	No remaining operation	○	After heating stopped or after heating thermostat OFF, no fan remaining operation
			02	0.5 hours		After heating stopped or after heating thermostat OFF, fan remaining operation for 0.5 hours
			03	2 hours		After heating stopped or after heating thermostat OFF, fan remaining operation for 2 hours
04			6 hours		After heating stopped or after heating thermostat OFF, fan remaining operation for 6 hours	
12	Setting temperature offset at the time of heating	01	No offset	○		
		02	Setting temperature offset + 3.0 °C		The setting temperature at the time of heating is offset by +3.0 °C.	
		03	Setting temperature offset + 2.0 °C		The setting temperature at the time of heating is offset by +2.0 °C.	
		04	Setting temperature offset + 1.0 °C		The setting temperature at the time of heating is offset by +1.0 °C.	
13	Heating fan controller	01	Low fan speed	※ Note 1	At the time of heating thermostat OFF, operate with low fan speed.	
		02	Setting fan speed		At the time of heating thermostat OFF, operate with the setting fan speed.	
		03	Intermittent operation	※ Note 1	At the time of heating thermostat OFF, intermittently operate.	
		04	Fan off		At the time of heating thermostat OFF, a fan will be stopped. When the remote control thermistor is enabled, automatically set to "Fan off". Do not set at the time of the indoor unit thermistor.	
14	Return air temperature offset	01	No offset	○		
		02	Return air temperature offset +2.0 °C		Offset the return air temperature of the indoor unit by +2.0 °C.	
		03	Return air temperature offset +1.5 °C		Offset the return air temperature of the indoor unit by +1.5 °C.	
		04	Return air temperature offset +1.0 °C		Offset the return air temperature of the indoor unit by +1.0 °C.	
		05	Return air temperature offset -1.0 °C		Offset the return air temperature of the indoor unit by -1.0 °C.	
		06	Return air temperature offset -1.5 °C		Offset the return air temperature of the indoor unit by -1.5 °C.	
		07	Return air temperature offset -2.0 °C		Offset the return air temperature of the indoor unit by -2.0 °C.	

Note 1: The symbol "※" in the initial setting varies depending upon the indoor unit and the outdoor unit to be connected, and this is automatically determined as follows.

Switch No. / Function No.	Function	Setting	Product model
SW1-6	"FAN SPEED" button	"FAN SPEED" button prohibited	Product model whose indoor fan speed is only one step
		"FAN SPEED" button enabled	Product model whose indoor fan speed is two steps or three steps
Remote control function 01	Indoor unit fan speed	Fan speed: three steps	Product model whose indoor unit fan speed is three steps
		Fan speed: two steps (Hi-Lo)	Product model whose indoor unit fan speed is two steps
		Fan: one step	Product model whose indoor unit fan speed is only one step
Remote control function 06	"Auto" operation setting	"Auto" operation enabled	Product model where "Auto" mode is selectable
		"Auto" operation disabled	Product model without "Auto" mode
Indoor unit function 13	Heating fan control	Low fan speed	Product model except FDUS
		Intermittent operation	FDUS

Note 2: Fan speed of "High speed" setting

Fan speed setting	Indoor unit fan speed setting		
Standard	☼■●-☼■●-☼■●	Hi - Lo	Hi - Mid
High speed 1・2	UHi - Hi - Mid	UHi - Mid	UHi - Hi

Initial setting of some indoor unit is "High speed".

Note 3: As for plural indoor unit, set indoor functions to each master and slave indoor unit. But only master indoor unit is received the setting change of indoor unit function "07 Operation permission/prohibition" and "08 External input".

7. How to set functions by button operation

- (1) Stop air-conditioning, and simultaneously press **AIR CON No.** and **MODE** buttons at the same time for over three seconds.
The function number "01" blinks in the upper right.

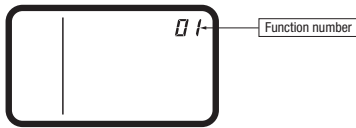

- (2) Press **TEMP▲** or **TEMP▼** button.
Select the function number.

- (3) Press **MODE** button.
Decide the function number.

- (4) [In the case of selecting the remote control function (01-06)]

- ① The current setting number of the selected function number blinks (Example)
Function number: "01" (lighting)
Setting number: "01" (blinking)

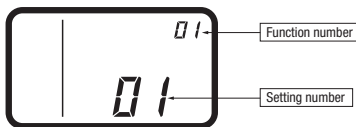

- ② Press **TEMP▲** or **TEMP▼** button.
Select the setting number.

- ③ Press **MODE** button.

The setting is completed.

Light is on for approximately 3 to 20 seconds while data of the decided function No. and setting No. is transmitted.

(Example)

Function number: "01" (lighting for 3 to 20 seconds)
Setting number: "01" (lighting for 3 to 20 seconds)

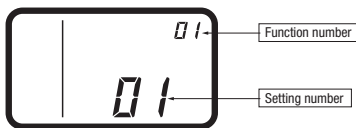

Then, the screen goes back to the function number blinking indication (1), if the setting is sequentially conducted, continue with the same procedures. If the setting is finished, proceed to (5).

- (5) Press **ON/OFF** button.
The setting is completed.

- Even if **ON/OFF** button is pressed during setting, the setting is ended. However, any details where the setting has not been completed will be ineffective.
- The setting contents are stored in the control, and even if the power failure occur, this will not be lost.

[Confirmation method for current setting]

According to the operation, the "setting number" displayed first after selecting "function number" and pressing **MODE** button is the currently set content. (However, in the case of selecting "U ALL" (all units), the setting number of the lowest number among the indoor units is displayed.)

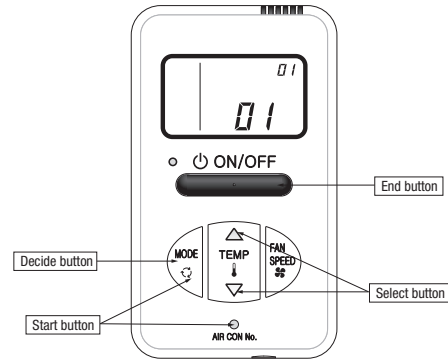

[In the case of selecting the indoor unit function (07-14)]

- ① "88" blinks on the temperature setting indicators.
(blinking for approximately 2 to 10 seconds while data are read)



After that, the current setting number of the selected function number blinks. (Example)

Function number: "07" (lighting)
Setting number: "01" (blinking)

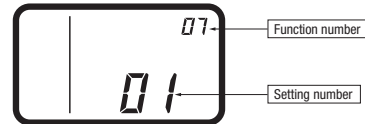

Proceed to ②.

[Note]

- a. In the case of connecting one remote control to plural indoor units, the display will be as follows:

Indoor unit No. display: "U 000" (blinking)

(Display the lowest number among the connected indoor units.)

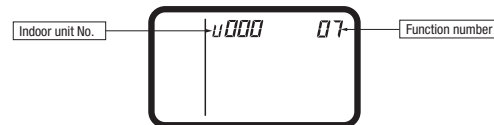

- b. Press **TEMP▲** or **TEMP▼** button.

Select the indoor unit No. to be set.

If "U ALL" is selected, the same setting can be set to all units.

- c. Press **MODE** button.

Decide the indoor unit No.

"88" blinks on the temperature setting indicators. (blinking for 2 to 10 seconds while data are read)

When **AIR CON No.** button is pressed, go back to the indoor unit selection display (for example, "U 000" blinking).

- ② Press **TEMP▲** or **TEMP▼** button.

Select the setting number

- ③ Press **MODE** button.

The setting is completed.

Light is on for approximately 3 to 20 seconds while data of the decided function No. and setting No. is transmitted.

(Example)

Indoor unit No.: "U 000" (lighting for 3 to 20 seconds)
Function number: "07" (lighting for 3 to 20 seconds)
Setting number: "01" (lighting for 3 to 20 seconds)

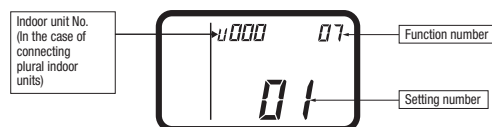

Then, the screen goes back to the function number blinking indication (1), if the setting is sequentially conducted, continue with the same procedures. If the setting is finished, proceed to (5).

8.3 Wireless kit

(1) FDC series (RCN-TC-5AW-E3)

(a) Specification

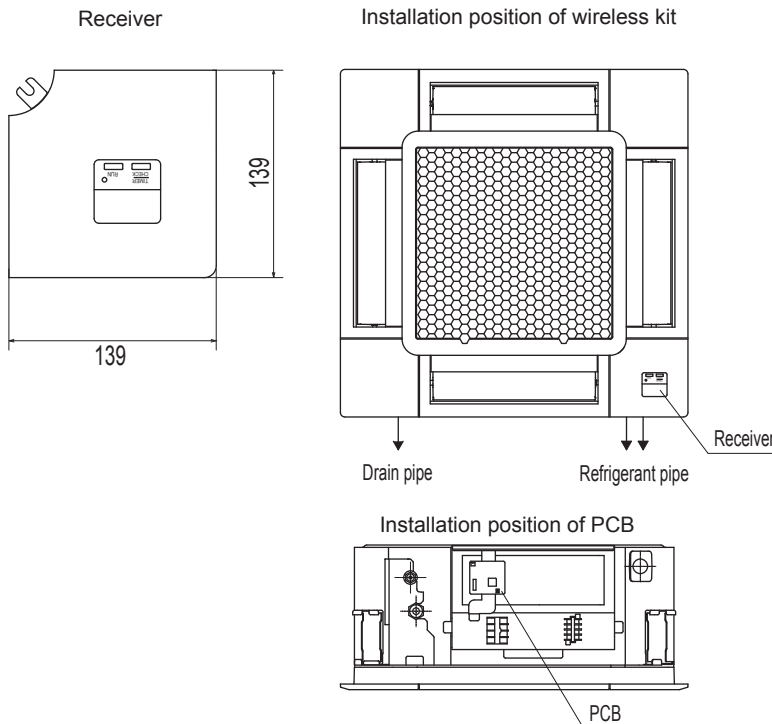

- Notes**
- (1) Receiver must be installed to the position as shown.
 - (2) Two LR03 AAA dry cell batteries for remote control are enclosed.
 - (3) See spec sheet of "Wireless remote control" about remote control.

Installation of wireless kit

Do not install the wireless kit at the following places in order to avoid malfunction.

- (1) Places exposed to direct sunlight
- (2) Places near heat-generating devices
- (3) High humidity places
- (4) Hot surface or cold surface enough to generate condensation
- (5) Places exposed to oil mist or steam directly
- (6) Uneven surface
- (7) Places affected by the direct airflow of the AC unit
- (8) Places where the receiver is influenced by fluorescent lamp or sunlight
- (9) Places where the receiver is affected by infrared rays of any other communication devices
- (10) Places where some object may obstruct the communication with the remote control

Setting switch on PCB

SW1	Prevents interference during multiple setting	ON: Normal OFF: Remote
SW2	Receiver master/slave setting	ON: Master OFF: Slave
SW3	Buzzer	ON: Valid OFF: Invalid
SW4	Auto restart	ON: Valid OFF: Invalid

Default setting: mark

Remote control

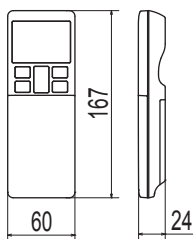

Remote control holder

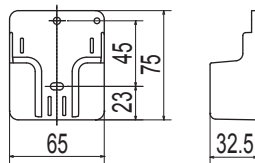

Wireless remote control's operable area

- ① Standard reachable area of the signal
[condition] Illuminance at the receiver: 300lux
(When no lighting is installed within 1m of the receiver in an ordinary office)

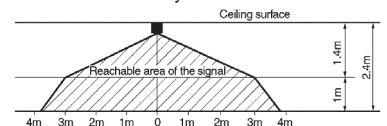

- ② Correlation between illuminance at the receiver and reachable area of the signal in a plain view.
The drawing in the right shows the correlation between the reachable area of the signal and illuminance at the receiver when the remote control is operated at 1m high under the condition of ceiling height of 2.4m.
When the illuminance becomes double, the area is narrowed down to two thirds.

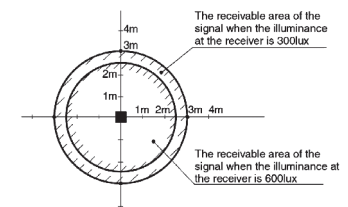

- ③ Installation tips when several receivers are installed close to one another minimum distance between the indoor units which can avoid cross communication is 5m under the condition of 300lux of illuminance at the receiver.
(When no lighting is installed within 1m of the receiver in an ordinary office)

Unit:mm

PJF000Z634

(b) Installation manual

PJF012D506B 

Safety precautions

• Please read this manual carefully before starting installation work to install the unit properly. All of the following are important information to be observed strictly.

 **WARNING** Failure to follow these instructions properly may result in serious consequences such as death, severe injury, etc.













 **CAUTION** Failure to follow these instructions properly may cause injury or property damage. It could have serious consequences depending on the circumstances.

• The following symbols are used in the text.

	Never do.		Always follow the instructions given.
---	-----------	---	---------------------------------------

• Keep this manual at a safe place where you can consult with whenever necessary. Show this manual to installers when moving or repairing the unit. When the ownership of the unit is transferred, this manual should be given to the new owner.

WARNING

-  • **Consult your dealer or a professional contractor to install the unit.**
Improper installation made on your own may cause electric shocks, fire or dropping of the unit.
-  • **Installation work should be performed properly according to this installation manual.**
Improper installation work may result in electric shocks, fire or break-down.
-  • **Be sure to use accessories and specified parts for installation work.**
Use of unspecified parts may result in drop, fire or electric shocks.
-  • **Install the unit properly to a place with sufficient strength to hold the weight.**
If the place is not strong enough, the unit may drop and cause injury.
-  • **Be sure to have the electrical wiring work done by qualified electrical installer, and use exclusive circuit.**
Power source with insufficient and improper work can cause electric shock and fire.
-  • **Shut OFF the main power source before starting electrical work.**
Otherwise, it could result in electric shocks, break-down or malfunction.
-  • **Do not modify the unit.**
It could cause electric shocks, fire, or break-down.
-  • **Be sure to turn OFF the power circuit breaker before repairing/inspecting the unit.**
Repairing/inspecting the unit with the power circuit breaker turned ON could cause electric shocks or injury.
-  • **Do not install the unit in appropriate environment or where inflammable gas could generate, flow in, accumulate or leak.**
If the unit is used at places where air contains dense oil mist, steam, organic solvent vapor, corrosive gas (ammonium, sulfuric compound, acid, etc) or where acidic or alkaline solution, special spray, etc. are used, it could cause electric shocks, break-down, smoke or fire as a result of significant deterioration of its performance or corrosion.
-  • **Do not install the unit where water vapor is generated excessively or condensation occurs.**
It could cause electric shocks, fire, or break-down.
-  • **Do not use the unit in a place where it gets wet, such as laundry room.**
It could cause electric shocks, fire, or break-down.
-  • **Do not operate the unit with wet hands.**
It could cause electric shocks.

⚠ WARNING



• **Do not wash the unit with water.**
It could cause electric shocks, fire, or break-down.



• **Use the specified cables for wiring, and connect them securely with care to protect electronic parts from external forces.**
Improper connections or fixing could cause heat generation, fire, etc.



• **When installing the unit at a hospital, telecommunication facility, etc., take measures to suppress electric noises.**
It could cause malfunction or break-down due to hazardous effects on the inverter, private power generator, high frequency medical equipment, radio communication equipment, etc. The influences transmitted from the remote control to medical or communication equipment could disrupt medical activities, video broadcasting or cause noise interference.



• **Do not leave the remote control with its PCB case removed.**
If dew, water, insect, etc. enter through the hole, it could cause electric shocks, fire or break-down.

⚠ CAUTION



• Do not install the wireless kit at the following places in order to avoid malfunction. It could cause break-down or deformation of remote control.

(1) Places exposed to direct sunlight	(8) Places where the receiver is influenced by fluorescent lamp (especially inverter type) or sunlight
(2) Places near heat-generating devices	(9) Places where the receiver is affected by infrared rays of any other communication devices
(3) High humidity places	(10) Places where some object may obstruct the communication with the remote control
(4) Hot surface or cold surface enough to generate condensation	
(5) Places exposed to oil mist or steam directly	
(6) Uneven surface	
(7) Places affected by the direct air flow of the AC unit	

① Accessories

Please make sure that you have all of the following accessories.

① Receiver		1	⑤ Bracket mounting screw		1	① Wireless remote control (RCN-E2)		1
② PCB		1	⑥ Wiring (For communication)		1	② Remote control holder		1
③ PCB mounting support		2	⑦ Wiring (For receiving)		1	③ Screw for holder		2
④ Bracket (Sheet metal)		1	⑧ Installation manual		1	④ AAA dry cell battery (LR03)		2
			⑨ Parts set		1	⑤ User's manual		1

② Preparation before installation

Setting of PCB

Accessory PCB has the following switches to set the functions. Default setting is shown with mark.

SW1	Prevents interference during multiple setting	<input type="checkbox"/> ON : Normal	<input type="checkbox"/> OFF : Remote
SW2	Receiver master/slave setting	<input type="checkbox"/> ON : Master	<input type="checkbox"/> OFF : Slave
SW3	Buzzer	<input type="checkbox"/> ON : Valid	<input type="checkbox"/> OFF : Invalid
SW4	Auto restart	<input type="checkbox"/> ON : Valid	<input type="checkbox"/> OFF : Invalid

② Preparation before installation (continued)

To change setting

1. Change the setting of switches on the accessory PCB.

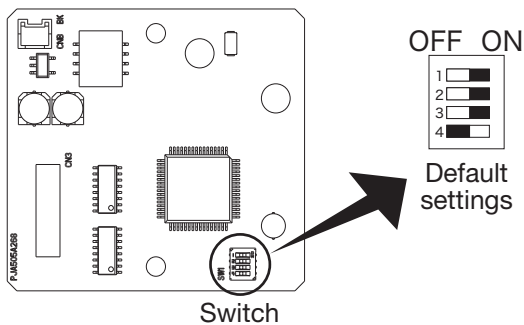

Master/Slave setting when using multiple remote controls

Up to two receivers or wired remote controls can be installed on one indoor unit group. In such occasion, it is necessary to change the setting to slave on either one.

To change the setting on the receiver, refer to the instruction manual of the receiver.

2. When SW1 is turned to OFF position, change the wireless remote control setting.

For the method of changing the setting, refer to **Setting to avoid mixed communication** of

④ Wireless remote control.

*For the receivable area of the signal, refer to **⑤ Receiver**.

③ How to install the receiver

It is possible to install the receiver by replacing the corner lid on the panel.

Preparation before installation

- ① Remove the inlet grille according to the installation manual of the panel.
- ② Remove the corner lid at the refrigerant pipe side.
- ③ Loosen screws (2 pcs.) on the control box of the unit.
- ④ Slide the control lid in the arrow direction, and remove it.

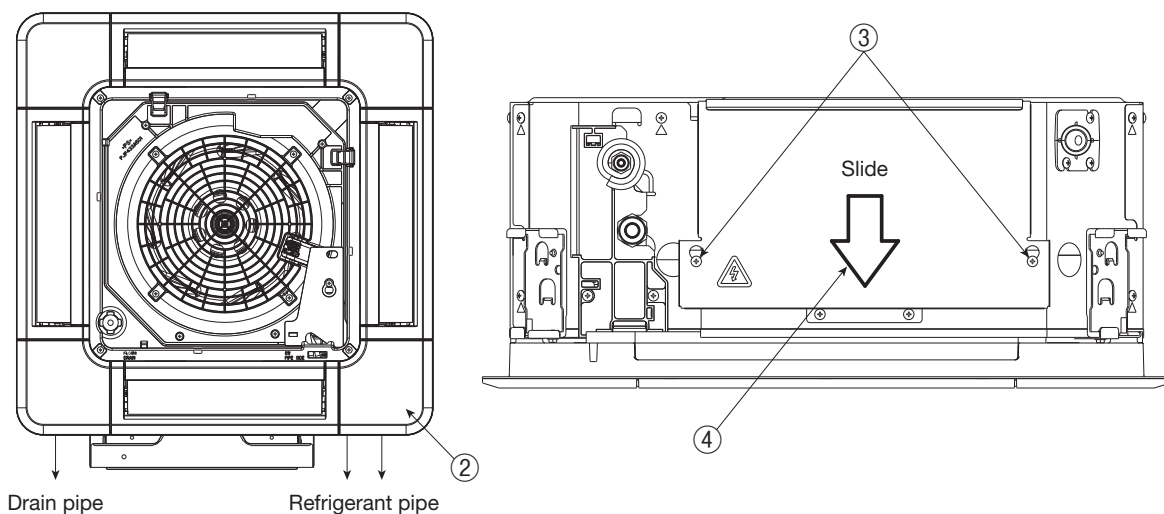

③ How to install the receiver(continued)

Installation of the receiver

- ① Connect the wire connector (Communication) to CNB on PCB.
- ② Connect the wire connector (Receiver) to CN3 on PCB.
- ③ Install the PCB mounting supports on the bracket (Sheet metal).
- ④ Install PCB on the PCB mounting supports.
- ⑤ Insert the bracket (Sheet metal) in one side of control box, and fix the other side with screws as shown in the figure.
- ⑥ Connect round terminals of wires (Communication) to the terminal block (X, Y) in the control box. The wires have no polarity.
- ⑦ Fix wires with bands as shown in the figure.
- ⑧ Cut off the half-blanks on the panel (at 4 places) as shown in the figure.
- ⑨ Pass the wiring (Communication) through the opening on the panel.
- ⑩ Connect connectors of the wiring (Communication) and the receiver.
- ⑪ Install the receiver on the panel according to the installation manual of the panel.
- ⑫ Install the control box lid with care not to pinch wires, and fix with screws (2 pcs.).

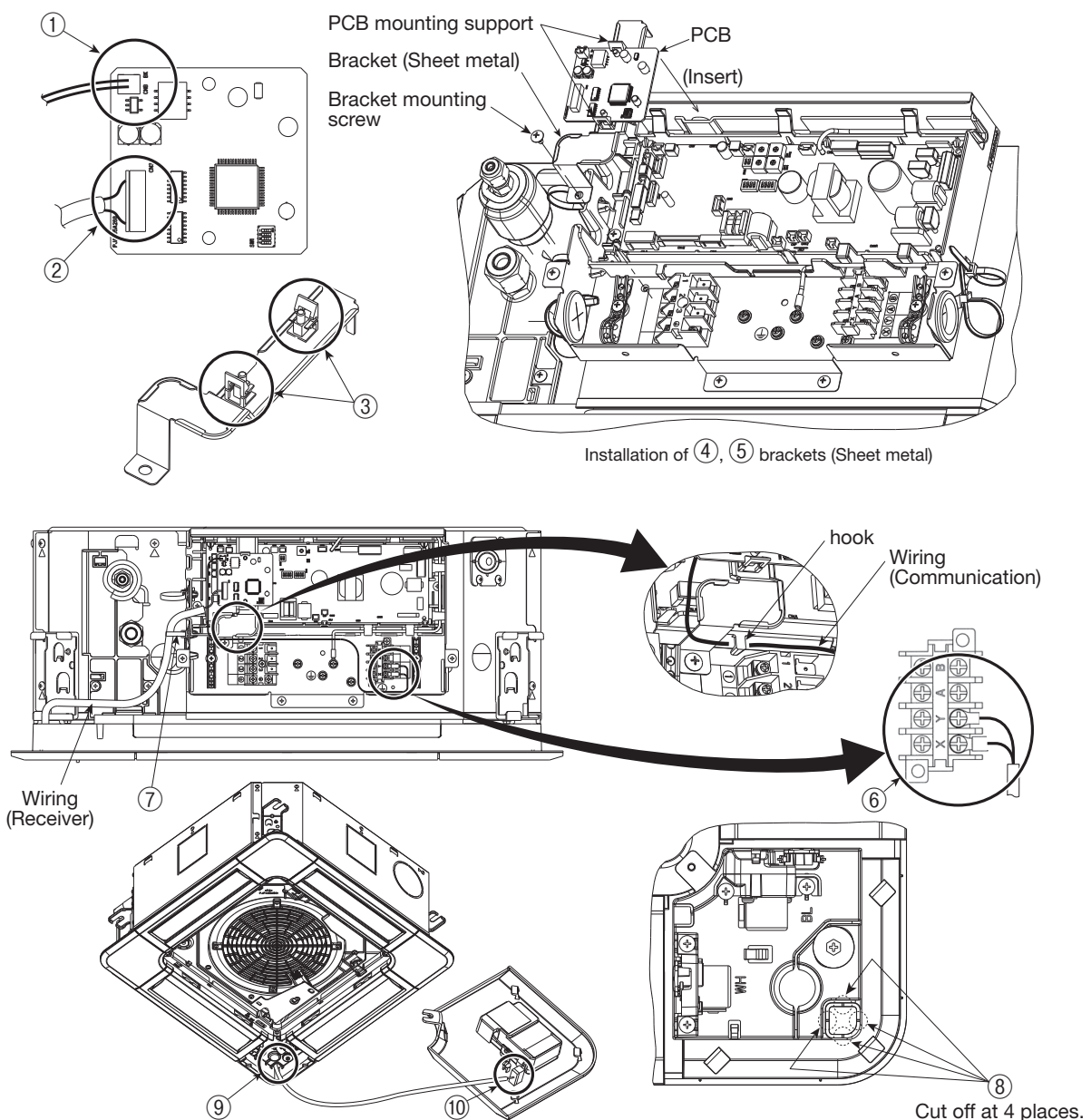

④ Wireless remote control

Installation tips for the remote control holder

Fix the remote control holder using the screws supplied with this product.

* Precautions for installing the holder

- Adjust the position so that it is upright.
- Ensure that the screw heads are not protruding.
- Do not attach the holder on plaster wall.

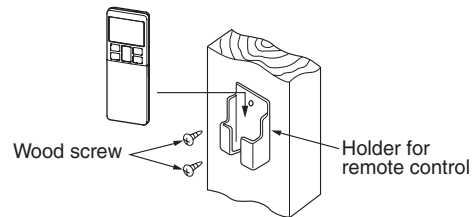

How to insert batteries

1. Detach the back lid.
2. Insert the batteries. (two AAA batteries)
3. Reattach the back lid.

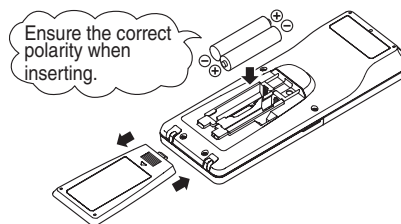

Setting to avoid mixed communication

1. Detach the back lid, and remove the batteries.
2. Cut off the switching wire in the battery compartment using nippers.
3. Insert the batteries, and attach the back lid.

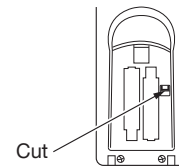

Changing the remote control setting

How to change the Auto Run setting

The Auto Run mode is not available on the building air-conditioning and gas heat pump series (excluding the cooling/heating free multi system).

When using the remote control to operate those models, set the remote control to disable the Auto Run mode.

To disable the Auto Run mode, press the **[ACL]** switch while holding down the **[MODE]** button, or insert batteries while holding down the **[MODE]** button.

* Note: Once the batteries are removed, the setting is reset to the factory default. When the batteries are removed, repeat the steps described above.

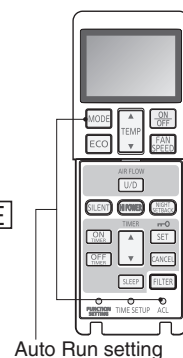

Indoor function settings

1. How to set indoor functions
 - ① Press the ON/OFF button to stop the unit.
 - ② Press the desired one of the buttons shown item 2. while holding down the FUNCTION SETTING switch.
 - ③ Use the selection buttons ▲ and ▼ to change the setting.
 - ④ Press the SET button.

The buzzer on the remote control signal receiver beeps twice, and the LED lamp flashes four times at two-second intervals.

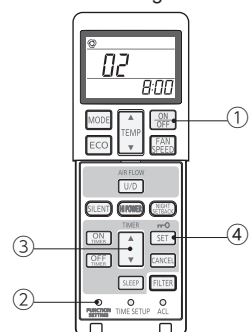

④ Wireless remote control (continued)

2. Setting details

The following functions can be set.

Button	Number indicator	Function setting
FAN SPEED	00	Fan speed setting : Standard
	01	Fan speed setting : Setting 1 *
	02	Fan speed setting : Setting 2 *
MODE	00	Room heating temperature adjustment : Disable
	01	Room heating temperature adjustment : +1°C
	02	Room heating temperature adjustment : +2°C
	03	Room heating temperature adjustment : +3°C
FILTER	00	Filter sign display : OFF
	01	Filter sign display : 180 hours
	02	Filter sign display : 600 hours
	03	Filter sign display : 1000 hours
	04	Filter sign display : Operation stop after 1000 hours have elapsed
U/D (Up/Down)	00	Anti draft setting : Disable
	01	Anti draft setting : Enable
SILENT	00	Infrared sensor setting (Motion sensor setting) : Disable
	01	Infrared sensor setting (Motion sensor setting) : Enable
HI POWER	00	Infrared sensor control (Motion sensor control) : Disable
	01	Infrared sensor control (Motion sensor control) : Power control only
	02	Infrared sensor control (Motion sensor control) : Auto OFF only
	03	Infrared sensor control (Motion sensor control) : Power control + Auto OFF
ON TIMER	00	Cooling fan residual-period running : Disable
	01	Cooling fan residual-period running : 0.5 hours
	02	Cooling fan residual-period running : 2 hours
	03	Cooling fan residual-period running : 6 hours
OFF TIMER	00	Heating fan residual-period running : Disable
	01	Heating fan residual-period running : 0.5 hours
	02	Heating fan residual-period running : 2 hours
	03	Heating fan residual-period running : 6 hours
NIGHT SETBACK	00	Remote control signal receiver LED : Brightness High
	01	Remote control signal receiver LED : Brightness Low
	02	Remote control signal receiver LED : OFF

* Refer to service manual.

5 Receiver

1 Control multiple indoor units with one remote control

Up to 16 indoor units can be connected.

1. Connect the XY terminal with 2 cores wire. As for the size, refer to the note on the right.
2. For Packaged air-conditioner series, set the indoor unit address with SW2 on the indoor unit PCB from [0] to [F] so as not to duplicate.

Restrictions on the thickness and length of wire (Maximum length is 600m.)

Standard	Within	0.3 mm ² × 100m
	Within	0.5 mm ² × 200m
	Within	0.75mm ² × 300m
	Within	1.25mm ² × 400m
	Within	2.0 mm ² × 600m

For the shop series

For VRF series, set the indoor unit address with SW1, SW2 and SW5-2 on the indoor unit PCB from [000] to [127] so as not to duplicate.

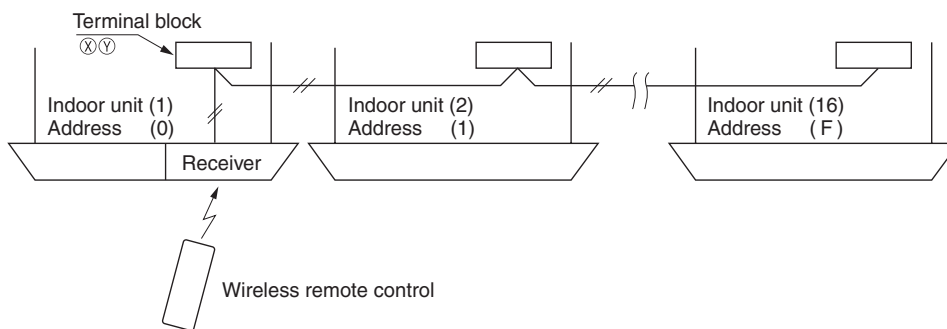

For the building air-conditioning and gas heat pump series

Set the indoor unit and outdoor unit numbers by manually specifying the addresses.

Use the rotary switches SW1 and SW2 provided on the indoor unit PCB (printed circuit board) to set the indoor unit numbers so that they are not duplicated.

Master/Slave setting when using multiple remote control

Up to two receivers can be installed in one indoor unit group.

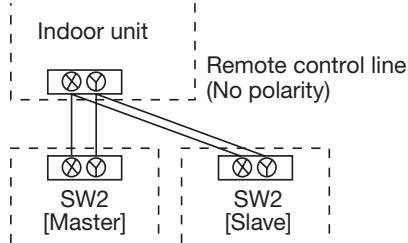

Switch	Setting	Function
SW2	ON	Master
	OFF	Slave

Wireless remote control's operable area

1. Standard reachable area of the signal

[Condition] Illuminance at the receiver: 300lux

(When no lighting is installed within 1m of the receiver in an ordinary office)

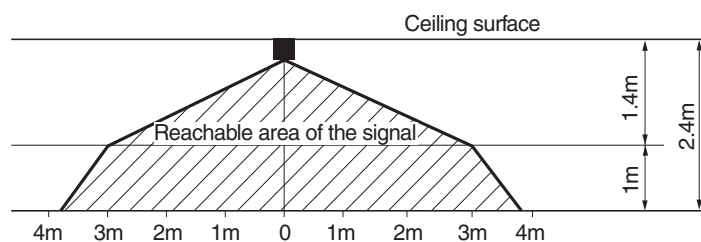

⑤ Receiver (continued)

2. Correlation between illuminance at the receiver and reachable area of the signal in a plain view.

The drawing in the right shows the correlation between the reachable area of the signal and illuminance at the receiver when the remote control is operated at 1m high under the condition of ceiling height of 2.4m. When the illuminance becomes double, the area is narrowed down to two thirds.

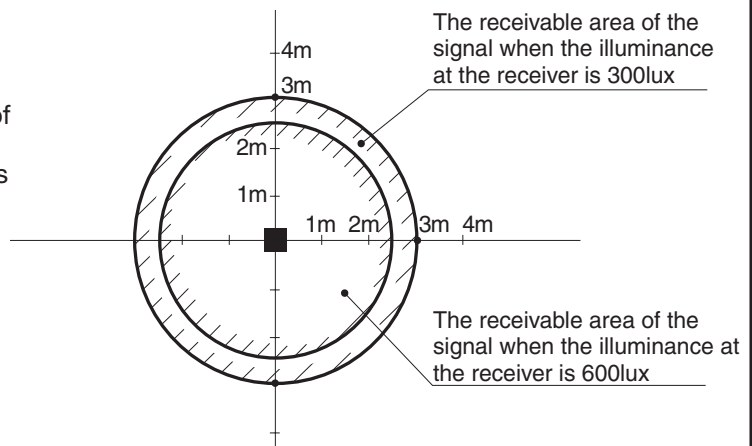

3. Installation tips when several receivers are installed close to one another.

Minimum distance between the indoor units which can avoid cross communication is 5m under the condition of 300lux of illuminance at the receiver.

(When no lighting is installed within 1m of the receiver in an ordinary office)

Backup switch

A backup switch is provided on the receiver section of the panel surface.

When operation from the wireless remote control unit is not possible (due to flat batteries, a mislaid unit, a unit failure), you can use it as an emergency means. You should operate this switch manually.

1. If pressed while the air-conditioner is in a halt, it will cause the air-conditioner to start operation in the automatic mode (In case of cooling only, it is in the cooling mode).
Wind speed: Hi fan, Temperature setting: 23°C, Louver: horizontal
2. If pressed while the air-conditioner is in operation, it will stop the air-conditioner.

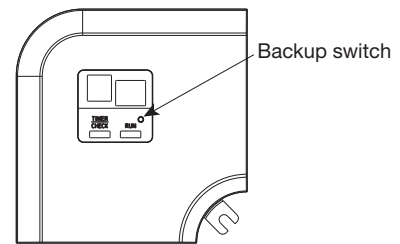

Cooling test run operation

- After safety confirmation, turn on the power.
- Transmit a cooling operation command with the wireless remote control unit, while the backup switch on the receiver is pressed.
- If the backup switch on the receiver is pressed during a test run, it will end the test run.
- If you cannot operate the unit properly during a test run, please check wiring by consulting with inspection guides.

How to read the two-digit display

On the receiver of a wireless kit, a two-digit (7-segment) display is provided.

1. An indication will be displayed for one hour after power on.
2. An indication will be displayed for 3.5 seconds after transmitting a "STOP" command from the wireless remote control or the operation of the backup switch to stop the unit.
3. An indication appearing in (1) or (2) above will go off as soon as the unit starts operation.
4. When there are no error records to indicate, addresses of all the connected units are displayed.
5. When there are some error records remaining, the error records are displayed.
6. Error records can be cleared by transmitting a "STOP" command from the wireless remote control, while the backup button is pressed.

(2) FDUM series (RCN-KIT4-E2)

(a) Specification

PJZ000Z323

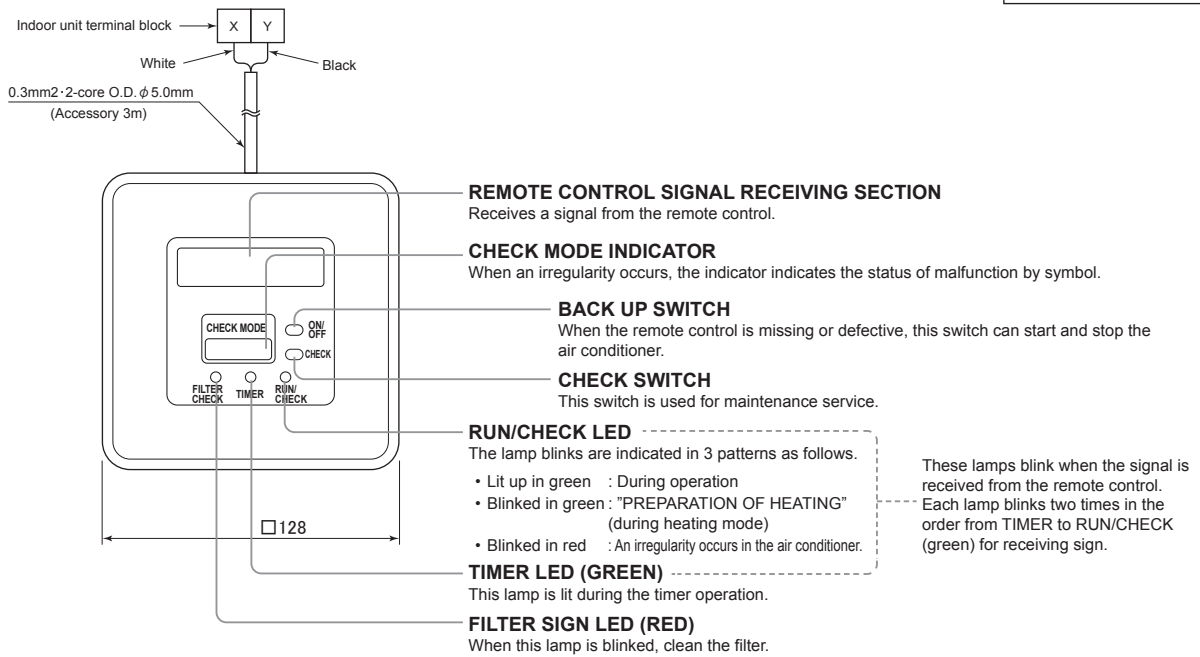

Dimensions of ceiling or wall opening

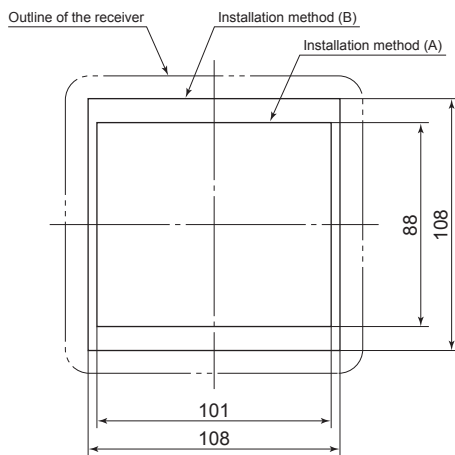

Dimensions of the receiver installation

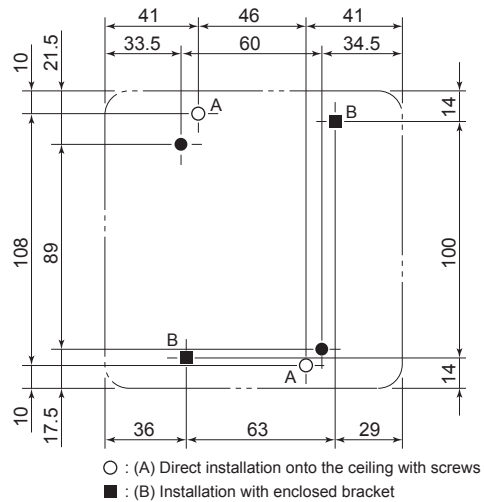

Installation of the receiver

(The following two methods can be used to install the receiver onto a ceiling or a wall.)
(Select a method according to the installation position.)

(A) Direct installation onto the ceiling with screws

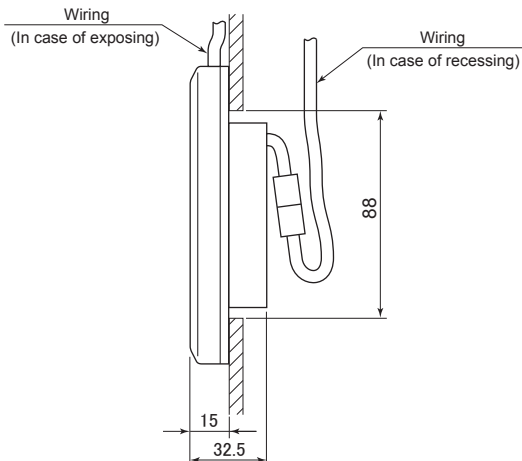

(B) Installation with enclosed bracket

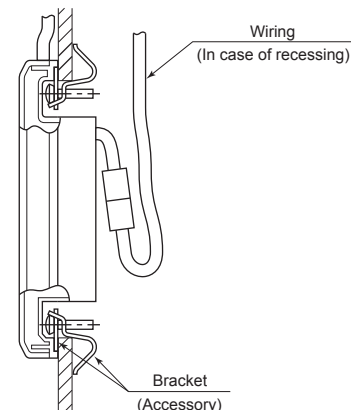

Installation precautions

Do not install it on the following places in order to avoid malfunction.

- (1) Places exposed to direct sunlight
- (2) Places near heat devices
- (3) High humidity places
- (4) Hot surface or cold surface enough to generate condensation
- (5) Places exposed to oil mist or steam directly
- (6) Uneven surface
- (7) Places affected by the direct airflow of the AC unit
- (8) Places where the receiver is influenced by the fluorescent lamp (especially inverter type) or sunlight
- (9) Places where the receiver is affected by infrared rays of any other communication devices
- (10) Places where some object may obstruct the communication with the remote control

Adapted to **RoHS** directive

Wireless remote control operable area

When installed on ceiling

1. Standard reachable area of the signal

[Condition] Illuminance at the receiver : **300lux** (when no lighting is installed within 1m of the receiver in an ordinary office.)

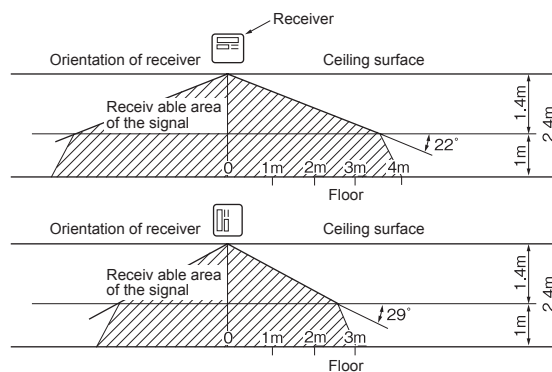

2. Correlation between illuminance at the receiver and reachable area of the signal in a plain view.

[Condition] Correlation between the reachable area of the signal and illuminance at the receiver when the wireless remote control is operated at 1m high under the condition of ceiling height of 2.4m.

When the illuminance becomes double, the area is narrowed down to two third.

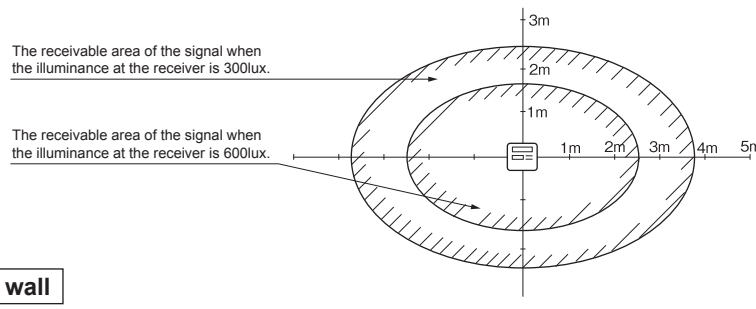

When installed on wall

[Condition] Illuminance at the receiver : **800lux**

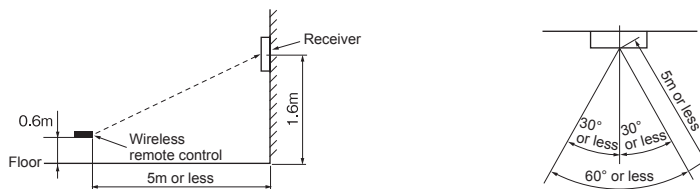

Remote control

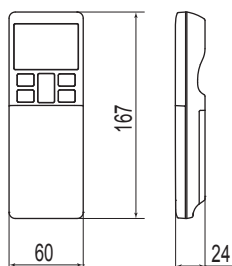

Remote control holder

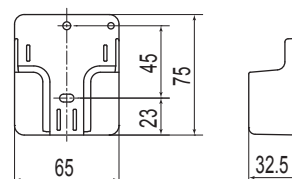

Note
(1) Two LR03 AAA dry cell batteries for remote control are enclosed.













Safety precautions

- Please read this manual carefully before starting installation work to install the unit properly. Every one of the followings is important information to be observed strictly.
 - ⚠ **WARNING** Failure to follow these instructions properly may result in serious consequences such as death, severe injury, etc.
 - ⚠ **CAUTION** Failure to follow these instructions properly may cause injury or property damage. It could have serious consequences depending on the circumstances.
- The following pictograms are used in the text.

	Never do.		Always follow the instructions given.
---	-----------	---	---------------------------------------

- Keep this manual at a safe place where you can consult with whenever necessary. Show this manual to installers when moving or repairing the unit. When the ownership of the unit is transferred, this manual should be given to a new owner.

WARNING

-  • **Consult your dealer or a professional contractor to install the unit.**
Improper installation made on your own may cause electric shocks, fire or dropping of the unit.
-  • **Installation work should be performed properly according to this installation manual.**
Improper installation work may result in electric shocks, fire or break-down.
-  • **Be sure to use accessories and specified parts for installation work.**
Use of unspecified parts may result in drop, fire or electric shocks.
-  • **Install the unit properly to a place with sufficient strength to hold the weight.**
If the place is not strong enough, the unit may drop and cause injury.
-  • **Be sure to have the electrical wiring work done by qualified electrical installer, and use exclusive circuit.**
Power source with insufficient and improper work can cause electric shock and fire.
-  • **Shut OFF the main power source before starting electrical work.**
Otherwise, it could result in electric shocks, break-down or malfunction.
-  • **Do not modify the unit.**
It could cause electric shocks, fire, or break-down.
-  • **Be sure to turn OFF the power circuit breaker before repairing/inspecting the unit.**
Repairing/inspecting the unit with the power circuit breaker turned ON could cause electric shocks or injury.
-  • **Do not install the unit in appropriate environment or where inflammable gas could generate, flow in, accumulate or leak.**
If the unit is used at places where air contains dense oil mist, steam, organic solvent vapor, corrosive gas (ammonium, sulfuric compound, acid, etc) or where acidic or alkaline solution, special spray, etc. are used, it could cause electric shocks, break-down, smoke or fire as a result of significant deterioration of its performance or corrosion.
-  • **Do not install the unit where water vapor is generated excessively or condensation occurs.**
It could cause electric shocks, fire, or break-down.
-  • **Do not use the unit in a place where it gets wet, such as laundry room.**
It could cause electric shocks, fire, or break-down.
-  • **Do not operate the unit with wet hands.**
It could cause electric shocks.

⚠ WARNING



• **Do not wash the unit with water.**
It could cause electric shocks, fire, or break-down.



• **Use the specified cables for wiring, and connect them securely with care to protect electronic parts from external forces.**
Improper connections or fixing could cause heat generation, fire, etc.



• **When installing the unit at a hospital, telecommunication facility, etc., take measures to suppress electric noises.**
It could cause malfunction or break-down due to hazardous effects on the inverter, private power generator, high frequency medical equipment, radio communication equipment, etc.
The influences transmitted from the remote control to medical or communication equipment could disrupt medical activities, video broadcasting or cause noise interference.



• **Do not leave the remote control with its PCB case removed.**
If dew, water, insect, etc. enters through the hole, it could cause electric shocks, fire or break-down.

⚠ CAUTION



- Do not install the wireless kit at the following places in order to avoid malfunction. It could cause break-down or deformation of remote control.
- | | |
|---|--|
| (1) Places exposed to direct sunlight | (8) Places where the receiver is influenced by the fluorescent lamp (especially inverter type) or sunlight |
| (2) Places near heat devices | (9) Places where the receiver is affected by infrared rays of any other communication devices |
| (3) High humidity places | (10) Places where some object may obstruct the communication with the remote control |
| (4) Hot surface or cold surface enough to generate condensation | |
| (5) Places exposed to oil mist or steam directly | |
| (6) Uneven surface | |
| (7) Places affected by the direct air flow of the AC unit | |

① Accessories

Please make sure that you have all of the following accessories.

① Receiver		1		① Wireless remote control (RCN-E2)		1
② Wiring (3m)		1		② Remote control holder		1
③ Parts set (A)		1		③ Screw for holder		2
④ Parts set (B)		1		④ AAA dry cell battery (LR03)		2
⑤ Parts set (C)		1		⑤ User's manual		1
⑥ Installation manual		1		① Screw for receiver		2
				② Fixing band		1
				③ Clamp		5
				④ Screw for clamp		5
				① Receiver installation bracket		1
				② Screw for the bracket		2
				③ Installation fitting		2

② Preparation before installation

Setting on site

PCB on the receiver has the following switches to set the function. Default setting is shown with mark.

SW1	Prevents interference during plural setting	ON : Normal	OFF : Customized
SW2	Receiver master/slave setting	ON : Master	OFF : Slave
SW3			
SW4	Auto restart	ON : Valid	OFF : Invalid

② Preparation before installation (continued)

To change setting

1. Remove one screws located on the under of the receiver and detach the board.
2. Change the setting by the switch on PCB.

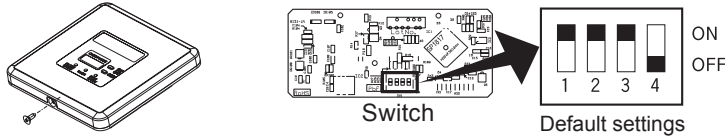

3. When SW1 is turned to OFF position, change the wireless remote control setting. For the method of changing the setting, refer to **Setting to avoid mixed communication** of ④ **Wireless remote control**.

*The receivable area of the signal refer to ⑤ **Receiver**.

Master/Slave setting when using plural remote controls

Up to two receiver or wired remote control can be installed in one indoor unit group. When two receiver or wired remote control are used, it is necessary to change switch on the PCB to set it as slave.

③ How to install the receiver

The following two methods can be used to install the receiver onto a ceiling or a wall. Select a method according to the installation position.

- <Installation position>** (A) Direct installation onto the ceiling with wood screws.
(B) Installation with accessory's bracket

(1) Drilling of the ceiling (ceiling opening)

Drill the receiver installation holes with the dimensions shown right at the ceiling position where wires can be connected.

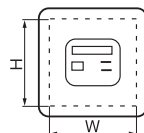

(A) Direct installation onto the ceiling with wood screws.	88mm(H)×101mm(W)
(B) Installation with enclosed bracket	108mm(H)×108mm(W)

(2) Wiring connection of receiver

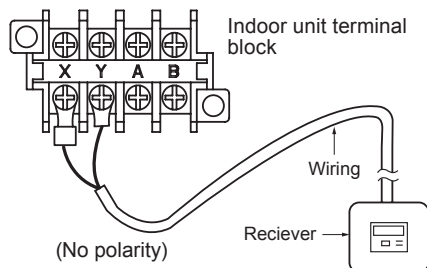

⚠ Caution

Do not connect the wiring to the power source of the terminal block. If it is connected, printed board will be damaged.

(3) Installation of the receiver

Remove the screw on the side of the receiver and split it into the upper case and lower case. Install the receiver with one of the two installation methods (A) to (C) shown below.

(A) Direct installation onto the ceiling with screws

- ▷ Use this installation method when the ceiling is wooden, and there is no problem for strength in installing directly with wood screws.
- ① Put through the wiring from the back side to the hole of the lower case.
 - ② Fit the lower case into the ceiling opening. Make sure that the clearance between the convex part of the back of the lower case and the ceiling opening must be as equal as possible on both sides.
 - ③ Using the two installation holes shown right, fix the lower case onto the ceiling with the enclosed wood screws. (The other four holes are not used.)
 - ④ Connect the wiring with the wiring from the upper case by the connector.

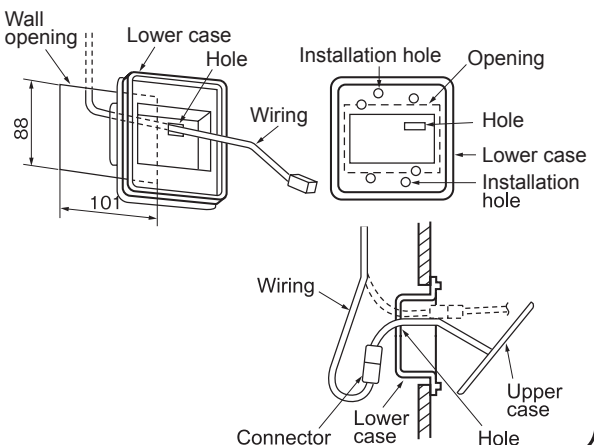

③ How to install the receiver(continued)

- ⑤ Take out the connector to the backside from the hole of the lower case putting through the wiring at ①.
- ⑥ Fit the upper case and the lower case, and tighten the screws.

(B) Installation with enclosed bracket

Use this method when installainga onto a gypsum board (7 to 18mm), etc.

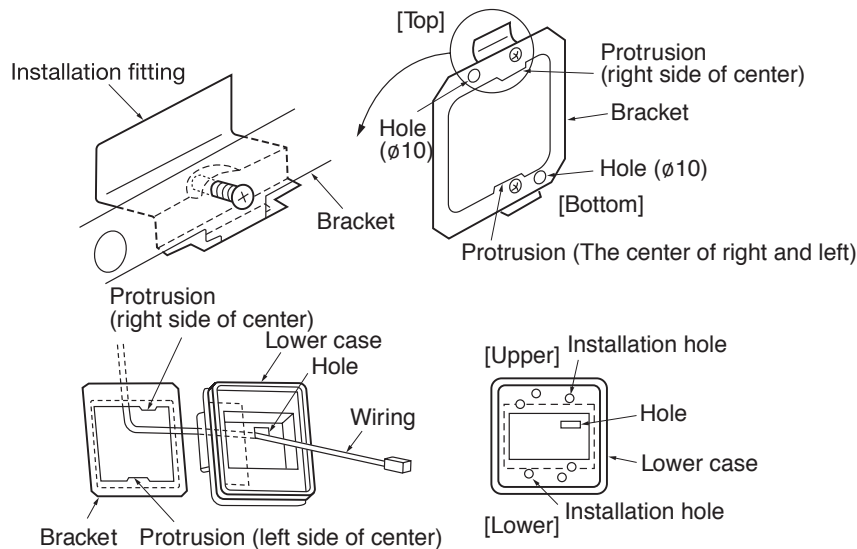

- ① Catch the two protrusion of the enclosed bracket onto the fitting as shown above, and temporarily fix with the screws. (The bracket has an Upper/Lower and front/back orientation. Confirm the Upper/Lower protrusion positions and the positional relation of the $\phi 10$ holes on the bracket and the installation hole on the lower case with the above drawing.)
- ② Insert the end of the installation fitting into the back of the ceiling from the opening, and tighten the screws to fix the bracket onto the ceiling.
- ③ Pass the wiring from the rear side through the hole on the lower case.
- ④ Fit the lower case onto the bracket, and fix the lower case to the bracket using the two installation holes shown above. (The other four holes are not used.)
- ⑤ Follow step ① to ⑥ for (A) to complete the installation.

③ How to install the receiver (continued)

(C) Exposed installation

Use the following procedure when installing the case with the wiring exposed.

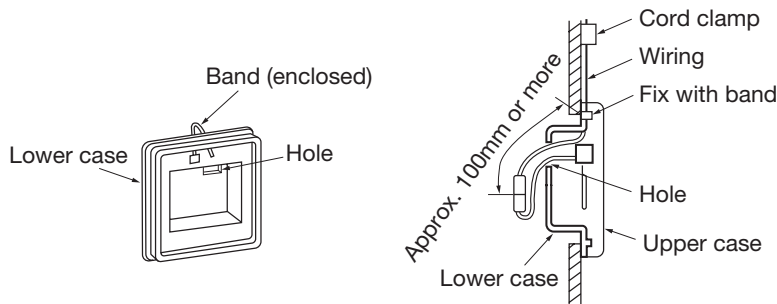

- ① Cut off the thin section on the side of the upper case with a pair of nippers or a knife, and remove the burrs with a file, etc. (The wiring is passed through this section.)
- ② Pass the enclosed band through the wiring outlet hole on the lower case.
- ③ Use one of the light detection adaptor installation methods (A) or (B) explained in section 3, and fix the lower case onto the wall. Do not pass the wiring through the hole on the lower case.
- ④ Fix the wiring using the band while leaving the wiring length from the band fixing section to the end of the wiring connector at 100mm or more.
- ⑤ Connect the wiring with the wiring protruding from the upper case using a connector.
- ⑥ Pass the connected connector and the excess wiring through the hole on the lower case.
- ⑦ Fit the upper case onto the lower case, and tighten the screws.
- ⑧ Adequately fix the wiring with the enclosed cord clamp.

④ Wireless remote control

Installation tips for the remote control holder

Fix the remote control holder using the screws supplied with this product.

* Precautions for installing the holder

- Adjust the position so that it is upright.
- Ensure that the screw heads are not protruding.
- Do not attach the holder on plaster wall.

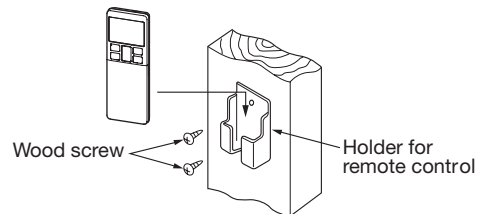

How to insert batteries

1. Detach the back lid.
2. Insert the batteries. (two AAA batteries)
3. Reattach the back lid.

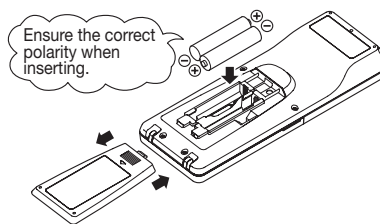

Setting to avoid mixed communication

1. Detach the back lid, and remove the batteries.
2. Cut off the switching wire in the battery compartment using nippers.
3. Insert the batteries, and attach the back lid.

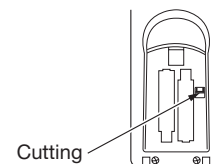

④ Wireless remote control (continued)

Changing the wireless remote control setting

How to change the Auto Run setting

The Auto Run mode is not available on the building air-conditioner and gas heat pump series (excluding the cooling/heating free multi system).

When using the wireless remote control to operate those models, set the wireless remote control to disable the Auto Run mode.

To disable the Auto Run mode, press the **ACL** switch while holding down the **MODE** button, or insert batteries while holding down the **MODE** button.

* Note: Once the batteries are removed, the setting is reset to the factory default. When the batteries are removed, repeat the steps described above.

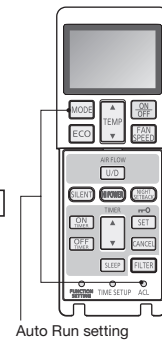

Auto Run setting

Indoor function settings

1. How to set indoor functions

- ① Press the ON/OFF button to stop the unit.
 - ② Press the desired one of the buttons shown below while holding down the FUNCTION SETTING switch.
 - ③ Use the selection buttons, ▲ and ▼, to change the setting.
 - ④ Press the SET button.
- The buzzer on the wireless remote control signal receiver beeps twice, and the LED lamp flashes four times at two-second intervals.

2. Setting details

The following functions can be set.

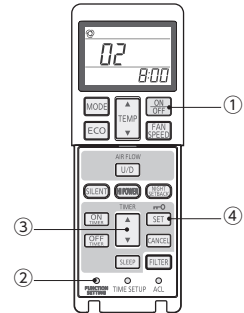

Button	Number indicator	Function setting	Button	Number indicator	Function setting
FAN SPEED	00	Fun speed setting : Standard	ON TIMER	00	Cooling fan residual-period running : Disable
	01	Fun speed setting : Setting 1 *		01	Cooling fan residual-period running : 0.5 hours
	02	Fun speed setting : Setting 2 *		02	Cooling fan residual-period running : 2 hours
MODE	00	Room heating temperature adjustment : Disable	OFF TIMER	03	Cooling fan residual-period running : 6 hours
	01	Room heating temperature adjustment : +1°C		00	Heating fan residual-period running : Disable
	02	Room heating temperature adjustment : +2°C		01	Heating fan residual-period running : 0.5 hours
	03	Room heating temperature adjustment : +3°C		02	Heating fan residual-period running : 2 hours
FILTER	00	Filter sign display : OFF	NIGHT SETBACK	03	Heating fan residual-period running : 6 hours
	01	Filter sign display : 180 hours		00	Remote control signal receiver LED : Brightness High
	02	Filter sign display : 600 hours		01	Remote control signal receiver LED : Brightness Low
	03	Filter sign display : 1000 hours		02	Remote control signal receiver LED : OFF
U/D	04	Filter sign display : Operation stop after 1000 hours have elapsed	* Refer to service manual.		
	00	Anti draft setting : Disable			
SILENT	01	Anti draft setting : Enable			
	00	Infrared sensor setting (Motion sensor setting) : Disable			
HI POWER	01	Infrared sensor setting (Motion sensor setting) : Enable			
	00	Infrared sensor control (Motion sensor control) : Disable			
	01	Infrared sensor control (Motion sensor control) : Power control only			
	02	Infrared sensor control (Motion sensor control) : Auto OFF only			
	03	Infrared sensor control (Motion sensor control) : Power control and Auto OFF			

⑤ Receiver

1 Control plural indoor units with one remote control

Up to 16 indoor units can be connected.

1. Connect the XY terminal with 2 cores wire. As for the size, refer to the following note.
2. For Packaged air-conditioner series, set the indoor unit address with SW2 on the indoor unit PCB from [0] to [F] so as not to duplicate.

Restrictions on the thickness and length of wire (Maximun total extension 600m.)

Standard	Within	Thickness	Length
	0.3 mm ²	× 100m	
	0.5 mm ²	× 200m	
	0.75mm ²	× 300m	
	1.25mm ²	× 400m	
	2.0 mm ²	× 600m	

⑤ Receiver (continued)

For the shop series

For VRF series, set the indoor unit address with SW1, SW2 and SW5-2 on the indoor unit PCB from [000] to [127] so as not to duplicate.

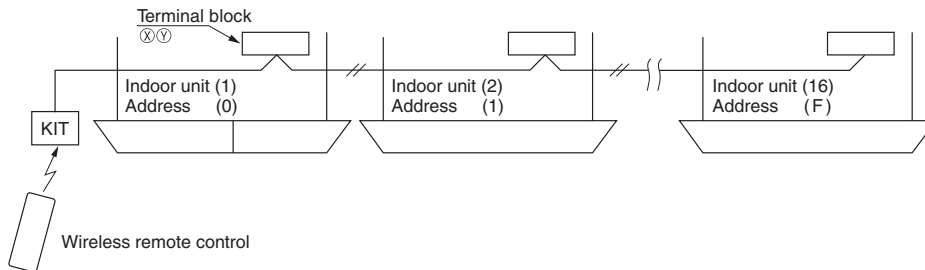

For the building air-conditioner and gas heat pump series

Set the indoor unit and outdoor unit numbers by manually specifying the addresses. Use the rotary switches SW1 and SW2 provided on the indoor unit PCB (printed circuit board) to set the indoor unit numbers so that they are not duplicated.

Master/Slave setting when using plural remote control

Up to two receivers can be installed in one indoor unit group.

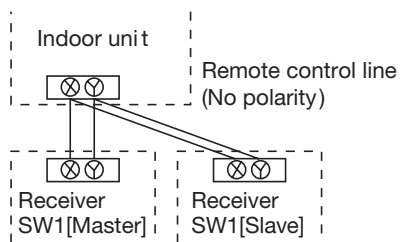

Switch	Setting	Function
SW2	ON	Master
	OFF	Slave

When installed on ceiling

1. Standard reachable area of the signal

[Condition] Illuminance at the receiver : **300lux** (when no lighting is installed within 1m of the receiver in an ordinary office.)

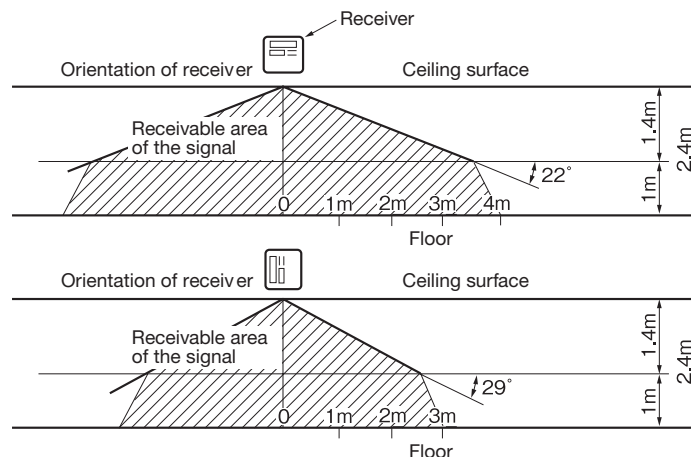

2. Correlation between illuminance at the receiver and reachable area of the signal in a plain view.

[Condition] Correlation between the reachable area of the signal and illuminance at the receiver when the wireless remote control is operated at 1m high under the condition of ceiling height of 2.4m. When the illuminance becomes double, the area is narrowed down to two third.

⑤ Receiver (continued)

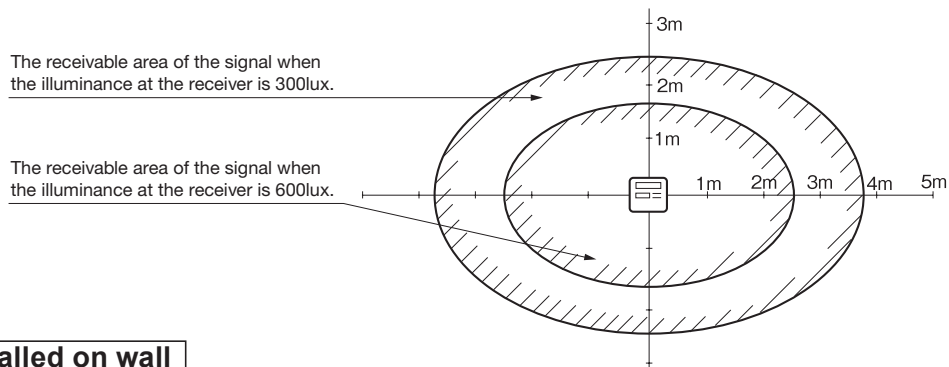

When installed on wall

[Condition] Illuminance at the receiver : 800lux.

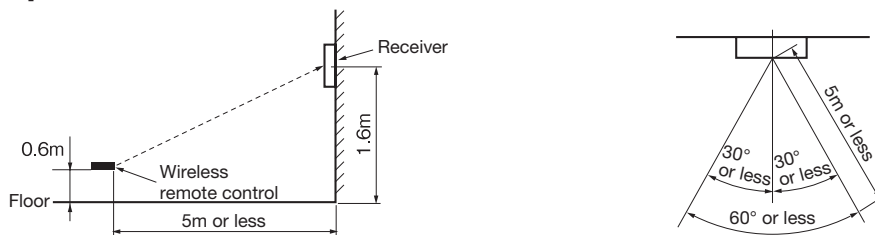

Backup switch

A backup switch is provided on the receiver section of the panel surface. When operation from the wireless remote control is not possible (due to flat batteries, a mislaid unit, a unit failure), you can use it as an emergency means. You should operate this switch manually.

1. If pressed while the air-conditioner is in a halt, it will cause the air-conditioner to start operation in the automatic mode (in the case of cooling only, in the cooling mode). Wind speed: Hi fan, Temperature setting: 23°C, Louver: horizontal
2. If pressed while the air-conditioner is in operation, it will stop the air-conditioner.

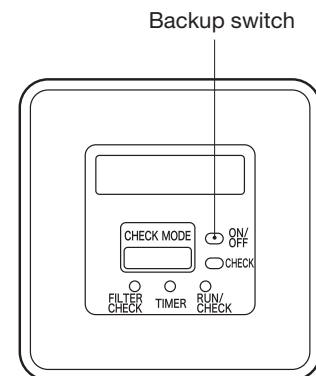

Cooling test run operation

- After safety confirmation, turn on the power.
- Transmit a cooling operation command with the wireless remote control, while the backup switch on the receiver is depressed.
- If the backup switch on the receiver is pressed during a test run, it will end the test run.
- If you cannot operate the unit properly during a test run, please check wiring by consulting with inspection guides.

How to read the 6-digit display

A 6-digit indicator (7-segment indicator) is provided on the receiver section.

1. An indication will be displayed for one hour after power on.
2. An indication appears for 3.5 seconds when a "Stop" command is sent from the wireless remote control unit while the air-conditioner is not running.
3. An indication appearing in (1) or (2) above will go off as soon as the unit starts operation.
4. When there are no error records to indicate, addresses are displayed for all of the connected units.
5. When there are some error records remaining, the error records are displayed.
6. Error records can be cleared by transmitting a "Stop" command from the wireless remote control unit, while the backup switch is depressed.

(3) FDE series (RCN-E-E3)

(a) Specification

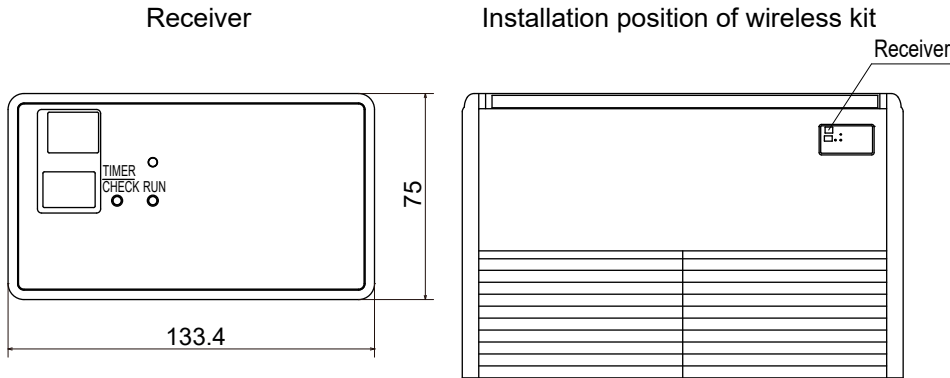

- Notes
- (1) Two LR03 AAA dry cell batteries for remote control are enclosed.
 - (2) See spec sheet of "Wireless remote control" about remote control.

Setting switch on PCB of receiver

SW1	Prevent interference during plural setting	ON : Normal OFF : Remote
SW2	Receiver master/slave setting	ON : Master OFF : Slave
SW3	Buzzer	ON : Valid OFF : Invalid
SW4	Auto restart	ON : Valid OFF : Invalid

Default setting: mark

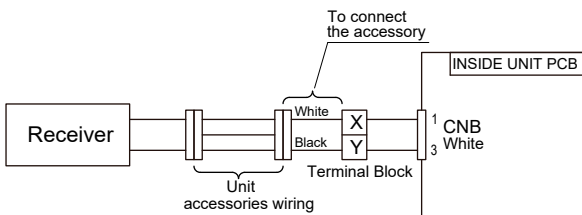

Installation of wireless kit

Do not install the wireless kit at the following places in order to avoid malfunction.

- (1) Places exposed to direct sunlight
- (2) Places near heat devices
- (3) High humidity places
- (4) Hot surface or cold surface enough to generate condensation
- (5) Places exposed to oil mist or steam directly
- (6) Uneven surface
- (7) Places affected by the direct airflow of the AC unit
- (8) Places where the receiver is influenced by the fluorescent lamp (especially inverter type) or sunlight
- (9) Places where the receiver is affected by infrared rays of any other communication devices
- (10) Places where some object may obstruct the communication with the remote control

Wireless remote control's operable area

- ① Standard signal receiving range
[condition] Illuminance at the receiver area:360lux.
(When no lighting fixture is located within 1m of indoor unit in an ordinary office)

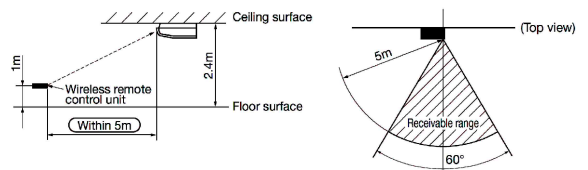

- ② Points for attention in connecting a plural number of indoor units
[condition] Illuminance at the receiver area:360lux.

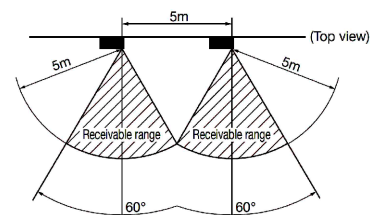

Remote control

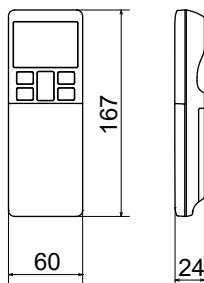

Remote control holder

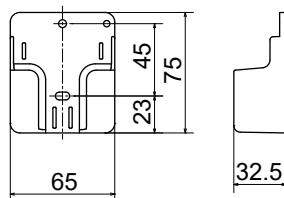

Unit:mm

PFA004Z079

(b) Installation manual

PFA012D635













Safety precautions

- Please read this manual carefully before starting installation work to install the unit properly. Every one of the followings is important information to be observed strictly.
- ⚠ **WARNING** Failure to follow these instructions properly may result in serious consequences such as death, severe injury, etc.
- ⚠ **CAUTION** Failure to follow these instructions properly may cause injury or property damage. It could have serious consequences depending on the circumstances.
- The following pictograms are used in the text.

	Never do.		Always follow the instructions given.
---	-----------	---	---------------------------------------

- Keep this manual at a safe place where you can consult with whenever necessary. Show this manual to installers when moving or repairing the unit. When the ownership of the unit is transferred, this manual should be given to a new owner.

⚠ WARNING

-  • **Consult your dealer or a professional contractor to install the unit.**
Improper installation made on your own may cause electric shocks, fire or dropping of the unit.
-  • **Installation work should be performed properly according to this installation manual.**
Improper installation work may result in electric shocks, fire or break-down.
-  • **Be sure to use accessories and specified parts for installation work.**
Use of unspecified parts may result in drop, fire or electric shocks.
-  • **Install the unit properly to a place with sufficient strength to hold the weight.**
If the place is not strong enough, the unit may drop and cause injury.
-  • **Be sure to have the electrical wiring work done by qualified electrical installer, and use exclusive circuit.**
Power source with insufficient and improper work can cause electric shock and fire.
-  • **Shut OFF the main power source before starting electrical work.**
Otherwise, it could result in electric shocks, break-down or malfunction.
-  • **Do not modify the unit.**
It could cause electric shocks, fire, or break-down.
-  • **Be sure to turn OFF the power circuit breaker before repairing/inspecting the unit.**
Repairing/inspecting the unit with the power circuit breaker turned ON could cause electric shocks or injury.
-  • **Do not install the unit in appropriate environment or where inflammable gas could generate, flow in, accumulate or leak.**
If the unit is used at places where air contains dense oil mist, steam, organic solvent vapor, corrosive gas (ammonium, sulfuric compound, acid, etc) or where acidic or alkaline solution, special spray, etc. are used, it could cause electric shocks, break-down, smoke or fire as a result of significant deterioration of its performance or corrosion.
-  • **Do not install the unit where water vapor is generated excessively or condensation occurs.**
It could cause electric shocks, fire, or break-down.
-  • **Do not use the unit in a place where it gets wet, such as laundry room.**
It could cause electric shocks, fire, or break-down.
-  • **Do not operate the unit with wet hands.**
It could cause electric shocks.

⚠ WARNING



• **Do not wash the unit with water.**
It could cause electric shocks, fire, or break-down.



• **Use the specified cables for wiring, and connect them securely with care to protect electronic parts from external forces.**
Improper connections or fixing could cause heat generation, fire, etc.



• **When installing the unit at a hospital, telecommunication facility, etc., take measures to suppress electric noises.**
It could cause malfunction or break-down due to hazardous effects on the inverter, private power generator, high frequency medical equipment, radio communication equipment, etc. The influences transmitted from the remote control to medical or communication equipment could disrupt medical activities, video broadcasting or cause noise interference.



• **Do not leave the remote control with its PCB case removed.**
If dew, water, insect, etc. enters through the hole, it could cause electric shocks, fire or break-down.

⚠ CAUTION



• Do not install the wireless kit at the following places in order to avoid malfunction. It could cause break-down or deformation of remote control.

(1) Places exposed to direct sunlight	(8) Places where the receiver is influenced by the fluorescent lamp (especially inverter type) or sunlight.
(2) Places near heat devices	(9) Places where the receiver is affected by infrared rays of any other communication devices.
(3) High humidity places	(10) Places where some object may obstruct the communication with the remote control
(4) Hot surface or cold surface enough to generate condensation	
(5) Places exposed to oil mist or steam directly	
(6) Uneven surface	
(7) Places affected by the direct air flow of the AC unit.	

① Accessories

Please make sure that you have all of the following accessories.

① Receiver		1	① Wireless remote control (RCN-E2)		1
② Parts set		1	② Remote control holder		1
③ Installation manual		1	③ Screw for holder		2
④ Wiring		1	④ AAA dry cell battery (LR03)		2
			⑤ User's manual		1

② Preparation before installation

Setting on site

PCB on the receiver has the following switches to set the function. Default setting is shown with mark.

SW1	Prevents interference during plural setting	ON : <input type="checkbox"/> Normal OFF : <input type="checkbox"/> Customized
SW2	Receiver master/slave setting	ON : <input type="checkbox"/> Master OFF : <input type="checkbox"/> Slave
SW3	Buzzer	ON : <input type="checkbox"/> Valid OFF : <input type="checkbox"/> Invalid
SW4	Auto restart	ON : <input type="checkbox"/> Valid OFF : <input type="checkbox"/> Invalid

② Preparation before installation (continued)

To change setting

1. Remove four screws located on the back of the receiver and detach the board.
2. Change the setting by the switch on PCB.

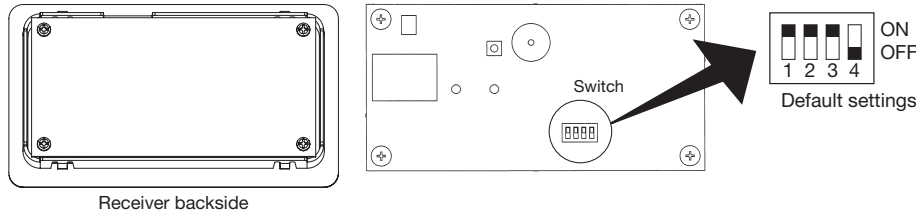

Master/Slave setting when using plural remote controls

Up to two receiver or wired remote control can be installed in one indoor unit group. When two receiver or wired remote control are used, it is necessary to change SW on the PCB to set it as slave.

3. When SW1 is turned to OFF position, change the wireless remote control setting. For the method of changing the setting, refer to **Setting to avoid mixed communication** of

⑤ Wireless remote control

*The receivable area of the signal refer to **⑥ Receiver**.

③ How to install the receiver

The receiver can be installed by replacing with a cover of the panel.

CAUTION: When installing the receiver after unit has been fixed, injury due to falling may result because of working at high place.

- ① **Remove the cover**
Insert a flat-blade screwdriver into the dented part (2 places), and wrench slightly so as not to damage panel surface.
- ② **Connect the wiring**
Connect wiring of the receiver to the wiring in the back.

ATTENTION: Do not remove the clamp fixed the wiring.

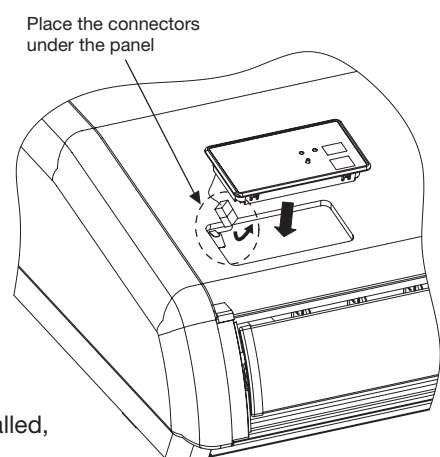
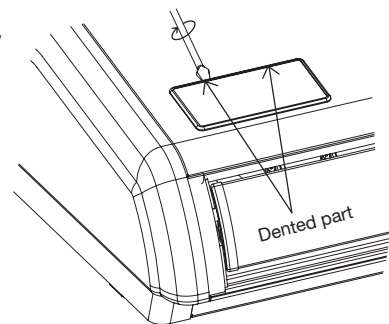
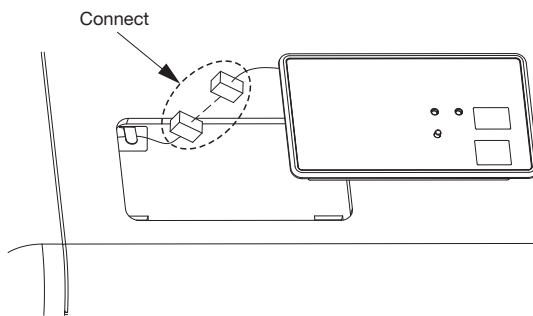

③ Installation of the receiver

Check direction of the receiver, and fix to the panel.

CAUTION: Connect the connectors before installing the receiver. In case of connecting after the receiver had been installed, it will be necessary to remove the panel.

④ How to connect the wiring for control box

Connect the attached wiring to the signal terminal block primary side XY (for grill side) in the control box, and connect to the CNL connector (3P white) from the receiver .

* This installation is unnecessary for indoor unit that have wiring is already connected from the signal terminal block to the receiver.

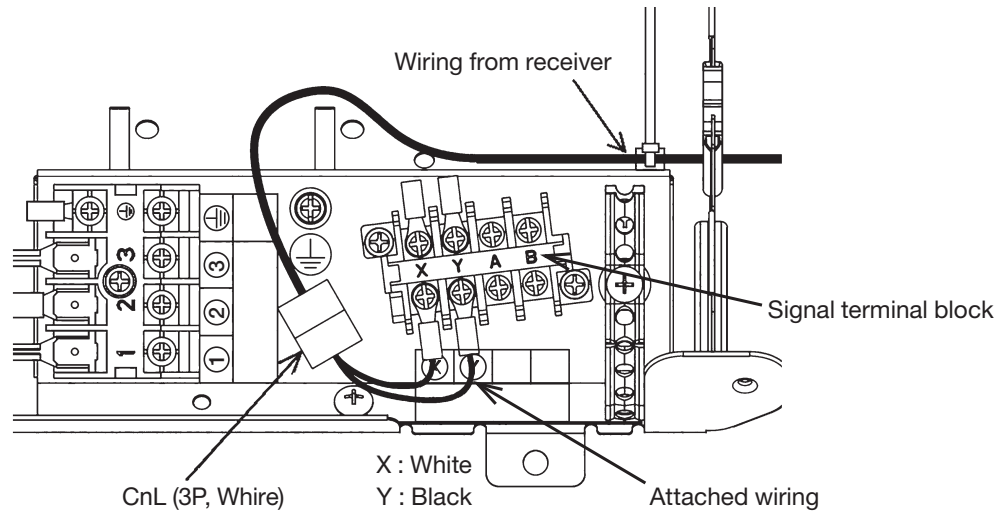

⑤ Wireless remote control

Installation tips for the remote control holder

Fix the remote control holder using the screws supplied with this product.

* Precautions for installing the holder

- Adjust the position so that it is upright.
- Ensure that the screw heads are not protruding.
- Do not attach the holder on plaster wall.

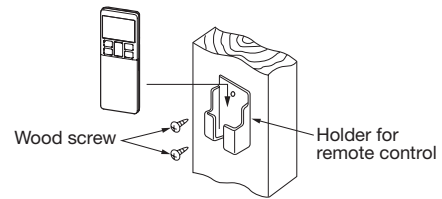

How to insert batteries

1. Detach the back lid.
2. Insert the batteries. (two AAA batteries)
3. Reattach the back lid.

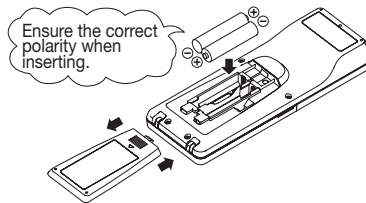

Setting to avoid mixed communication

1. Detach the back lid, and remove the batteries.
2. Cut off the switching wire in the battery compartment using nippers.
3. Insert the batteries, and attach the back lid.

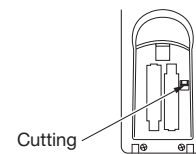

Changing the remote control setting

How to change the Auto Run setting

The Auto Run mode is not available on the building air conditioning and gas heat pump series (excluding the cooling/heating free multi system).

When using the remote control to operate those models, set the remote control to disable the Auto Run mode.

To disable the Auto Run mode, press the [ACL] switch while holding down the [MODE] button, or insert batteries while holding down the [MODE] button.

* Note: Once the batteries are removed, the setting is reset to the factory default. When the batteries are removed, repeat the steps described above.

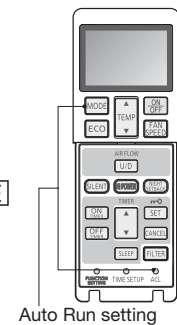

Indoor function settings

1. How to set indoor functions

- ① Press the ON/OFF button to stop the unit.
- ② Press the desired one of the buttons shown item 2. while holding down the FUNCTION SETTING switch.
- ③ Use the selection buttons, ▲ and ▼, to change the setting.
- ④ Press the SET button.

The buzzer on the remote control signal receiver beeps twice, and the LED lamp flashes four times at two-second intervals.

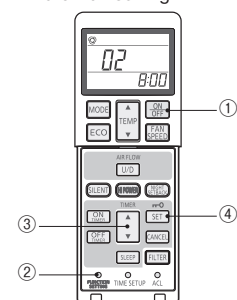

⑤ Wireless remote control (continued)

2. Setting details

The following functions can be set.

Button	Number indicator	Function setting
FAN SPEED	00	Fan speed setting : Standard
	01	Fan speed setting : Setting 1 *
	02	Fan speed setting : Setting 2 *
MODE	00	Room heating temperature adjustment : Disable
	01	Room heating temperature adjustment : +1°C
	02	Room heating temperature adjustment : +2°C
	03	Room heating temperature adjustment : +3°C
FILTER	00	Filter sign display : OFF
	01	Filter sign display : 180 hours
	02	Filter sign display : 600 hours
	03	Filter sign display : 1000 hours
	04	Filter sign display : Operation stop after 1000 hours have elapsed
U/P (Up/Down)	00	Anti draft setting : Disable
	01	Anti draft setting : Enable
SILENT	00	Infrared sensor setting (Motion sensor setting) : Disable
	01	Infrared sensor setting (Motion sensor setting) : Enable
HI POWER	00	Infrared sensor control (Motion sensor control) : Disable
	01	Infrared sensor control (Motion sensor control) : Power control only
	02	Infrared sensor control (Motion sensor control) : Auto OFF only
	03	Infrared sensor control (Motion sensor control) : Power control + Auto OFF
ON TIMER	00	Cooling fan residual-period running : Disable
	01	Cooling fan residual-period running : 0.5 hours
	02	Cooling fan residual-period running : 2 hours
	03	Cooling fan residual-period running : 6 hours
OFF TIMER	00	Heating fan residual-period running : Disable
	01	Heating fan residual-period running : 0.5 hours
	02	Heating fan residual-period running : 2 hours
	03	Heating fan residual-period running : 6 hours
NIGHT SETBACK	00	Remote control signal receiver LED : Brightness High
	01	Remote control signal receiver LED : Brightness Low
	02	Remote control signal receiver LED : OFF

* Refer to service manual.

⑥ Receiver

1 Control plural indoor units with one remote control

Up to 16 indoor units can be connected.

1. Connect the XY terminal with 2 cores wire. As for the size, refer to the following note.
2. For Packaged air conditioner series, set the indoor unit address with SW2 on the indoor unit PCB from [1] to [F] so as not to duplicate.

Restrictions on the thickness and length of wire (Maximun total extension 600m.)

Standard	Within	0.3 mm ² × 100m
	Within	0.5 mm ² × 200m
	Within	0.75mm ² × 300m
	Within	1.25mm ² × 400m
	Within	2.0 mm ² × 600m

For the shop series

For VRF series, set the indoor unit address with SW1, SW2 and SW5-2 on the indoor unit PCB from [000] to [127] so as not to duplicate.

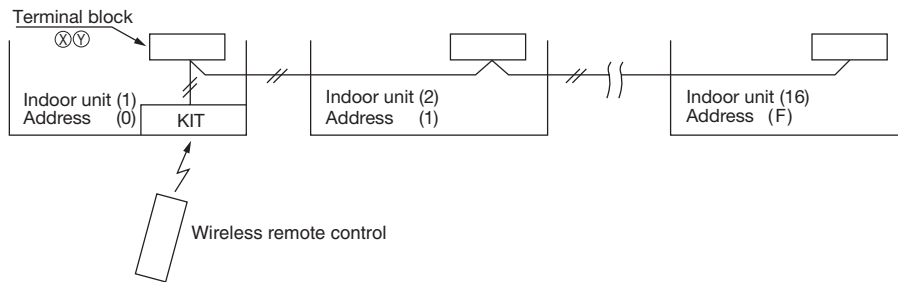

For the building air-conditioning and gas heat pump series

Set the indoor unit and outdoor unit numbers by manually specifying the addresses.

Use the rotary switches SW1 and SW2 provided on the indoor unit PCB (printed circuit board) to set the indoor unit numbers so that they are not duplicated.

Master/Slave setting when using plural remote control

Up to two receivers can be installed in one indoor unit group.

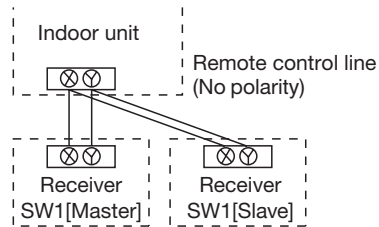

Switch	Setting	Function
SW2	ON	Master
	OFF	Slave

⑥ Receiver (continued)

Wireless remote control's operable area

1. Standard signal receiving range

[Condition]

Illuminance at the receiver area: 300 lux.

(When no lighting fixture is located within 1 m of indoor unit in an ordinary office)

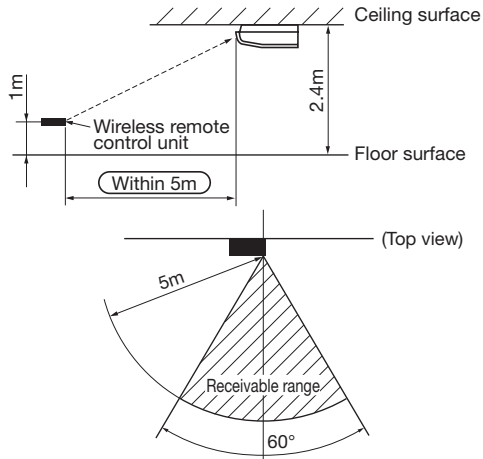

2. Points for attention in connecting a plural number of indoor units

[Condition]

Illuminance at the receiver area: 300 lux.

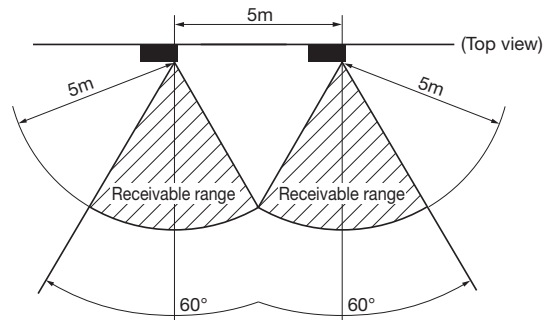

Backup switch

A backup switch is provided on the receiver section of the panel surface.

When operation from the wireless remote control unit is not possible (due to flat batteries, a mislaid unit, a unit failure), you can use it as an emergency means. You should operate this switch manually.

1. If pressed while the air-conditioner is in a halt, it will cause the air-conditioner to start operation in the automatic mode (in the case of cooling only, in the cooling mode).
Wind speed: Hi fan, Temperature setting: 23°C, Louver: horizontal.
2. If pressed while the air-conditioner is in operation, it will stop the air-conditioner.

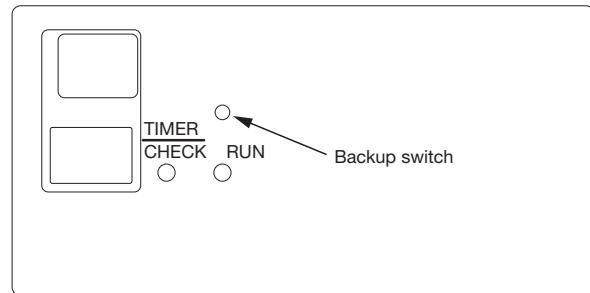

Cooling test run operation

- After safety confirmation, turn on the power.
- Transmit a cooling operation command with the wireless remote control unit, while the backup switch on the receiver is depressed.
- If the backup switch on the receiver is pressed during a test run, it will end the test run.
- If you cannot operate the unit properly during a test run, please check wiring by consulting with inspection guides.

How to read the two-digit display

A two-digit indicator (7-segment indicator) is provided on the receiver section.

1. An indication will be displayed for one hour after power on.
2. An indication appears for 3.5 seconds when a "Stop" command is sent from the wireless remote control unit while the air-conditioner is not running.
3. An indication appearing in (1) or (2) above will go off as soon as the unit starts operation.
4. When there are no error records to indicate, addresses are displayed for all of the connected units.
5. When there are some error records remaining, the error records are displayed.
6. Error records can be cleared by transmitting a "Stop" command from the wireless remote control unit, while the backup switch is depressed.

8.4 Motion sensor kit

(1) FDTC series (LB-TC-5W-E)

(a) Specification

Motion sensor kit

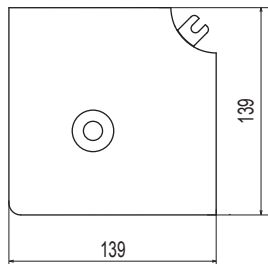

Installation position of motion sensor kit

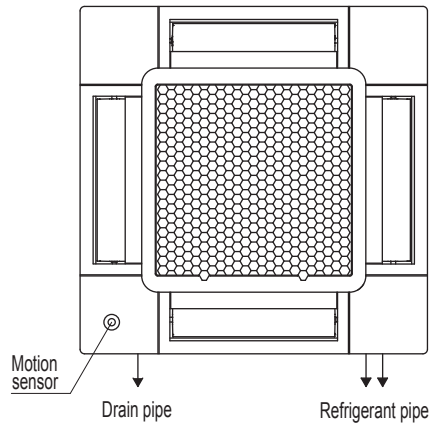

Note

- (1) Motion sensor must be installed to the position as shown.

Installation of motion sensor kit

Do not install the motion sensor kit at the following places in order to avoid malfunction.

- (1) Places exposed to direct sunlight
- (2) Places near heat-generating devices
- (3) High humidity places
- (4) Hot surface or cold surface enough to generate condensation
- (5) Places directly exposed to oil mist or steam
- (6) Places affected by the direct air flow of the indoor unit
- (7) Places where the motion sensor may be influenced by fluorescent lamp or sunlight
- (8) Places where the motion sensor may be affected by infrared rays of any other communication devices
- (9) Places where some object may obstruct the motion sensor
- (10) Places where there may be impact on the motion sensor
- (11) Places with strong radio wave or static electricity
- (12) Dusty place where the motion sensor lens may become tainted or be damaged

The detectable area

Unit:mm

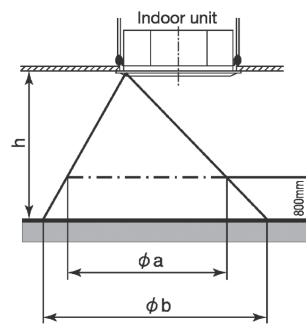



Height of the ceiling		h[m]	2.7	3.5	4.0
Detectable area	ϕa [m]		about 4.5	about 6.4	about 7.6
	ϕb [m]		about 6.4	about 8.3	about 9.5

(b) Installation manual

PJF012D504 

 **WARNING**

- Connect the wiring to the PCB in the control box on the indoor unit and fix the wiring securely so as not to apply unexpected stress on the PCB. Loose connection or fixing will cause abnormal heat generation or fire. 
- Make sure the power source is turned off during electrical wiring work. Otherwise, electric shock, malfunction and abnormal operation may occur. 

 **CAUTION**

- Do not install the motion sensor kit at the following places in order to avoid malfunction.

<ul style="list-style-type: none"> (1) Places exposed to direct sunlight (2) Places near heat-generating devices (3) High humidity places (4) Hot surface or cold surface enough to generate condensation (5) Places directly exposed to oil mist or steam (6) Places affected by the direct air flow of the indoor unit (7) Places where the motion sensor may be influenced by fluorescent lamp or sunlight 	<ul style="list-style-type: none"> (8) Places where the motion sensor may be affected by infrared rays of any other communication devices (9) Places where some object may obstruct the motion sensor (10) Places where there may be impact on the motion sensor (11) Places with strong radio wave or static electricity (12) Dusty place where the motion sensor lens may become tainted or be damaged
--	---
- Do not leave the motion sensor without the cover. In case the cover needs to be detached, protect the motion sensor with a packaging or bag in order to keep it away from water and dust. 

Attention

- Instruct the customer how to operate the motion sensor kit correctly by referring to the instruction manual.
- For the installation method of the air-conditioner itself, refer to the installation manual enclosed in the package.

① Accessories

Please make sure that all components are in the package.

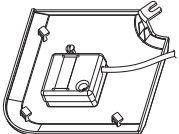
Motion sensor		1
---------------	---	---

② Installing the motion sensor

It is possible to install the motion sensor by replacing the corner lid on the panel.

The detectable area

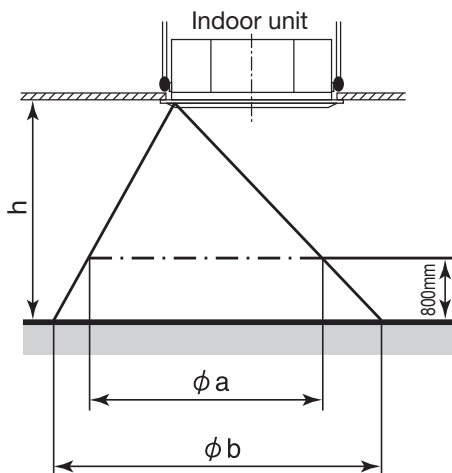

Height of the ceiling	h[m]	2.7	3.5	4.0
Detectable area①	ϕa [m]	about 4.5	about 6.4	about 7.6
Detectable area②	ϕb [m]	about 6.4	about 8.3	about 9.5

Preparation before installation

- ① Remove the inlet grille according to the installation manual of the panel.
- ② Remove the corner lid at the drain pipe side.
- ③ Loosen screws (2 pcs.) on the control box of the unit. (It is not necessary to remove the screws.)
- ④ Slide the control lid in the arrow direction, and remove it.

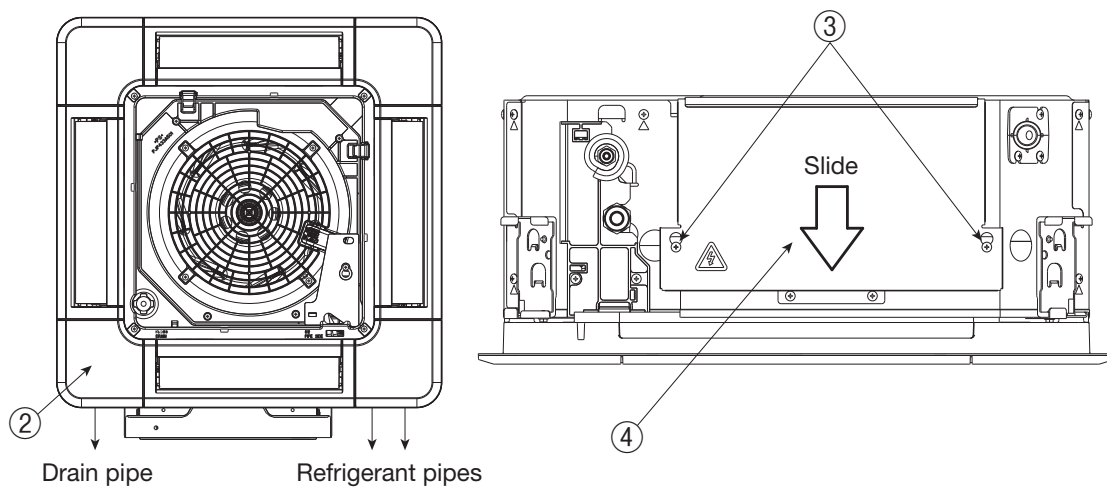

Installation of the motion sensor

- ① Cut the half blanking (4 sections) of the panel as shown in the following figure.
- ② Pass the motion sensor wiring through the opening of the panel.
- ③ Connect the wiring connector to CNL (3P, black) on the PCB in the control box.
- ④ Fix the wiring with a band as shown below.
- ⑤ Install the motion sensor on the panel according to the installation manual of the panel.
- ⑥ Install the control lid with care not to pinch the wiring, and reinstall the control lid with screws (2 pcs.).

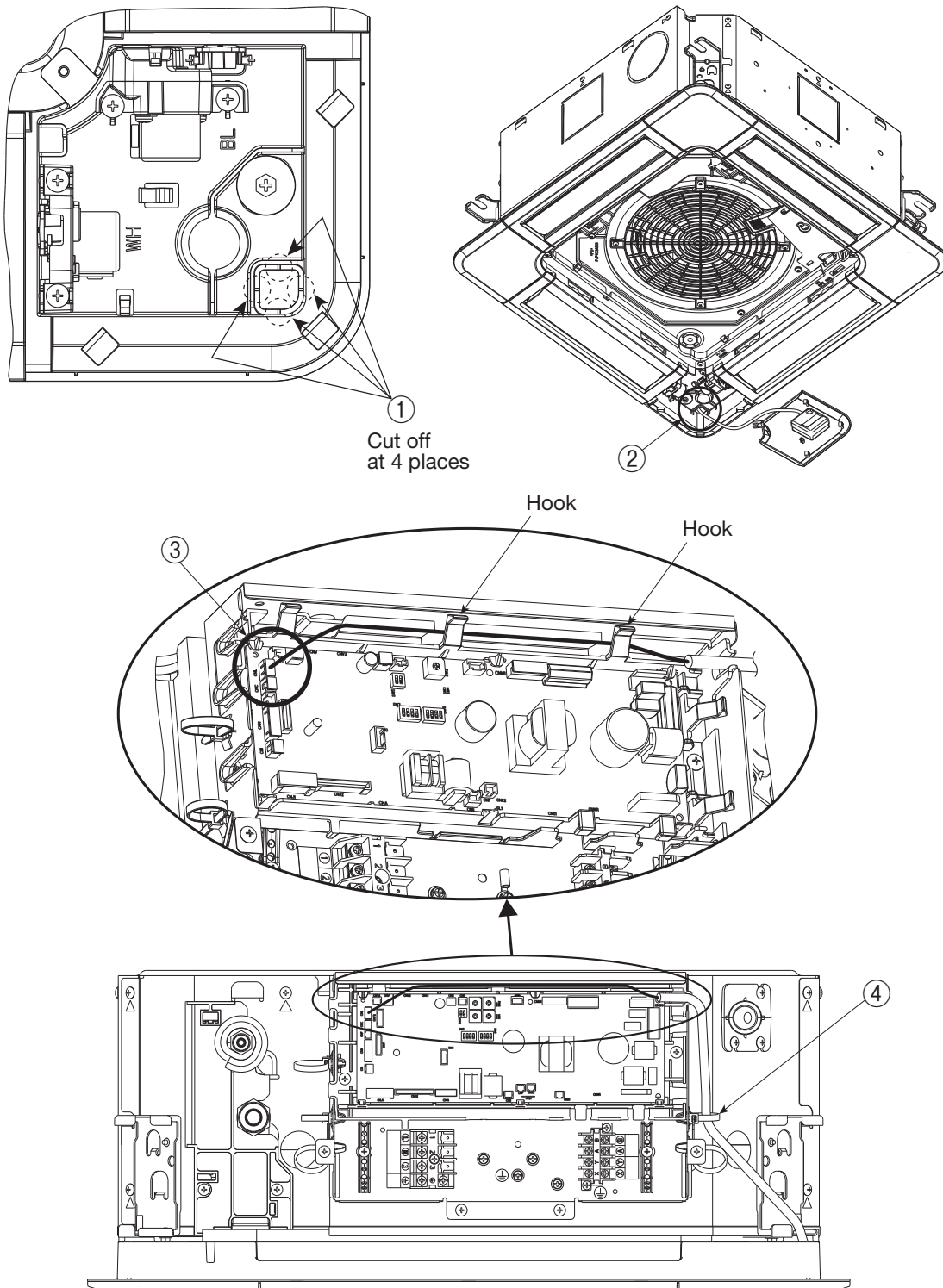

③ Setting the motion sensor

The motion sensor will not function if it is only installed.
Set the function of the motion sensor by the wired or wireless remote control.
Refer to the manual instruction of each remote control for the setting procedure.

Note: It is not possible to set by the following remote control models or older ones.
Wired: RC-EX1A, RC-E5, RCH-E3
Wireless: RCN-E1R

(2) FDUM series (LB-KIT2)

(a) Specification

External dimensions

PJZ000Z341

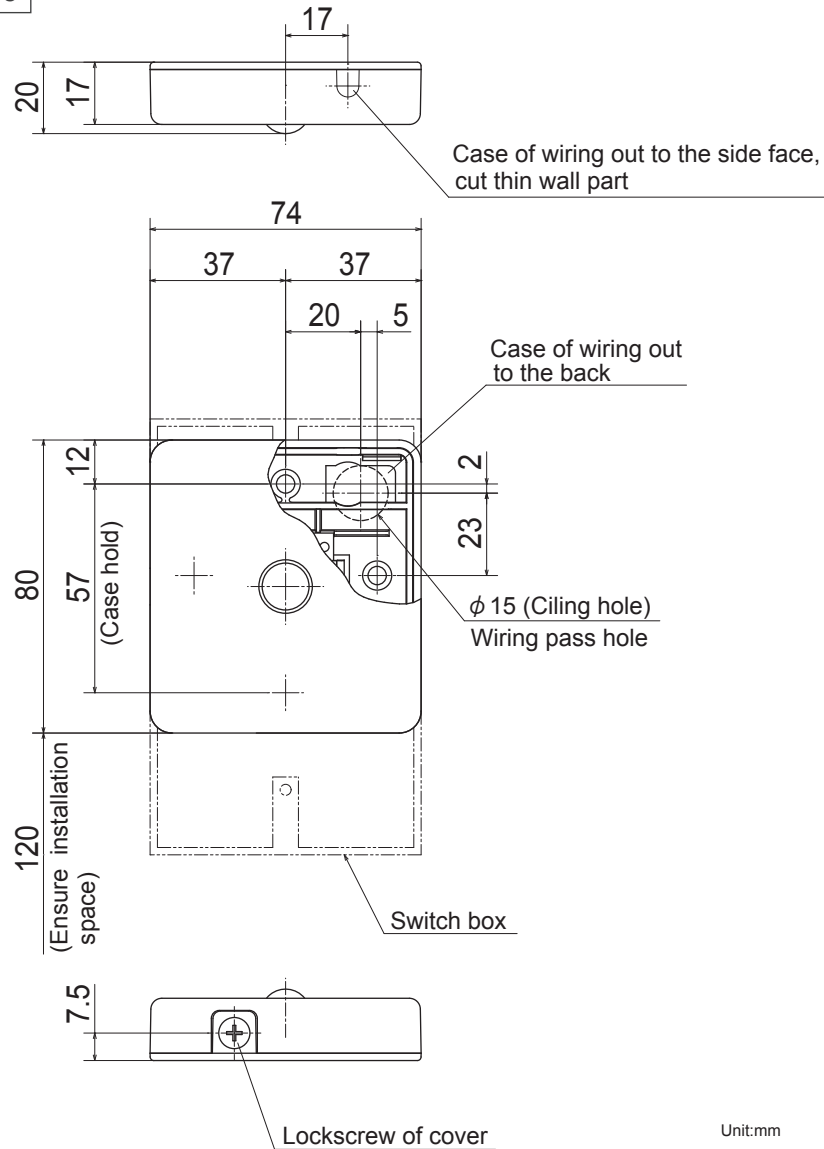

Unit:mm

Detectable area

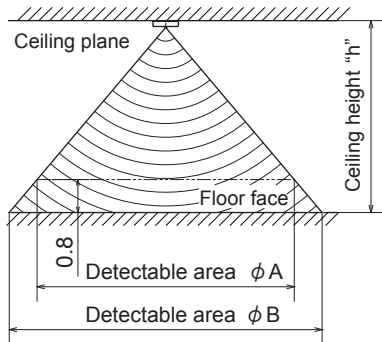

Notes

- (1) The recommended height, is lower than 4m for motion sensor. When the installation height is higher, motion detection accuracy might be reduced.
- (2) Connention wiring (prepare on site) for signal wiring is 0.2mm² × 3 cores wire or more (Red,White,Black) and maximum total extension 8m.
- (3) Motion sensor kit can be installed on the wall, but recommend installing is the ceiling plane.
- (4) In the case of wall installation, the detectable area is 5m in front and about 100° left and right.
- (5) Refer to the installation sheet for details.

High of the ceiling h[m]	2.7	3.5	4.0
Detectable area φ A[m]	4.5	6.4	7.6
Detectable area φ B[m]	6.4	8.3	9.5

Installation precautions

Do not install the motion sensor kit at the following places in order to avoid malfunction.

- (1) Places exposed to direct sunlight
- (2) Places near heat devices
- (3) High humidity places
- (4) Hot surface or cold surface enough to generate condensation
- (5) Places exposed to oil mist or steam directly
- (6) Uneven surface
- (7) Places affected by the direct air flow of the AC unit
- (8) Places where the motion sensor is influenced by the fluorescent lamp (especially inverter type) or sunlight
- (9) Places where the motion sensor is affected by infrared rays of any other communication devices
- (10) Place that the motion sensor have a shock
- (11) Place with the strong radio wave or static electricity
- (12) Place that motion sensor lens become tainted or have damaged. Dusty place
- (13) Do not run in parallel with strong voltage lines such as power source wiring

Wiring connection

<In case of CnL connector is on PCB>

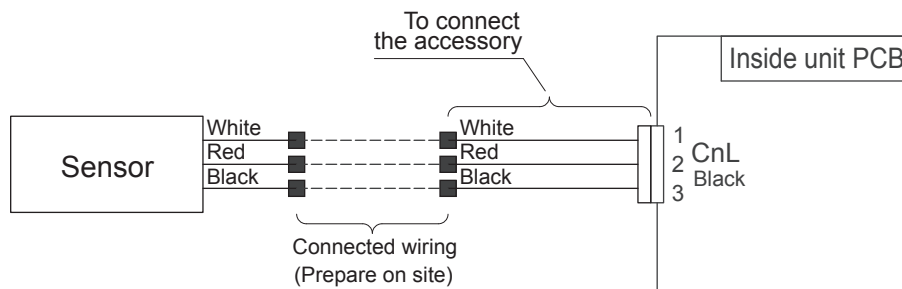

<In case of CnL connector is not on PCB>

(In case of "DC motor")

[Refer to Note (5)]

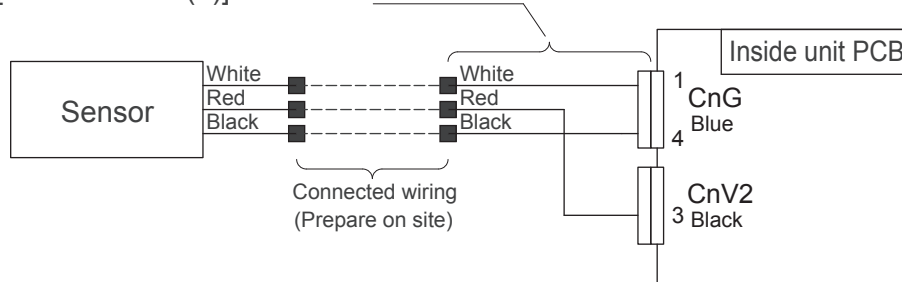

<In case of CnL connector is not on PCB>

(In case of "AC motor")

[Refer to Note (5)]

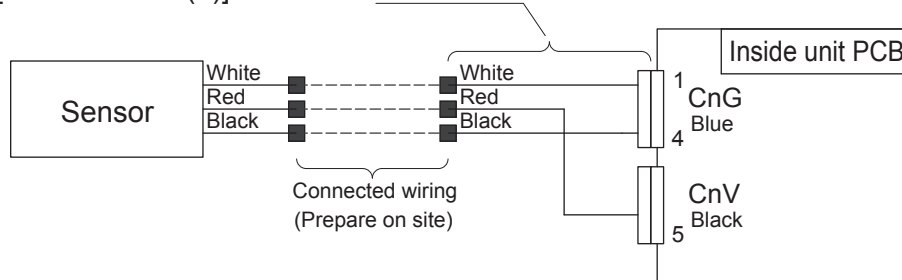

(b) Installation manual

PJZ012D134

⚠ WARNING

● Connect the wiring to the PCB in the control box on the indoor unit and hold the wiring securely so as not to apply unexpected stress on the PCB.
Loose connection or hold will cause abnormal heat generation or fire.



● Make sure the power source is turned off when electric wiring work.
Otherwise, electric shock, malfunction and improper running may occur.



⚠ CAUTION

● Do not install the motion sensor kit at the following places in order to avoid malfunction.

- | | |
|--|--|
| (1) Places exposed to direct sunlight | (8) Places where the motion sensor is affected by infrared rays of any other communication devices |
| (2) Places near heat devices | (9) Places where some object may obstruct the motion sensor |
| (3) High humidity places | (10) Place that the motion sensor have a shock |
| (4) Hot surface or cold surface enough to generate condensation | (11) Place with the strong radio wave or Static electricity |
| (5) Places exposed to oil mist or steam directly | (12) Place that motion sensor lens become tainted or have damaged. Dusty place |
| (6) Places affected by the direct air flow of the Indoor unit | (13) Place where it runs in parallel with strong voltage lines such as power source wiring |
| (7) Places where the motion sensor is influenced by the fluorescent lamp or sunlight | |



● Do not leave the motion sensor without the cover.

In case the cover needs to be detached, protect the motion sensor with a packaging or bag in order to keep it away from water and dust.









Attention

- This manual describes how to install the motion sensor kit.
- Instruct the customer how to operate it correctly referring to the instruction manual.
- For the installation method of the air-conditioner itself, refer to the installation manual enclosed in the package.

① Accessories

Please make sure that all components are in the package.

Motion sensor	Wiring <1>	Wiring <2>	Wiring <3>	2 screws	Manual
	In case of CnL connector on the indoor unit PCB (FDT/FDK/FDTC) 	In the case of CnV2 connector on the indoor unit PCB 	In the case of CnV connector on the indoor unit PCB (FDTQ/FDFL/FDFU) 		

⚠ Please prepare a relay wiring for connecting the motion sensor and indoor unit on site. (0.2mm² or thicker, triplex (red, white and black) cable for communication, with the maximum length of 8m.)

② Installing the motion sensor

- The recommended height is lower than 4000mm for motion sensor. When the installation height is higher, motion detection accuracy might be reduced.
- Sensor will detect the object with a different temperature from the surrounding.
- Motion sensor is more sensitive to motions in the direction of ⇄ mark.
- Sensor may not detect small children or infants with little motion.
- Although motion sensor can be installed on a wall, it is recommended to install it on the ceiling plane.
- If the sensor is installed on the wall, the sensing distance in the front direction is about 5m, covering the angle of about 100 degrees.

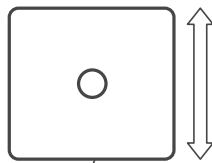

Side of screws for fixing the case

The detectable area

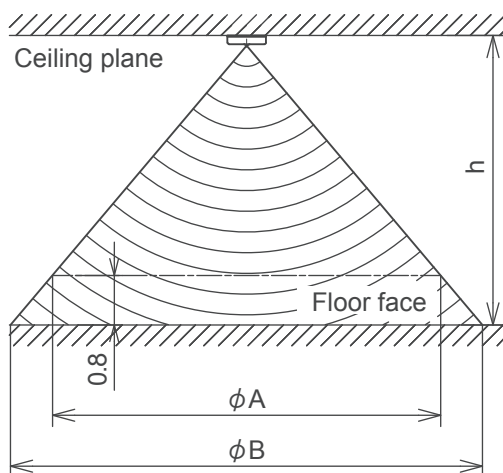

Height of the ceiling	h (m)	2.7	3.5	4.0
Detectable area	φ A (m)	4.5	6.4	7.6
Detectable area	φ B (m)	6.4	8.3	9.5

Installing the motion sensor

There are the following 3 methods to install the motion sensor on the ceiling plane or wall surface (hereinafter called "ceiling plane"). Select the method according to the installation position.

<How to install>

- Direct installation by screws to the ceiling plane with the wiring in the ceiling space.**
- Direct installation by screws to the ceiling plane with the wiring in the room.**
- Installation with switch box (prepare at the site)**

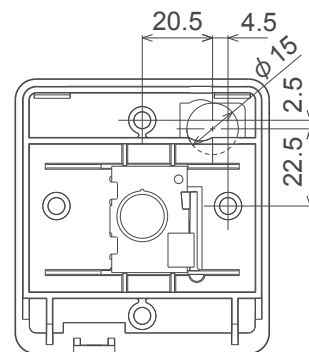

Positional relation for pulling out relay wiring hole and installing holes.

Option (A)

►Select this method if the ceiling plane has sufficient strength to install the motion sensor directly with screws.

- ① Prepare a relay wiring on site and lay out the wiring in advance.
- ② Remove the screw at the side of the motion sensor and slide the upper case in the direction of the arrow.
- ③ Pull the wiring of the motion sensor as below.

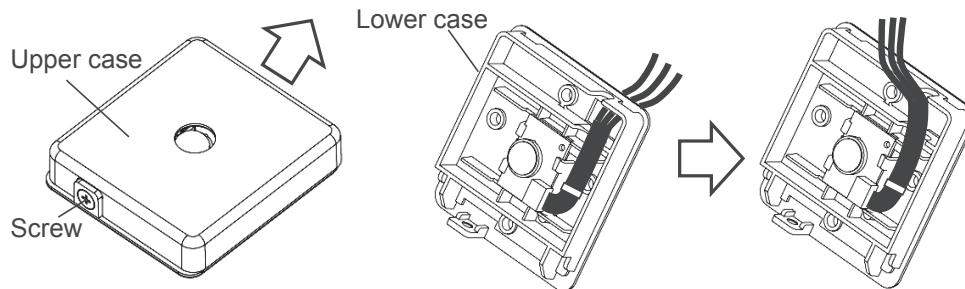
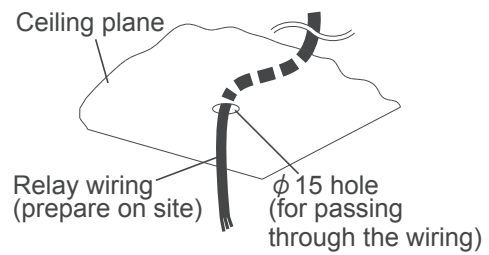

- ④ Pass the relay wiring through the hole on the lower case.
- ⑤ When fixing the lower case to the ceiling plane, tighten it in 2 locations of the installing holes (4 locations) with the attached screws.

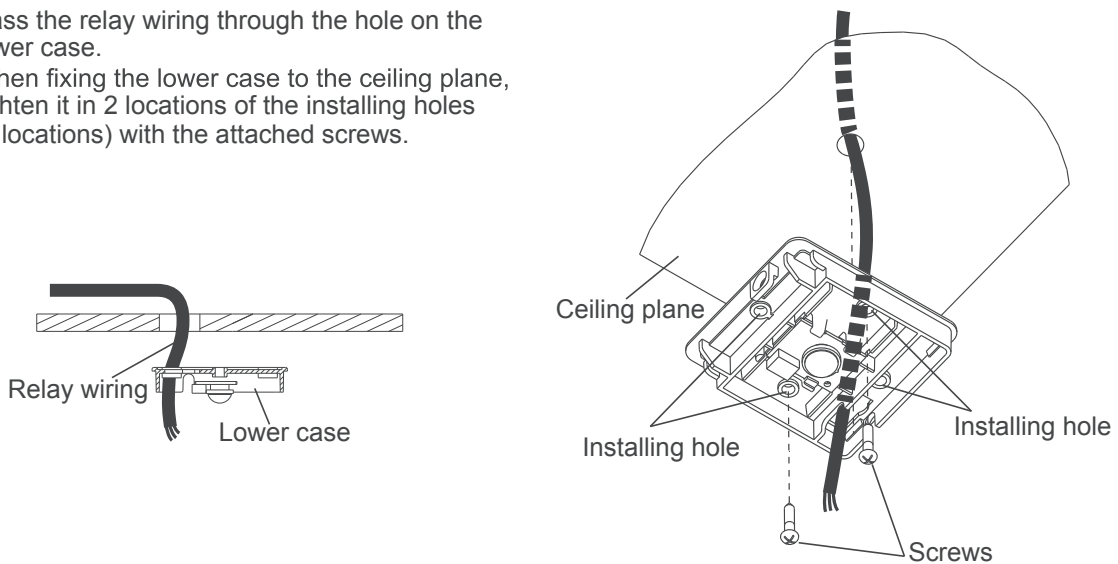

- ⑥ Using a crimping terminal, etc., connect the same color to the relay wiring (prepare on site) and the wiring of motion sensor.

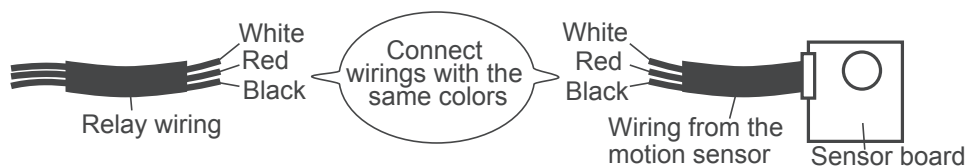

- ⑦ Place the connecting part inside of the ceiling space.
- ⑧ Seal the wiring hole on the lower case with putty.
- ⑨ Taking care not to pinch the wirings, slip the upper case into the lower case, and tighten the screws.

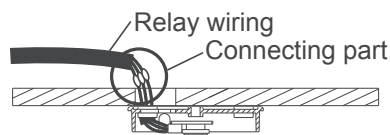

Caution:
In order to prevent tracking, be sure to perform construction so as not to clog up the connecting part with dust, etc.

Option (B)

► Select this method if the ceiling plane has sufficient strength to install the motion sensor directly with screws.

- ① Remove the screw at the side of the motion sensor and slide the upper case in the direction of the arrow.
(The same as ② of Option (A))
- ② Pull the wiring of the motion sensor toward the side. Cut off the thinner part of the upper case.

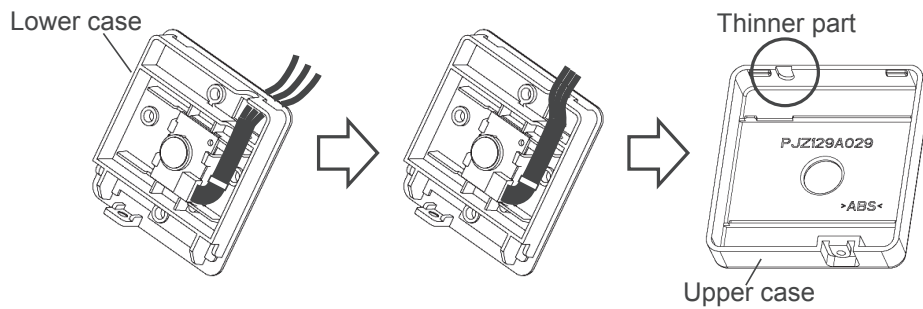

- ③ When fixing the lower case to the ceiling plane, tighten it in 2 locations of the installing holes (4 locations) with the attached screws. (The same as ⑤ of Option (A))
- ④ Using a crimping terminal, etc., connect the same color to the relay wiring (prepare on site) and the wiring of motion sensor.
(The same as ⑥ of Option (A))
- ⑤ Taking care not to pinch the wirings, slip the upper case into the lower case, and tighten the screws.
(The same as ⑨ of Option (A))
- ⑥ Seal the cut part at Step ② with putty.

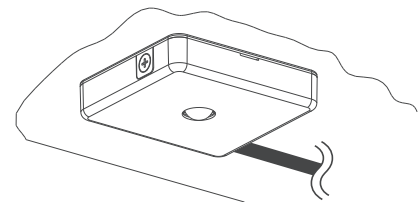

Option (C)

- ① Set up the switch box and relay wiring (prepare on site) in advance.
Seal the relay wiring inlet with putty.

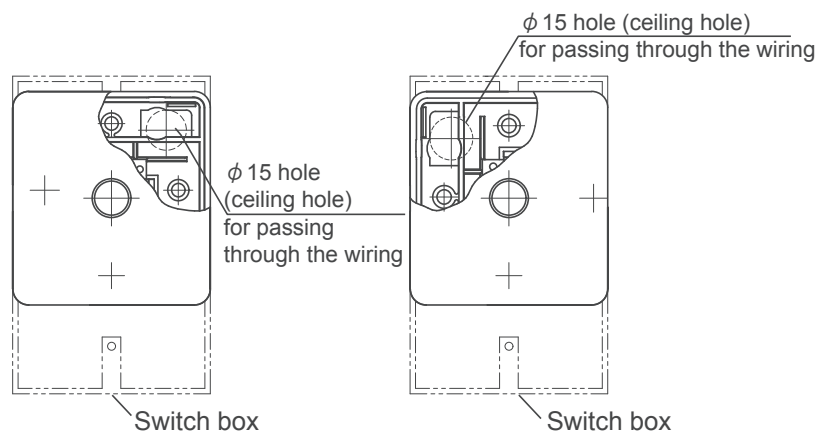

Positional relation for the switch box and installing holes

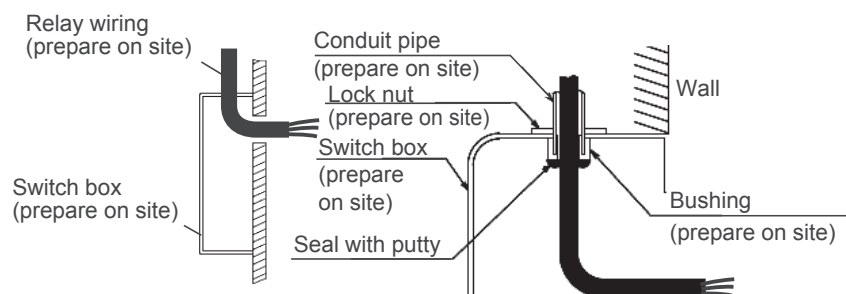

- ② Remove the screw at the side of the motion sensor and slide the upper case in the direction of the arrow.
(The same as ② of Option (A))
- ③ Pull the wiring of the motion sensor.
(The same as ③ of Option (A))
- ④ Pass the relay wiring through the hole on the lower case from switch box.
- ⑤ Fix the lower case to switch box using the installing hole (1 place).
- ⑥ Connect the same color to the relay wiring (prepare on site) and the wiring of motion sensor.
(The same as ⑥ of Option (A))
- ⑦ Place the connecting part between switch box and the hole of the lower case through passed the wiring at step ④ .
- ⑧ Taking care not to pinch the wirings, slip the upper case into the lower case, and tighten the screws.
(The same as ⑨ of Option (A))

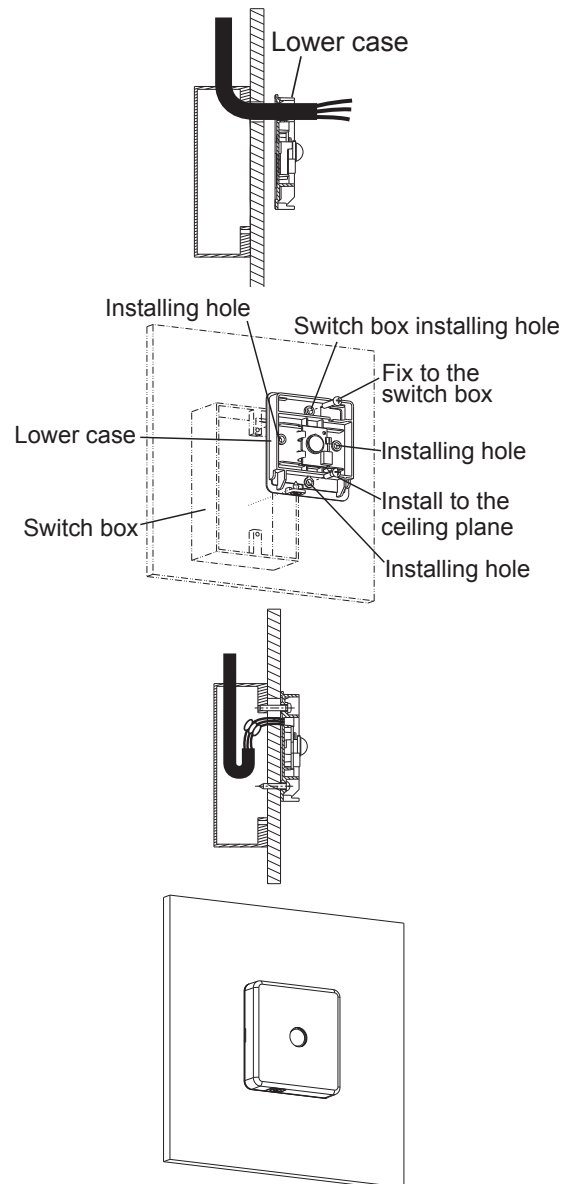

Wiring connection in the control box of indoor unit

CAUTION: Attached wirings to the motion sensor vary depending on the model of the indoor unit.
Make sure your model before installing.

<In case of the CnL connector is on the indoor unit PCB (FDT/FDK/FDTC)>

- ① Connect the same color to the relay wiring (prepare on site) and the attached wiring <1>.
- ② Remove the control box cover from the indoor unit.
- ③ Connect CnL connector (3P, black) to the PCB.

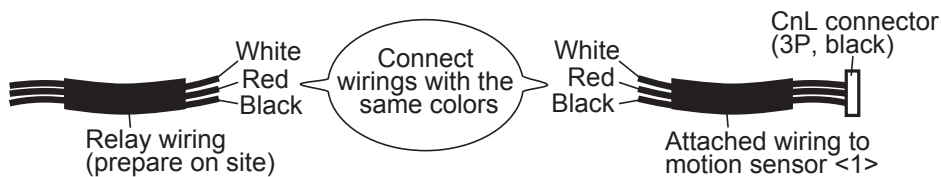

<In the case of CnV2 connector on the indoor unit PCB>

- ① Connect the same color to the relay wiring (prepare on site) and the attached wiring <2>.
- ② Remove the control box cover from the indoor unit.
- ③ Connect CnG connector (4P, blue) to the PCB.
- ④ Connect CnV2 connector (4P, black) to the PCB.

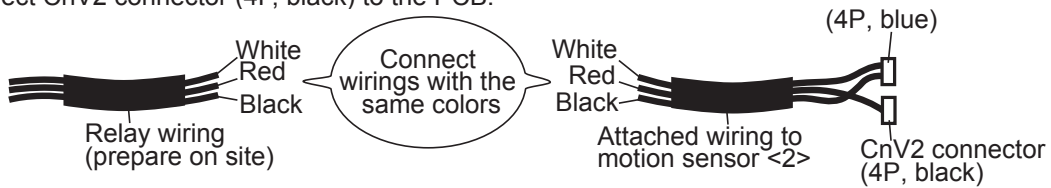

<In case of the CnV connector is not on the indoor unit PCB (FDTQ/FDFL/FDFU)>

- ① Connect the same color to the relay wiring (prepare on site) and the attached wiring <3>.
- ② Remove the control box cover from the indoor unit.
- ③ Connect CnG connector (4P, blue) to the PCB.
- ④ Connect CnV connector (5P, black) to the PCB.

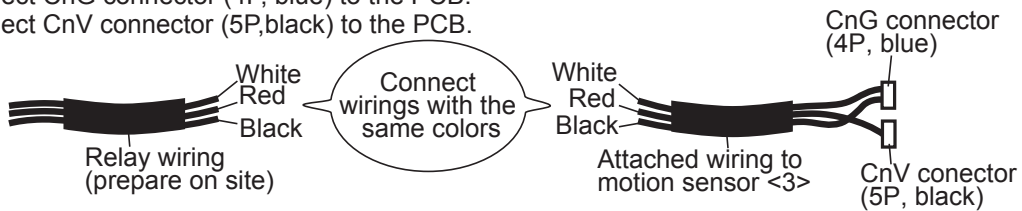

<For FDT>

<For FDTC>

<For FDK>

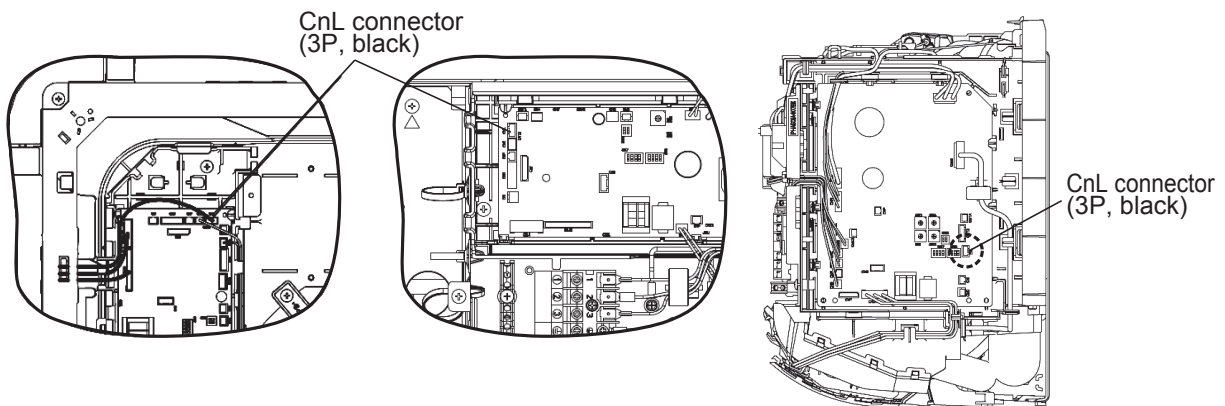

<For the other indoor units>

<In case of FDTQ/FDFL/FDFU>

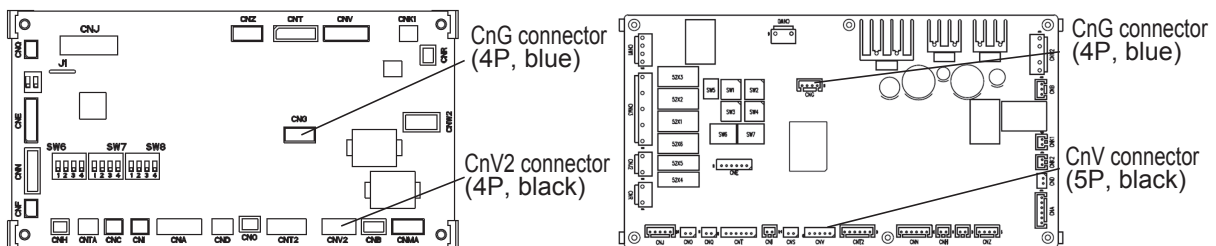

③ Setting the motion sensor

The motion sensor will not function if it is only installed.
 Set the function of the motion sensor by the wired or wireless remote control.
 Refer to the manual instruction of each remote control for the setting procedure.

Note: It is not possible to set by the following remote control models or older.

Wired: RC-EX1A, RC-E5, RCH-E3

Wireless: RCN-E1R

(3) FDE series (LB-E)

(a) Specification

Motion sensor kit

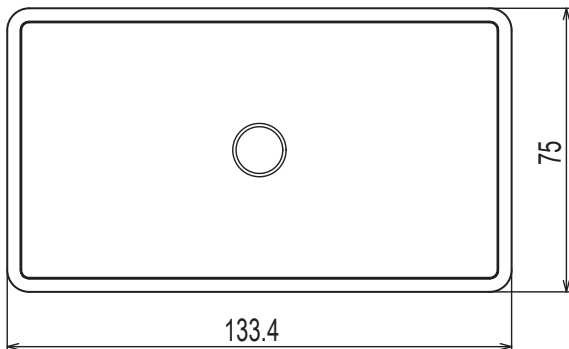

Installation position of motion sensor kit

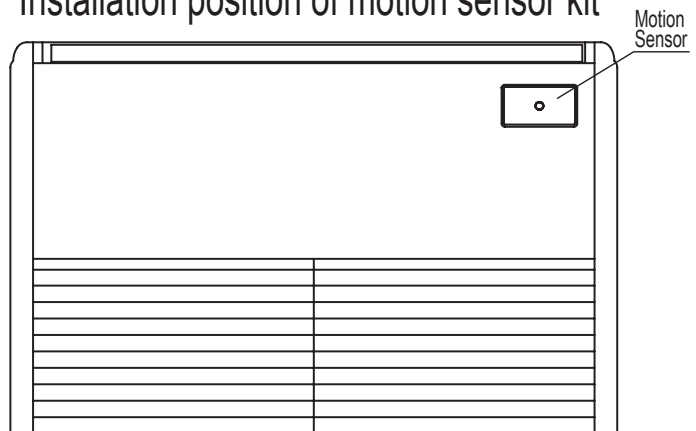

Note

1. The recommended height, is lower than 4m for motion sensor.
- When the installation height is higher, motion detection accuracy might be reduced.

Installation of motion sensor kit

DO NOT install the motion sensor kit at the following places in order to avoid malfunction.

- (1) Places exposed to direct sunlight
- (2) Places near heat devices
- (3) High humidity places
- (4) Hot surface or cold surface enough to generate condensation
- (5) Places exposed to oil mist or steam directly
- (6) Uneven surface
- (7) Places affected by the direct airflow of the AC unit
- (8) Places where the motion sensor is influenced by the fluorescent lamp (especially inverter type) or sunlight
- (9) Places where the motion sensor is affected by infrared rays of any other communication devices
- (1 0) Place that the motion sensor have a shock
- (1 1) Place with the strong radio wave or static electricity
- (1 2) Place that motion sensor lens become tainted or have damaged. Dusty place.

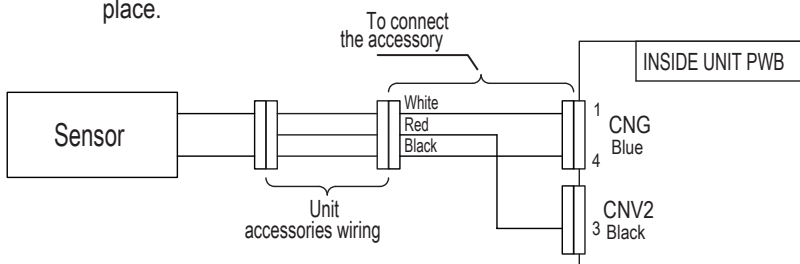
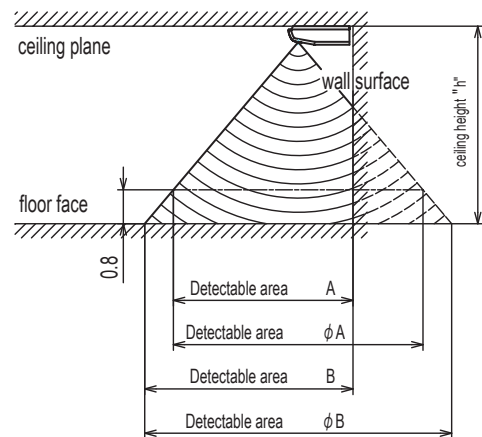



High of the ceiling	h[m]	2.7	3.5	4.0
Detectable area	A[m]	2.9	3.9	4.5
Detectable area	ϕA [m]	4.5	6.4	7.6
Detectable area	B[m]	3.9	4.8	5.4
Detectable area	ϕB [m]	6.4	8.3	9.5

PFA004Z077

(b) Installation manual



PFA012D633 

 **WARNING**

- Connect the wiring to the PCB in the control box on the indoor unit and hold the wiring securely so as not to apply unexpected stress on the PCB. Loose connection or hold will cause abnormal heat generation or fire. 
- Make sure the power source is turned off when electric wiring work. Otherwise, electric shock, malfunction and improper running may occur. 

 **CAUTION**

- Do not install the motion sensor kit at the following places in order to avoid malfunction.



<ul style="list-style-type: none"> (1) Places exposed to direct sunlight (2) Places near heat devices (3) High humidity places (4) Hot surface or cold surface enough to generate condensation (5) Places exposed to oil mist or steam directly (6) Places affected by the direct air flow of the Indoor unit (7) Places where the motion sensor is influenced by the fluorescent lamp or sunlight 	<ul style="list-style-type: none"> (8) Places where the motion sensor is affected by infrared rays of any other communication devices (9) Places where some object may obstruct the motion sensor (10) Place that the motion sensor have a shock (11) Place with the strong radio wave or Static electricity (12) Place that motion sensor lens become tainted or have damaged. Dusty place
---	--
- Do not leave the motion sensor without the cover. In case the cover needs to be detached, protect the motion sensor with a packaging or bag. In order to keep it away from water and dust. 

Attention

- This manual describes how to install the motion sensor kit.
- Instruct the customer how to operate it correctly referring to the instruction manual.
- For the installation method of the air-conditioner itself, refer to the installation manual enclosed in the package.

① Accessories

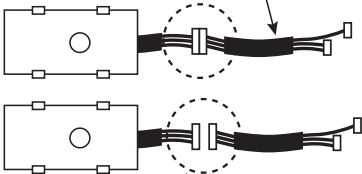
Please make sure that all components are in the package.

Motion sensor (※)	Manual
<p>Attached wiring to the motion sensor kit</p>  <div style="border: 1px solid black; padding: 5px; margin-top: 10px;"> <p>※ Wiring from the motion sensor and the attached wiring to the motion sensor kit have been connected when shipped from the factory. Remove the connector at the position of ○ mark and connect it to the attached wiring to the indoor unit before use.</p> </div>	

② Installing the motion sensor

- It is possible to install the motion sensor by replacing the indoor unit.
- The recommended height is lower than 4000mm for motion sensor. When the installation height is higher, motion detection accuracy might be reduced.
- Sensor will detect the object with a different temperature from the surrounding.
- Sensor may not detect small children or infants with little motion.
- Use the separate motion sensor so that person's activity can be detected when the detectable area differs from the person's activity area.
- Use the separate motion sensor when using both wireless remote control and motion sensor together.

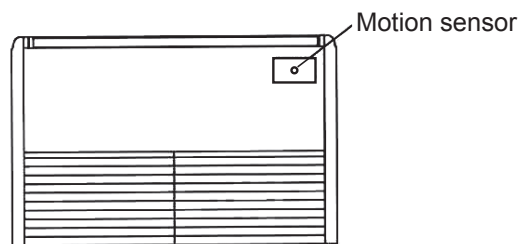

The detectable area

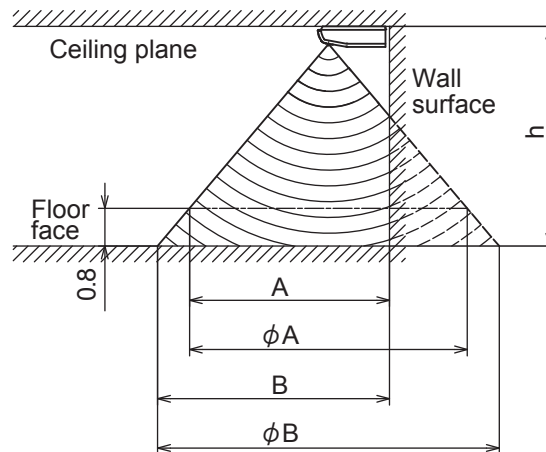

Height of the ceiling	h (m)	2.7	3.5	4.0
Detectable area	A (m)	2.9	3.9	4.5
Detectable area	ϕ A (m)	4.5	6.4	7.6
Detectable area	B (m)	3.9	4.8	5.4
Detectable area	ϕ B (m)	6.4	8.3	9.5

Installing the motion sensor (before installing the unit)

Motion sensor can be installed by replacing with a cover of the panel.

CAUTION: Install the motion sensor before installing the unit.

When installing the motion sensor after unit has been fixed, injury due to falling may result because of working at high place.

- ① Remove the connector that connects the motion sensor and the wiring.

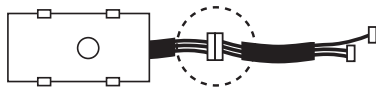

- ② Insert a tool into the dented part (2 places) of the panel cover, and wrench slightly not to damage the paintwork of the panel to remove the cover.
- ③ Connect the wiring from the panel's hole (attached to the indoor unit, color of the wiring: white, red and black, connector: 3P, white) to the wiring from the motion sensor. Make sure to install the motion sensor in the correct direction.

CAUTION: Do not remove the clamp fixed the wiring.

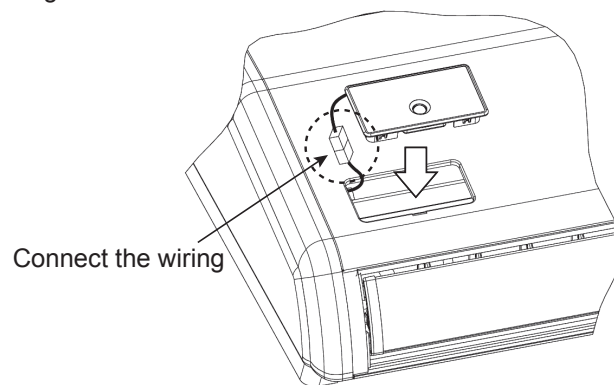
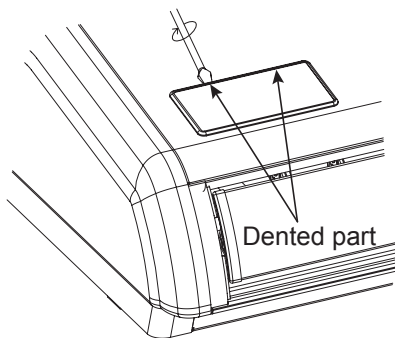

- ④ Install the motion sensor
Place the connector under the panel and install it to the panel with careful attention to the direction of the motion sensor.

CAUTION: Connect the connectors before installing the motion sensor.

In case of connecting after the motion sensor has been installed, it will be necessary to remove the panel.

Wiring connection in the control box

- ① Connect the wiring from the motion sensor (attached to the indoor unit, color of the wiring: white, red and black, connector: 3P, white) to the attached wiring to the motion sensor kit.
- ② Fix the wiring with clips (6 places).
- ③ Connect CnG connector (4P, blue) to the PCB.
- ④ Connect CnV2 connector (4P, black) to the PCB.

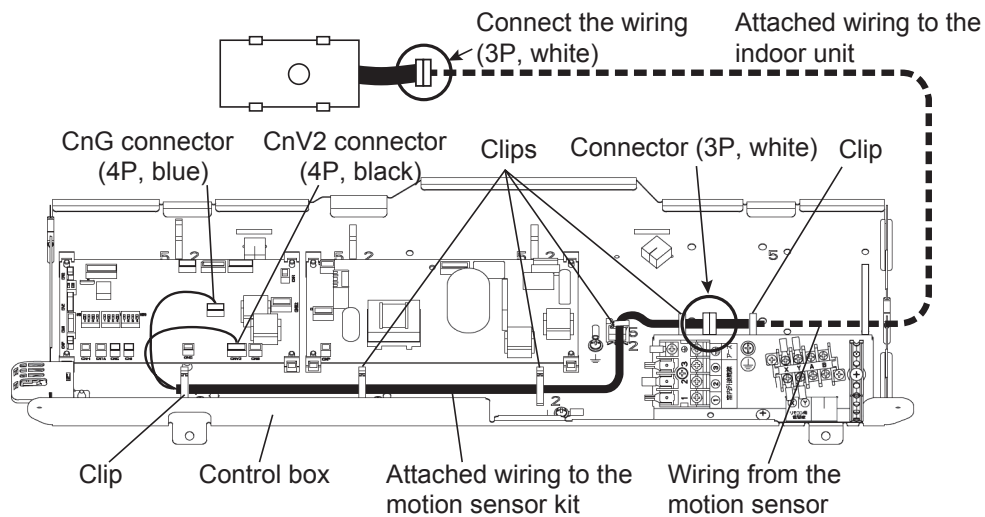

③ Setting the motion sensor

The motion sensor will not function if it is only installed.

Set the function of the motion sensor by the wired or wireless remote control. Refer to the manual instruction of each remote control for the setting procedure.

Note: It is not possible to set by the following remote control models or older.

Wired: RC-EX1A, RC-E5, RCH-E3

Wireless: RCN-E1R

SAFETY PRECAUTIONS

⚠ WARNING

- **If a child, person with disease or other persons needed for assist uses this product, people around the person should take sufficient care.** !
- A halt of the air-conditioner due to abnormal situation or motion sensor's control may cause a feeling of sickness or accident.

ATTENTION

- The sensor may not detect a person near the border of detection range.
- Installation near an object with a different temperature from the surrounding may cause a false detection of human.
- Due to correction of temperature setting, some people may feel chilly.

This product uses infrared sensor to detect person's activity level to support control of air-conditioner. Please set the control you like from the remote control.

Indoor unit control	Detective situation	Description of control	Display of eco touch remote control
① Power control	Activity level is large	Lower the indoor temperature setting for comfort.	Power control ON
	Activity level is small	Raise the indoor temperature setting for energy-saving.	Power control ON
② Auto-off	No one is detected for 1 hour	Stop operation and stand by	In auto-off mode
	No one is detected for 12 hours	Stop operation	-
① + ②	Any combination of the above	Any of the above	Any of the above
All disabled (default setting)	-	Standard control	-

If the sensor is disconnected or defective, the control will be set as if it no detects (or less) activity level.

Refer to the next section for setting method.

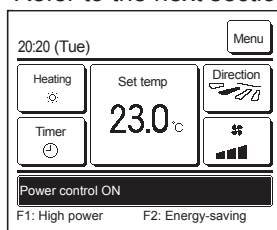

- **When power control is enabled**
 The amount of human motion is detected by a motion sensor to adjust the Set temperature. (The set temperature of remote control is displayed at the adjusted temperature.)
 in cooling : 33 °C, in heating : 15 °C
 adjust the set temperature step by step up to above temperature.
 During power control, "Power control ON" will be displayed on the message display.

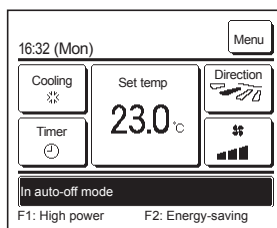

- **When auto-off is enabled**
 The unit will enter the "operation wait" state when an hour has elapsed since the last time a human presence was detected.
 And will be in "complete stop" state after 12 hour of operation wait time.
 "Operation wait"...The unit stops but will resume operation when human presence is detected. When the unit is in "Complete stop", "In auto-off mode" will be displayed on the message display.
 "Complete stop"...When auto-off is enabled, the unit stops. The unit will not resume operation even when human presence is detected.
 The message "In auto-off mode" will disappear from the message display, and the operation lamp will turn off.

Control setting (from eco touch remote control)

- Refer to the installation manual for eco touch remote control to activate the infrared sensor (motion sensor).
TOP screen **Menu** ⇒ **Service setting** ⇒ **Installation settings** ⇒ **Service password**

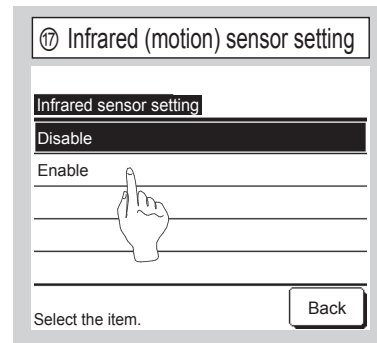
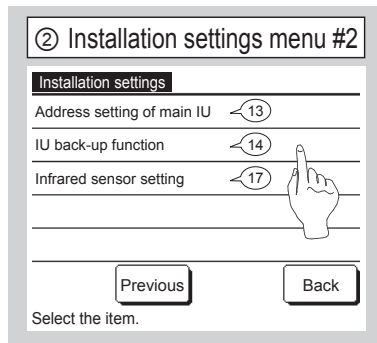
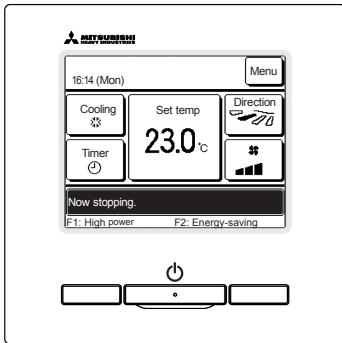

- Refer to the installation manual for eco touch remote control to set control mode.
 - Infrared sensor (motion sensor) control (for IUs with motion sensors)
Presence of humans and the amount of motion are detected by a motion sensor to perform various controls.
 - When the R/C is set as the sub R/C, the infrared sensor (motion sensor) control cannot be set.

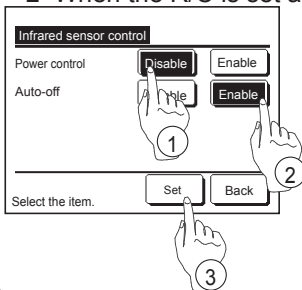

Tap the **Menu** button on the TOP screen and select **Energy-saving setting** ⇒ **Infrared sensor control** or **Motion sensor control**.

The Infrared sensor control screen and contents of the current settings are displayed.

- ① Enable/disable power control.
- ② Enable/disable auto-off.
- ③ After you set each item, tap the **Set** button.
The display returns to the Energy-saving setting menu screen.

* This control will not be executed unless ③ is performed.

Control setting (from wireless remote control)

- Refer to the installation manual for wireless remote control to enable motion sensor in **Indoor function settings**

Indoor function settings

1. How to set indoor functions

- ① Press the ON/OFF button to stop the unit.
- ② Press the desired one of the buttons shown item 2. while holding down the FUNCTION SETTING switch.
- ③ Use the selection buttons, ▲ and ▼, to change the setting.
- ④ Press the SET button.

The buzzer on the remote control signal receiver beeps twice, and the LED lamp flashes four times at two-second intervals.

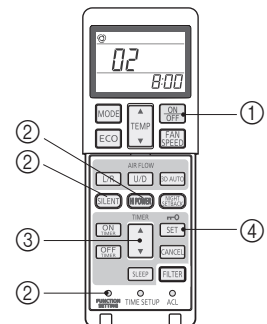

2. Setting details

Button	Number indicator	Function setting
SILENT	00	Infrared sensor setting (Motion sensor setting) : Disable
	01	Infrared sensor setting (Motion sensor setting) : Enable
HI POWER	00	Infrared sensor control (Motion sensor control) : Disable
	01	Infrared sensor control (Motion sensor control) : Power control only
	02	Infrared sensor control (Motion sensor control) : Auto OFF only
	03	Infrared sensor control (Motion sensor control) : Power control and Auto OFF

8.5 Interface kit (SC-BIKN2-E)

RKZ012A099

Accessories included in package

Be sure to check all the accessories included in package.

No.	Part name	Quantity
①	Indoor unit's connection cable (cable length: 1.8m)	1
②	Wood screws (for mounting the interface: ø4x25)	2
③	Tapping screws (for the cable clamp and the interface mounting bracket)	3
④	Interface mounting bracket	1
⑤	Cable clamp (for the indoor unit's connection cable)	1
⑥	CnT terminal connection cable (total cable length: 0.5m)	1

Safety precautions

Before use, please read these Safety precautions thoroughly before installation.

- All the cautionary items mentioned below are important safety related items to be taken into consideration, so be sure to observe them at all times.

Warning Incorrect installation could lead to serious consequences such as death, major injury or environmental destruction.

- Symbols used in these precautions

! Always go along these instruction.

- After completed installation, carry out trial operation to confirm no anomaly, and ask the user to keep this installation manual in a good place for future reference.

Warnings



- **Installation must be carried out by a qualified installer.**
If you install it by yourself, it may cause an electric shock, fire and personal injury, as a result of a system malfunction.
- **Install it in full accordance with the installation manual.**
Incorrect installation may cause an electric shock, fire and personal injury.
- **Electrical work must be carried out by a qualified electrician in accordance with the technical standard for electrical equipment, the indoor wiring standard and this installation manual.**
Incorrect installation may cause an electric shock, fire and personal injury.
- **Use the specific cables for wiring. And connect all the cables to terminals or connectors securely and clamp them with cable clamps in order for external forces not to be transmitted to the terminals directly.**
Incomplete connection may cause malfunction, and lead to heat generation and fire.
- **Use the original accessories and specified components for installation.**
If the parts other than those prescribed by us are used, it may cause an electric shock, fire and personal injury.

Connecting the indoor unit's connection cable to the interface

- ① Remove the upper case of the interface.
 - Remove 2 screws from the interface casing before removal of upper casing.
- ② Connect the indoor unit's connection cable to the interface.
 - Connect the connector of the indoor unit connection cable to the connector on the interface's circuit board.
- ③ Fix the indoor unit's connection cable with the cable clamp.
 - Cable can be brought in from the top or from the back.
 - Cut out the punch-outs for the connection cables running into the casing with cutter.
- ④ Connect the indoor unit's connection cable to the indoor control PCB.
 - Connect the indoor unit's connection cable to the indoor control PCB securely.
 - Clamp the connection cable to the indoor control box securely with the cable clamp provided as an accessory.
 - Regarding the cable connection to the indoor unit, refer to the installation manual for indoor unit.

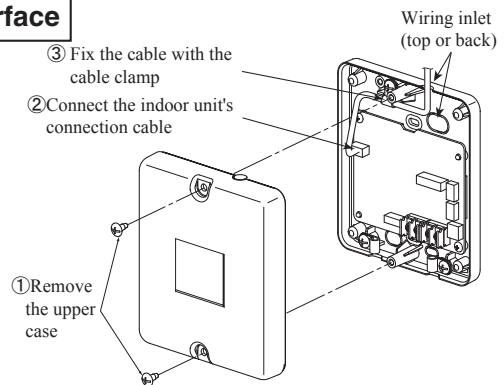

Name of each part of the interface

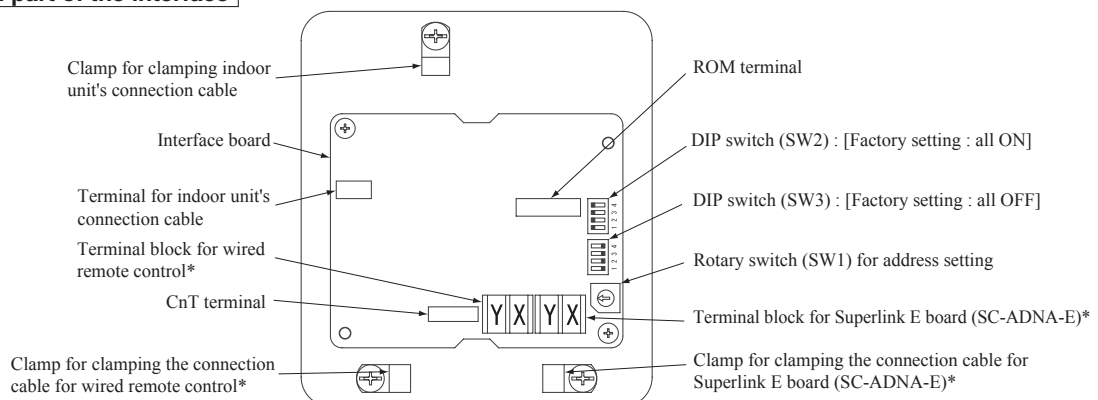

*Either the connection cables of Superlink E board (SC-ADNA-E) or of wired remote control is connectable.

Switch	Setting	Function	Switch	Setting	Function
SW2-1	ON**	CnT level input	SW2-3	ON**	External input (CnT input)
	OFF	CnT pulse input		OFF	Operation permission/prohibition (CnT input)
SW2-2	ON**	Wired remote control : Enable	SW2-4	ON**	Annual cooling : Enable***
	OFF	Wired remote control : Disable		OFF	Annual cooling : Disable***

** Factory setting

*** Indoor fan control at low outdoor air temperature in cooling

Installation of the interface

- Install the interface within the range of the connection cable length (approximately 1.3m) from the indoor unit.
- Be sure not to extend the connection cable on site. If the connection cable is extended, malfunction may occur.
- Fix the interface on the wall, pillar or the like.

● Don't install the interface and wired remote control at the following places.

- Places exposed to direct sunlight
- Places near heating devices
- High humidity places
- Surfaces where are enough hot or cold to generate condensation
- Places exposed to oil mist or steam directly
- Uneven surface

Mounting the interface directly on a wall

- ① Mount the lower casing of the interface on a flat surface with wood screws provided as standard accessory.
- ② Mount the upper casing.

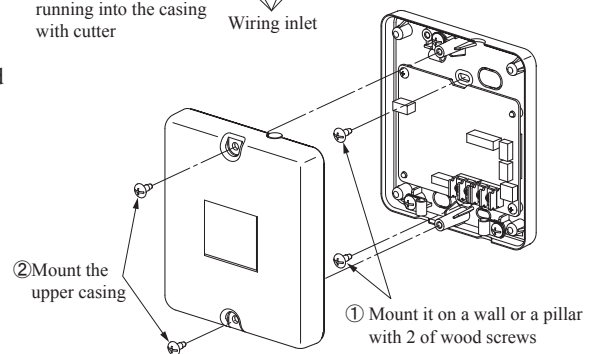
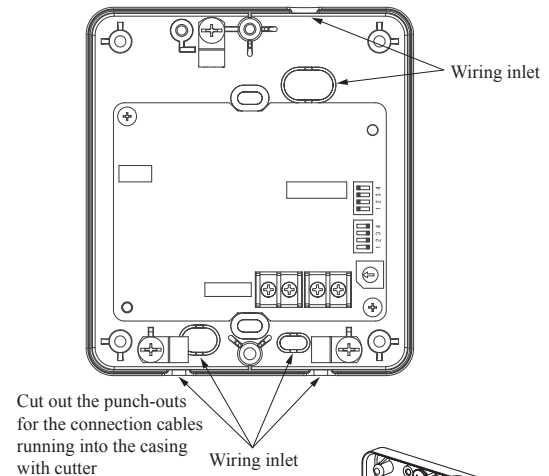

Recessing the interface in the wall

- ① Recess the electrical box (procured locally) and connection cables in the wall.
- ② Mount the lower casing of the interface to the electrical box with M4 screws (procured locally).
- ③ Mount the upper casing.

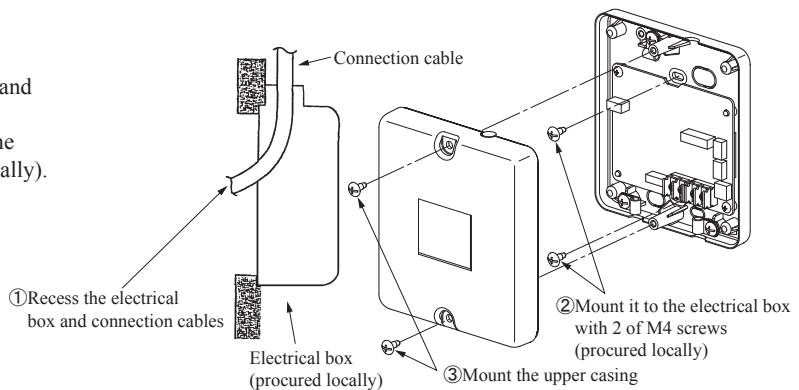

Mounting the interface with the mounting bracket

- ① Mount the upper casing.
- ② Mount the mounting bracket to the interface with tapping screws provided as standard accessory.
- ③ Mount the mounting bracket on wall or the like with wood screws provided as standard accessory.

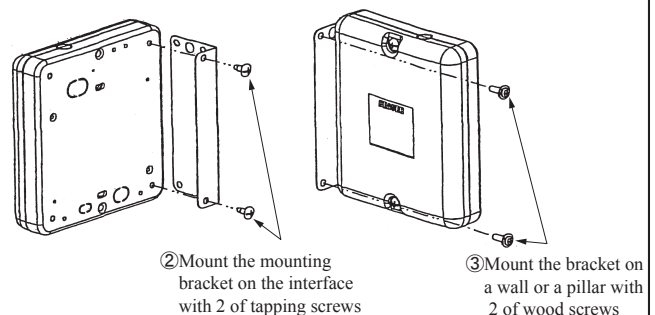

Installation check items

- Are the connection cables connected securely to the terminal blocks and connectors?
- Are the thickness and length of the connection cables conformed with the standard?

Functions of CnT connector

It is available to operate the air-conditioner and to monitor the operation status with the external control unit (remote display) by sending the input/output signal through CnT connector on the indoor control PCB.

- ① Connect a external remote control unit (procured locally) to CnT terminal.
- ② In case of the pulse input, switch OFF the DIP switch SW2-1 on the interface PCB.
- ③ When setting operation permission/prohibition mode, switch OFF the DIP switch SW2-3 on the interface PCB.

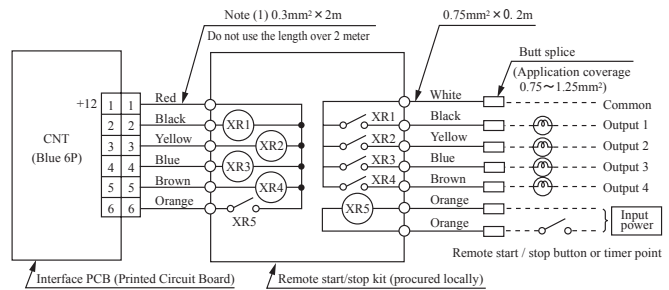

Input/Output	Function	Output signal		Content
		Relay	ON/OFF	
Output 1	Operation output	XR1	ON	During air-conditioner operation
Output 2	Heating output	XR2	ON	During heating operation
Output 3	Compressor operation output	XR3	ON	During compressor running
Output 4	Malfunction output	XR4	ON	During anomalous stop

- XR1-4 are for the DC 12V relay
- XR5 is a DC 12/24V or AC 220-240V relay
- CnT connector (local) maker, model

Connector	Molex	5264-06
Terminals	Molex	5263T

Input/Output	Function	SW2-1		SW2-3		Air-conditioner	Operation by remote control				
		Setting		Input signal	Content						
Input	External control input	ON*	Level input	ON*		Level	OFF→ON	External input	ON	Allowed	
					Level	ON→OFF	Operation permission	OFF			
				Level	OFF→ON	Operation permission	OFF	Not allowed			
				Level	ON→OFF	Operation prohibition	OFF				
		OFF	Pulse input	ON*	Pulse	ON*	Level	OFF→ON	External input	OFF→ON	Allowed
							Level	ON→OFF	Operation permission	ON	
				Level	OFF→ON	Operation permission	ON	Not allowed			
				Level	ON→OFF	Operation prohibition	OFF				

* Factory setting

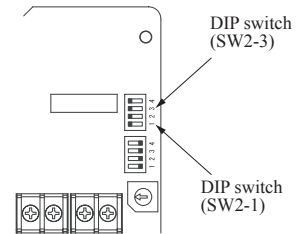

In case of the eco touch remote control (RC-EX3 or later model), the external outputs (1 – 4) and the external input can be changed using the function setting of eco touch remote control. For the setting method, refer to the installation manual. Also refer to the technical manual to know how it is adapted to the function setting for the external outputs and input, at the indoor unit side.

Connection of Superlink E board

Regarding the connection of Superlink E board, refer to the installation manual of Superlink E board.

For electrical work, power source for all of units in the Superlink system must be turned OFF.

- ① Switch ON the DIP switch SW2-2 (Factory setting: ON) on the interface PCB.

Caution: Wireless remote control attached to the indoor unit can be used in parallel, after connecting the wired remote control. However, some of functions other than the basic functions such as RUN/STOP, temperature setting, etc. may not work properly and may have a mismatch between the display and the actual behavior.

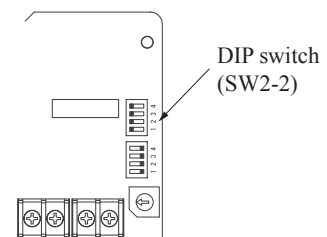

- ② Wiring connection between the interface and the Superlink E board.

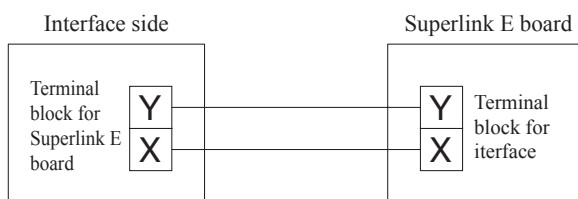

No.	Names of recommended signal wires
1	Shielded wire
2	Vinyl cabtyre round cord
3	Vinyl cabtyre round cable
4	Vinyl insulated wire vinyl sheathed cable for control

Within 200m 0.5mm² × 2 cores
 Within 300m 0.75mm² × 2 cores
 Within 400m 1.25mm² × 2 cores
 Within 600m 2.0mm² × 2 cores

- ③ Clamp the connection cables with cable clamps.

Connection of wired remote control

Regarding the connection of wired remote control, refer to the installation manual of wired remote control.

① Switch ON the DIP switch SW2-2 (Factory setting : ON) on the interface PCB.

Caution: Wireless remote control attached to the indoor unit can be used in parallel, after connecting the wired remote control. However, some of functions other than the basic functions such as RUN/STOP, temperature setting, etc. may not work properly and may have a mismatch between the display and the actual behavior.

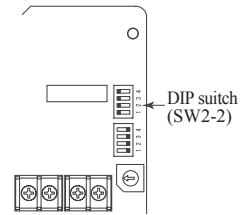

② Wiring connection between the interface and the wired remote control.

Installation and wiring of wired remote control

- Ⓐ Install the wired remote control with reference to the attached installation manual of wired remote control.
 - Ⓑ 0.3mm² × 2 cores cable should be used for the wiring of wired remote control.
 - Ⓒ Maximum length of wiring is 600m.
If the length of wiring exceeds 100m, change the size of cable as mentioned below.
100m-200m: 0.5mm² × 2 cores, 300m or less: 0.75mm² × 2 cores, 400m or less: 1.25mm² × 2 cores, 600m or less: 2.0mm² × 2 cores
However, cable size connecting to the terminal of wired remote control should not exceed 0.5mm². Accordingly if the size of connection cable exceeds 0.5mm², be sure to downsize it to 0.5mm² at the nearest section of the wired remote control and waterproof treatment should be done at the connecting section in order to avoid contact failure.
 - Ⓓ Don't use the multi-core cable to avoid malfunction.
 - Ⓔ Keep the wiring of wired remote control away from grounding (Don't touch it to any metal frame of building, etc.).
 - Ⓕ Connect the connection cables to the terminal blocks of the wired remote control and the interface securely (no polarity).
- ③ Clamp the connection cables with cable clamps.

Control of multiple units by a single wired remote control

Multiple units (up to 16) can be controlled by a single wired remote control. In this case, all units connected with a single wired remote control will operate under the same mode and same setting temperature.

- ① Connect all the interface with 2 cores cables of wired remote control line.
- ② Set the address of indoor unit for remote control communication from "0" to "F" with the rotary switch SW1 on the interface PCB.
- ③ After turning the power ON, the address of indoor unit can be displayed by pressing [AIR CON No.] button on the wired remote control.
Make sure all indoor units connected are displayed in order by pressing [▲] or [▼] button.

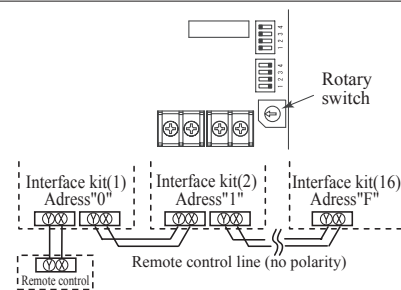

Master/Slave setting wired when 2 of wired remote control are used

Maximum two wired remote control can be connected to one indoor unit (or one group of indoor units)

- ① Set the DIP switch SW1 on the wired remote control to "Slave" for the slave remote control. (Factory setting : Master)
- Caution : Remote control sensor of the slave remote control is invalid.

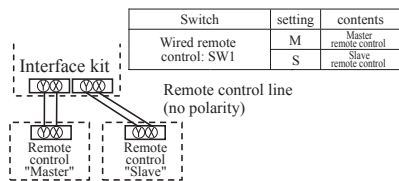

- When using the wireless remote control in parallel with the wired remote control;
Since temperature setting range of wired remote control is different from that of wireless remote control, please adjust the setting range of wired remote control to be the same setting range of wireless remote control by following procedure. (The set temperature may not be displayed correctly on the wireless remote control, unless change of temperature setting range is done.)
Changing procedure of temperature setting range is as follows.

How to set upper and lower limit of temperature setting range

1. Stop the air-conditioner, and press [○] (SET) and [▽] (MODE) button at the same time for 3 seconds or more.
The indication changes to "FUNCTION SET ▼"
2. Press [▼] button once, and change to the "TEMP RANGE ▲" indication.
3. Press [○] (SET) button, and enter the temperature range setting mode.
4. Confirm that the "Upper limit ▼" is shown on the display.
5. Press [○] (SET) button to fix.
6. ① Indication: "∅ ∇ ∆ SET UP" → "UPPER 28°C ∇ ∆"
② Select the upper limit value 30°C with temperature setting button [∇]. "UPPER 30°C ∇" (blinking)
③ Press [○] (SET) button to fix. "UPPER 30°C" (Displayed for two seconds)
After the fixed upper limit value displayed for two seconds, the indication will return to "UPPER LIMIT ▼".
7. Press [▼] button once, "LOWER LIMIT ▲" is selected, press [○] (SET) button to fix.
① Indication: "∅ ∇ ∆ SET UP" → "LOWER 20°C ∇ ∆"
② Select the lower limit value 18°C with temperature setting button [∇]. "LOWER 18°C ∆" (blinking)
③ Press [○] (SET) button to fix. "LOWER 18°C" (Displayed for two seconds)
After the fixed lower limit value displayed for two seconds, the indication will return to "LOWER LIMIT ▼"
8. Press [ON/OFF] button to finish.

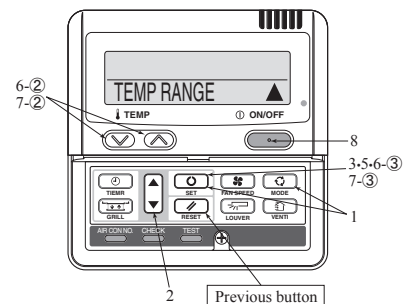

- It is possible to quit in the middle by pressing [ON/OFF] button, but the change of setting is incomplete.
- During setting, if pressing [∇] (RESET) button, it returns to the previous screen.

Mode	Temperature setting range
Cooling, Heating, Dry, Auto	18-30°C

8.6 Superlink E board (SC-ADNA-E)

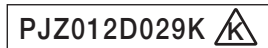

- Read and understand the instructions completely before starting installation.
- Refer to the instructions for both indoor and outdoor units.

Safety precautions

- Carefully read “Safety precautions” first. Follow the instructions for installation.
- Precautions are grouped into “Warning⚠” and “Caution⚠”. The “Warning⚠” group includes items that may lead to serious injury or death if not observed. The items included in the “Caution⚠” group also may lead to serious results under certain conditions. Both groups are crucial for safety installation. Read and understand them carefully.
- After installation, conduct the test operation of the device to check for any abnormalities. Describe how to operate the device to the customer following the installation instruction manual. Instruct the customer to keep this installation instruction for future reference.

⚠Warning

- This device should be installed by the dealer where you purchase the device or a licensed professional shop. If the device is incorrectly installed by the customer, it may result in electric shock or fire.
- Install the device carefully following the installation instruction. If the device is incorrectly installed, it may result in electric shock or fire.
- Use the accessory parts and specified parts for installation. If any parts that do not match the specifications are used, it may result in electric shock or fire.
- A person with the electrical service certification should conduct the service based on the “Technical standards for electrical facilities”, “Electrical Wiring Code”, and the installation instruction. If the work is done incorrectly, it may result in electric shock or fire.
- Wiring should be securely connected using the specified types of wire. No external force on the wire should be applied to any terminals. If a secure connection is not achieved, it may result in electric shock or fire.

⚠Caution

- Provide ground connection.
The ground line should never be connected to the gas supply piping, the water supply piping, the lightning conductor rod, nor the telephone ground. If the grounding is improper, it may result in electric shock.
- Do not install the device in the following locations.
 1. Where there is mist/spray of oil or steam such as kitchens.
 2. Where there is corrosive gases such as sulfuric acid gas.
 3. Where there is a device generating electromagnetic waves.
These may interfere with the control system resulting in the device becoming uncontrollable.
 4. Where flammable volatile materials such as paint thinner and gasoline may exist or where they are handled. This may cause a fire.

1 Application

Indoor-to-outdoor three core communication specification type 3 (since October 2007)

2 Accessories

			 M4 × 8 2 pieces
M4 × 8 2 pieces	To secure the print board and the metal box Made of nylon 4 pieces		

5 Connection outline

Note for setting the address

- Set the address between 00 and 47 for the previous Superlink connection and between 000 and 127 for the new Superlink connection. (*1)
- Do not set the address overlapping with those of the other devices in the network. (The default is 000)

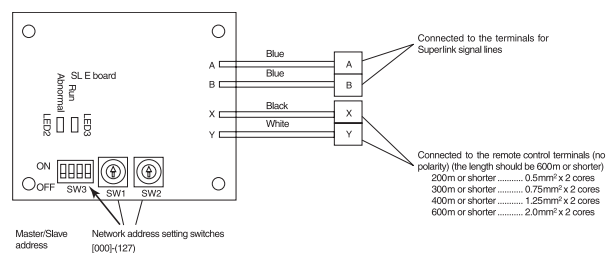

(*1) Whether the actual link is either the new Superlink or the previous Superlink depends on the models of the connected outdoor and indoor units. Consult the agent or the dealer.

3 Function

Allowing the central control SL1N-E, SL2NA-E, and SL4-AE/BE to control and monitor the commercial air-conditioner unit.

4 Control switching

Settings can be changed by the DIP switch SW3 on the SL E board as in the following.

Switch	Symbol	Switch	Remarks
SW3	1	ON	Master
		OFF (default)	Slave
	2	ON	Fixed previous protocol
		OFF (default)	Automatic adjustment of Superlink protocol
	3	ON	Indicates the forced operation stop when abnormality has occurred.
		OFF (default)	Indicates the status of running/stop as it is, when abnormality has occurred.
	4	ON	The hundredth address activated “1”
		OFF (default)	The hundredth address activated “0”

Signal line specification

Communication method	Previous Superlink	New Superlink
Line type	MVVS	MVVS
Line diameter	0.75 - 1.25mm ²	0.75/1.25mm ²
Signal line (total length)	up to 1000m	up to 1500/1000m (*2)
Signal line (maximum length)	up to 1000m	up to 1000m

(*2) Up to 1500m for 0.75mm², and up to 1000m for 1.25mm².

Do not use 2.0mm². It may cause an error.

(*3) Connect grounding on both ends of the shielding wire.

For the grounding method, refer to the section “6 Installation”.

- (1) Set the Superlink network address with SW1 (tens place), SW2 (ones place), and SW3 (hundreds place).
- (2) Set the SL E board SW3-1 to be ON (Master) when using this without any remote control (no wired remote controller nor wireless remote control).
- (3) Set up the plural master/slave device using the DIP switches on the indoor unit board.
- (4) Set up the remote control master/slave device using the slide switch on the remote control board.
- (5) Set up "0" to "F" using the address rotary switch on the indoor unit board when controlling the indoor unit with the multiple remote control.

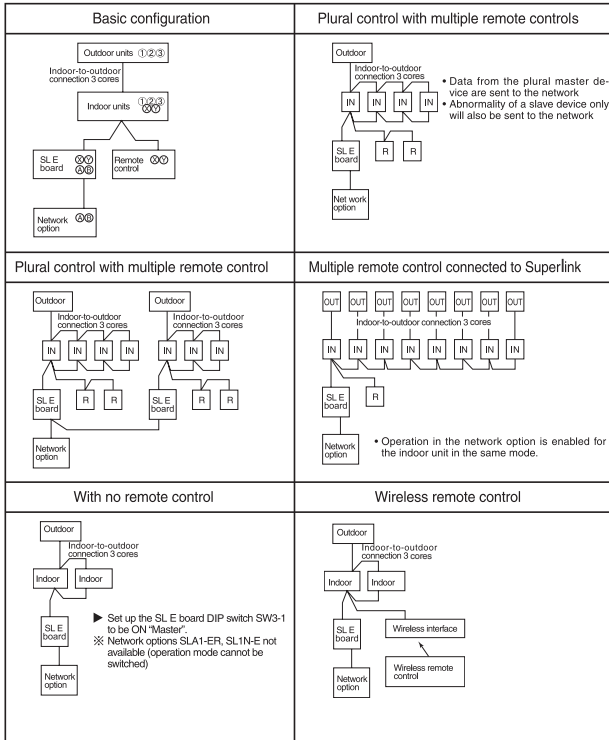

Connect grounding. Connect grounding for the power line to Ground ①, and grounding for the signal line to Ground ② or to the Ground on the indoor unit control box.

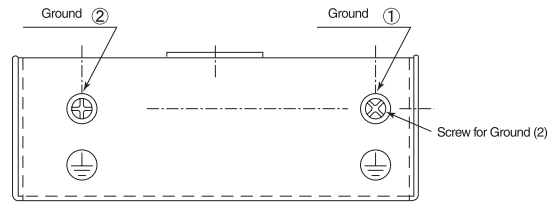

2. When connecting to the indoor unit control box (ceiling-concealed type and FDT type only):

- (1) Mount the SL E board in the control box using the locking supports.
- (2) Remove 6 bands from the box and put the wiring through the bands to be secured.

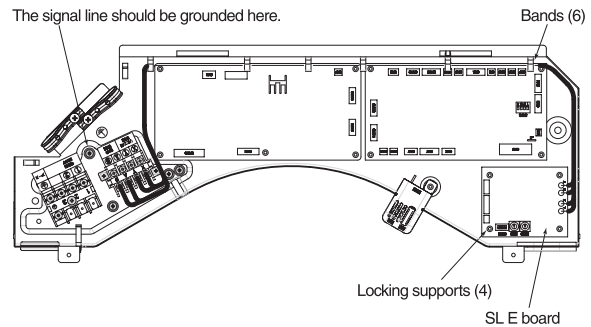

Electrical shock hazard! make sure to turn the power off for servicing. Be cautious so that no abnormal force should be applied to the wiring. Do not let the SL E board hung by the wiring. Do not damage the board with a screwdriver. The board is sensitive to static electricity. Release the static electricity of your body before servicing. (You can do this by touching the control board which is grounded).

Location of installation

Install the device at the location where there are no electromagnetic waves nor where there is water and dust. The specified temperature range of the device is 0 to 40°C. Install the device at the location where the ambient temperature stays within the range. If it exceeds the specification, make sure to provide solution such as installing a cooling fan. When used outside of the range, it may cause abnormal operation.

6 Installation

1. When using the metal box (mounted on the indoor unit / mounted on the back of the remote control):

- (1) Mount the SL E board in the metal box using the locking supports.
- (2) Wiring should go through the provided grommet since then through the wiring to the hole on the Metal box. Secure the grommet after inserting the grommet into the Metal box as shown in below figure, then tie the wiring at the outlet of the unit using a binding band.

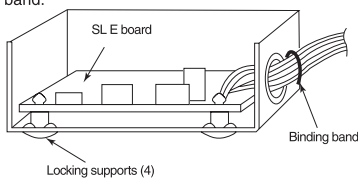

▲ When installed outside the indoor unit, put the metal cover on.

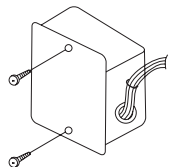

▲ When installed on the back of the remote control, mount it directly on the remote control bottom case.

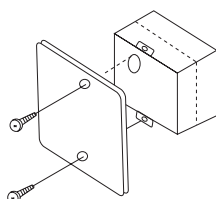

7 Indicator display

Check the LED 3 (green) and LED 2 (red) on the SL E board for flashing.

SL E board LEDs		Inspection mode	Display on the integrated network control device
Red	Green		
Off	Flashing	Normal communication	
Off	Off	<ul style="list-style-type: none"> Disconnection in the remote control communication line (X or Y) Short-circuit in the remote control communication line (between X and Y) Faulty indoor unit remote control power Faulty remote control communication circuit Faulty CPU on SL E board 	No corresponding unit number
One flash	Flashing	<ul style="list-style-type: none"> Disconnection in the Superlink signal line (A or B) Short-circuit in the Superlink signal line (between A and B) Faulty Superlink signal circuit 	
Two flashes	Flashing	<ul style="list-style-type: none"> Faulty address setting for the SL E board (Set up the address for previous SL E board : more than 48 new SL E board : more than 128) 	
Three flashes	Flashing	<ul style="list-style-type: none"> SL E board parent not set up when used without a remote control Faulty remote control communication circuit 	E1
Four flashes	Flashing	<ul style="list-style-type: none"> Address overlapping for the SL E board and the Superlink network connected indoor unit 	E2
Off	Flashing	<ul style="list-style-type: none"> Number of connected devices exceeds the specification for the multiple indoor unit control 	E10

8.7 Ceiling concealed type (SRR) option parts

(1) Bottom air inlet kit

This manual contains installation points for BOTTOM AIR INLET KIT manufactured by MHI.
 Carry out the work following the instructions below.
 Keep this manual properly with USER'S MANUAL provided with the indoor unit.

CAUTION

- After unpacking, carry out this work on the ground.
- Do not carry out the work during operation, or there is a danger of being entangled in the rotating parts and getting injured.
- Be sure to cut off the power and stop the unit before maintenance.

1) Applicable model of unit and type of BOTTOM AIR INLET KIT

BOTTOM AIR INLET KIT		UT-BAT1EF	UT-BAT2EF	UT-BAT3EF
Model	for FDUT	15,22,28,36	45,56	71
	for SRR	25,35	50,60	

2) Parts list of BOTTOM AIR INLET KIT

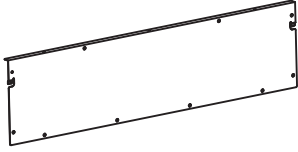
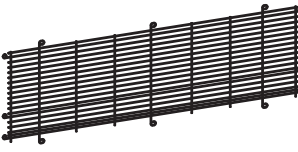
Rear panel	Fan guard	Parts set (Tapping screw)
 1 pc.	 1 pc.	4mm(diameter)×12mm(length) UT-BAT1EF 12 pcs. UT-BAT2EF 12 pcs. UT-BAT3EF 14 pcs.

3) Installation Points

(Figure shows the state that the unit is placed on a floor. Top and bottom are inverted after installing the unit.)

(i) Place the unit as shown below.

(ii) Remove the bottom plate and duct flange plate of rear from the unit. Keep the removed tapping screws to reuse later.

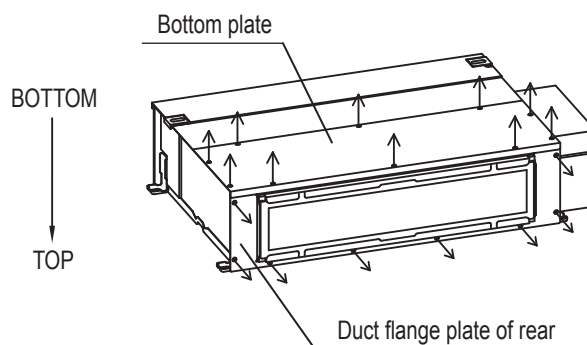

◆The number of tapping screws to be removed

	Model	Bottom	Rear
FDUT	15,22,28,36	10 pcs.	8 pcs.
	45,56	10 pcs.	9 pcs.
	71	12 pcs.	8 pcs.
SRR	25,35	10 pcs.	8 pcs.
	50,60	10 pcs.	9 pcs.

(iii) Install rear panel by using removed tapping screws in process(2). Install fan guard by using tapping screws in parts set.

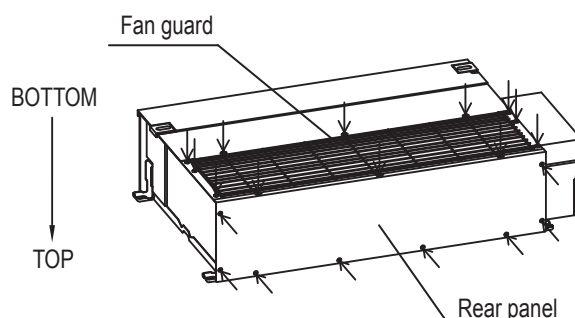

◆The number of tapping screws to be tightened

	Model	Fan guard	Rear panel
FDUT	15,22,28,36	12 pcs.	8 pcs.
	45,56	12 pcs.	9 pcs.
	71	14 pcs.	8 pcs.
SRR	25,35	12 pcs.	8 pcs.
	50,60	12 pcs.	9 pcs.

(2) Remote sensor kit (SC-THB-E3)

Sensor for return air temperature detection is located in the air inlet of the indoor unit.

Use the remote sensor kit SC-THB-E3, and install it on the suitable wall so the temperature of the room can be accurately detected.

This remote sensor kit is to be used as an alternative to the pre-installed sensor of the indoor unit.

1) Accessory parts

No.	Part name	Q'ty	No.	Part name	Q'ty
①	Sensor box	1	④	Band	1
②	Cable (8m)	1	⑤	Screw (4×16)	2
③	Tape (Double -stick)	1			

※Installation manual in the SC-THB-E3 is not it for SRR_ZM-S.

2) Selection of installation position

- The thermistor for detecting room temperature is located inside the remote sensor box.
- Do not install the remote sensor in places where.
 - Average room temperature can not be detected.
 - A heat source is located nearby.
 - The wall temperature is different from average room temperature.
 - Affected by the outdoor air when opening / closing the door, etc.
 - The discharge air from indoor unit blows directly.
 - Covered by curtains or other obstacles.
 - Exposed to the sun.
 - Exposed to water, humidity or dew.
- Mount the remote sensor vertically on the wall surface, etc.
- Run the sensor cable in a place where the power cable or electrical noise will not cause any abnormal operation.

3) Installation procedure

- (a) Insert the tip of slotted screwdriver to the gap between the cover and base of the sensor box (①), and twist it to disassemble.
- (b) Fix the base to the wall with screws (⑤).
- (c) Connect the cable (②) to the terminal block in the base. (No polarity)
- (d) Attach the cover to the base.

Remote sensor box

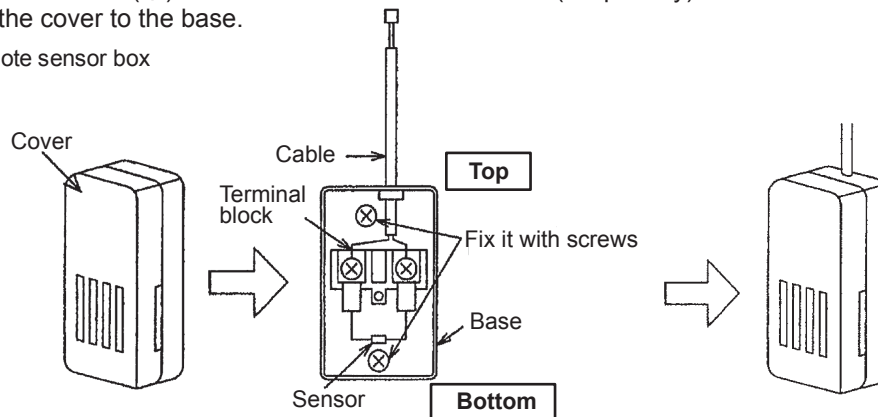

- (e) Remove the control lid of the indoor unit. Take off CnG connector from PCB of the indoor unit .

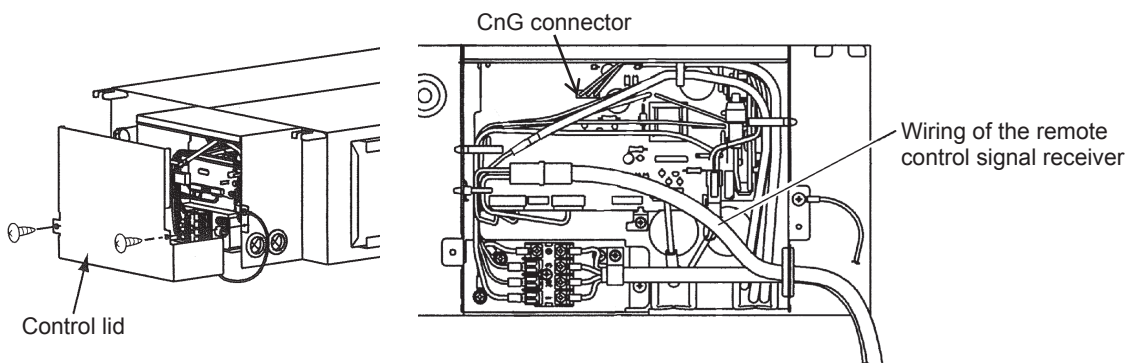

- (f) Cut wiring from 1 & 2 pins of CnG connector. (wiring length : about 100 mm from the connector)
 If the pre-installed return air temperature sensor ASSY is not removed, the end of the sensor wiring should prevent a short circuit by insulating tape etc.

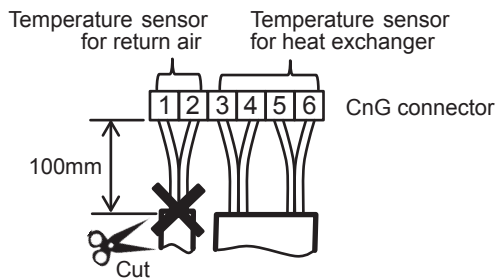

- (g) Insert the cable from remote sensor box to the control box of the indoor unit through the grommet of the remote control signal receiver side.
 (h) Adjust the length of the cable and cut it off. (Connector cable is not need.)
 (i) Connect the cable from remote sensor box and the cut wiring (procedure (f)) of CnG connector. (No polarity)

Be sure to connect the wirings by solder separately. Then, wirings should prevent a short circuit separately by insulating tapes etc. In case of faulty wiring connection, it can cause electrical shock and fire.

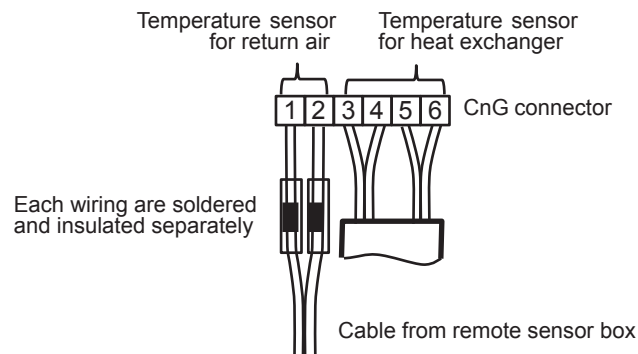

- (j) Put CnG connector back on the indoor unit PCB.
 (k) Attach the control lid of the indoor unit.

8.8 OA spacer (FDTC only)

This manual describes the installation methods for OA spacer (TC-OAS-E2) and the duct joint (TC-OAD-E).

Ⓞ This OA spacer is designed for assembling on the indoor unit (FDTC Series), not for be using independently.

PJZ012D125 

Application model	FDTC15-56KXZE1 FDTC25-60VH
-------------------	-------------------------------

Ⓞ Prepare the duct (size: ø75) and the booster fan at site.

Ⓞ For the installation of indoor unit, refer to the installation manual attached to the indoor unit.

SAFETY PRECAUTIONS

- Read the "SAFETY PRECAUTIONS" carefully first of all and then strictly follow it during the installation work in order to protect yourself.

WARNING

- **Installation should be performed by the specialist.**

If you install the unit by yourself, it may lead to serious trouble such as water leakage, electric shock, fire, and injury due to overturn of the unit. 

- **Install the system correctly according to these installation manuals.**

Improper installation may cause explosion, injury, water leakage, electric shock, and fire. 

- **Use the genuine accessories and the specified parts for installation.**

If parts unspecified by our company are used it could cause water leakage, electric shock, fire, and injury due to overturn of the unit. 

- **Turn off the power source during servicing or inspection work.**

If the power is supplied during servicing or inspection work, it could cause electric shock and injury by the operating fan. 

- **Shut off the power before electrical wiring work.**

It could cause electric shock, unit failure and improper running. 

CAUTION







- **Do not install and use the unit where corrosive gas (such as sulfuric acid gas etc.) or flammable gas (such as thinner, petroleum etc.) may be generated or accumulated, or volatile flammable substances are handled.**

It could cause the corrosion of heat exchanger, breakage of plastic parts etc. And inflammable gas could cause fire. 





① Before installation

- Confirm the following parts are included:

OA spacer (TC-OAS-E2)

Spacer	Bracket 1	Bracket 2	Bracket 3	Bracket 4	Bolt
					
1	2	2	2	2	8

Duct joint (TC-OAD-E)

Duct Joint	Screw	Insulation 1 (120 × 54)	Insulation 2 (40 × 60)
			
1	6	1	2

② Prior study before installation (Usage limitation)

(1) Temperature conditions for OA spacer

- Adjust the temperature conditions of mixed air with outdoor air and indoor air within the usage range of suction air temperature for the air-conditioner.
- The usage temperature conditions of intake outdoor air and indoor air around the ducts are shown in the following table.
- If the temperature conditions of intake outdoor air do not meet, process the outdoor air before intaking.

Operation mode	Usage temperature conditions	
	Intake outdoor air	Indoor air around the ducts
In heating	5°C DB or higher	18.5°C WB or lower and 60% RH or lower
In cooling	29°C DB or lower and 80% RH or lower	20°C DB or higher

(2) Intake outdoor air volume

- Intake outdoor air volume is 3.0 m³/min at the maximum (when two sets of duct joints are used). Up to two sets of duct joint can be installed on OA spacer.
- In case one set of duct joint is installed: 1.5 m³/min max.
- In case two sets of duct joint is installed: 3.0 m³/min max.

(3) Selection of booster fan

- Select the booster fan based on the duct resistance plus the pressure loss at the duct joint. (See the figure)

(4) Other conditions

- Determine the capacity of air conditioner based on the calculation of air-conditioning load including the heat load of intake outdoor air.
- Install the filter for the intake outdoor air and the reverse flow prevention dumper during the duct work at site.
- Insulate the duct and duct joint in order to prevent dewing.
- Interlock the operation of booster fan with ON/OFF operation of the indoor unit. (See Section 7.)

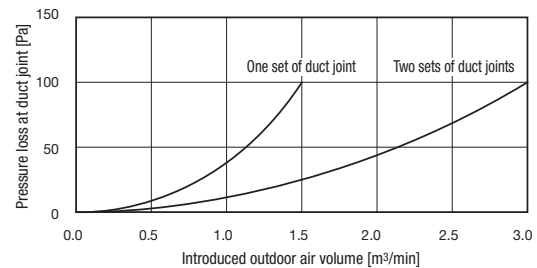
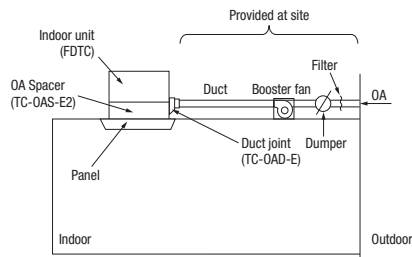
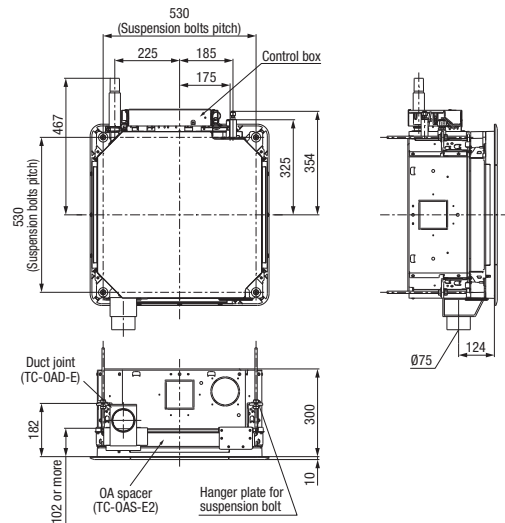

③ Installation of duct joint (TC-OAD-E) onto OA spacer

- There are two places where the duct joint can be installed.

When installing one duct joint

Install OA spacer at either one of two installation places on the duct joint.

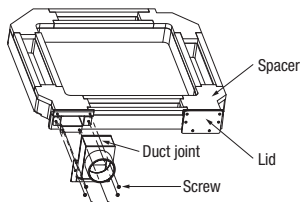

To install the duct joint, screw it in as shown at left.

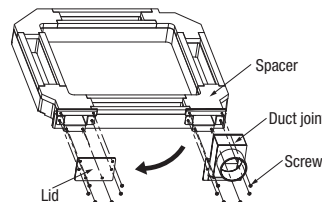

When installing the duct joint at the lid side, remove the lid and reinstall it at the other end before installing the duct joint.

When installing two duct joints

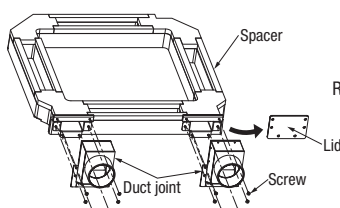

Remove the lid and then install two pieces of duct joint.

4 Installation of OA spacer on the indoor unit

OA spacer can be installed regardless whether the indoor unit has already been hanged or not.
(It is recommended to install before hanging the unit for convenience of installation.)

1-1. When installing OA spacer before hanging the indoor unit

- ① Placing OA spacer on the indoor unit, fix the brackets 1 and 2 (2 pieces each) with bolts.
Install OA spacer in the appropriate position that the duct joint side of OA spacer becomes opposite to the control box of indoor unit (FDTC).

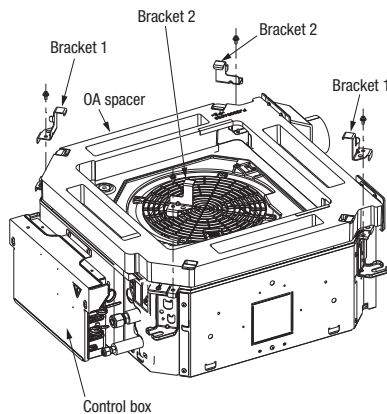

- ② Fix the brackets 3 and 4 (2 pieces each) with bolts.

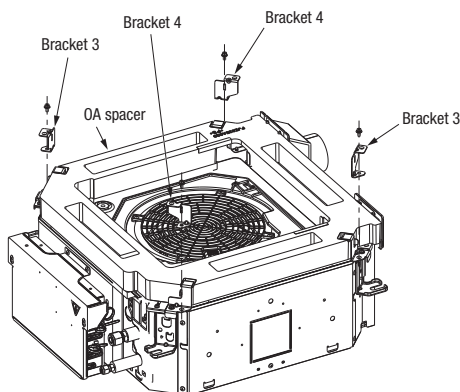

2. Applying insulation

Applying the insulation attached to duct joint set (TC-OAD-E)

- ① Applying the insulation 1 as shown in the figure.
- ② Applying the insulation 2 as shown in the figure.

* Be sure to cover the entire surface of sheet metal of the duct joint with the insulation.

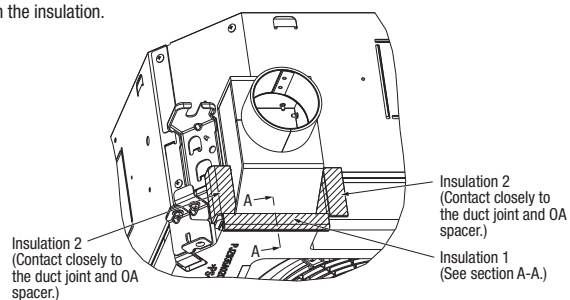
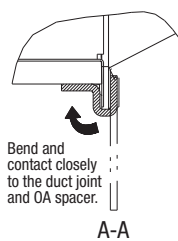

1-2. When installing OA spacer after hanging the indoor unit

- ① After hanging the indoor unit (*), fix the bracket 1 (2 pieces) temporarily with bolt by 2 turns as shown in the figure.
* For the height (position) of hanging the indoor unit, refer to Section 5.

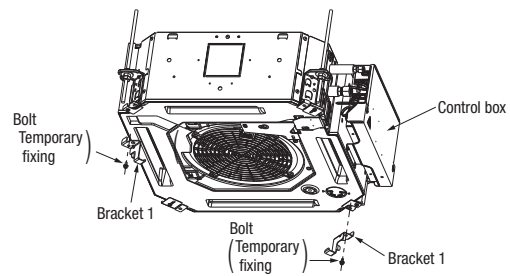

- ② Install OA spacer.
 - i. Install it in the way that the recess of OA spacer will fit on the bracket 1 fixed temporarily at the step ①.
 - ii. Tighten the bolt of bracket 1.
 - iii. Fix the bracket 2 with bolt. (Tighten up)

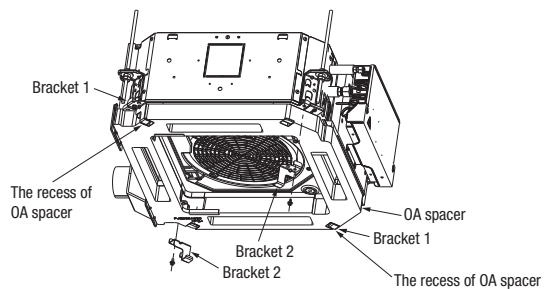

- ③ Fix the brackets 3 and 4 (2 pieces each) with bolts.

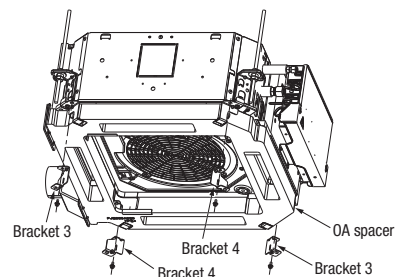

5 Installation of indoor unit

Work procedure

- This unit is designed for 2 × 2 grid ceiling.
If necessary, please detach the T bar temporarily before you install it.
If it is installed on a ceiling other than 2 × 2 grid ceiling, provide an inspection port on the control box side.
- Arrange the suspension bolt at the right position (530mm/530mm).
- Make sure to use four suspension bolts and fix them so as to be able to hold 500N load.
- Ensure that the lower end of the suspension bolt should be 102mm above the ceiling plane. Temporarily put the four lower nuts 182mm above the ceiling plane and the upper nuts on distant place from the lower nuts in order not to obstruct hanging the indoor unit or adjust the indoor unit position, and then hang the indoor unit.
- Adjust the indoor unit position after hanging it by inserting the level gauge (Packed together with the indoor unit.) attached on the package into the air supply port and checking if the gap between the ceiling plane and the indoor unit is appropriate. (*) In order to adjust the indoor unit position, adjust the lower nuts while the upper nuts are put on distant place. Confirm there is no backlash between the hanger plate for suspension bolt and the lower nut and washer.
* Use the level gauge only when OA spacer has been installed before hanging (4) 1-1 only).

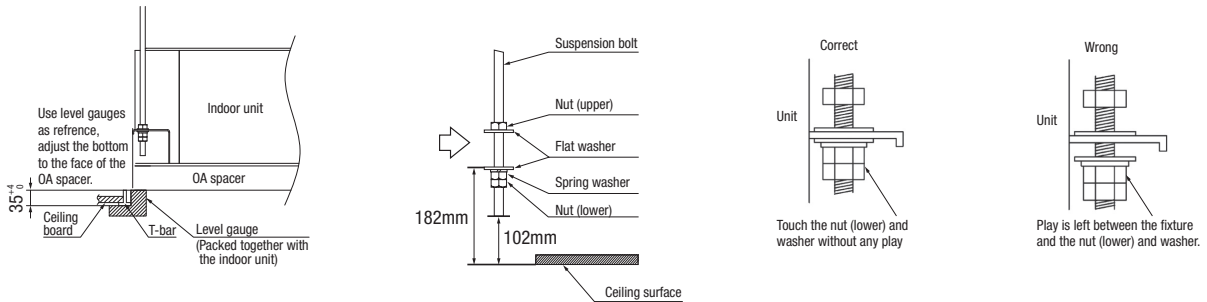

6 Installation of panel

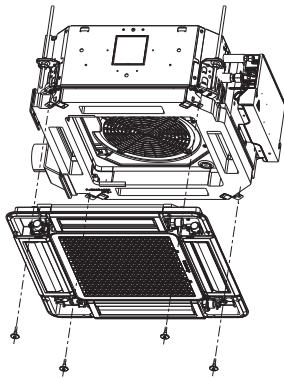

Tighten the panels to the brackets 3 and 4 with bolts.
For further details, refer to the installation manual of panel.
(Caution) Connect the connector of lower motor within the control box.

7 Interlocking with the indoor unit fan

- Connect the Single split series and the VRF series to CNT on the indoor PCB and to CND on the indoor PCB respectively. If a ventilation device is connected, be geared with the motion of indoor device (ON: DC12V output, OFF: 0V output), the ventilation device is operated/stopped.
- Set it at "VENT LINK" by selecting "No. 11 VENT LINK SET" from the functional setting by remote control. For details, refer to the "ELECTRIC WIRING WORK INSTRUCTION" of indoor unit.

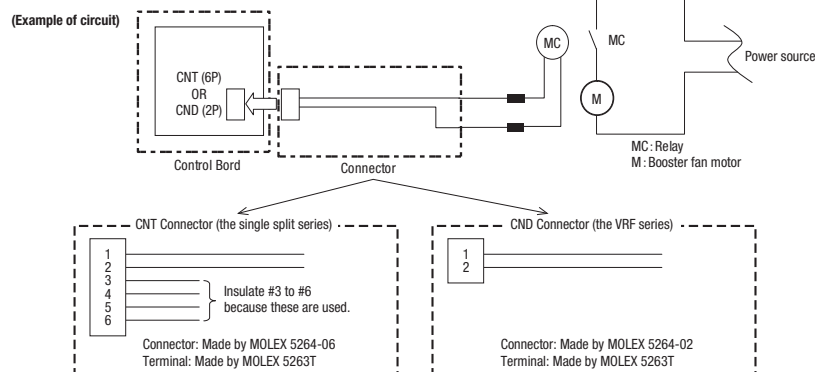

(Caution) Although the indoor unit fan stops during the defrosting or oil return operation, the booster fan is operating.
Use a total heat exchanger, if necessary.





8.9 Duct joint (FDTC only)

PJZ012D073 

● This product is used by assembling on the spacer (TC-OAS-E2)

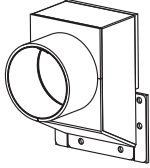
1. Before installation

- Confirm the following parts are included:

Duct joint	Screw	Insulation 1 (120 × 54)	Insulation 2 (40 × 60)
			
1	6	1	2

2. Regarding the use of this product

- Fix the product on the spacer (TC-OAS-E2) as shown below.
- For the installation method, refer to the installation manual of the spacer.

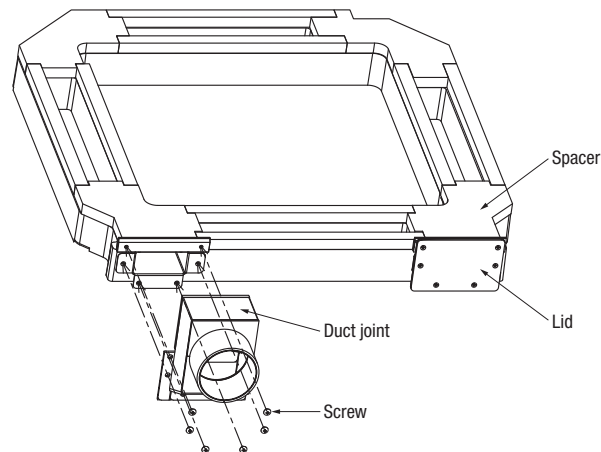

8.10 Filter kit (FDUM only)



This manual contains installation points and operating instructions for the filter kit manufactured by MHI. Carry out the work following the instructions below.

This manual also contains information on the usage after installation, so keep this manual properly with USER'S MANUAL provided with the indoor unit.

CAUTION

- After unpacking, carry out this work on the ground.
- Do not carry out the work during operation, or there is a danger of being entangled in the rotating parts and getting injured.
- Clean the air filter regularly.
- Be sure to entrust qualified serviceman to performance on the air filter.
- Be sure to cut off the power and stop the unit before performing maintenance.

1. Table of filter kit parts No. and corresponding object models

	Small model	Medium model	Large model
Single type	40, 50	60, 71	100 - 140
Multi type	22 - 56	71, 90	112 - 160
Filter Kit	UM-FL1EF	UM-FL2EF	UM-FL3EF

2. Parts list of filter kit

Filter	Rail	Insulation
 1 pc.	 2 pcs.	 2 pcs.
Bracket	Parts set(screw)	
 1 pc.	 small and medium model : 5 pcs.	 large model : 7 pcs.
	1 pc.	

3. Installation Points

(1) Stick the insulation on both inner sides of the duct, leaving no space up and down.

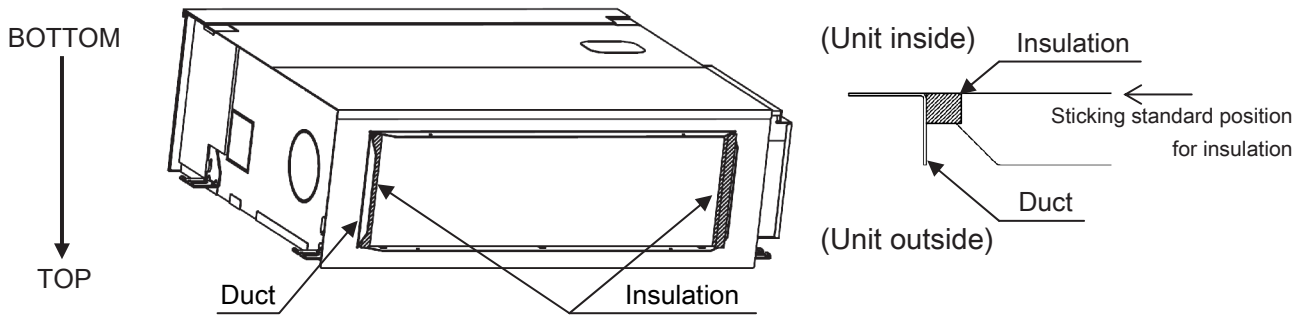

(*) After unpacking, bottom side of the unit is located at the upper side.

(2) Install the rail on both inner sides of the duct with the screw.

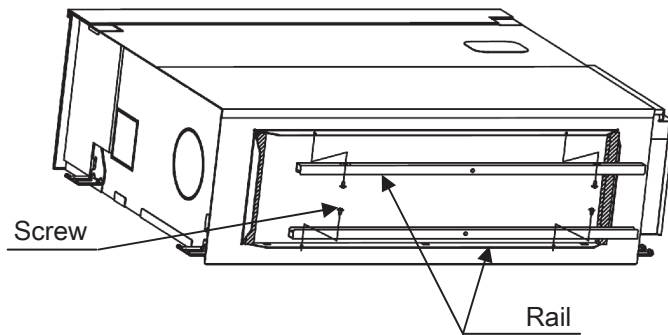

(3) Install the air filter on the rails.

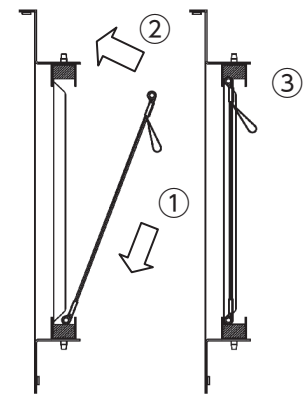
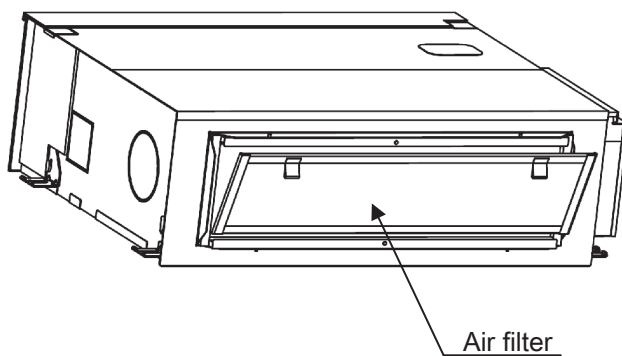

Installation procedure

(4) Install the bracket on the rail with the screw.

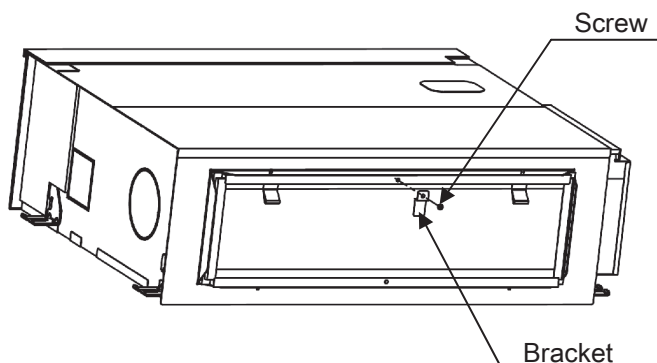

(**) When the unit is installed, bottom side of the unit is located at the lower side.

9. TECHNICAL INFORMATION

Model SCM100ZS-W

Information to identify the model(s) to which the information relates to:		If function includes heating: Indicate the heating season the information relates to. Indicated values should relate to one heating season at a time. Include at least the heating season 'Average'.	
Indoor unit model name	SRK50ZSX-W X 2		
Outdoor unit model name	SCM100ZS-W		
Function(indicate if present)		Average(mandatory)	
cooling	Yes	Warmer(if designated)	Yes
heating	Yes	Colder(if designated)	Yes
Item	symbol	value	unit
Design load			
cooling	Pdesignc	10	kW
heating / Average	Pdesignh	6.8	kW
heating / Warmer	Pdesignh	8.6	kW
heating / Colder	Pdesignh	-	kW
Declared capacity at outdoor temperature Tdesignh			
heating / Average (-10°C)	Pdh	6.8	kW
heating / Warmer (2°C)	Pdh	8.6	kW
heating / Colder (-22°C)	Pdh	-	kW
Declared capacity for cooling, at indoor temperature 27(19)°C and outdoor temperature Tj			
Tj=35°C	Pdc	10	kW
Tj=30°C	Pdc	7.3	kW
Tj=25°C	Pdc	4.7	kW
Tj=20°C	Pdc	3.2	kW
Declared capacity for heating / Average season, at indoor temperature 20°C and outdoor temperature Tj			
Tj=-7°C	Pdh	6	kW
Tj=2°C	Pdh	3.7	kW
Tj=7°C	Pdh	2.3	kW
Tj=12°C	Pdh	2.3	kW
Tj=bivalent temperature	Pdh	6.8	kW
Tj=operating limit	Pdh	6.8	kW
Declared capacity for heating / Warmer season, at indoor temperature 20°C and outdoor temperature Tj			
Tj=2°C	Pdh	8.6	kW
Tj=7°C	Pdh	5.2	kW
Tj=12°C	Pdh	2.3	kW
Tj=bivalent temperature	Pdh	8.6	kW
Tj=operating limit	Pdh	8.6	kW
Declared capacity for heating / Colder season, at indoor temperature 20°C and outdoor temperature Tj			
Tj=-7°C	Pdh	-	kW
Tj=2°C	Pdh	-	kW
Tj=7°C	Pdh	-	kW
Tj=12°C	Pdh	-	kW
Tj=bivalent temperature	Pdh	-	kW
Tj=operating limit	Pdh	-	kW
Tj=-15°C	Pdh	-	kW
Bivalent temperature			
heating / Average	Tbiv	-10	°C
heating / Warmer	Tbiv	2	°C
heating / Colder	Tbiv	-	°C
Operating limit temperature			
heating / Average	Tol	-10	°C
heating / Warmer	Tol	2	°C
heating / Colder	Tol	-	°C
Cycling interval capacity		Cycling interval efficiency	
for cooling	Pcycc	-	kW
for heating	Pcyh	-	kW
Degradation coefficient		Degradation coefficient	
cooling	Cdc	0.25	-
heating	Cdh	0.25	-
Electric power input in power modes other than 'active mode'		Annual electricity consumption	
off mode	Poff	8	W
standby mode	Psb	8	W
thermostat-off mode	Pto(cooling)	25	W
	Pto(heating)	30	W
crankcase heater mode	Pck	0	W
Capacity control(indicate one of three options)		Other items	
fixed	No	Sound power level(indoor)	Lwa 59 dB(A)
staged	No	Sound power level(outdoor)	Lwa 69 dB(A)
variable	Yes	Global warming potential	GWP 675 kgCO2eq
		Rated air flow(indoor)	- 858 m³/h
		Rated air flow(outdoor)	- 4500 m³/h
Contact details for obtaining more information	Name and address of the manufacturer or of its authorised representative. MHIAE SERVICES B.V. Herikerbergweg 238, Luna Arena, 1101 CM Amsterdam, Netherlands		

RWA000Z342

Information to identify the model(s) to which the information relates to:				If function includes heating: Indicate the heating season the information relates to. Indicated values should relate to one heating season at a time. Include at least the heating season 'Average'.			
Indoor unit model name		SRK25ZS-W X 2+SRK50ZS-W		Average(mandatory)		Yes	
Outdoor unit model name		SCM100ZS-W		Warmer(if designated)		Yes	
Function(indicate if present)				Colder(if designated)			
cooling		Yes					
heating		Yes					
Item				Item			
symbol		value		symbol		value	
unit		unit		class		class	
Design load				Seasonal efficiency and energy efficiency class			
cooling		Pdesignc		cooling		SEER	
		10				7.30	
heating / Average		Pdesignh		heating / Average		SCOP/A	
		6.8				4.20	
heating / Warmer		Pdesignh		heating / Warmer		SCOP/W	
		8.6				5.40	
heating / Colder		Pdesignh		heating / Colder		SCOP/C	
		-				-	
Declared capacity at outdoor temperature Tdesignh				Back up heating capacity at outdoor temperature Tdesignh			
heating / Average (-10°C)		Pdh		heating / Average (-10°C)		elbu	
		6.8				-	
heating / Warmer (2°C)		Pdh		heating / Warmer (2°C)		elbu	
		8.6				-	
heating / Colder (-22°C)		Pdh		heating / Colder (-22°C)		elbu	
		-				-	
Declared capacity for cooling, at indoor temperature 27(19)°C and outdoor temperature Tj				Declared energy efficiency ratio, at indoor temperature 27(19)°C and outdoor temperature Tj			
Tj=35°C		Pdc		Tj=35°C		EERd	
		10				3.1	
Tj=30°C		Pdc		Tj=30°C		EERd	
		7.3				5.4	
Tj=25°C		Pdc		Tj=25°C		EERd	
		4.7				9.6	
Tj=20°C		Pdc		Tj=20°C		EERd	
		3				14.1	
Declared capacity for heating / Average season, at indoor temperature 20°C and outdoor temperature Tj				Declared coefficient of performance / Average season, at indoor temperature 20°C and outdoor temperature Tj			
Tj=-7°C		Pdh		Tj=-7°C		COPd	
		6				3.1	
Tj=2°C		Pdh		Tj=2°C		COPd	
		3.7				4.1	
Tj=7°C		Pdh		Tj=7°C		COPd	
		2.3				5.3	
Tj=12°C		Pdh		Tj=12°C		COPd	
		2.2				5.6	
Tj=bivalent temperature		Pdh		Tj=bivalent temperature		COPd	
		6.8				2.4	
Tj=operating limit		Pdh		Tj=operating limit		COPd	
		6.8				2.4	
Declared capacity for heating / Warmer season, at indoor temperature 20°C and outdoor temperature Tj				Declared coefficient of performance / Warmer season, at indoor temperature 20°C and outdoor temperature Tj			
Tj=2°C		Pdh		Tj=2°C		COPd	
		8.6				3.1	
Tj=7°C		Pdh		Tj=7°C		COPd	
		5.3				5.47	
Tj=12°C		Pdh		Tj=12°C		COPd	
		2.3				5.9	
Tj=bivalent temperature		Pdh		Tj=bivalent temperature		COPd	
		8.6				3.1	
Tj=operating limit		Pdh		Tj=operating limit		COPd	
		8.6				3.1	
Declared capacity for heating / Colder season, at indoor temperature 20°C and outdoor temperature Tj				Declared coefficient of performance / Colder season, at indoor temperature 20°C and outdoor temperature Tj			
Tj=-7°C		Pdh		Tj=-7°C		COPd	
		-				-	
Tj=2°C		Pdh		Tj=2°C		COPd	
		-				-	
Tj=7°C		Pdh		Tj=7°C		COPd	
		-				-	
Tj=12°C		Pdh		Tj=12°C		COPd	
		-				-	
Tj=bivalent temperature		Pdh		Tj=bivalent temperature		COPd	
		-				-	
Tj=operating limit		Pdh		Tj=operating limit		COPd	
		-				-	
Tj=-15°C		Pdh		Tj=-15°C		COPd	
		-				-	
Bivalent temperature				Operating limit temperature			
heating / Average		Tbiv		heating / Average		Tol	
		-10				-10	
heating / Warmer		Tbiv		heating / Warmer		Tol	
		2				2	
heating / Colder		Tbiv		heating / Colder		Tol	
		-				-	
Cycling interval capacity				Cycling interval efficiency			
for cooling		Pcycc		for cooling		EERcyc	
		-				-	
for heating		Pcyh		for heating		COPcyc	
		-				-	
Degradation coefficient				Degradation coefficient			
cooling		Cdc		heating		Cdh	
		0.25				0.25	
Electric power input in power modes other than 'active mode'				Annual electricity consumption			
off mode		Poff		cooling		Qce	
		10				480	
standby mode		Psb		heating / Average		Qhe	
		10				2266	
thermostat-off mode		Pto(cooling)		heating / Warmer		Qhe	
		27				2231	
		Pto(heating)		heating / colder		Qhe	
		33				-	
crankcase heater mode		Pck				-	
		0				-	
Capacity control(indicate one of three options)				Other items			
fixed				Sound power level(indoor)		Lwa	
		No				59	
staged				Sound power level(outdoor)		Lwa	
		No				69	
variable				Global warming potential		GWP	
		Yes				675	
				Rated air flow(indoor)		-	
						726	
				Rated air flow(outdoor)		-	
						4500	
Contact details for obtaining more information		Name and address of the manufacturer or of its authorised representative.					
		MHIAE SERVICES B.V. Herikerbergweg 238, Luna ArenA, 1101 CM Amsterdam, Netherlands					

Information to identify the model(s) to which the information relates to:				If function includes heating: Indicate the heating season the information relates to. Indicated values should relate to one heating season at a time. Include at least the heating season 'Average'.			
Indoor unit model name		SRK25ZS-W × 4		Average(mandatory)		Yes	
Outdoor unit model name		SCM100ZS-W		Warmer(if designated)		Yes	
Function(indicate if present)				Colder(if designated)			
cooling		Yes		Colder(if designated)		Yes	
heating		Yes					
Item				Item			
symbol		value		symbol		value	
unit		unit		symbol		class	
Design load				Seasonal efficiency and energy efficiency class			
cooling		Pdesignc		cooling		SEER	
		10				7.90	
heating / Average		Pdesignh		heating / Average		SCOP/A	
		6.8				4.40	
heating / Warmer		Pdesignh		heating / Warmer		SCOP/W	
		8.6				5.70	
heating / Colder		Pdesignh		heating / Colder		SCOP/C	
		-				-	
Declared capacity at outdoor temperature Tdesignh				Back up heating capacity at outdoor temperature Tdesignh			
heating / Average (-10°C)		Pdh		heating / Average (-10°C)		elbu	
		6.8				-	
heating / Warmer (2°C)		Pdh		heating / Warmer (2°C)		elbu	
		8.6				-	
heating / Colder (-22°C)		Pdh		heating / Colder (-22°C)		elbu	
		-				-	
Declared capacity for cooling, at indoor temperature 27(19)°C and outdoor temperature Tj				Declared energy efficiency ratio, at indoor temperature 27(19)°C and outdoor temperature Tj			
Tj=35°C		Pdc		Tj=35°C		EERd	
		10				3.4	
Tj=30°C		Pdc		Tj=30°C		EERd	
		7.3				5.8	
Tj=25°C		Pdc		Tj=25°C		EERd	
		4.6				10.5	
Tj=20°C		Pdc		Tj=20°C		EERd	
		2.6				15.4	
Declared capacity for heating / Average season, at indoor temperature 20°C and outdoor temperature Tj				Declared coefficient of performance / Average season, at indoor temperature 20°C and outdoor temperature Tj			
Tj=-7°C		Pdh		Tj=-7°C		COPd	
		6				3.1	
Tj=2°C		Pdh		Tj=2°C		COPd	
		3.7				4.38	
Tj=7°C		Pdh		Tj=7°C		COPd	
		2.3				5.5	
Tj=12°C		Pdh		Tj=12°C		COPd	
		2				5.8	
Tj=bivalent temperature		Pdh		Tj=bivalent temperature		COPd	
		6.8				2.5	
Tj=operating limit		Pdh		Tj=operating limit		COPd	
		6.8				2.5	
Declared capacity for heating / Warmer season, at indoor temperature 20°C and outdoor temperature Tj				Declared coefficient of performance / Warmer season, at indoor temperature 20°C and outdoor temperature Tj			
Tj=2°C		Pdh		Tj=2°C		COPd	
		8.6				3.2	
Tj=7°C		Pdh		Tj=7°C		COPd	
		5.3				5.65	
Tj=12°C		Pdh		Tj=12°C		COPd	
		2.4				6.4	
Tj=bivalent temperature		Pdh		Tj=bivalent temperature		COPd	
		8.6				3.2	
Tj=operating limit		Pdh		Tj=operating limit		COPd	
		8.6				3.2	
Declared capacity for heating / Colder season, at indoor temperature 20°C and outdoor temperature Tj				Declared coefficient of performance / Colder season, at indoor temperature 20°C and outdoor temperature Tj			
Tj=-7°C		Pdh		Tj=-7°C		COPd	
		-				-	
Tj=2°C		Pdh		Tj=2°C		COPd	
		-				-	
Tj=7°C		Pdh		Tj=7°C		COPd	
		-				-	
Tj=12°C		Pdh		Tj=12°C		COPd	
		-				-	
Tj=bivalent temperature		Pdh		Tj=bivalent temperature		COPd	
		-				-	
Tj=operating limit		Pdh		Tj=operating limit		COPd	
		-				-	
Tj=-15°C		Pdh		Tj=-15°C		COPd	
		-				-	
Bivalent temperature				Operating limit temperature			
heating / Average		Tbiv		heating / Average		Tol	
		-10				-10	
heating / Warmer		Tbiv		heating / Warmer		Tol	
		2				2	
heating / Colder		Tbiv		heating / Colder		Tol	
		-				-	
Cycling interval capacity				Cycling interval efficiency			
for cooling		Pcyc		for cooling		EERcyc	
		-				-	
for heating		Pcyc		for heating		COPcyc	
		-				-	
Degradation coefficient				Degradation coefficient			
cooling		Cdc		heating		Cdh	
		0.25				0.25	
Electric power input in power modes other than 'active mode'				Annual electricity consumption			
off mode		Poff		cooling		Qce	
		11				444	
standby mode		Psb		heating / Average		Qhe	
		11				2165	
thermostat-off mode		Pto(cooling)		heating / Warmer		Qhe	
		28				2058	
		Pto(heating)		heating / colder		Qhe	
		36				-	
crankcase heater mode		Pck				-	
		0				-	
Capacity control(indicate one of three options)				Other items			
fixed		No		Sound power level(indoor)		Lwa	
						50	
staged		No		Sound power level(outdoor)		Lwa	
						69	
variable		Yes		Global warming potential		GWP	
						675	
				Rated air flow(indoor)		-	
						594	
				Rated air flow(outdoor)		-	
						4500	
Contact details for obtaining more information		Name and address of the manufacturer or of its authorised representative.					
		MHIAE SERVICES B.V. Herikerbergweg 238, Luna ArenA, 1101 CM Amsterdam, Netherlands					

Information to identify the model(s) to which the information relates to:				If function includes heating: Indicate the heating season the information relates to. Indicated values should relate to one heating season at a time. Include at least the heating season 'Average'.					
Indoor unit model name		SRK20ZS-W X 5		Average(mandatory)		Yes			
Outdoor unit model name		SCM100ZS-W		Warmer(if designated)		Yes			
Function(indicate if present)				Colder(if designated)				Yes	
cooling		Yes							
heating		Yes							
Item		symbol value unit		Item		symbol value class			
Design load				Seasonal efficiency and energy efficiency class					
cooling		Pdesignc 10 kW		cooling		SEER 8.60 A+++			
heating / Average		Pdesignh 6.8 kW		heating / Average		SCOP/A 4.50 A+			
heating / Warmer		Pdesignh 8.6 kW		heating / Warmer		SCOP/W 6.10 A+++			
heating / Colder		Pdesignh - kW		heating / Colder		SCOP/C - -			
Declared capacity at outdoor temperature Tdesignh				Back up heating capacity at outdoor temperature Tdesignh					
heating / Average (-10°C)		Pdh 6.8 kW		heating / Average (-10°C)		elbu 0 kW			
heating / Warmer (2°C)		Pdh 8.6 kW		heating / Warmer (2°C)		elbu 0 kW			
heating / Colder (-22°C)		Pdh - kW		heating / Colder (-22°C)		elbu - kW			
Declared capacity for cooling, at indoor temperature 27(19)°C and outdoor temperature Tj				Declared energy efficiency ratio, at indoor temperature 27(19)°C and outdoor temperature Tj					
Tj=35°C		Pdc 10 kW		Tj=35°C		EERd 3.7 -			
Tj=30°C		Pdc 7.3 kW		Tj=30°C		EERd 6.45 -			
Tj=25°C		Pdc 4.6 kW		Tj=25°C		EERd 11.5 -			
Tj=20°C		Pdc 2.3 kW		Tj=20°C		EERd 16.4 -			
Declared capacity for heating / Average season, at indoor temperature 20°C and outdoor temperature Tj				Declared coefficient of performance / Average season, at indoor temperature 20°C and outdoor temperature Tj					
Tj=-7°C		Pdh 6 kW		Tj=-7°C		COPd 3.1 -			
Tj=2°C		Pdh 3.7 kW		Tj=2°C		COPd 4.5 -			
Tj=7°C		Pdh 2.3 kW		Tj=7°C		COPd 5.6 -			
Tj=12°C		Pdh 1.9 kW		Tj=12°C		COPd 6.2 -			
Tj=bivalent temperature		Pdh 6.8 kW		Tj=bivalent temperature		COPd 2.5 -			
Tj=operating limit		Pdh 6.8 kW		Tj=operating limit		COPd 2.5 -			
Declared capacity for heating / Warmer season, at indoor temperature 20°C and outdoor temperature Tj				Declared coefficient of performance / Warmer season, at indoor temperature 20°C and outdoor temperature Tj					
Tj=2°C		Pdh 8.6 kW		Tj=2°C		COPd 3.4 -			
Tj=7°C		Pdh 5.4 kW		Tj=7°C		COPd 5.9 -			
Tj=12°C		Pdh 2.4 kW		Tj=12°C		COPd 7.05 -			
Tj=bivalent temperature		Pdh 8.6 kW		Tj=bivalent temperature		COPd 3.4 -			
Tj=operating limit		Pdh 8.6 kW		Tj=operating limit		COPd 3.4 -			
Declared capacity for heating / Colder season, at indoor temperature 20°C and outdoor temperature Tj				Declared coefficient of performance / Colder season, at indoor temperature 20°C and outdoor temperature Tj					
Tj=-7°C		Pdh - kW		Tj=-7°C		COPd - -			
Tj=2°C		Pdh - kW		Tj=2°C		COPd - -			
Tj=7°C		Pdh - kW		Tj=7°C		COPd - -			
Tj=12°C		Pdh - kW		Tj=12°C		COPd - -			
Tj=bivalent temperature		Pdh - kW		Tj=bivalent temperature		COPd - -			
Tj=operating limit		Pdh - kW		Tj=operating limit		COPd - -			
Tj=-15°C		Pdh - kW		Tj=-15°C		COPd - -			
Bivalent temperature				Operating limit temperature					
heating / Average		Tbiv -10 °C		heating / Average		Tol -10 °C			
heating / Warmer		Tbiv 2 °C		heating / Warmer		Tol 2 °C			
heating / Colder		Tbiv - °C		heating / Colder		Tol - °C			
Cycling interval capacity				Cycling interval efficiency					
for cooling		Pcycc - kW		for cooling		EERcyc - -			
for heating		Pcych - kW		for heating		COPcyc - -			
Degradation coefficient cooling				Degradation coefficient heating					
cooling		Cdc 0.25 -		heating		Cdh 0.25 -			
Electric power input in power modes other than 'active mode'				Annual electricity consumption					
off mode		Poff 12 W		cooling		Qce 407 kWh/a			
standby mode		Psb 12 W		heating / Average		Qhe 2116 kWh/a			
thermostat-off mode		Pto(cooling) 30 W		heating / Warmer		Qhe 1974 kWh/a			
crankcase heater mode		Pto(heating) 40 W		heating / colder		Qhe - kWh/a			
Pck 0 W									
Capacity control(indicate one of three options)				Other items					
fixed		No		Sound power level(indoor)		Lwa 48 dB(A)			
staged		No		Sound power level(outdoor)		Lwa 67 dB(A)			
variable		Yes		Global warming potential		GWP 675 kgCO2eq.			
				Rated air flow(indoor)		- 558 m³/h			
				Rated air flow(outdoor)		- 4500 m³/h			
Contact details for obtaining more information				Name and address of the manufacturer or of its authorised representative.					
				MHIAE SERVICES B.V. Herikerbergweg 238, Luna Arena, 1101 CM Amsterdam, Netherlands					

INVERTER MULTI-SPLIT SYSTEM RESIDENTIAL AIR-CONDITIONERS



MITSUBISHI HEAVY INDUSTRIES THERMAL SYSTEMS, LTD.

2-3, Marunouchi 3-chome, Chiyoda-ku, Tokyo, 100-8332, Japan
<http://www.mhi-mth.co.jp/en/>

Because of our policy of continuous improvement, we reserve the right to make changes in all specifications without notice.

© Copyright MITSUBISHI HEAVY INDUSTRIES THERMAL SYSTEMS, LTD.