



SERVICE MANUAL

HYPER INVERTER PACKAGED AIR-CONDITIONERS (Split system, air to air heat pump type)

CEILING CASSETTE- 4 WAY TYPE

FDT40ZSXVH
50ZSXVH
60ZSXVH

CONTENTS

1. OUTLINE OF OPERATION CONTROL BY MICROCOMPUTER	3
1.1 Remote control (Option parts)	3
1.2 Operation control function by the wired remote control	6
1.3 Operation control function by the indoor control	9
(1) Auto operation	9
(2) Operations of functional items during cooling/heating	10
(3) Dehumidifying (DRY) operation	10
(4) Timer operation	11
(5) Hot start (Cold draft prevention at heating)	12
(6) Hot keep	12
(7) Auto swing control	13
(8) Thermostat operation	14
(9) Filter sign	15
(10) Compressor inching prevention control	15
(11) Drain pump control	16
(12) Drain pump motor (DM) control	16
(13) Operation check/drain pump test run operation mode	16
(14) Cooling, dehumidifying frost protection	17
(15) Heating overload protection	17
(16) Anomalous fan motor	17
(17) Plural unit control - Control of 16 units group by one remote control	18
(18) High ceiling control	18
(19) Abnormal temperature sensor (return air/indoor heat exchanger) broken wire/short-circuit detection ...	19
(20) External input/output control (CnT or CnTA)	19
(21) Operation permission/prohibition	21
(22) Temporary stop input	23
(23) Selection of cooling/heating external input function	23
(24) Fan control at heating startup	24
(25) Room temperature detection temperature compensation during heating	24
(26) Return air temperature compensation	24
(27) High power operation (RC-EX3A only)	24
(28) Energy-saving operation (RC-EX3A only)	24
(29) Warm-up control (RC-EX3A only)	24
(30) Home leave mode (RC-EX3A only)	24
(31) Auto temperature setting (RC-EX3A only)	24
(32) Fan circulator operation (RC-EX3A only)	25
(33) The operation judgment is executed every 5 minutes (RC-EX3A only) ...	25
(34) Auto fan speed control (RC-EX3A only)	25
(35) Indoor unit overload alarm (RC-EX3A only)	25

(36) Peak-cut time (RC-EX3A only)	25
(37) Motion sensor control (RC-EX3A only)	26
1.4 Operation control function by the outdoor control	27
(1) Defrost operation	27
(2) Cooling overload protective control	27
(3) Cooling high pressure control	28
(4) Cooling low outdoor air temperature protective control	28
(5) Heating high pressure control	29
(6) Heating overload protective control	29
(7) Heating low outdoor temperature protective control	30
(8) Compressor overheat protection	30
(9) Current safe	31
(10) Current cut	31
(11) Outdoor unit failure	31
(12) Serial signal transmission error protection	31
(13) Rotor lock	31
(14) Outdoor fan motor protection	31
(15) Outdoor fan control at low outdoor temperature	31
(16) Refrigeration cycle system protection	32
2. MAINTENANCE DATA	33
2.1 Diagnosing of microcomputer circuit	33
(1) Selfdiagnosis function	33
(2) Troubleshooting procedure	36
(3) Troubleshooting at the indoor unit	36
(4) Troubleshooting at the outdoor unit	39
(5) Check of anomalous operation data with the remote control	40
(6) Inverter checker for diagnosis of inverter output	42
(7) Outdoor unit control failure diagnosis circuit diagram	43
2.2 Troubleshooting flow	45
(1) List of troubles	45
(2) Troubleshooting	46
3. ELECTRICAL WIRING	89
4. PIPING SYSTEM	91

1. OUTLINE OF OPERATION CONTROL BY MICROCOMPUTER

1.1 Remote control (Option parts)

(1) Wired remote control

Model RC-EX3A

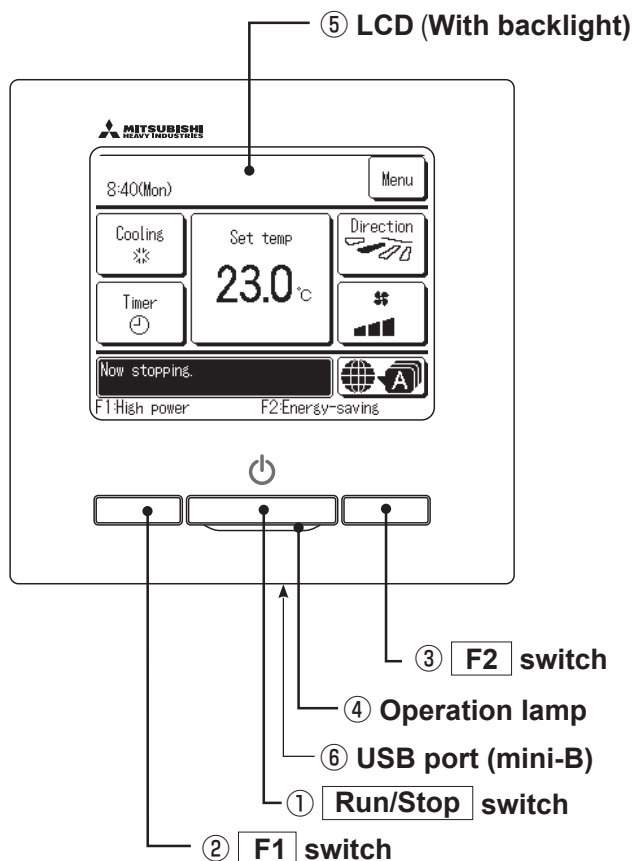

Touch panel system, which is operated by tapping the LCD screen with a finger, is employed for any operations other than the ①Run/Stop, ②F1 and ③F2 switches.

① Run/Stop switch

One push on the button starts operation and another push stops operation.

If the backlight is ON setting, when the screen is tapped while the backlight is turned off, the backlight only is turned on. (Operations with switches ①, ② and ③ are excluded.)

② F1 switch ③ F2 switch

This switch starts operation that is set in F1/F2 function change.

⑥ USB port

USB connector (mini-B) allows connecting to a personal computer. For operating methods, refer to the instruction manual attached to the software for personal computer (remote control utility software).

④ Operation lamp

This lamp lights in green (yellow-green) during operation. It changes to red (orange) if any error occurs. Operation lamp luminance can be changed.

Note(1) When connecting to a personal computer, do not connect simultaneously with other USB devices. Please be sure to connect to the computer directly, without going through a hub, etc.

⑤ LCD (With backlight)

A tap on the LCD lights the backlight. The backlight turns off automatically if there is no operation for certain period of time. Lighting period of the backlight lighting can be changed.

Model RC-E5

The figure below shows the remote control with the cover opened. Note that all the items that may be displayed in the liquid crystal display area are shown in the figure for the sake of explanation. Characters displayed with dots in the liquid crystal display area are abbreviated.

The figure below shows the remote control with the cover opened.

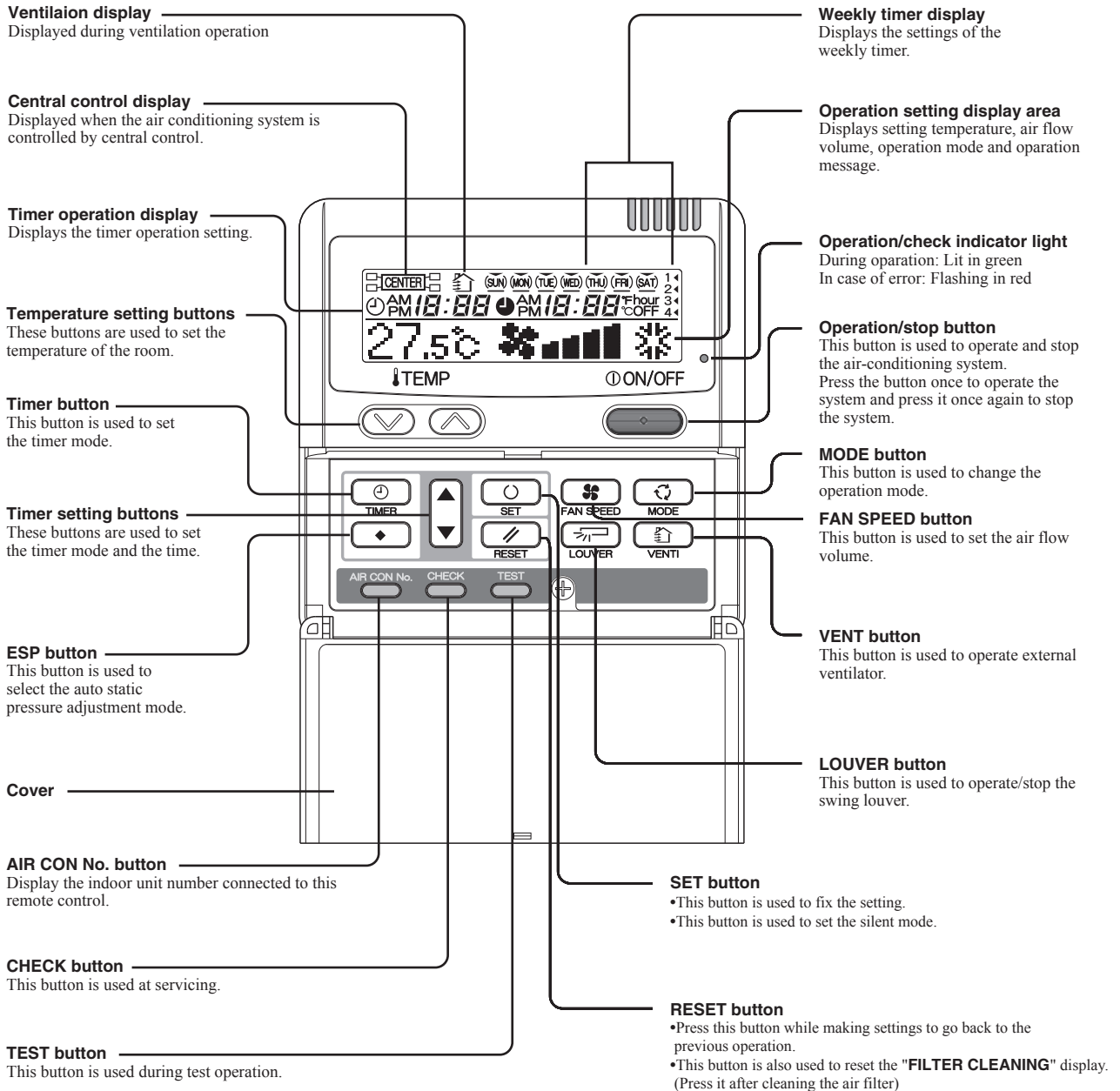

* All displays are described in the liquid crystal display for explanation.

**(2) Wireless remote control
RCN-E2**

Indication section

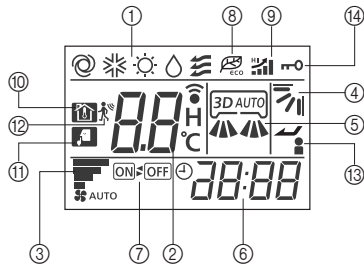

①	OPERATION MODE display SET TEMP display	Indicates selected operation mode. Indicates set temperature.
②	SLEEP TIMER time display Indoor function setting number display	Indicates the amount of time remaining on the sleep timer. Indicates the setting number of the indoor function setting.
③	FAN SPEED display	Indicates the selected air flow volume.
④	UP/DOWN AIR FLOW display	Indicates the up/down louver position.
⑤	LEFT/RIGHT AIR FLOW display	Indicates the left/right louver position.
⑥	Clock display	Indicates the current time. If the timer is set, the ON TIMER and OFF TIMER setting times are indicated.
⑦	ON/OFF TIMER display	Displayed when the timer is set.
⑧	ECO mode display	Displayed when the energy-saving operation is active.
⑨	HI POWER display	Displayed when the high power operation is active.
⑩	NIGHT SETBACK display	Displayed when the home leave mode is active.
⑪	SILENT display	Displayed when the silent mode control is active.
⑫	Motion sensor display	Displayed when the infrared sensor control(motion sensor control) is enabled.
⑬	Anti draft setting display	Displayed when anti draft setting is enabled.
⑭	Child lock display	Displayed when child lock is enabled.

Operation section

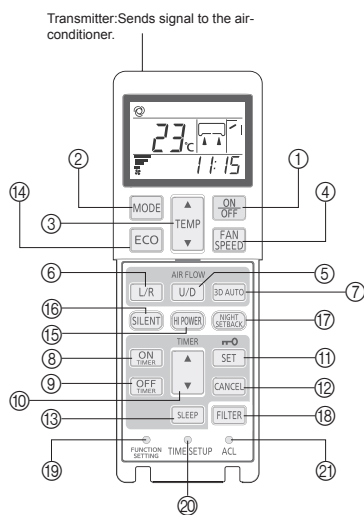

①	ON/OFF button	When this is pressed once, the air-conditioner starts to operate and when this is pressed once again, it stops operating.
②	MODE button	Every time this button is pressed, displays switch as below
③	TEMP button	Change the set temperature by pressing ▲ or ▼ button.
④	FAN SPEED button	The fan speed is switched in the following order: 1-speed → 2-speed → 3-speed → 4-speed → AUTO → 1-speed.
⑤	U/D button	Used to determine the up/down louver position.
⑥	L/R button	Used to determine the left/right louver position.
⑦	3D AUTO button	Used to switch whether or not to enable or disable 3D AUTO mode.
⑧	ON TIMER button	Used to set the ON TIMER.
⑨	OFF TIMER button	Used to set the OFF TIMER.
⑩	SELECT button	Used to switch the time when setting the timer or adjusting the time. Used to switch the settings of the indoor function.
⑪	SET button	Used to determine the setting when setting the timer or adjusting the time. Used to determine the settings of the indoor function. When press and hold SET button ,Child Lock is enabled.
⑫	CANCEL button	Used to cancel the timer setting.
⑬	SLEEP button	Used to set the sleep timer.
⑭	ECO button	Pressing this button starts the energy-saving operation. Pressing this button again cancels it.
⑮	HI POWER button	Pressing this button starts the high power operation. Pressing this button again cancels it.
⑯	SILENT button	Pressing this button starts the silent mode control. Pressing this button again cancels it.
⑰	NIGHT SETBACK button	Pressing this button starts the home leave mode. Pressing this button again cancels it.
⑱	FILTER button	Pressing this button resets FILTER SIGN.
⑲	FUNCTION SETTING switch	Used to set the indoor function.
⑳	TIME SETUP switch	Used to set the current time.
㉑	ACL switch	Used to reset the microcomputer.

1.2 Operation control function by the wired remote control

● Model RC-EX3A

(1) Switching sequence of the operation mode switches of remote control

- Tap the change operation mode button on the TOP screen.
- When the change operation mode screen is displayed, tap the button of desired mode.
- When the operation mode is selected, the display returns to the TOP screen.

Icons displayed have the following meanings.

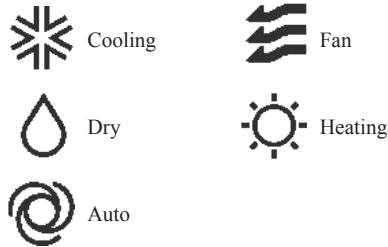

Notes(1) Operation modes which cannot be selected depending on combinations of indoor unit and outdoor unit are not displayed.

- When the Auto is selected, the cooling and heating switching operation is performed automatically according to indoor and outdoor temperatures.

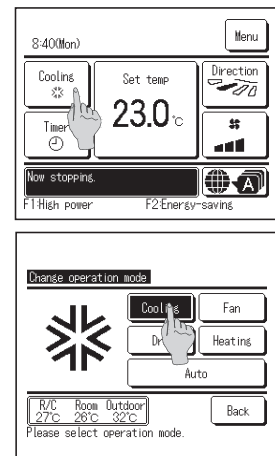

(2) CPU reset

Reset CPU from the remote control as follows.

TOP screen ⇒ ⇒ ⇒

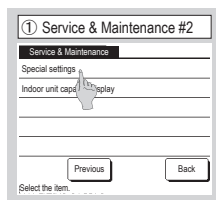

The selected screen is displayed.

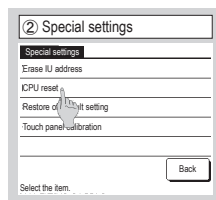

The selected screen is displayed.

Microcomputers of indoor unit and outdoor unit connected are reset (State of restoration after power failure).

(3) Power failure compensation function (Electric power source failure)

Enable the Auto-restart function from the remote control as follows.

TOP screen ⇒ ⇒ ⇒

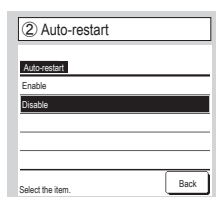
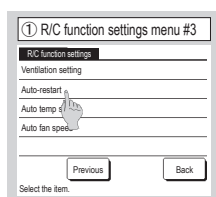

If the unit stops during operation,

It returns to the state before the power failure as soon as the power source is restored (After the end of the primary control at the power on).

It stops after the restoration of power source.

● Since the status of remote control is retained in memory always, it restarts operations according to the contents of memory as soon as the power source is restored. Although the timer mode is cancelled, the weekly timer, peak cut timer and silent mode timer operate according to the following contents:

- When the clock setting is valid : These timer settings are also valid.
- When the clock setting is invalid : These timer settings become “Invalid” since the clock setting is invalid.

These timer settings have to be changed to “Valid” after the timer setting.

●Content memorized with the power failure compensation are as follows.

Note(1) Items (f) and (g) are memorized regardless whether the power failure compensation is effective or not while the setting of silent mode is cancelled regardless whether the power failure compensation is effective or not.

- (a) At power failure – Operating/stopped
If it had been operating under the off timer mode, sleep timer mode, the state of stop is memorized.
- (b) Operation mode
- (c) Air flow volume mode
- (d) Room temperature setting
- (e) Louver auto swing/stop
However, the stop position (4-position) is cancelled so that it returns to Position (1).
- (f) “Remote control function items” which have been set with the administrator or installation function settings (“Indoor function items” are saved in the memory of indoor unit.)
- (g) Weekly timer, peak-cut timer or silent mode timer settings
- (h) Remote control function setting

(4) Alert displays

If the following (a) to (c) appear, check and repair as follows.

(a) Communication check between indoor unit and remote control



- This appears if communications cannot be established between the remote control and the indoor unit.
Check whether the system is correctly connected (indoor unit, outdoor unit, remote control) and whether the power source for the outdoor unit is connected.

(b) Clock setting check

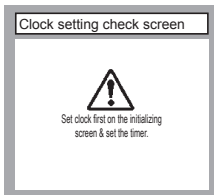

- This appears when the timer settings are done without clock setting.
Set the clock setting before the timer settings.

(c) Misconnection

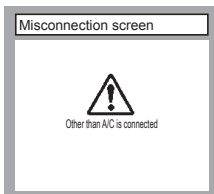

- This appears when something other than the air-conditioner has been connected to the remote control.
Check the location to which the remote control is connected.

● Model RC-E5

(1) Switching sequence of the operation mode switches of remote control



(2) CPU reset

This functions when “CHECK” and “ESP” buttons on the remote control are pressed simultaneously. Operation is same as that of the power source reset.

(3) Power failure compensation function (Electric power source failure)

- This becomes effective if “Power failure compensation effective” is selected with the setting of remote control function.
- Since it memorizes always the condition of remote control, it starts operation according to the contents of memory no sooner than normal state is recovered after the power failure. Although the auto swing stop position and the timer mode are cancelled, the weekly timer setting is restored with the holiday setting for all weekdays. After recovering from the power failure, it readjusts the clock and resets the holiday setting for each weekday so that the setting of weekly timer becomes effective.
- Content memorized with the power failure compensation are as follows.

Note (1) Items (f), (g) and (h) are memorized regardless whether the power failure compensation is effective or not while the setting of silent mode is cancelled regardless whether the power failure compensation is effective or not.

- (a) At power failure – Operating/stopped
If it had been operating under the off timer mode, sleep timer mode, the state of stop is memorized. (Although the timer mode is cancelled at the recovery from power failure, the setting of weekly timer is changed to the holiday setting for all weekdays.)
- (b) Operation mode
- (c) Air flow volume mode
- (d) Room temperature setting
- (e) Louver auto swing/stop
However, the stop position (4-position) is cancelled so that it returns to Position (1).
- (f) “Remote control function items” which have been set with the remote control function setting (“Indoor function items” are saved in the memory of indoor unit.)
- (g) Upper limit value and lower limit value which have been set with the temperature setting control
- (h) Sleep timer and weekly timer settings (Other timer settings are not memorized.)

[Parts layout on remote control PCB]

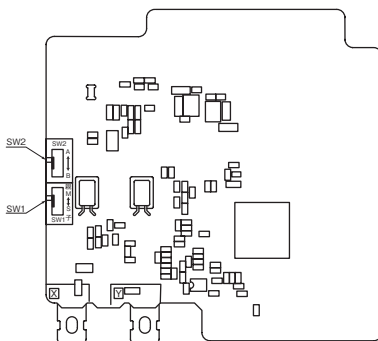

Master/ slave setting when more than one remote controls are used

A maximum of two remote controls can be connected to one indoor unit (or one group of indoor units.)

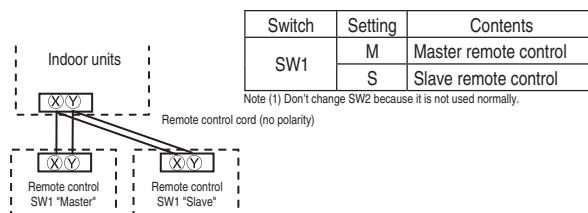

Caution

When using multiple remote controls, the following displays or settings cannot be done with the slave remote control. It is available only with the master remote control.

- ① Louver position setting (set upper or lower limit of swinging range)
- ② Setting indoor unit functions
- ③ Setting temperature range
- ④ Operation data display
- ⑤ Error data display
- ⑥ Silent mode setting
- ⑦ Test operation of drain pump
- ⑧ Remote control sensor setting

1.3 Operation control function by the indoor control

(1) Auto operation

- (a) If "Auto" mode is selected by the remote control, the heating and the cooling are automatically switched according to the difference between outdoor air temperature and setting temperature and the difference between setting temperature and return air temperature. (When the switching of cooling mode ↔ heating mode takes place within 3 minutes, the compressor does not operate for 3 minutes by the control of 3-minute timer.) This will facilitate the cooling/heating switching operation in intermediate seasons and the adaptation to unmanned operation at stores, etc (ATM corner of bank).

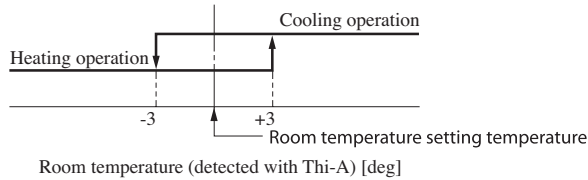

Notes (1) Temperature range of switching cooling/heating mode can be changed by RC-EX3 from ±1.0 - ±4.0.

- (2) Room temperature control during auto cooling/auto heating is performed according to the room temperature setting temperature. (DIFF: ±1 deg)
- (3) If the indoor heat exchanger temperature rises to 59°C or higher during heating operation, it is switched automatically to cooling operation. In addition, for 1 hour after this switching, the heating operation is not performed, regardless of the temperature shown at right.

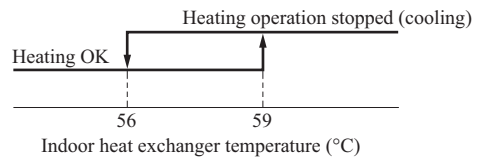

- (b) The following automatic controls are performed other than (a) above.
- (i) Cooling or heating operation mode is judged according to the conditions of the "Judgment based on Setting temperature + Cooling select temperature and Indoor return air temperature" and the "Judgment based on Outdoor temperature".
 - 1) In "Setting temperature - Cooling select temperature < Indoor return air temperature" and "Outdoor temperature/Cooling < Outdoor return air temperature" ⇒ Operation mode: Cooling
 - 2) "Setting temperature + Heating select temperature > Indoor return air temperature" and "Outdoor temperature/Heating > Outdoor air temperature" ⇒ Operation mode: Heating
 - 3) The outdoor air temperature of the above judgment conditions is sampled at every 10 minutes.
 - 4) In the range where the above cooling and heating zones are overlapped ⇒ Forced thermostat OFF

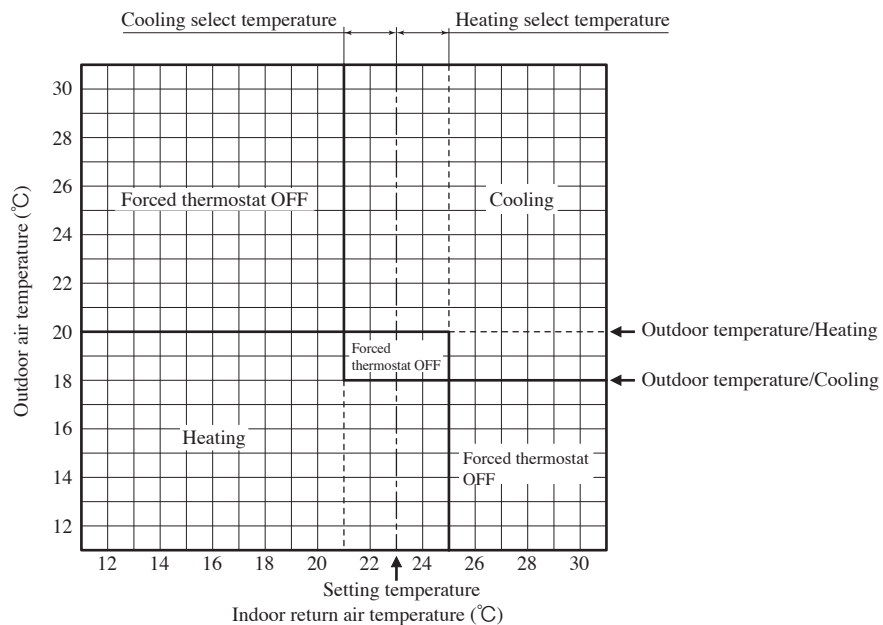

- (ii) Regardless of the setting temperature, the cooling or heating operation mode is judged according to the "Judgment based on Room temperature/Cooling or Heating and Outdoor temperature/Cooling or Heating".
- 1) In case of "Room temperature/Cooling < Indoor return air temperature" and "Outdoor temperature/Cooling < Outdoor air temperature" ⇒ Operation mode: Cooling
 - 2) In case of "Room temperature/Heating > Indoor return air temperature" and "Outdoor temperature /Heating > Outdoor air temperature" ⇒ Operation mode: Heating
 - 3) The outdoor air temperature of the above judgment conditions is sampled at every 10 minutes.
 - 4) In the range where the above cooling and heating zones are overlapped ⇒ Forced thermostat OFF

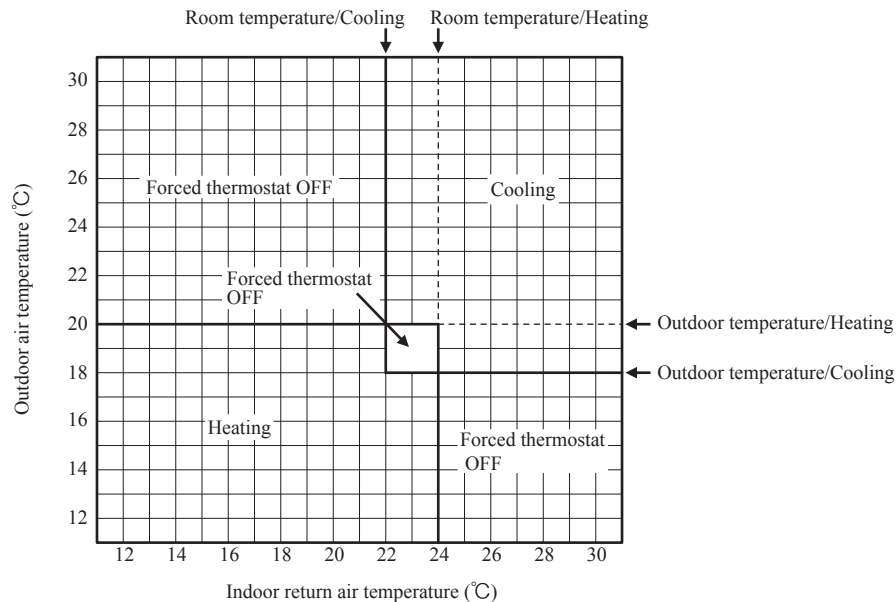

(2) Operations of functional items during cooling/heating

Operation Functional item	Cooling		Fan	Heating			Dehumidifying
	Thermostat ON	Thermostat OFF		Thermostat ON	Thermostat OFF	Hot start (Defrost)	
Compressor	○	×	×	○	×	○	○/×
4-way valve	×	×	×	○	○	○(×)	×
Outdoor unit fan	○	×	×	○	×	○(×)	○/×
Indoor unit fan	○	○	○	○/×	○/×	○/×	○/×
Drain pump ⁽³⁾	○	× ⁽²⁾	× ⁽²⁾	○/× ⁽²⁾			Thermostat ON: ○ Thermostat OFF: × ⁽²⁾

Notes (1) ○: Operation ×: Stop ○/×: Turned ON/OFF by the control other than the room temperature control.

(2) ON during the drain motor delay control.

(3) Drain pump ON setting may be selected with the indoor unit function setting of the wired remote control.

(3) Dehumidifying (DRY) operation

Indoor ambient temperatures and humidity are controlled simultaneously with the relative humidity sensor (HS) and the suction temperature sensor [Thi-A (or the remote control sensor when it is activated)], which are installed at the suction inlet.

- (a) When the operation has been started with cooling, if there is a difference of 2°C or less between the suction and setting temperatures, the tap of indoor fan is lowered by one tap. This tap is retained for 3 minutes after changing the tap.
- (b) After the above condition, when a difference between suction and setting temperature is lower than 3°C, and the relative humidity is high, the tap of indoor unit fan is lowered by one tap.
When the difference between suction and setting temperature is larger than 3°C, the fan of indoor unit fan is raised by one tap. This tap is retained for 3 minutes after changing the tap.
- (c) When relative humidity becomes lower, the indoor unit fan tap is retained.
- (d) In case of the thermostat OFF, the indoor unit fan tap at the thermostat ON is retained.

(4) Timer operation

(a) RC-EX3A

- (i) **Sleep timer**
Set the time from the start to stop of operation. The time can be selected in the range from 30 to 240 minutes (in the unit of 10-minute).
Note (1) Enable the “Sleep timer” setting from the remote control. If the setting is enabled, the timer operates at every time.
- (ii) **Set OFF timer by hour**
Set the time to stop the unit after operation, in the range from 1 to 12 hours (in the unit of hour).
- (iii) **Set ON timer by hour**
Set the time to start the unit after the stop of operation, in the range from 1 to 12 hours (in the unit of hour). It is allowed also to set simultaneously the indoor temperature, operation mode, air flow rate and warm-up enabled/disabled.
- (iv) **Set ON timer by clock**
Set the time to start operation. The time can be set in the unit of 5-minute. This setting can be activated only once or at every time. It is allowed also to set simultaneously the indoor temperature, operation mode, air flow rate and warm-up enabled/disabled.
Note (1) It is necessary to set the clock to use this timer.
- (v) **Set OFF timer by clock**
Set the time to stop operation. The time can be set in the unit of 5-minute. This setting can be activated only once or at every time.
Note (1) It is necessary to set the clock to use this timer.
- (vi) **Weekly timer**
Set the ON or OFF timer for a week. Up to 8 patterns can be set for a day. The day-off setting is provided for holidays and non-business days.
Note (1) It is necessary to set the clock to use the weekly timer.

(vii) Combination of patterns which can be set for the timer operations

	Sleep time	Set OFF timer by hour	Set ON timer by hour	Set OFF timer by clock	Set ON timer by clock	Weekly timer
Sleep time		×	×	○	○	○
Set OFF timer by hour	×		×	×	×	×
Set ON timer by hour	×	×		×	×	×
Set OFF timer by clock	○	×	×		○	×
Set ON timer by clock	○	×	×	○		×
Weekly timer	○	×	×	×	×	

Note (1) ○: Allowed ×: Not

(b) RC-E5

- (i) **Sleep timer**
Set the duration of time from the present to the time to turn off the air-conditioner.
It can be selected from 10 steps in the range from “OFF 1 hour later” to “OFF 10 hours later”. After the sleep timer setting, the remaining time is displayed with progress of time in the unit of hour.
- (ii) **OFF timer**
Time to turn OFF the air-conditioner can be set in the unit of 10 minutes.
- (iii) **ON timer**
Time to turn ON the air-conditioner can be set. Indoor temperature can be set simultaneously.
- (iv) **Weekly timer**
Timer operation (ON timer, OFF timer) can be set up to 4 times a day for each weekday.
- (v) **Timer operations which can be set in combination**

Item	Item	Timer	OFF timer	ON timer	Weekly timer
Timer			×	○	×
OFF timer	×			○	×
ON timer	○		○		×
Weekly timer	×	×	×	×	

Note (1) ○: Allowed ×: Not

(2) Since the ON timer, sleep timer and OFF timer are set in parallel, when the times to turn ON and OFF the air-conditioner are duplicated, the setting of the OFF timer has priority.

(5) Hot start (Cold draft prevention at heating)**(a) Operating conditions**

When either one of following conditions is satisfied, the hot start control is performed.

- (i) From stop to heating operation
- (ii) From cooling to heating operation
- (iii) Form heating thermostat OFF to ON
- (iv) After completing the defrost operation (only on units with thermostat ON)

(b) Contents of operation**(i) Indoor fan motor control at hot start**

- 1) Within 7 minutes after starting heating operation, the fan mode is determined depending on the condition of thermostat (fan control with heating thermostat OFF).

a) Thermostat OFF

- i) Operates according to the fan control setting at heating thermostat OFF.
- ii) Even if it changes from thermostat OFF to ON, the fan continues to operate with the fan control at thermostat OFF till the heat exchanger thermistor (Thi-R1 or R2, whichever higher) detects 35°C or higher.
- iii) When the heat exchanger thermistor (Thi-R1 or R2, whichever higher) detects 35°C or higher, the fan operates with the set air flow volume.

b) Thermostat ON

- i) When the heat exchanger thermistor (Thi-R1 or R2, whichever higher) detects 25°C or lower, the fan is turned OFF and does not operate.
- ii) When the heat exchanger thermistor (Thi-R1 or R2, whichever higher) detects 25°C or higher, the fan operates with the fan control at heating thermostat OFF.
- iii) When the heat exchanger thermistor (Thi-R1 or R2, whichever higher) detects 35°C or higher, the fan operates with the set air flow volume.

- c) If the fan control at heating thermostat OFF is set at the “Set air flow volume” (from the remote control), the fan operates with the set air flow volume regardless of the thermostat ON/OFF.

- 2) Once the fan motor is changed from OFF to ON during the thermostat ON, the indoor fan motor is not turned OFF even if the heat exchanger thermistor detects lower than 25°C.

Note (1) When the defrost control signal is received, it complies with the fan control during defrost operation.

- 3) Once the hot start is completed, it will not restart even if the temperature on the heat exchanger thermistor drops.

- (ii) During the hot start, the louver is kept at the horizontal position.
- (iii) When the fan motor is turned OFF for 7 minutes continuously after defrost operation, the fan motor is turned ON regardless of the temperatures detected with the indoor heat exchanger thermistors (Thi-R1, R2).

(c) Ending condition

- (i) If one of following conditions is satisfied during the hot start control, this control is terminated, and the fan is operated with the set air flow volume.

- 1) Heat exchanger thermistor (Thi-R1 or R2, whichever higher) detects 35°C or higher.
- 2) It has elapsed 7 minutes after starting the hot start control.

(6) Hot keep

Hot keep control is performed at the start of the defrost operation.

(a) Control

- (i) When the indoor heat exchanger temperature (detected with Thi-R1 or R2) drops to less than 35°C, the speed of indoor fan follows fan setting at the time of thermostat OFF.
- (ii) During the hot keep, the louver is kept at the horizontal position.

(7) Auto swing control

Note Even if [Auto Swing] is selected, the louver position with anti draft function is fixed to position 1.

(a) RC-EX3A**(i) Louver control**

- 1) To operate the swing louver when the air-conditioner is operating, press the “Direction” button on the TOP screen of remote control. The wind direction select screen will be displayed.
- 2) To swing the louver, touch the “Auto swing” button. The louver will move up and down. To fix the swing louver at a position, touch one of [1] - [4] buttons. The swing louver will stop at the selected position.
- 3) Louver operation at the power on with a unit having the louver 4-position control function
The louver swings one time automatically (without operating the remote control) at the power on.
This allows the microcomputer recognizing and inputting the louver motor (LM) position.

(ii) Automatic louver level setting during heating

At the hot start and the heating thermostat OFF, regardless whether the auto swing switch is operated or not (auto swing or louver stop), the louver takes the level position (in order to prevent blowing of cool wind). The louver position display LCD continues to show the display which has been shown before entering this control.

(iii) Louver free stop control

If you touch the “Menu” → “Next” → “R/C settings” buttons one after another on the TOP screen of remote control, the “Flap control” screen is displayed. If the free stop is selected on this screen, the louver motor stops upon receipt of the stop signal from the remote control. If the auto swing signal is received from the remote control, the auto swing will start from the position before the stop.

(b) RC-E5**(i) Louver control**

- 1) Press the “LOUVER” button to operate the swing louver when the air-conditioner is operating.
“SWING 扇” is displayed for 3 seconds and then the swing louver moves up and down continuously.
- 2) To fix the swing louver at a position, press one time the “LOUVER” button while the swing louver is moving so that four stop positions are displayed one after another per second.
When a desired stop position is displayed, press the “LOUVER” button again. The display stops, changes to show the “STOP 1 一” for 5 seconds and then the swing louver stops.
- 3) Louver operation at the power on with a unit having the louver 4-position control function
The louver swings one time automatically (without operating the remote control) at the power on.
This allows inputting the louver motor (LM) position, which is necessary for the microcomputer to recognize the louver position.

Note (1) If you press the “LOUVER” button, the swing motion is displayed on the louver position LCD for 10 seconds. The display changes to the “SWING 扇” display 3 seconds later.

(ii) Automatic louver level setting during heating

At the hot start with the heating thermostat OFF, regardless whether the auto swing switch is operated or not (auto swing or louver stop), the louver takes the level position (In order to prevent the cold start). The louver position display LCD continues to show the display which has been shown before entering this control.

(iii) Louver-free stop control

When the louver-free stop has been selected with the indoor function of wired remote control “扇 POSITION”, the louver motor stops when it receives the stop signal from the remote control. If the auto swing signal is received from the remote control, the auto swing will start from the position where it was before the stop.

Note (1) When the indoor function of wired remote control “扇 POSITION” has been switched, switch also the remote control function “扇 POSITION” in the same way.

(8) Thermostat operation**(a) Cooling**

- (i) Thermostat is operated with the room temperature control.
- (ii) Thermostat is turned ON or OFF relative to the set room temperature as shown below.

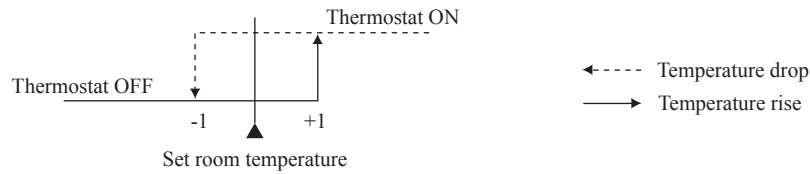

- (iii) Thermostat is turned ON when the room temperature is in the range of $-1 < \text{Set temperature} < +1$ at the start of cooling operation (including from heating to cooling).

(b) Heating

- (i) Thermostat is operated with the room temperature control.
- (ii) Thermostat is turned ON or OFF relative to the set room temperature as shown below.

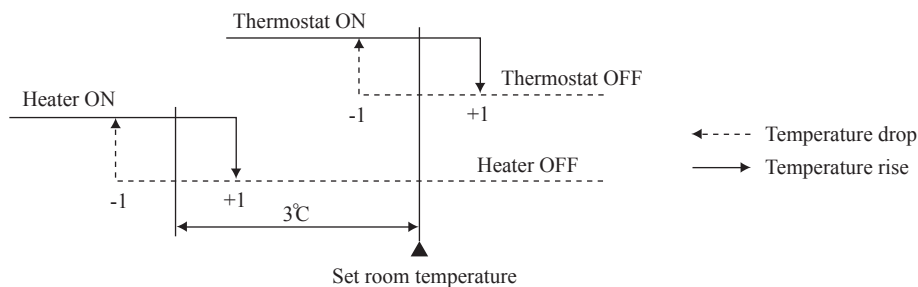

- (iii) Thermostat is turned ON when the room temperature is in the range of $-1 < \text{Set point} < +1$ at the start of heating operation (including from cooling to heating).

(c) Fan control during heating thermostat OFF

- (i) Following fan controls during the heating thermostat OFF can be selected with the indoor function setting of the wired remote control.
 - ① Low fan speed (Factory default), ② Set fan speed, ③ Intermittence, ④ Fan OFF
- (ii) When the “Low fan speed (Factory default)” is selected, the following taps are used for the indoor fans.
 - For DC motor : ULo tap
- (iii) When the “Set fan speed” is selected, it is operated with the set fan speed also in the thermostat OFF condition.
- (iv) If the “Intermittence” is selected, following controls are performed:
 - 1) If the thermostat is turned OFF during the heating operation, the indoor unit moves to the hot control and turns OFF the indoor fan if the heat exchanger thermistors (both Thi-R1 and R2) detect 25°C or lower.
 - 2) Indoor fan OFF is fixed for 5 minutes. After the 5 minutes, the indoor fan is operated at ULo for 2 minutes. In the meantime the louver is controlled at level.
 - 3) After operating at ULo for 2 minutes, the indoor fan moves to the state of 1) above.
 - 4) If the thermostat is turned ON, it moves to the hot start control.
 - 5) When the heating thermostat is turned OFF, the remote control displays the temperature detected at the fan stop and revises the temperature later when the indoor fan changes from ULo to stop.

The remote control uses the operation data display function to display temperatures and updates values of temperature even when the indoor fan is turned OFF.
 - 6) When the defrosting starts while the heating thermostat is turned OFF or the thermostat is turned OFF during defrosting, the indoor fan is turned OFF. (Hot keep or hot start control takes priority.) However, the suction temperature is updated at every 7-minute.
 - 7) When the heating thermostat is turned ON or the operation is changed to another mode (including stop), this control is stopped immediately, and the operating condition is restored.
- (v) When the “Fan OFF” is selected, the fan on the indoor unit of which the thermostat has been turned OFF, is turned OFF. The same occurs also when the remote control sensor is effective.

(d) Fan control during cooling thermostat OFF

- (i) Following fan controls during the cooling thermostat OFF can be selected with the indoor function setting of the wired remote control.
 - ① Low fan speed, ② Set fan speed (Factory default), ③ Intermittence, ④ Fan OFF
- (ii) When the “Low fan speed” is selected, the following taps are used for the indoor fans.
 - For DC motor : ULo tap
- (iii) When the “Set fan speed” is selected, it is operated with the set fan speed also in the thermostat OFF condition.
- (iv) If the “Intermittence” is selected, following controls are performed:
 - 1) If the thermostat is turned OFF during the cooling operation, the indoor unit fan motor stope.
 - 2) Indoor fan OFF is fixed for 5 minutes. After the 5 minutes, the indoor fan is operated at ULo for 2 minutes. In the meantime the louver is controlled at level.
 - 3) After operating at ULo for 2 minutes, the indoor fan moves to the state of 1) above.
 - 4) If the thermostat is turned ON, the fan starts operation at set fan speed.
 - 5) When the cooling thermostat is turned OFF, the remote control displays the temperature detected at the fan stop and revises the temperature later when the indoor fan changes from ULo to stop.
By using operation data display function at wireless remote control, the temperature as displayad and the value is updated including the fan stops.
 - 6) When the cooling thermostat is turned ON or the operation is changed to another mode (including stop), this control is stopped immediately, and the operating condition is restored.
- (v) When the “Fan OFF” is selected, the fan on the indoor unit of which the thermostat has been turned OFF, is turned OFF. The same occurs also when the remote control sensor is effective.

(9) Filter sign

As the operation time (Total ON time of ON/OFF switch) accumulates to 180 hours (1), “FILTER CLEANING” is displayed on the remote control. (This is displayed when the unit is in trouble and under the centralized control, regardless of ON/OFF)

Notes (1) Time setting for the filter sign can be made as shown below using the indoor function of wired remote control “Filter sign”. (It is set at setting 1 at the shipping from factory.)

Filter sign setting	Function
Setting 1	Setting time: 180 hrs (Factory default)
Setting 2	Setting time: 600 hrs
Setting 3	Setting time: 1,000 hrs
Setting 4	Setting time: 1,000 hrs (Unit stop) (2)

(2) After the setting time has elapsed, the “FILTER CLEANING” is displayed and, after operating for 24 hours further (counted also during the stop), the unit stops.

(10) Compressor inching prevention control

(a) 3-minute timer

When the compressor has been stopped by the thermostat, remote control operation switch or anomalous condition, its restart will be inhibited for 3 minutes. However, the 3-minute timer is invalidated at the power on the electric power source for the unit.

(b) 3-minute forced operation timer

- (i) Compressor will not stop for 3 minutes after the compressor ON. However, it stops immediately when the unit is stoppe d by means of the ON/OFF switch or by when the thermister turned OFF the change of operation mode.
- (ii) If the thermostat is turned OFF during the forced operation control of heating compressor, the louver position (with the auto swing) is returned to the level position.

Note (1) The compressor stops when it has entered the protective control.

(11) Drain pump control

- (a) This control is operated when the inverter frequency is other than 0 Hz during the cooling operation and automatic cooling and dehumidifying operations.
- (b) Drain pump ON condition continues for 5 minutes even when it enters the OFF range according to (i) above after turning the drain pump ON, and then stops. The 5-minute delay continues also in the event of anomalous stop.
- (c) The drain pump is operated with the 5-minute delay operation when the compressor is changed from ON to OFF.
- (d) Even in conditions other than the above (such as heating, fan, stop, cooling thermostat OFF), the drain pump control is performed by the drain detection.
- (e) Following settings can be made using the indoor function setting of the wired remote control.
 - (i) 标准 [Standard (in cooling & dry)] : Drain pump is run during cooling and dry.
 - (ii) 标准+制热 [Operate in standard & heating] : Drain pump is run during cooling, dry and heating.
 - (iii) 标准+制热+风扇 [Operate in heating & fan] : Drain pump is run during cooling, dry, heating and fan.
 - (iv) 标准+风扇 [Operate in standard & fan] : Drain pump is run during cooling, dry and fan.

Note (1) Values in [] are for the RC-EX3A model.

(12) Drain pump motor (DM) control

- (a) Drain detection switch is turned ON or OFF with the float switch (FS) and the timer.

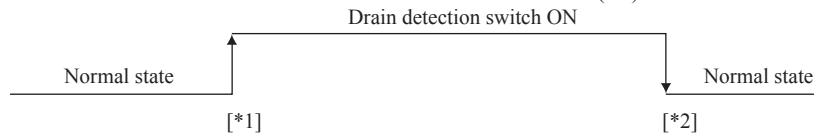

[*1] Drain detection switch is turned “ON” when the float switch “Open” is detected for 3 seconds continuously in the drain detectable space.

[*2] Drain detection switch is turned “OFF” when the float switch “Close” is detected for 10 seconds continuously.

- (i) It detects always from 30 seconds after turning the power ON.
 - 1) There is no detection of anomalous draining for 10 seconds after turning the drain pump OFF.
 - 2) Turning the drain detection switch “ON” causes to turn ON the drain pump forcibly.
 - 3) Turning the drain detection switch “OFF” releases the forced drain pump ON condition.
- (b) Indoor unit performs the control A or B depending on each operating condition.

	Indoor unit operation mode				
	Stop ⁽¹⁾	Cooling	Dry	Fan ⁽²⁾	Heating
Compressor ON		Control A			
Compressor OFF		Control B			

Notes (1) Including the stop from the cooling, dehumidifying, fan and heating, and the anomalous stop
 (2) Including the “Fan” operation according to the mismatch of operation modes

- (i) Control A
 - 1) If the float switch detects any anomalous draining condition, the unit stops with the anomalous stop (displays E9) and the drain pump starts. After detecting the anomalous condition, the drain motor continues to be ON.
 - 2) It keeps operating while the float switch is detecting the anomalous condition.
- (ii) Control B

If the float switch detects any anomalous drain condition, the drain motor is turned ON for 5 minutes, and at 10 seconds after the drain motor OFF it checks the float switch. If it is normal, the unit is stopped under the normal mode or, if there is any anomalous condition, E9 is displayed and the drain motor is turned ON. (The ON condition is maintained during the drain detection.)

(13) Operation check/drain pump test run operation mode

- (a) If the power is turned on by the DIP switch (SW7-1) on the indoor unit control PCB when electric power source is supplied, it enters the mode of operation check/drain pump test run. It is ineffective (prohibited) to change the switch after turning power on.
- (b) When the communication with the remote control has been established within 60 seconds after turning power on by the DIP switch (SW7-1) ON, it enters the operation check mode. Unless the remote control communication is established, it enters the drain pump test run mode.

Note (1) To select the drain pump test run mode, disconnect the remote control connector (CNB) on the indoor PCB to shut down the remote control communication.

(c) Operation check mode

There is no communication with the outdoor unit but it allows performing operation in respective modes by operating the remote control.

(d) Drain pump test run mode

As the drain pump test run is established, the drain pump only operates and during the operation protective functions by the microcomputer of indoor unit become ineffective.

(14) Cooling, dehumidifying frost protection

- (a) To prevent frosting during cooling mode or dehumidifying mode operation, the thermostat-OFF if the indoor heat exchanger temperature (detected with Thi-R) drops to 1.0 °C or lower at 4 minutes after the thermostat-ON. If the indoor unit heat exchanger temperature is 1.0 °C or lower after 5 minutes, the indoor unit is controlled thermostat-OFF. If it becomes 10°C or higher, the control terminates. When the indoor heat exchanger temperature has become as show, the indoor unit send outdoor unit the “Anti-frost” signal.

- Frost prevention temperature setting can be selected with the indoor unit function setting of the wired remote control.

Item	Symbol	A
Temperature - Low (Factory default)		1.0
Temperature - High		2.5

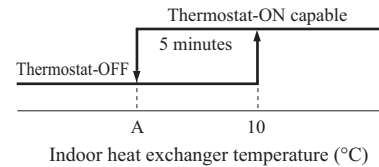

(b) Selection of indoor fan speed

If it enters the frost prevention control during cooling operation (excluding dehumidifying), the indoor fan speed is switched.

- (i) When the indoor return air detection temperature (detected with Thi-A) is 18°C or higher and the indoor heat exchanger temperature (detected with Thi-R) detects the compressor frequency drop start temperature A°C+1°C, of indoor fan speed is increased by 20min⁻¹.
- (ii) If the phenomenon of (i) above is detected again after the acceleration of indoor fan, indoor fan speed is increased further by 20min⁻¹.

Note (1) Indoor fan speed can be increased by up to 2 taps.

- Compressor frequency drop start temperature

Hs > 50%

Symbol	Item	Low	High
A		1.0	2.5
B		2.5	4.0

Hs ≤ 50%

Symbol	Item	Low	High
A		-0.5	1.0
B		1.0	2.5

Note (1) Frost prevention temperature setting can be selected with the indoor unit function setting of the wired remote control.

(15) Heating overload protection

- (a) If the indoor heat exchanger temperature (detected with Thi-R) at 63°C or higher is detected for 2 seconds continuously, the compressor stops. When the compressor is restarted after a 3-minute delay, if a temperature at 63°C or higher is detected for 2 seconds continuously within 60 minutes after initial detection and if this is detected 5 times consecutively, the compressor stops with the anomalous stop (E8). Anomalous stop occurs also when the indoor heat exchanger temperature at 63°C or higher is detected for 6 minutes continuously.

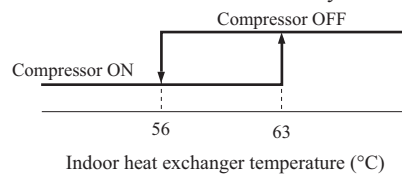

(b) Indoor unit fan speed selection

If, after second detection of heating overload protection up to fourth, the indoor fan is set at below Hi tap when the compressor is turned ON, the indoor fan speed is increased by 1 tap.

(16) Anomalous fan motor

- (a) After starting the fan motor, if the fan motor speed is 200 min⁻¹ or less is detected for 30 seconds continuously and 4 times within 60 minutes, then fan motor stops with the anomalous stop (E16).
- (b) If the fan motor fails to reach at -50 min⁻¹ less than the required speed, it stops with the anomalous stop (E20).

(17) Plural unit control – Control of 16 units group by one remote control

(a) Function

One remote control can control a group of multiple number of unit (Max. 16 indoor units). “Operation mode” which is set by the remote control can operate or stop all units in the group one after another in the order of unit No.⁽¹⁾. Thermostat and protective function of each unit function independently.

Note (1) Unit No. is set by SW2 on the indoor control PCB. Unit No. setting by SW2 is necessary for the indoor unit only.

SW2: For setting of 0 – 9, A – F

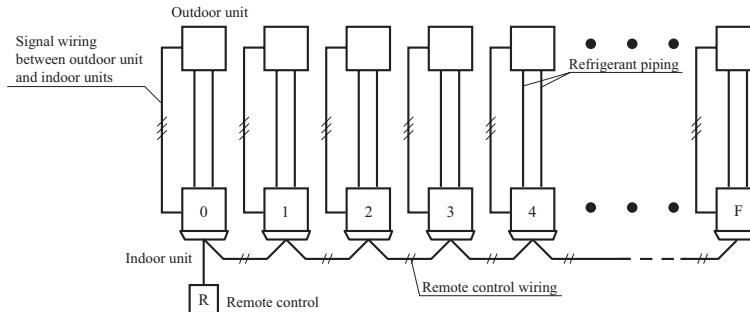

(2) Unit No. may be set at random unless duplicated, it should be better to set orderly like 0, 1, 2..., F to avoid mistake.

(b) Display to the remote control

- (i) Central or each remote control basis, heating preparation: the smallest unit No. among the operating units in the remote mode (or the center mode unless the remote mode is available) is displayed.
- (ii) Inspection display, filter sign: Any of unit that starts initially is displayed.

(c) Confirmation of connected units

- (i) In case of RC-EX3A remote control
If you touch the buttons in the order of “Menu” → “Service setting” → “Service & Maintenance” → “Service password” → “IU address” on the TOP screen of remote control, the indoor units which are connected are displayed.
- (ii) In case of RC-E5 remote control
Pressing “AIR CON No.” button on the remote control displays the indoor unit address. If “▲” “▼” button is pressed at the next, it is displayed orderly starting from the unit of smallest No.

(d) In case of anomaly

If any anomaly occurs on a unit in a group (a protective function operates), that unit stops with the anomalous stop but any other normal units continue to run as they are.

(e) Signal wiring procedure

Signal wiring between indoor and outdoor units should be made on each unit same as the normal wiring. For the group control, connect the remote control wiring to each indoor unit via terminal block for the remote control.

Connect the remote control wiring separately from the power source cable or wires of other electric devices (AC220V or higher).

(18) High ceiling control

When sufficient air flow rate cannot be obtained from the indoor unit which is installed at a room with high ceiling, the air flow rate can be increased by changing the fan tap. To change the fan tap, use the indoor unit function “FAN SPEED SET” on the wired remote control.

Fan tap		Indoor unit air flow setting			
		■ ■ ■ ■ - ■ ■ ■ ■ - ■ ■ ■ ■ - ■ ■ ■ ■	■ ■ ■ ■ - ■ ■ ■ ■ - ■ ■ ■ ■	■ ■ ■ ■ - ■ ■ ■ ■	■ ■ ■ ■ - ■ ■ ■ ■
FAN SPEED SET	STANDARD	P-Hi2 - Hi - Me - UL0	Hi - Me - UL0	Hi - UL0	Hi - Me
	HIGH SPEED1	P-Hi2 - P-Hi1 - Hi - Me	P-Hi1 - Hi - Me	P-Hi1 - Me	P-Hi1 - Hi
	HIGH SPEED2	P-Hi2 - Hi - Me - UL0	Hi - Me - UL0	Hi - UL0	Hi - Me

Notes (1) Factory default is STANDARD.

(2) At the hot-start and heating thermostat OFF, or other, the indoor unit fan is operated at the low speed tap of each setting.

(3) This function is not able to be set with wireless remote controls or simple remote control (RCH-E3).

(19) Abnormal temperature sensor (return air/indoor heat exchanger) broken wire/short-circuit detection

(a) Broken wire detection

When the return air temperature sensor detects -55°C or lower or the heat exchanger temperature sensor detect -55°C or lower for 5 seconds continuously, the compressor stops. After a 3-minute delay, the compressor restarts but, if it is detected again within 60 minutes after the initial detection for 6 minutes continuously, stops again (the return air temperature sensor : E7, the heat exchanger temperature sensor : E6).

(b) Short-circuit detection

If the heat exchanger temperature sensor detects short-circuit for 5 seconds continuously at 2 minutes and 20 seconds after the compressor ON during cooling operation, the compressor stops (E6).

(20) External input/output control (CnT or CnTA)

External input/output connectors are provided on the indoor unit control PCB, and each input/output is possible to be changed by RC-EX3A.

Be sure to connect the wired remote control to the indoor unit. Remote operation with CnT/CnTA only is not possible.

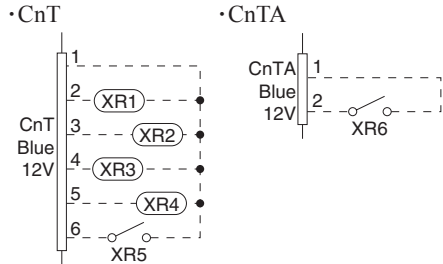

Input/Output	Connector	Factory default setting	RC-EX3A function name
Output	CnT-2 (XR1)	Operation output	External output 1
	CnT-3 (XR2)	Heating output	External output 2
	CnT-4 (XR3)	Compressor ON output	External output 3
	CnT-5 (XR4)	Inspection(Error) output	External output 4
"Input (Volt-free contact)"	CnT-6 (XR5)	Remote operation input	External input 1
	CnTA (XR6)	Remote operation input	External input 2

■ Priority order for combinations of CnT and CnTA input.

		CnTA					
		① Operation stop level	② Operation stop pulse	③ Operation permission/prohibition	④ Operation permission/prohibition pulse	⑤ Cooling/heating selection level	⑥ Cooling/heating selection pulse
CnT	① Operation stop level	CnT ①	CnT ①	CnT ① + CnTA ②	CnT ①	CnT ① / CnTA ⑤	CnT ① / CnTA ⑥
	② Operation stop pulse	CnT ②	CnT ②	CnT ② + CnTA ③	CnT ②	CnT ② / CnTA ⑤	CnT ② / CnTA ⑥
	③ Operation permission/prohibition level	CnT ③ > CnTA ①	CnT ③ > CnTA ②	CnT ③ + CnTA ③	CnT ③	CnT ③ / CnTA ⑤	CnT ③ / CnTA ⑥
	④ Operation permission/prohibition pulse	CnT ④	CnT ④	CnT ④ + CnTA ③※	CnT ④	CnT ④ / CnTA ⑤	CnT ④ / CnTA ⑥
	⑤ Cooling/heating selection level	CnT ⑤ / CnTA ①	CnT ⑤ / CnTA ②	CnT ⑤ / CnTA ③	CnT ⑤ / CnTA ④	CnT ⑤	CnT ⑤
	⑥ Cooling/heating selection pulse	CnT ⑥ / CnTA ①	CnT ⑥ / CnTA ②	CnT ⑥ / CnTA ③	CnT ⑥ / CnTA ④	CnT ⑥	CnT ⑥

Note (1) Following operation commands are accepted when the operation prohibition is set with CnTA as indicated with *.

Individual operation command from remote control, test run command from outdoor unit and operation command from option device, CnT input.

Reference: Explanation on the codes and the combinations of codes in the table above

- In case of CnT "Number", the CnT "Number" is adopted and CnTA is invalidated.
- In case of CnTA "Number", the CnTA "Number" is adopted and CnT is invalidated.
- In case of CnT "Number"/CnTA "Number", the CnT "Number" and the CnTA "Number" become independent functions each other.
- In case of CnT "Number" + CnTA "Number", the CnT "Number" and the CnTA "Number" become competing functions each other.
- In case of CnT "Number" > CnTA "Number", the function of CnT "Number" supersedes that of CnTA "Number".
- In case of CnT "Number" < CnTA "Number", the function of CnTA "Number" supersedes that of CnT "Number". (The "Number" above means ① - ⑥ in the table.)

(a) Output for external control (remote display)

Indoor unit outputs the following signal for operation status monitoring.

	Output name	Condition
1	Operation output	During operation
2	Heating output	During heating operation
3	Compressor ON output	During compressor operation
4	Inspection(Error) output	When anomalous condition occurs.
5	Cooling output	During cooling operation
6	Fan operation output 1	When indoor unit's fan is operating
7	Fan operation output 2	When indoor unit's fan is operating, and fan speed is higher than Hi speed.
8	Fan operation output 3	When indoor unit's fan is operating, and fan speed is Lower than Me speed.
9	Defrost/oil return output	When indoor unit receive defrost/oil return signal from the outdoor unit.
10	Ventilation output	When "Venti.ON" is selected from remote control
11	Free cooling output	When the ambient temp. is between 10 - 18°C in cooling and fan operation
12	Indoor unit overload alarm output	Refer to "IU overload alarm"
13	Heater output	Refer to "(8) Thermostat operation (b) Heating"

(b) Input for external control

The external input for the indoor unit can be selected from the following input.

	Input name	Content
1	Run/Stop	Refer to [(20) (c) Remote operation input]
2	Permission/Prohibition	Refer to [(21) Operation permission/prohibition]
3	Cooling/Heating	Refer to [(23) Selection of cooling/heating external input function]
4	Emergency stop	Indoor/outdoor units stop the operation, and [E63] is displayed.
5	Setting temperature shift	Set temperature is shifted by +2/-2°C in cooling/heating.
6	Forced thermo-OFF	Unit goes thermo off.
7	Temporary stop	Refer to [(22) Temporary stop input]
8	Silent mode	Outdoor unit silent mode is activated.

(i) In case of "Level input" setting (Factory default)

Input signal to CnT-6 or CnTA is OFF→ON unit ON

Input signal to CnT-6 or CnTA is ON→OFF unit OFF

Operation is not inverted.

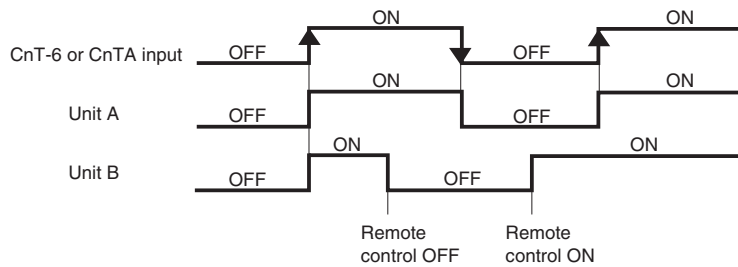

Note (1) The latest operation has priority

It is available to operate/stop by remote control or central control

(ii) In case of "Pulse input" setting (Local setting)

It is effective only when the input signal to CnT-6 or CnTA is changed OFF→ON, and at that time unit operation [ON/OFF] is inverted.

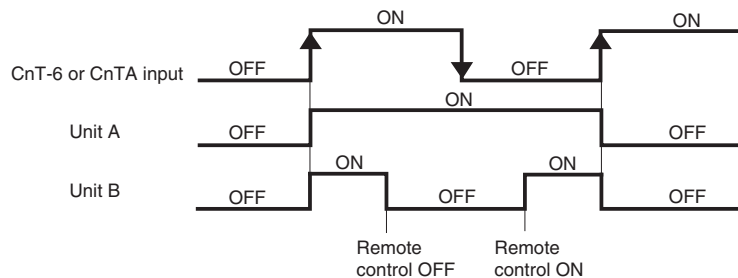

(c) Remote operation

(i) In case of multiple units (Max. 16 indoor units group) are connected to one wired remote control

When the R/C function setting of wired remote control for "External control set" is changed from "Individual (Factory default)" to "For all units", all units connected in one wired remote control system can be controlled by external operation input.

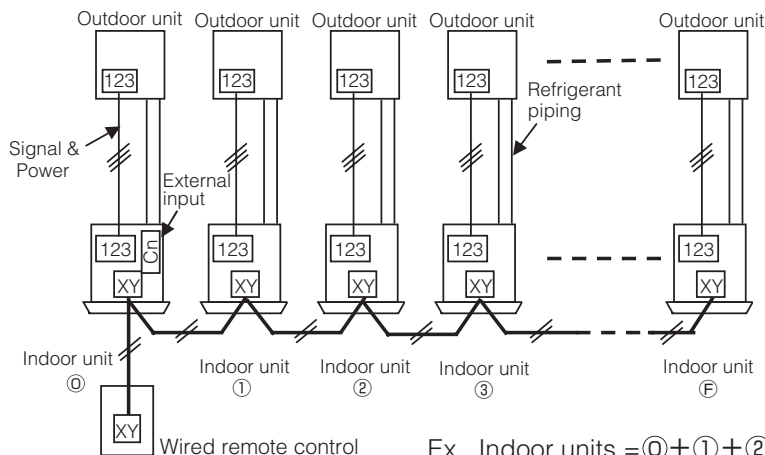

Ex. Indoor units = ① + ② + ③ + ⑤ ≤ 16 units

CnT-6 or CnTA	Individual operation (Factory default)		All units operation (Local setting)	
	ON	OFF	ON	OFF
	Only the unit directly connected to the remote control can be operated.	Only the unit directly connected to the remote control can be stopped operation.	All units in one remote control system can be operated.	All units in one remote control system can be stopped operation.
	Unit ① only	Unit ① only	Units ① – ⑥	Units ① – ⑥

When more than one indoor unit (Max. 16 indoor units) are connected in one wired remote control system:

- (1) With the factory default, external input to CnT-6 or CnTA is effective for only the unit ①.
- (2) When setting “For all unit” (Local setting), all units in one remote control system can be controlled by external input to CnT-6 or CnTA on the indoor unit ①.
- (3) External input to CnT-6 or CnTA on the other indoor unit than the unit ① is not effective.

(21) Operation permission/prohibition

(In case of adopting card key switches or commercially available timers)

When the indoor function setting of wired remote control for “Operation permission/prohibition” is changed from “Invalid (Factory default)” to “Valid”, following control becomes effective.

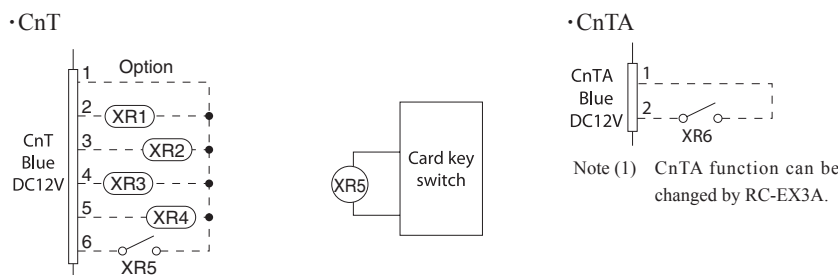

CnT-6 or CnTA	Normal operation (Factory default)		Operation permission/prohibition mode “Valid” (Local setting)	
	ON	OFF	ON	OFF
	Operation	Stop	Operation permission*1	Operation prohibition (Unit stops)

*1 **Only the “LEVEL INPUT” is acceptable for external input**, however when the indoor function setting of “Level input (Factory default)” or “Pulse input” is selected by the function for “External input” of the wired remote control, operation status will be changed as follows.

In case of “Level input” setting	In case of “Pulse input” setting
Unit operation from the wired remote control becomes available*(1)	Unit starts operation *(2)

* (1) In case that “Operation permission/prohibition mode” setting is “Valid” and “External input” setting is “Level input (Factory default)”;

- ① When card key switch is ON (CnT-6 or CnTA ON: Operation permission), start/stop operation of the unit from the wired remote control becomes available.
- ② When card key switch is OFF (CnT-6 or CnTA OFF: Operation prohibition), the unit stops operation in conjunction with OFF signal, and start/stop operation of the unit from the wired remote control becomes unavailable.

* (2) In case that “Operation permission/prohibition mode” setting is “Valid” and “External input” setting is “Pulse input (Local setting)”;

- ① When card key switch is ON (Operation permission), the unit starts operation in conjunction with ON signal, and also start/stop operation of the unit from the wired remote control becomes available.
- ② When card key switch is OFF (Operation prohibition), the unit stops operation in conjunction with OFF signal, and start/stop operation of the unit from the wired remote control becomes unavailable.

(3) This function is invalid only at “Center mode” setting done by central control.

(a) In case of CnT ① Operation stop level > CnTA ③ Operation permission/prohibition level

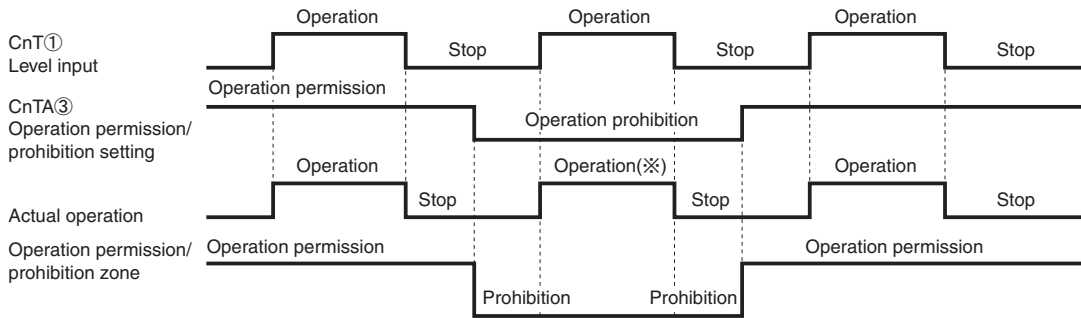

(※) CnT level input supersedes CnTA operation prohibition.

(b) In case of CnT ③ operation permission/prohibition level + CnTA ③ operation permission/prohibition level

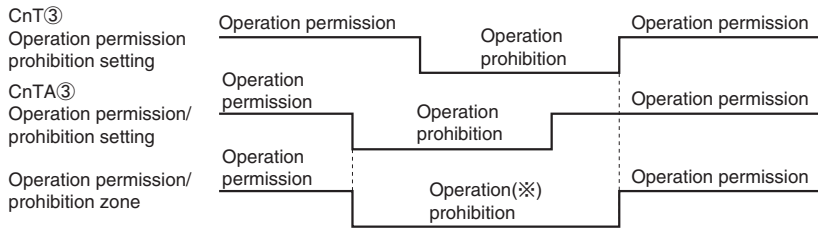

(※) Operation prohibition zone is determined by the OR judgment between CnT operation prohibition zone and CnTA operation prohibition zone.

(c) In case of CnT ③ operation permission/prohibition level > CnTA ② operation/stop pulse

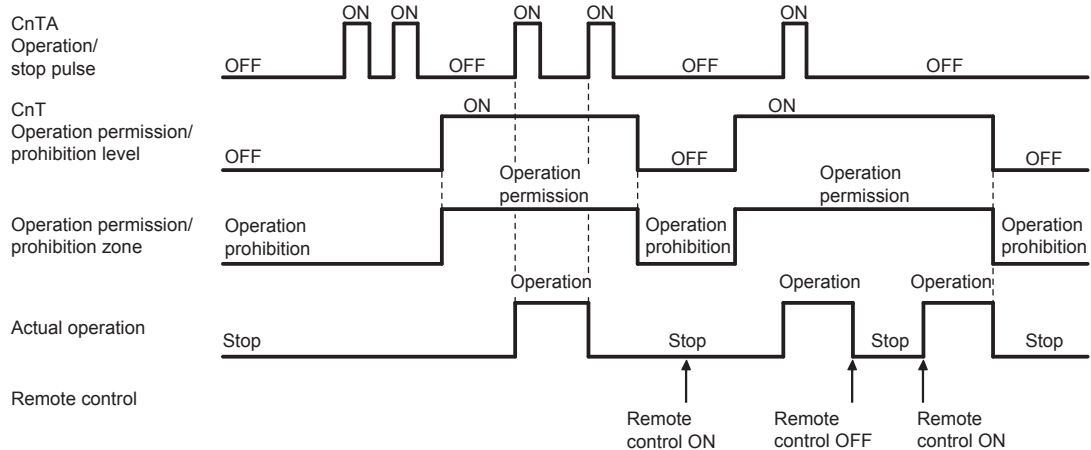

Note (1) If it is prohibited by CnT, all "Operation" and "Stop" commands are not accepted.

(d) In case of CnT ② operation/stop pulse + CnTA ③ operation permission/prohibition level

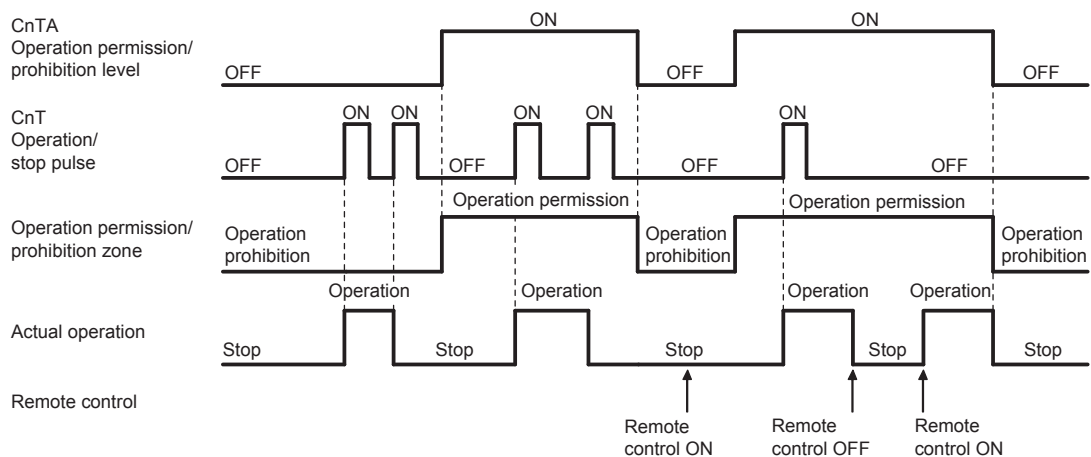

(22) Temporary stop input

In case of temporary stop, operation lamp of remote control lights, but indoor/outdoor unit stop the operation.

(a) In case of "level input" setting (Factory default)

Input signal to CnT-6 or CnTA is OFF → ON : Temporary stop
 Input signal to CnT-6 or CnTA is OFF → ON : Normal operation

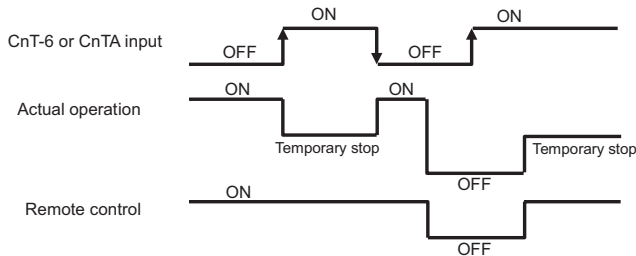

(b) In case of "pulse input" setting (Local setting)

It is effective only when the input signal is changed OFF→ON, and "temporary stop/normal operation" is inverted.

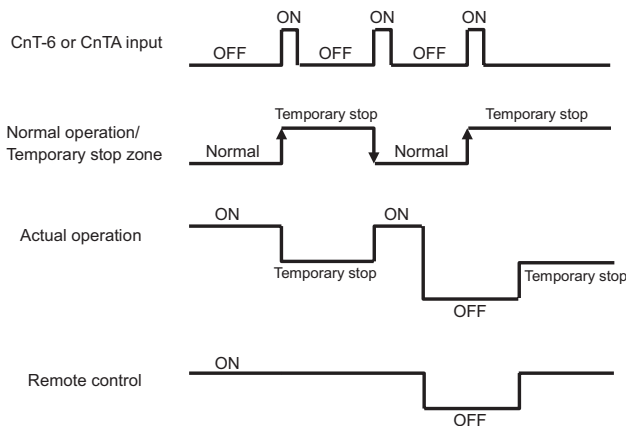

(23) Selection of cooling/heating external input function

- (a) When "External input 1 setting: Cooling/heating" is set by the indoor unit function from remote control, the cooling or heating is selected with CnT-6 or CnTA.
- (b) When the external input 1 method selection: Level input is set by the indoor unit function:
 - CnT-6 or CnTA: OPEN → Cooling operation mode
 - CnT-6 or CnTA: CLOSE → Heating operation mode
- (c) When the external input 1 method selection: Pulse input is set by the indoor unit function:
 - If the external input is changed OPEN → CLOSE, operation modes are inverted (Cooling → Heating or Heating → Cooling).
- (d) If the cooling/heating selection signal is given by the external input, the operation mode is transmitted to the remote control.

■ Selection of cooling/heating external input function

External input selection	External input method	Operation
External input selection Cooling/heating selection	⑤ Level	External terminal input (CnT or CnTA)
		Cooling/heating
	⑥ Pulse	External terminal input (CnT or CnTA)
		Cooling/heating
		Cooling/heating (Competitive)

Note (1) Regarding the priority order for combinations of CnT and CnTA, refer to Page 19.

(24) Fan control at heating startup

(a) Starting conditions

At the start of heating operation, if the difference of setting temperature and return air temperature is 5°C or higher after the end of hot start control, this control is performed.

(b) Contents of control

- (i) Sampling is made at each minute and, when the indoor heat exchanger temperature (detected with Thi-R) is 37°C or higher, present number of revolutions of indoor fan speed is increased by 10min⁻¹.
- (ii) If the indoor heat exchanger temperature drops below 37°C at next sampling, present number of revolutions of indoor fan speed is reduced by 10min⁻¹.

(c) Ending conditions

Indoor fan speed is reduced to the setting air flow volume when the compressor OFF is established and at 30 minutes after the start of heating operation.

(25) Room temperature detection temperature compensation during heating

With the standard specification, the compressor is turned ON/OFF with the thermostat setting temperature. When the thermostat is likely to turn OFF earlier because the unit is installed at the ceiling where warm air tends to accumulate, the setting can be changed with the wired remote control indoor unit function “~~SP~~ OFFSET”. The compressor and the heater are turned ON/OFF at one of the setting temperature +3, +2 or +1°C in order to improve the feeling of heating. The setting temperature, however, has the upper limit of 30°C.

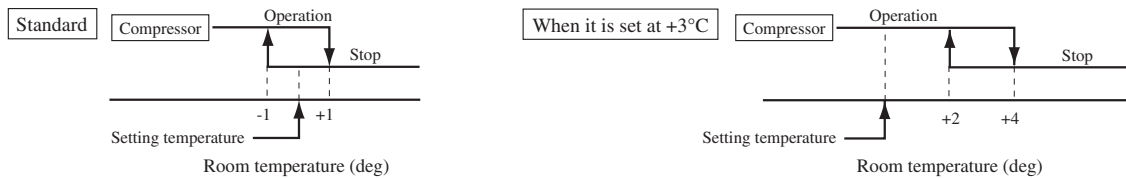

(26) Return air temperature compensation

This is the function to compensate the deviation between the detection temperature by the return air temperature sensor and the measured temperature after installing the unit.

- (a) It is adjustable in the unit of 0.5°C with the wired remote control indoor unit function “RETURN AIR TEMP”.
 - +1.0°C, +1.5°C, +2.0°C
 - -1.0°C, -1.5°C, -2.0°C
- (b) Compensated temperature is transmitted to the remote control and the compressor to control them.

Note (1) The detection temperature compensation is effective on the indoor unit thermistor only.

(27) High power operation (RC-EX3A only)

It operates at with the set temperature fixed at 16°C for cooling, 30°C for heating and maximum indoor fan speed for 15 minutes maximum.

(28) Energy-saving operation (RC-EX3A only)

It operates with the setting temperature fixed at 28°C for cooling, 22°C for heating or 25°C for auto. When fan control in cooling/heating thermo-OFF setting is “Set fan speed”, fan speed during thermo-OFF is changed to “Low”. (Maximum capacity is restricted at 80%.)

(29) Warm-up control (RC-EX3A only)

Operation will be started 5 to 60 minutes before use according to the forecast made by the microcomputer which calculates when the operation should be started in order to warm up the indoor temperature near the setting temperature at the setting time of operation start.

(30) Home leave mode (RC-EX3A only)

When the unit is not used for a long period of time, the room temperature is maintained at a moderate level, avoiding extremely hot or cool temperature.

- (a) Cooling or heating is operated according to the outdoor temperature (factory setting 35°C for cooling, 0°C for heating) and the setting temperature. (factory setting 33°C for cooling, 10°C for heating)
- (b) Setting temperature and indoor fan speed can be set by RC-EX3A.

(31) Auto temperature setting (RC-EX3A only)

Setting temperature is adjusted automatically at the adequate temperature the center setting temperature is 24°C by correcting the outdoor air temperature.

(32) Fan circulator operation (RC-EX3A only)

When the fan is used for circulation, the unit is operated as follows depending on the setting with the remote control.

- (a) If the invalid is selected with the remote control, the fan is operated continuously during the fan operation. (normal fan mode)
- (b) If the valid is selected with the remote control, the fan is operated or stopped when on the difference of the remote control temperature sensor and the return air temperature sensor becomes bigger than 3°C.

(33) The operation judgment is executed every 5 minutes (RC-EX3A only)

Setting temperature T_s is changed according to outdoor temperature.

This control is valid with cooling and heating mode. (Not auto mode)

- (a) Operate 5 minutes forcedly.
- (b) Setting temperature is adjusted every 10 minutes.
 - (i) Cooling mode.
 $T_s = \text{outdoor temperature} - \text{offset value}$
 - (ii) Heating mode.
 $T_s = \text{outdoor temperature} + \text{offset value}$
- (c) If the return air temperature lower than 18°C in cooling or return air temperature becomes higher than 25°C in heating, unit goes thermostat OFF.

(34) Auto fan speed control (RC-EX3A only)

In order to reach the room temperature to the set temperature as quickly as possible, the air flow rate is increased when the set temperature of thermostat differs largely from the return air temperature. According to temperature difference between set temperature and return air temperature, indoor fan tap are controlled automatically.

- Auto 1: Changes the indoor fan tap within the range of Hi ↔ Me ↔ Lo.
- Auto 2: Changes the indoor fan tap within the range of P-Hi ↔ Hi ↔ Me ↔ Lo.

(35) Indoor unit overload alarm (RC-EX3A only)

If the following condition is satisfied at 30 minutes after starting operation, RC-EX3A shows maintenance code "M07" and the signal is transmitted to the external output (CnT-2-5).

- Cooling, Dry, Auto(Cooling) : Indoor air temperature = Set room temperature by remote control + Alarm temperature difference
 - Heating, Auto(Heating) : Indoor air temperature = Set room temperature by remote control - Alarm temperature difference
- Alarm temperature difference is selectable between 5 to 10°C.

If the following condition is satisfied or unit is stopped, the signal is disappeared.

- Cooling, Dry, Auto(Cooling) : Indoor air temperature = Set room temperature + Alarm temperature difference - 2°C
- Heating, Auto(Heating) : Indoor air temperature = Set room temperature - Alarm temperature difference + 2°C

(36) Peak-cut timer (RC-EX3A only)

Power consumption can be reduced by restricting the maximum capacity.

Set the [Start time], the [End time] and the capacity limit % (Peak-cut %).

- 4-operation patterns per day can be set at maximum.
- The setting time can be changed by 5-minutes interval.
- The selectable range of capacity limit % (Peak-cut %) is from 0% to 40-80% (20% interval).
- Holiday setting is available.

(37) Motion sensor control (RC-EX3A only)

The sensor determines the presence of people and the amount of activity, and the following controls are done by the motion sensor.

Following settings are necessary to activate motion sensor control.

- (a) Infrared (motion) sensor setting: Installation setting of remote control
The indoor unit which is set to “Enable” become valid.
- (b) Infrared (motion) sensor control: Energy-saving setting of remote control
The function which is set to “Enable” become valid.
- (i) Power saving / comfort control
The set temperature is adjusted according to the presence of people and their amount of activity detected by the infrared (motion) sensor.

MODE:AUTO/COOL/HEAT mode operation

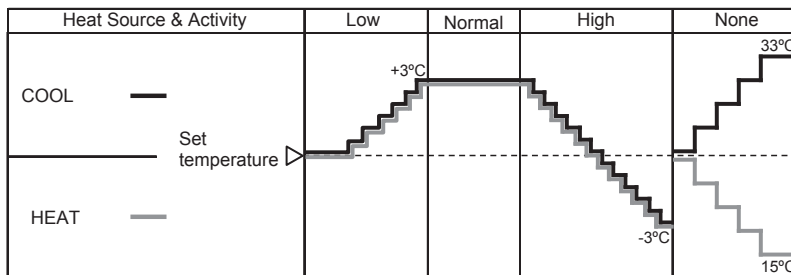

Low	When the extent of human activity is low
High	When the extent of human activity is high
None	When there is no one in the room

- When the “None” continues for 1 hour, the FAN SPEED is set Lo.

Notes (1) When the following operations are set, power saving control will be canceled.

- ① Energy-saving, Home leave mode, Warm-up control, Cooling operation check.
- ② When the operation mode is changed DRY or FAN.

(2) Not operable while the air-conditioner is OFF.

(ii) Auto-off control

When no activity is detected for 1 hour, unit will go stand-by mode.※ Unit will re-start operation automatically with the original set temperature by activity detection during the stand-by mode. When stand-by mode continues for 12 hours, unit stops.

※ Compressor keeps stopped regardless of the set temperature.

1.4 Operation control function by the outdoor control

(1) Defrost operation

(a) Starting conditions (Defrost operation can be started only when all of the following conditions are satisfied.)

- 1) After start heating operation
When it elapsed 35 minutes. (Total compressor operation time)
- 2) After finish of defrost operation
When it elapsed 35 minutes. (Total compressor operation time)
- 3) Outdoor heat exchanger temperature (TH1)
When the temperature has been -5°C or less for 3 minutes continuously.
- 4) The difference between the outdoor air temperature and the outdoor heat exchanger temperature is as following.

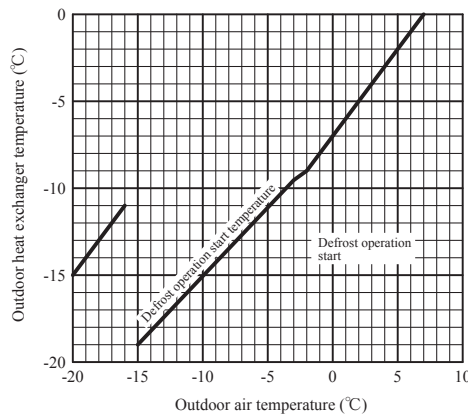

- 5) During continuous compressor operation
In case satisfied all of following conditions.
 - Connect compressor speed 0 rps 10 times or more.
 - Satisfy 1), 2) and 3) conditions above.
 - Outdoor air temperature is 3°C or less.

(b) Ending conditions (Operation returns to the heating cycle when either one of the following is satisfied.)

- 1) Outdoor heat exchanger temperature (TH1) : 10°C or higher
- 2) Continued operation time of defrost operation → For more than 18 minutes.

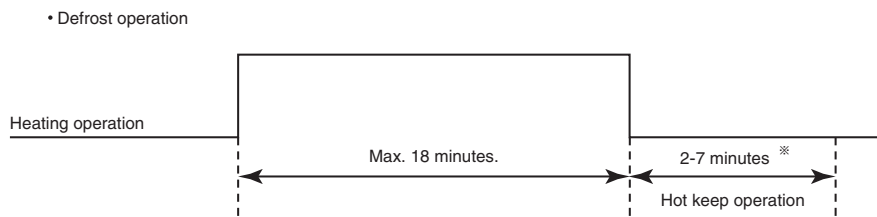

※Depends on an operation condition, the time can be longer than 7 minutes.

(2) Cooling overload protective control

(a) Operating conditions

When the outdoor air temperature (TH2) has become continuously for 30 seconds at 41°C or more, or 47°C or more with the compressor running, the lower limit speed of compressor is brought up.

Outdoor air temperature	41°C or more	47°C or more
Lower limit speed	30 rps	40 rps

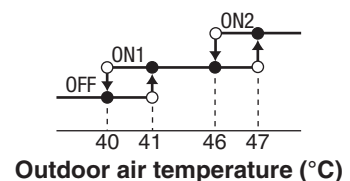

(b) Detail of operation

- 1) The outdoor fan is stepped up by 3 speed step. [Upper limit 8 th speed.]
- 2) The lower limit of compressor speed is set to 30 or 40 rps.
However, when the thermo OFF, the speed is reduced to 0 rps.

(c) Reset conditions

When either of the following condition is satisfied.

- 1) The outdoor air temperature is lower than 40°C.
- 2) The compressor speed is 0 rps.

(3) Cooling high pressure control

(a) Purpose

Prevents anomalous high pressure operation during cooling.

(b) Detector

Outdoor heat exchanger sensor (TH1).

(c) Detail of operation

(Example) Compressor speed

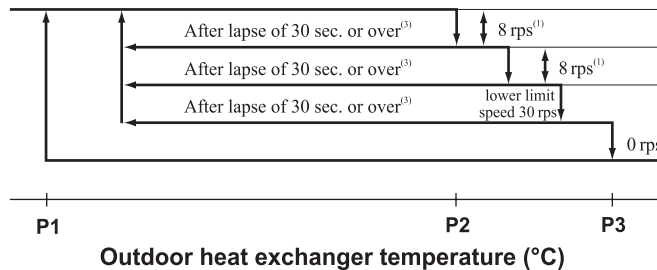

	TH1(°C)		
	P1	P2	P3
Range A	51	53	56
Range B	53	58	63

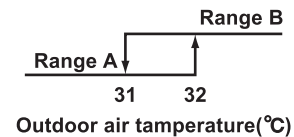

- Notes
- (1) When the outdoor heat exchanger temperature is in the range of P2-P3°C, the speed is reduced by 8 rps at each 20 seconds.
 - (2) When the temperature is P3°C or higher, the compressor is stopped.
 - (3) When the outdoor heat exchanger temperature is in the range of P1-P2°C, if the compressor speed is been maintained and the operation has continued for more than 20 seconds at the same speed, it returns to the normal cooling operation.

(4) Cooling low outdoor air temperature protective control

(a) Operating conditions

When the outdoor air temperature (TH2) is 22°C or lower continues for 20 seconds while the compressor speed is other than 0 rps.

(b) Detail of operation

- 1) It controls the upper and lower limit values for the compressor speed according to the following table.
- 2) It checks the outdoor temperature (TH2) once every hour to judge the operation range.

Compressor speed: Upper/lower limit (rps)				
Lower 1		Upper 1	Lower 2	Upper 2
Range B	Range A	75	45	60
35	Release			

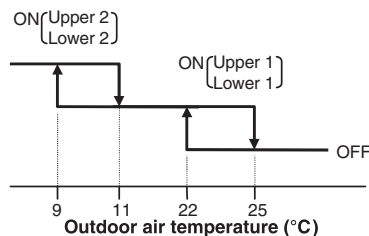
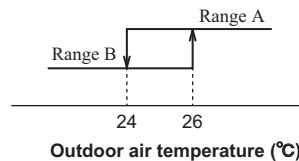

(c) Reset conditions

When either of the following condition is satisfied.

- 1) The outdoor air temperature (TH2) is D°C or higher.
- 2) The compressor speed is 0 rps.

(5) Heating high pressure control

(a) Starting condition

When the indoor heat exchanger temperature (Thi-R) has risen to a specified temperature while the compressor is turned on.

(b) Compressor speed is controlled according to the zones of indoor heat exchanger temperature as shown by the following table.

	Thi-R<P1	P1≤Thi-R<P2	P2≤Thi-R<P3	P3≤Thi-R
Protection control speed (NP)	Normal	Retention	NP-4rps	NP-8rps
Sampling time (s)	Normal	10	10	10

Unit:°C				
NP	Thi-R	P1	P2	P3
NP<50		45	52	54.5
50≤NP<115		45	52	57
115≤NP<120	45-43		52-50	57-55
120≤NP		43	50	55

(6) Heating overload protective control

(a) Operating condition

When the outdoor air temperature (TH2) is 13°C or higher continues for 30 seconds while the compressor speed is other than 0 rps.

(b) Detail of operation

- (i) Taking the upper limit of compressor speed range at 90(75) rps, if the output speed obtained with the fuzzy calculation exceeds the upper limit, the upper limit value is maintained.
- (ii) The lower limit of compressor speed is set to 30(40) rps and even if the calculated result lower than that after fuzzy calculation, the speed is kept to 30(40) rps. However, when the thermostat OFF, the speed is reduced to 0 rps.
- (iii) Inching prevention control is activated and inching prevention control is carried out with the minimum speed set at 40 rps.
- (iv) The outdoor fan speed is stepped down by 3 speed step.(Low limit 2nd speed)

(c) Reset condition

The outdoor air temperature (TH2) is lower than 11°C.

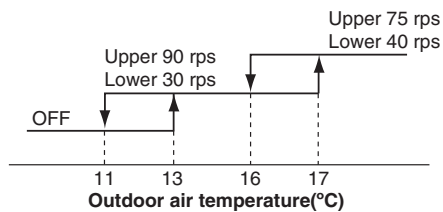

(7) Heating low outdoor temperature protective control

(a) Operating conditions

When the outdoor air temperature (TH2) is lower than 4°C or higher continues for 30 seconds while the compressor speed is other than 0 rps.

(b) Detail of operation

The lower limit compressor speed is change as shown in the figure below.

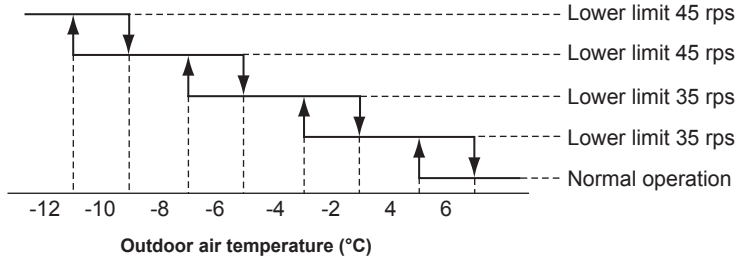

(c) Reset conditions

When either of the following condition is satisfied.

- 1) The outdoor air temperature (TH2) becomes 6 °C.
- 2) The compressor speed is 0 rps.

(8) Compressor overheat protection

(a) Purpose

It is designed to prevent deterioration of oil, burnout of motor coil and other trouble resulting from the compressor overheat.

(b) Detail of operation

- 1) Speeds are controlled with temperature detected by the sensor (TH3) mounted on the discharge pipe.

(Example) Fuzzy

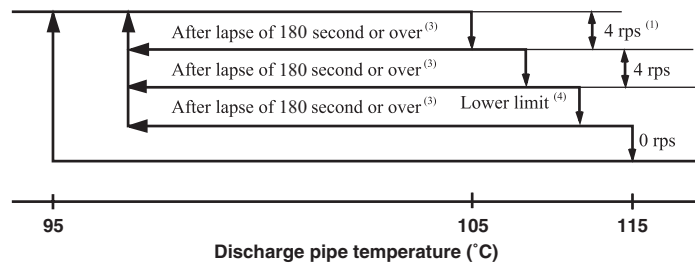

- Notes
- (1) When the discharge pipe temperature is in the range of 105-115°C, the speed is reduced by 4 rps.
 - (2) When the discharge pipe temperature is raised and continues operation for 20 seconds without changing, then the speed is reduced again by 4 rps.
 - (3) If the discharge pipe temperature is in the range of 95-105°C even when the compressor speed is maintained for 180 seconds when the temperature is in the range of 95-105°C, the speed is raised by 1 rps and kept at that speed for 180 seconds. This process is repeated until the com-mand speed is reached.
 - (4) Lower limit speed

	Cooling	Heating
Lower limit speed	25 rps	32 rps

- 2) If the temperature of 115°C is detected by the sensor on the discharge pipe, then the compressor will stop immediately. When the discharge pipe temperature drops and 3 minutes has elapsed the unit starts again within 1 hour but there is no start at the third time.

(9) Current safe

(a) Purpose

Current is controlled not to exceed the upper limit of the setting operation current.

(b) Detail of operation

Input current to the converter is monitored with the current sensor fixed on the printed circuit board of the outdoor unit and, if the operation current value reaches the limiting current value, the compressor speed is reduced.

If the mechanism is actuated when the compressor speed is less than 30 rps, the compressor is stopped immediately.

Operation starts again after 3 minutes.

(10) Current cut

(a) Purpose

Inverter is protected from overcurrent.

(b) Detail of operation

Output current from the inverter is monitored with a shunt resistor and, if the current exceeds the setting value, the compressor is stopped immediately. Operation starts again after 3 minutes.

(11) Outdoor unit failure

This is a function for determining when there is trouble with the outdoor unit during air-conditioning.

The compressor is stopped if any one of the following in item (i), (ii) is satisfied. Once the unit is stopped by this function, it is not restarted.

(i) When the input current is measured at 1 A or less for 3 continuous minutes or more.

(ii) If the outdoor unit sends a 0 rps signal to the indoor unit 3 times or more within 20 minutes of the power being turned on.

(12) Serial signal transmission error protection

(a) Purpose

Prevents malfunction resulting from error on the indoor ↔ outdoor signals.

(b) Detail of operation

If the compressor is operating and a serial signal cannot be received from the indoor control with outdoor control having serial signals continues for 7 minutes and 35 seconds, the compressor is stopped.

After the compressor has been stopped, it will be restarted after the compressor start delay if a serial signal can be received again from the indoor control.

(13) Rotor lock

If the motor for the compressor does not turn after it has been started, it is determined that a compressor lock has occurred and the compressor is stopped.

(14) Outdoor fan motor protection

If the outdoor fan motor has operated at 75 min⁻¹ or under for more than 30 seconds, the compressor and fan motor are stopped.

(15) Outdoor fan control at low outdoor temperature

(a) Cooling

1) Operating conditions

When the outdoor air temperature (TH2) is 22°C or lower continues for 30 seconds while the compressor speed is other than 0 rps.

2) Detail of operation

After the outdoor fan operates at A speed for 60 seconds; the corresponding outdoor heat exchanger temperature shall implement the following controls.

● Value of A

	Outdoor fan
Outdoor air temperature > 10°C	2nd speed
Outdoor air temperature ≤ 10°C	1st speed

- a) Outdoor heat exchanger temperature (TH1) $\leq 21^{\circ}\text{C}$
After the outdoor fan speed drops (down) to 1 speed for 60 seconds; if the outdoor heat exchanger temperature is lower than 21°C , gradually reduce the outdoor fan speed by 1 speed. (Lower limit 1st speed)
- b) $21^{\circ}\text{C} < \text{Outdoor heat exchanger temperature (TH1)} \leq 38^{\circ}\text{C}$
After the outdoor fan speed maintains at A speed for 20 seconds; if the outdoor heat exchanger temperature is $21^{\circ}\text{C} - 38^{\circ}\text{C}$, maintain outdoor fan speed.
- c) Outdoor heat exchanger temperature (TH1) $> 38^{\circ}\text{C}$
After the outdoor fan speed rises (up) to 1 speed for 60 seconds; if the outdoor heat exchanger temperature is higher than 38°C , gradually increase outdoor fan speed by 1 speed. (Upper limit 3rd speed)

3) Reset conditions

When either of the following conditions is satisfied.

- a) The outdoor air temperature (TH2) is 25°C or higher.
- b) The compressor speed is 0 rps.

(b) Heating

1) Operating conditions

When the outdoor air temperature (TH2) is 4°C or lower continues for 30 seconds while the compressor speed is other than 0 rps.

2) Detail of operation

The outdoor fan is stepped up by 2 speed step at each 20 seconds. (Upper limit 8th speed)

3) Reset conditions

When either of the following conditions is satisfied.

- a) The outdoor air temperature (TH2) is 6°C or higher.
- b) The compressor speed is 0 rps.

(16) Refrigeration cycle system protection

(a) Starting conditions

- 1) When A minutes have elapsed after the compressor ON or the completion of the defrost operation
- 2) Other than the defrost operation
- 3) When, after satisfying the conditions of 1) and 2) above, the compressor speed, indoor air temperature (Thi-A) and indoor heat exchanger temperature (Thi-R) have satisfied the conditions in the following table for 5 minutes:

Operation mode	A	Compressor speed (N)	Room temperature (Thi-A)	Room temperature (Thi-A)/ Indoor heat exchanger temperature (Thi-R)
Cooling	5	$40 \leq N$	$10 \leq \text{Thi-A} \leq 40$	$\text{Thi-A} - 4 < \text{Thi-R}$
Heating ⁽¹⁾	9	$40 \leq N$	$0 \leq \text{Thi-A} \leq 40$	$\text{Thi-R} < \text{Thi-A} + 4$

Note (1) Except that the fan speed is Hi in heating operation and silent mode control.

(b) Contents of control

- 1) When the conditions of (i) above are satisfied, the compressor stops.
- 2) Error stop occurs when the compressor has stopped 3 times within 60 minutes.

(c) Reset condition

When the compressor has been turned OFF.

2. MAINTENANCE DATA

2.1 Diagnosing of microcomputer circuit

(1) Selfdiagnosis function

(a) Check Indicator Table

Whether a failure exists or not on the indoor unit and outdoor unit can be know by the contents of remote control error code, indoor unit green LED (power pilot lamp and microcomputer normality pilot lamp) or red LED (check pilot lamp).

(i) Indoor unit

Remote control		Indoor control PCB		Location of trouble	Description of trouble	Repair method	Reference page
Error code	Red LED	Red LED	Green LED (1)				
No-indication	Stays OFF	Stays OFF	Keeps flashing	—	• Normal operation	—	—
		Stays OFF	Stays OFF	Indoor unit power source	• Power OFF, broken wire/blown fuse, broken transformer wire	Repair	53
		* 3-time flash	Keeps flashing	Remote control wires	• Poor connection, breakage of remote control wire * For wire breaking at power ON, the LED is OFF.	Repair	54
		Remote control	• Defective remote control PCB	Replacement of remote control			
WAIT or INSPECT I/U	Stays OFF	Keeps flashing	Indoor-outdoor units connection wire	• Poor connection, breakage of indoor-outdoor units connection wire	Repair	55-59	
			Remote control	• Improper setting of master and slave by remote control			
E1	Stays OFF	* Keeps flashing	Remote control wires (Noise)	• Poor connection of remote control signal wire (White) * For wire breaking at power ON, the LED is OFF	Repair	61	
			Remote control indoor control PCB	* Defective remote control or indoor control PCB (defective communication circuit)?			
E5	2-time flash	Keeps flashing	Indoor-outdoor units connection wire	• Poor connection of wire between indoor-outdoor units during operation (disconnection, loose connection)	Repair	62	
	2-time flash	Keeps flashing	(Noise)	• CPU-runaway on outdoor control PCB			
	2-time flash	Keeps flashing	Outdoor control PCB	* Occurrence of defective outdoor control PCB on the way of power source (defective communication circuit)?			Replacement of PCB
E6	1-time flash	Keeps flashing	Outdoor control PCB Fuse	• Defective outdoor control PCB on the way of power source	Replacement	63	
			Indoor heat exchanger temperature sensor	• Defective indoor heat exchanger temperature sensor (defective element, broken wire, short-circuit)			
E7	1-time flash	Keeps flashing	Indoor return air temperature sensor	• Poor contact of temperature sensor connector	Replacement, repair of temperature sensor	64	
			Indoor control PCB	* Defective indoor control PCB (Defective temperature sensor input circuit)?			
E8	1-time flash	Keeps flashing	Installation or operating condition	• Heating over-load (Anomalously high indoor heat exchanger temperature)	Repair	65	
			Indoor heat exchanger temperature sensor	• Defective indoor heat exchanger temperature sensor (short-circuit)			
			Indoor control PCB	* Defective indoor control PCB (Defective temperature sensor input circuit)?			
E9	1-time flash	Keeps flashing	Drain trouble	• Defective drain pump (DM), broken drain pump wire, disconnected connector	Replacement, repair of DM	66	
			Float switch	• Anomalous float switch operation (malfunction)			
			Indoor control PCB	* Defective indoor control PCB (Defective float switch input circuit)			
			Option	• Defective option parts (At option anomalous input setting)			
E10	Stays OFF	Keeps flashing	Number of connected indoor units	• When multi-unit control by remote control is performed, the number of units is over	Repair	67	
E11	Keeps flashing	Keeps flashing	Address setting error	• Address setting error of indoor units	Repair	68	
E16	1(2)-time flash	Keeps flashing	Fan motor	• Defective fan motor	Replacement, repair	69	
			Indoor power PCB	• Defective indoor power PCB			
E19	1-time flash	Keeps flashing	Indoor control PCB	• Improper operation mode setting	Repair	70	
E20	1(2)-time flash	Keeps flashing	Fan motor	• Indoor fan motor rotation speed anomaly	Replacement, repair	71	
			Indoor power PCB	• Defective indoor power PCB			
E21	1-time flash	Keeps flashing	Panel switch detection	• Defective panel switch operation	Repair	72	
E28	Stays OFF	Keeps flashing	Remote control temperature sensor	• Broken wire of remote control temperature sensor	Repair	73	

Note (1) Normal indicator lamp (Indoor unit: Green) extinguishes (or lights continuously) only when CPU is anomalous. It keeps flashing in any trouble other than anomalous CPU.

(2) * mark in the description of trouble means that, in ordinary diagnosis, it cannot identify the cause definitely, and, if the trouble is repaired by replacing the part, it is judged consequently that the replaced part was defective.

(ii) Outdoor unit

Remote control		Indoor control PCB		Location of trouble	Description of trouble	Repair method	Reference page
Error code	Red LED	Red LED	Green LED				
E35		Stays OFF	Keeps flashing	Installation, operation status	• Higher outdoor heat exchanger temperature	Repair	74
				Outdoor heat exchanger temperature sensor	• Defective outdoor heat exchanger temperature sensor	Replacement, repair of temperature sensor	
				Outdoor control PCB	*• Defective outdoor control PCB (Defective temperature sensor input circuit)?	Replacement of PCB	
E36		Stays OFF	Keeps flashing	Installation, operation status	• Higher discharge temperature	Repair	75
				Discharge pipe temperature sensor	• Defective discharge pipe temperature sensor	Replacement, repair of temperature sensor	
				Outdoor control PCB	*• Defective outdoor control PCB (Defective temperature sensor input circuit)?	Replacement of PCB	
E37		Stays OFF	Keeps flashing	Outdoor heat exchanger temperature sensor	• Defective outdoor heat exchanger temperature sensor, broken wire or poor connector connection	Replacement, repair of temperature sensor	76
				Outdoor control PCB	*• Defective outdoor control PCB (Defective temperature sensor input circuit)?	Replacement of PCB	
E38		Stays OFF	Keeps flashing	Outdoor air temperature sensor	• Defective outdoor air temperature sensor, broken wire or poor connector connection	Replacement, repair of temperature sensor	77
				Outdoor control PCB	*• Defective outdoor control PCB (Defective temperature sensor input circuit)?	Replacement of PCB	
E39	Keeps flashing	Stays OFF	Keeps flashing	Discharge pipe temperature sensor	• Defective discharge pipe temperature sensor, broken wire or poor connector connection	Replacement, repair of temperature sensor	78
				Outdoor control PCB	*• Defective outdoor control PCB (Defective temperature sensor input circuit)?	Replacement of PCB	
E40		Stays OFF	Keeps flashing	Installation, operation status	• Service valve (gas side) closing operation	Replacement	79
E42		Stays OFF	Keeps flashing	Outdoor control PCB, compressor	• Current cut (Anomalous compressor over-current)	Replacement of PCB	80•81
				Installation, operation status	• Service valve closing operation	Repair	
E47		Stays OFF	Keeps flashing	Outdoor control PCB	• Defective active filter	Repair PCB replacement	82
E48		Stays OFF	Keeps flashing	Fan motor	• Defective fan motor	Replacement	83
				Outdoor control PCB	• Defective outdoor control PCB		
E51		Stays OFF	Keeps flashing	Power transistor error (outdoor control PCB)	• Power transistor error	Replacement of PCB	84
E57		Stays OFF	Keeps flashing	Operation status	• Shortage in refrigerant quantity	Repair	85
				Installation status	• Service valve closing operation	Service valve opening check	
E58		Stays OFF	Keeps flashing	• Overload operation • Overcharge • Compressor locking	• Current safe stop	Replacement	86
E59		Stays OFF	Keeps flashing	Compressor, outdoor control PCB	• Anomalous compressor startup	Replacement	87
E60		Stays OFF	Keeps flashing	Compressor	• Anomalous compressor rotor lock	Replacement	88
⌚ WAIT or ⚠ INSPECT I/U		Stays OFF	Keep flashing	Indoor-outdoor connection wire	• Poor connection, breakage of indoor-outdoor unit connection wire	Repair	—

Note (1) * mark in the description of trouble means that, in ordinary diagnosis, it cannot identify the cause definitely, and, if the trouble is repaired by replacing the part, it is judged consequently that the replaced part was defective.

(iii) Option control in-use

Error code	Red LED	Indoor unit control PCB		Description of trouble	Repair method
		Red LED	Green LED		
E75	Keeps flashing	Stays OFF	Keeps flashing	• Communication error (Defective communication circuit on the main unit of SC-SL2NA-E or SC-SL4-AE/BE) etc.	Replacement

(iv) Display sequence of error codes or inspection indicator lamps

■ Occurrence of one kind of error

Displays are shown respectively according to errors.

■ Occurrence of plural kinds of error

Section	Category of display
Error code on remote control	• Displays the error of higher priority (When plural errors are persisting)
Red LED on indoor control PCB	• Displays the present errors. (When a new error has occurred after the former error was reset.)

E 1 > E 5 > > E 10 > E 32 > > E 60

■ Error detecting timing

Section	Error description	Error code	Error detecting timing
Indoor	Drain trouble (Float switch activated)	<i>E 9</i>	Whenever float switch is activated after 30 second had past since power ON.
	Communication error at initial operation	“ WAIT ”	No communication between indoor and outdoor units is established at initial operation.
	Remote control communication circuit error	<i>E 1</i>	Communication between indoor unit and remote control is interrupted for more than 2 minutes continuously after initial communication was established.
	Communication error during operation	<i>E 5</i>	Communication between indoor and outdoor units is interrupted for more than 2 minutes continuously after initial communication was established.
	Excessive number of connected indoor units by controlling with one remote control	<i>E 10</i>	Whenever excessively connected indoor units is detected after power ON.
	Return air temperature sensor anomaly	<i>E 7</i>	-50°C or lower is detected for 5 seconds continuously within 60 minutes after initial detection of this anomalous temperature.
Outdoor	Indoor heat exchanger temperature sensor anomaly	<i>E 6</i>	-50°C or lower is detected for 5 seconds continuously within 60 minutes after initial detection of this anomalous temperature. Or 70°C or higher is detected for 5 seconds continuously.
	Outdoor air temperature sensor anomaly	<i>E 38</i>	-55°C or lower is detected for 5 seconds continuously 3 times within 40 minutes after initial detection of this anomalous temperature. Or -55°C or lower is detected for 5 seconds continuously within 20 seconds after compressor ON.
	Outdoor heat exchanger temperature sensor anomaly	<i>E 37</i>	-55°C or lower is detected for 5 seconds continuously 3 times within 40 minutes after initial detection of this anomalous temperature. Or -55°C or lower is detected for 5 seconds continuously within 20 seconds after compressor ON.
	Discharge pipe temperature sensor anomaly	<i>E 39</i>	-25°C or lower is detected for 5 seconds continuously 3 times within 40 minutes after initial detection of this anomalous temperature.

■ **Error log and reset**

Error indicator	Memorized error log	Reset
Remote control display	• Higher priority error is memorized.	• Stop the unit by pressing the ON/OFF switch of remote control. • If the unit has recovered from anomaly, it can be operated.
Red LED on indoor control PCB	• Not memorized.	

■ **Resetting the error log**

- Resetting the memorized error log in the remote control
Holding down “CHECK” button, press “TIMER” button to reset the error log memorized in the remote control.
- Resetting the memorized error log in the indoor unit
The remote control transmits error log erase command to the indoor unit when “VENTI” button is pressed while holding down “CHECK” button.
Receiving the command, the indoor unit erase the log and answer the status of no error.

(2) **Troubleshooting procedure**

When any trouble has occurred, inspect as follows. Details of respective inspection method will be described on later pages.

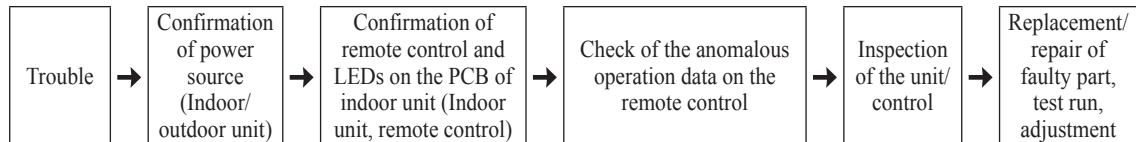

(3) **Troubleshooting at the indoor unit**

(a) **FDT series**

With the troubleshooting, find out any defective part by checking the voltage (AC, DC), resistance, etc. at respective connectors at around the indoor PCB, according to the inspection display or operation status of unit (the compressor does not run, fan does not run, the 4-way valve does not switch, etc.), and replace or repair in the unit of following part.

(i) **Replacement part related to indoor PCB's**

Control PCB, power source PCB, temperature thermistor (return air, indoor heat exchanger), remote control switch, limit switch, transformer and fuse

Note (1) With regard to parts of high voltage circuits and refrigeration cycle, judge it according to ordinary inspection methods.

(ii) **Instruction of how to replace indoor control PCB**

SAFETY PRECAUTIONS

- Read the "SAFETY PRECAUTIONS" carefully first of all and then strictly follow it during the replacement in order to protect yourself.
- The precautionary items mentioned below are distinguished into two levels, WARNING and CAUTION. Both mentions the important items to protect your health and safety so strictly follow them by any means.

⚠ WARNING	Wrong installation would cause serious consequences such as injuries or death.
⚠ CAUTION	Wrong installation might cause serious consequences depending on circumstances.

- After completing the replacement, do commissioning to confirm there are no anomaly.

⚠ WARNING

- Replacement should be performed by the specialist.
If you replace the PCB by yourself, it may lead to serious trouble such as electric shock or fire.
- Replace the PCB correctly according to these instructions.
Improper replacement may cause electric shock or fire.
- Shut off the power before electrical wiring work.
Replacement during the applying the current would cause the electric shock, unit failure or improper running.
It would cause the damage of connected equipment such as fan motor, etc.
- Fasten the wiring to the terminal securely, and hold the cable securely so as not to apply unexpected stress on the terminal.
Loose connections or hold could result in abnormal heat generation or fire.
- Check the connection of wiring to PCB correctly before turning on the power, after replacement.
Defectiveness of replacement may cause electric shock or fire.

⚠ CAUTION

- In connecting connector onto the PCB, connect not to deform the PCB. It may cause breakage or malfunction.
- Insert connector securely, and hook stopper. It may cause fire or improper running.
- Bundle the cables together so as not to be pinched or be tensioned. It may cause malfunction or electric shock for disconnection or deformation.

1) Model FDT series

a) Replace the control PCB

- i) Unscrew terminal (Arrow A) of the "E1" wiring (yellow/green) that is connected to PCB.
- ii) Replace the PCB only after all the wirings connected to the connector are removed.
- iii) Fix the board such that it will not pinch any of the wires.
- iv) Switch setting must be same setting as that of the removed PCB.
- v) Reconnect the all wirings to the PCB, that was removed in ii).
- vi) Rescrew the terminal (Arrow A) of the "E1" wiring, that was removed in i).
- vii) When there is no wire to connect to CNWR, connect the supplied jumper-connector. (Refer to Fig.2) If nothing is connected to CNWR, it doesn't work even when power is turned on.

b) Control PCB (※Parts mounting are different by the kind of PCB.)

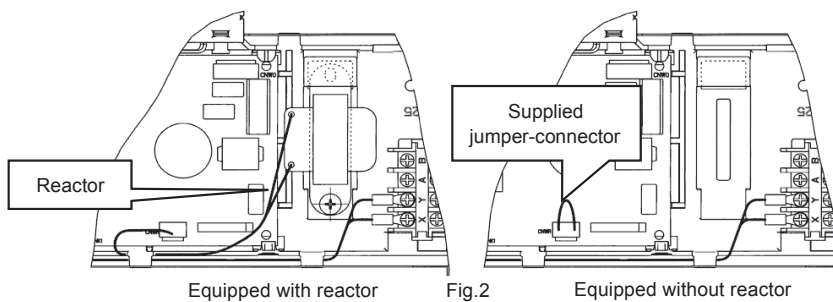
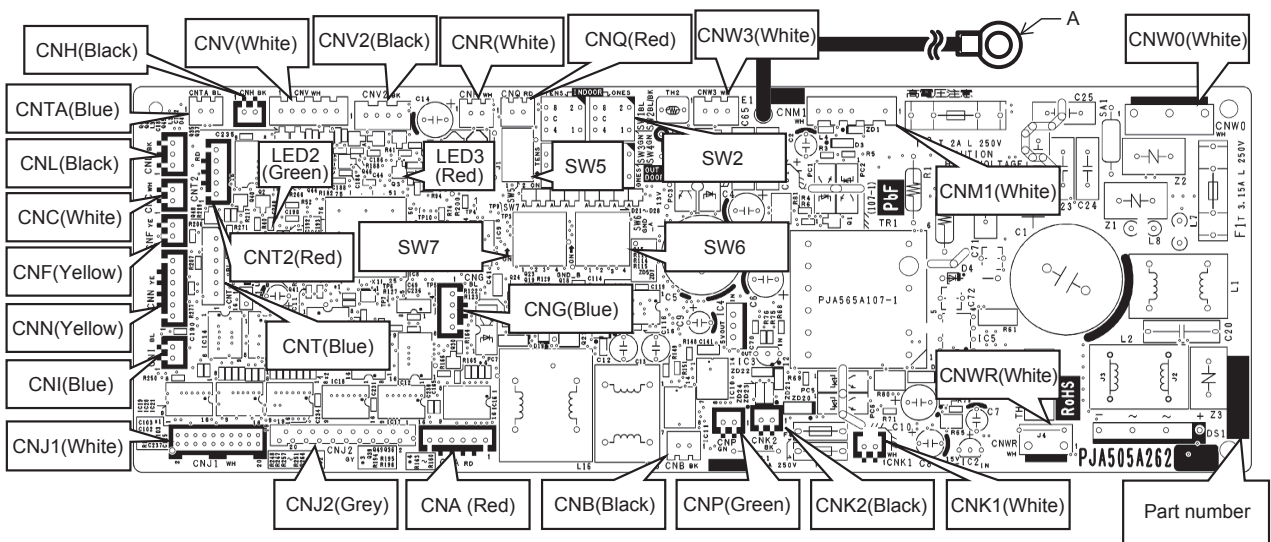

PSC012D050A

● **DIP switch setting list**

Switch	Description		Default setting		Remark
SW2	Address No. setting at plural indoor units control by 1 R/C		0		0-F
SW6-1	Model selection		As per model		See table 1.
SW6-2					
SW6-3					
SW6-4					
SW7-1	Test run, drain motor	Normal*/Test run	OFF	Normal	
SW7-2	Reserved		OFF		Keep OFF
SW7-3	Reserved		OFF		Keep OFF
SW7-4	Reserved		OFF		Keep OFF
JSL1	Superlink terminal spare	Normal*/switch to spare	With		

* Default setting

Table 1: Indoor unit model selection with SW6-1-SW6-4

Switch	40VH	50VH	60VH
SW6-1	ON	ON	ON
SW6-2	ON	OFF	ON
SW6-3	OFF	ON	ON
SW6-4	OFF	OFF	OFF

(4) Troubleshooting at the outdoor unit

When troubleshooting the outdoor unit, firstly assess the overview of malfunction and try to presume the cause and the faulty part by checking the error code displayed on the remote control and then proceed further inspection and remedy it.

Self-diagnosis system by microcomputer on indoor unit PCB can assist to find the cause of malfunction smoothly by making a diagnosis of not only the anomaly of microcomputer, but also the anomaly in power source system, installation space, overload resulting from improper charging amount of refrigerant and etc.

Unless the power is reset, the error log is saved in memory.

After automatical recovering from malfunction, if any another error mode which has a higher priority than the previous error saved in memory occurs, it is overwritten in memory and is displayed.

[Reset of power source]

Be sure to avoid electrical shock, when replacing or checking the outdoor unit control PCB, because some voltage is still retained in the electrolytic capacitor on the PCB even after shutting down the power source to the outdoor unit.

Be sure to start repairing work and reconfirming that voltage has been discharged sufficiently by measuring the voltage (DC) between both terminals of electrolytic capacitor (C58).

(Measurement of voltage may be disturbed by the moisture-proof coating. In such case, remove the coating and measure it by taking care of avoiding electrical shock.)

(a) Module of part to be replaced for outdoor unit control

Outdoor unit PCB, Temperature sensor (of outdoor heat exchanger, discharge pipe, outdoor air), Fuses (for power source and PCB) and Reactor.

(5) Check of anomalous operation data with the remote control

(a) In case of RC-EX3A remote control

[Operating procedure]

① On the TOP screen, touch the buttons in the order of “Menu” → “Service setting” → “Service & Maintenance” → “Service password” → “Set” → “Error display” → “Error history”.

② When only one indoor unit is connected to the remote control, followings will be displayed.

1) When there is any anomaly: “Loading. Wait a while” is displayed, followed by the operation data at the occurrence of anomaly. Contents of display

- Error code
- Number and data item

2) When there is no anomaly: “No anomaly” is displayed, and this mode is terminated.

③ When two or more indoor units are connected to the remote control, followings will be displayed.

1) When there is any anomaly: If the unit having anomaly is selected on the “Select IU” screen, “Loading. Wait a while” is displayed, followed by the operation data at the occurrence of anomaly.

Contents of display

- Indoor unit No.
- Error code
- Number and data item

2) When there is no anomaly: “No anomaly” is displayed, and this mode is terminated.

Note (1) When the number of connected units cannot be shown in a page, select “Next”.

④ If you press [RUN/STOP] button, the display returns to the TOP screen.

● **If you touch “Back” button on the way of setting, the display returns to the last precious screen.**

Note (1) When two remote controls are used to control indoor units, the check of anomaly operation data can be made on the master remote control only. (It cannot be operated from the slave remote control.)

■ Anomaly operation data (Corresponding data may not be provided depending on models. Such items will not be displayed.)

Number	Data Item
01	☼ (Operation Mode)
02	SET TEMP. ℃ (Set Temperature)
03	RETURN AIR. ℃ (Return Air Temperature)
04	SENSOR. ℃ (Remote Control Temperature)
05	THI-R1. ℃ (Indoor Heat Exchanger Temperature / U Bend)
06	THI-R2. ℃ (Indoor Heat Exchanger Temperature /Capillary)
07	THI-R3. ℃ (Indoor Heat Exchanger Temperature /Gas Header)
08	I/U FANSPEED (Indoor Unit Fan Speed)
09	DEMAND. Hz (Frequency Requirements)
10	ANSWER. Hz (Response Frequency)
11	I/U EEV. P (Pulse of Indoor Unit Expansion Value)
12	TOTAL I/URUN. H (Total Running Hours of The Indoor Unit)
13	SUPPLY AIR. ℃ (Supply Air Temperature)
21	OUTDOOR. ℃ (Outdoor Air Temperature)
22	THO-R1. ℃ (Outdoor Heat Exchanger Temperature)
23	THO-R2. ℃ (Outdoor Heat Exchanger Temperature)
24	COMP. Hz (Compressor Frequency)
25	HP. MPa (High Pressure)
26	LP. MPa (Low Pressure)
27	Td. ℃ (Discharge Pipe Temperature)
28	COMP BOTTOM. ℃ (Comp Bottom Temperature)
29	CT. AMP (Current)
30	TARGET SH. ℃ (Target Super Heat)
31	SH. ℃ (Super Heat)
32	TDSH. ℃ (Discharge Pipe Super Heat)
33	PROTECTION No. (Protection State No. of The Compressor)
34	O/U FANSPEED (Outdoor Unit Fan Speed)
35	63H1 (63H1 On/Off)
36	DEFROST (Defrost Control On/Off)
37	TOTAL COMP RUN. H (Total Running Hours of The Compressor)
38	O/U EEV1. P (Pulse of The Outdoor Unit Expansion Valve EEVC)
39	O/U EEV2. P (Pulse of The Outdoor Unit Expansion Valve EEVH)

● **Details of compressor protection status No. 33**

No.	Contents of display
"0"	Normal
"1"	Discharge pipe temperature protection control
"2"	Discharge pipe temperature anomaly
"3"	Current safe control of inverter primary current
"4"	High pressure protection control
"5"	High pressure anomaly
"6"	Low pressure protection control
"7"	Low pressure anomaly
"8"	Anti-frost prevention control
"9"	Current cut
"10"	Power transistor protection control
"11"	Power transistor anomaly (Overheat)
"12"	Compression ratio control
"13"	Spare
"14"	Dewing prevention control
"15"	Current safe control of inverter secondary current
"16"	Stop by compressor rotor lock
"17"	Stop by compressor startup failure
"18"	Active filter anomaly

Note(1) Operation data display on the remote control.
 • Data are displayed until canceling the protection control.
 • In case of multiple protections controlled, only the younger No. is displayed.
 Note(2) Common item.

- ① In heating mode.
 During protection control by the command signal for reducing compressor frequency from indoor unit, No. "4" is displayed.
- ② In cooling and dehumidifying mode.
 During protection control by the command signal for reducing compressor frequency from indoor unit, No. "8" is displayed.

(b) In case of RC-E5 remote control

Operation data can be checked with remote control unit operation.

- ① Press the **CHECK** button.
The display change “OPER DATA ▾”
- ② Press the **○** (SET) button while “OPER DATA ▾” is displayed.
- ③ When only one indoor unit is connected to remote control, “DATA LOADING” is displayed (blinking indication during data loading).
Next, operation data of the indoor unit will be displayed. Skip to step ⑦.
- ④ When plural indoor units is connected, the smallest address number of indoor unit among all connected indoor unit is displayed.
[Example]:
“SELECT I/U” (blinking 1 seconds) → “I/U000 ▲” blinking.
- ⑤ Select the indoor unit number you would like to have data displayed with the **▲** **▼** button.
- ⑥ Determine the indoor unit number with the **○** (SET) button.
(The indoor unit number changes from blinking indication to continuous indication)
“I/U000” (The address of selected indoor unit is blinking for 2 seconds.)
↓
“DATA LOADING” (A blinking indication appears while data loaded.) Next, the operation data of the indoor unit is indicated.

Number		Data Item
01	🌀	(Operation Mode)
02	SET TEMP °C	(Set Temperature)
03	RETURN AIR °C	(Return Air Temperature)
04	SENSOR °C	(Remote Control Temperature)
05	THI-R1 °C	(Indoor Heat Exchanger Temperature Sensor / U Bend)
06	THI-R2 °C	(Indoor Heat Exchanger Temperature Sensor / Capillary)
07	THI-R3 °C	(Indoor Heat Exchanger Temperature Sensor / Gas Header)
08	I/U FANSPEED	(Indoor Unit Fan Speed)
09	DEMAND Hz	(Frequency Requirements)
10	ANSWER Hz	(Response Frequency)
11	I/U EEV P	(Pulse of Indoor Unit Expansion Value)
12	TOTAL I/U RUN H	(Total Running Hours of The Indoor Unit)
21	OUTDOOR °C	(Outdoor Air Temperature)
22	THO-R1 °C	(Outdoor Heat Exchanger Temperature)
23	THO-R2 °C	(Outdoor Heat Exchanger Temperature)
24	COMP Hz	(Compressor Frequency)
25	HP MPa	(High Pressure)
26	LP MPa	(Low Pressure)
27	Td °C	(Discharge Pipe Temperature)
28	COMP BOTTOM °C	(Comp Bottom Temperature)
29	CT AMP	(Current)
30	TARGET SH °C	(Target Super Heat)
31	SH °C	(Super Heat)
32	TDSH °C	(Discharge Pipe Super Heat)
33	PROTECTION No. _	(Protection State No. of The Compressor)
34	O/U FANSPEED	(Outdoor Unit Fan Speed)
35	63H1	(63H1 On/Off)
36	DEFROST	(Defrost Control On/Off)
37	TOTAL COMP RUN H	(Total Running Hours of The Compressor)
38	O/U EEV1 P	(Pulse of The Outdoor Unit Expansion Valve EEV1)
39	O/U EEV2 P	(Pulse of The Outdoor Unit Expansion Valve EEV2)

- ⑦ Upon operation of the **▲** **▼** button, the current operation data is displayed in order from data number 01. The items displayed are in the above table.
*Depending on models, the items that do not have corresponding data are not displayed.
- ⑧ To display the data of a different indoor unit, press the **AIR CON No.** button, which allows you to go back to the indoor unit selection screen.
- ⑨ Pressing the **⓪ ON/OFF** button will stop displaying data.
Pressing the **⚡** (RESET) button during remote control unit operation will undo your last operation and allow you to go back to the previous screen.
⓪ If two (2) remote controls are connected to one (1) inside unit, only the master control is available for trial operation and confirmation of operation data. (The slave remote control is not available.)

● Details of compressor protection status No. 33

No.	Contents of display
"0"	Normal
"1"	Discharge pipe temperature protection control
"2"	Discharge pipe temperature anomaly
"3"	Current safe control of inverter primary current
"4"	High pressure protection control
"5"	High pressure anomaly
"6"	Low pressure protection control
"7"	Low pressure anomaly
"8"	Anti-frost prevention control
"9"	Current cut
"10"	Power transistor protection control
"11"	Power transistor anomaly (Overheat)
"12"	Compression ratio control
"13"	Spare
"14"	Dewing prevention control
"15"	Current safe control of inverter secondary current
"16"	Stop by compressor rotor lock
"17"	Stop by compressor startup failure
"18"	Active filter anomaly

- Note(1) Operation data display on the remote control.
• Data are displayed until canceling the protection control.
• In case of multiple protections controlled, only the younger No. is displayed.
- Note(2) Common item.
① In heating mode.
During protection control by the command signal for reducing compressor frequency from indoor unit, No. "4" is displayed.
② In cooling and dehumidifying mode.
During protection control by the command signal for reducing compressor frequency from indoor unit, No. "8" is displayed.

(6) Inverter checker for diagnosis of inverter output

● Checking method

- 1) Setup procedure of checker
 - a) Power OFF (Turn off the breaker).
 - b) Remove the terminal cover of compressor and disconnect the wires (U, V, W) from compressor.
 - c) Connect the wires U (Red), V (White) and W (Black) of the checker to the terminal of disconnected wires (U, V, W) from compressor respectively.
- 2) Operation for judgment
 - a) Power ON and start check operation on cooling or heating mode.
 - b) Check ON/OFF status of 6 LED's on the checker.
 - c) Judge the PCB by ON/OFF status of 6 LED's on the checker.

ON/OFF status of LED	If all of LED are ON/OFF according to following pattern	If all of LED stay OFF or some of LED are ON/OFF
Inverter PCB	Normal	Anomalous

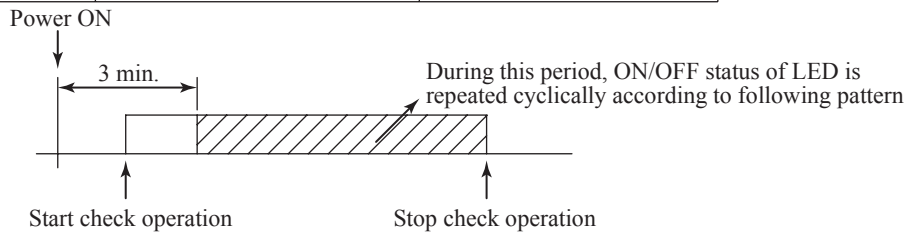

- d) Stop check operation within about 2 minutes after starting check operation.

〈Inverter checker〉

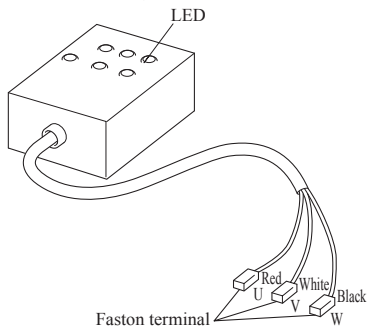

LED ON/OFF pattern

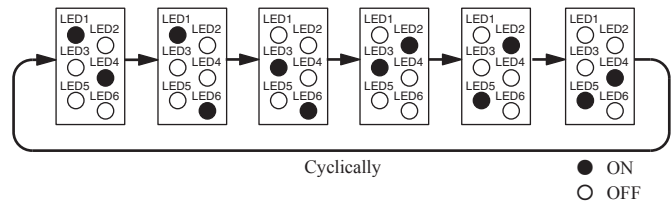

Connect to the terminal of the wires which are disconnected from compressor.

(7) Outdoor unit control failure diagnosis circuit diagram

Models SRC40ZSX-S, SRC50ZSX-S, 60ZSX-S

◆ Check point of outdoor unit

⚠ CAUTION – HIGH VOLTAGE
 High voltage is produced in the control box. Don't touch electrical parts in the control box for 5 minutes after the unit is stopped.

Color symbol

Mark	Color
BK	Black
BL	Blue
RD	Red
WH	White
YE	Yellow
Y/G	Yellow/Green

◆ Voltage check in PCB

The normal range is as follows.

Display	Voltage range
① DC280V DC230V -DC310V	
② DC 20V DC 18V -DC 22V	
③ DC 13V DC 12V -DC 14V	
④ DC 15V DC 14V -DC 16V	
⑤ DC 5V DC 4V -DC 6V	
⑥ DC 2.5V DC 2.3V -DC 2.5V	

◆ Inspection power transistor

Remove the faston terminal and test output voltage

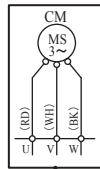

◆ Power source and serial signal inspection

- ① to ② : AC220/230/240V
- ① to ②/N : AC220/230/240V
- ②/N to ③ : Normal if the voltage oscillates between DC0 and approx. 20V

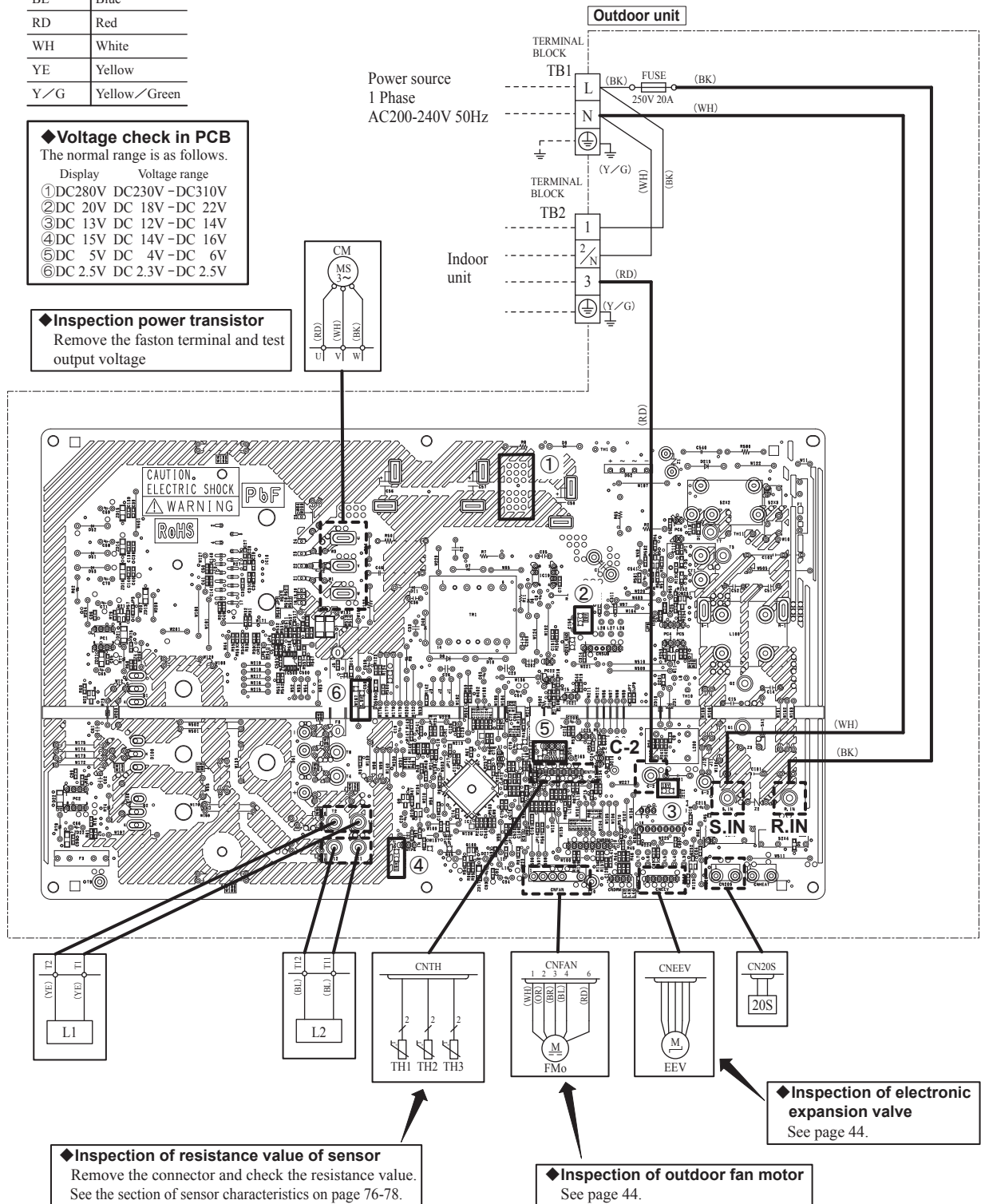

◆ Inspection of resistance value of sensor
 Remove the connector and check the resistance value. See the section of sensor characteristics on page 76-78.

◆ Inspection of outdoor fan motor
 See page 44.

(a) Inspection of electronic expansion valve

Electronic expansion valve operates for approx. 10 seconds after the power on, in order to determine its aperture. Check the operating sound and voltage during the period of time. (Voltage cannot be checked during operation in which only the aperture change occurs.)

- (i) If it is heard the sound of operating electronic expansion valve, it is almost normal.
- (ii) If the operating sound is not heard, check the output voltage.

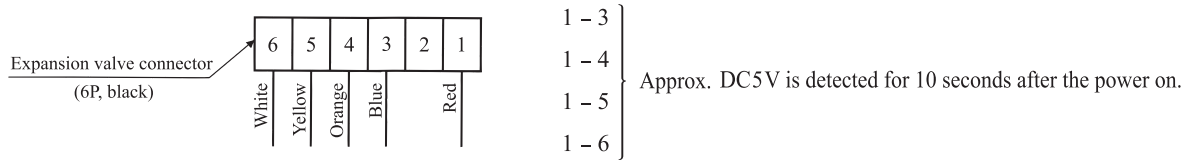

- (iii) If voltage is detected, the outdoor unit PCB is normal.
- (iv) If the expansion valve does not operate (no operating sound) while voltage is detected, the expansion valve is defective.

• Inspection of electronic expansion valve as a separate unit

Measure the resistance between terminals with an analog tester.

Measuring point	Resistance when normal
1-6	46 ± 4Ω (at 20°C)
1-5	
1-4	
1-3	

(b) Outdoor fan motor check procedure

- When the outdoor fan motor error is detected, diagnose which of the outdoor fan motor or outdoor unit PCB is defective.
- Diagnose this only after confirming that the indoor unit is normal.

(i) Outdoor PCB output check

- 1) Turn off the power.
- 2) Disconnect the outdoor fan motor connector CNFAN.
- 3) When the indoor unit is operated by inserting the power source plug and pressing (ON) the backup switch for more than 5 seconds, if the voltage of pin No. ② in the following figure is output for 30 seconds at 20 seconds after turning “ON” the backup switch, the outdoor unit PCB is normal but the fan motor is defective.

If the voltage is not detected, the outdoor unit PCB is defective but the fan motor is normal.

Note (1) The voltage is output 3 times repeatedly. If it is not detected, the indoor unit displays the error message.

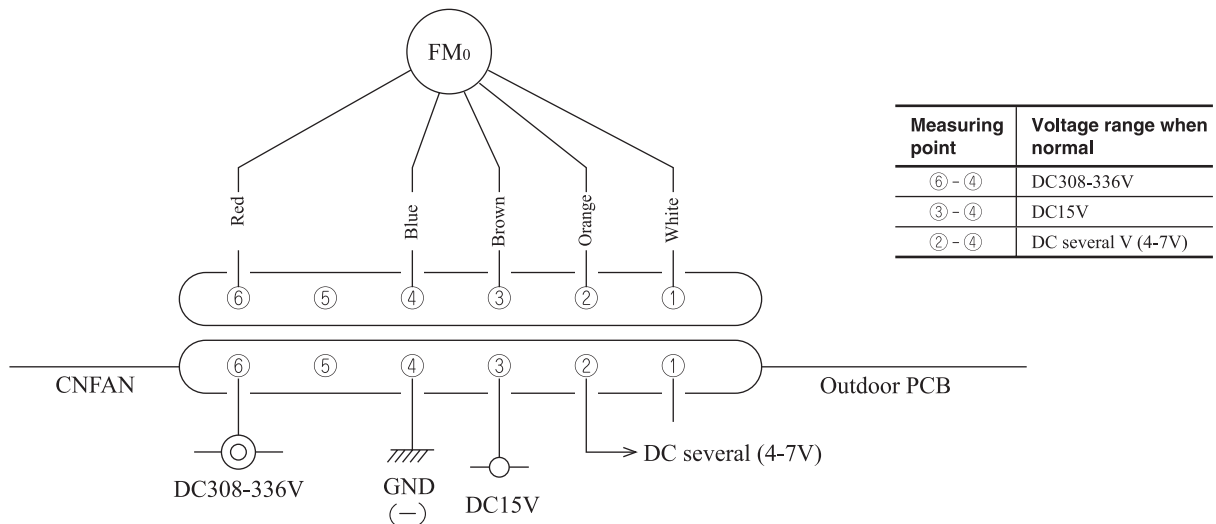



(ii) Fan motor resistance check

Measuring point	Resistance when normal
⑥ - ④ (Red - Blue)	20 MΩ or higher
③ - ④ (Brown - Blue)	20 kΩ or higher

- Notes (1) Remove the fan motor and measure it without power connected to it.
- (2) If the measured value is below the value when the motor is normal, it means that the fan motor is faulty.

2.2 Troubleshooting flow

(1) List of troubles

Remote control display	Description of trouble	Reference page
None	Operates but does not cool.	46
None	Operates but does not heat.	47
None	Earth leakage breaker activated	48
None	Excessive noise/vibration (1/3)	49
None	Excessive noise/vibration (2/3)	50
None	Excessive noise/vibration (3/3)	51
None	Louver motor failure	52
None	Power source system error (Power source to indoor unit control PCB)	53
None	Power source system error (Power source to remote control)	54
INSPECT I/U	INSPECT I/U (When 1 or 2 remote controls are connected)	55
INSPECT I/U	INSPECT I/U (Connection of 3 units or more remote controls)	56
 WAIT 	Communication error at initial operation	57 – 59
None	No display	60
E1	Remote control communication circuit error	61
E5	Communication error during operation	62
E6	Indoor heat exchanger temperature sensor anomaly	63
E7	Return air temperature sensor anomaly	64
E8	Heating overload operation	65
E9	Drain trouble	66
E10	Excessive number of connected indoor units (more than 17 units) by controlling with one remote control	67
E11	Address setting error of indoor units	68
E16	Indoor fan motor anomaly	69
E19	Indoor unit operation check, drain pump motor check setting error	70
E20	Indoor fan motor rotation speed anomaly	71
E21	Defective panel switch operation	72
E28	Remote control temperature sensor anomaly	73
E35	Cooling overload operation	74
E36	Discharge pipe temperature error	75
E37	Outdoor heat exchanger temperature sensor anomaly	76
E38	Outdoor air temperature sensor anomaly	77
E39	Discharge pipe temperature sensor anomaly	78
E40	Service valve (gas side) closing operation	79
E42	Current cut	80 • 81
E47	Active filter voltage error	82
E48	Outdoor fan motor anomaly	83
E51	Power transistor anomaly	84
E57	Insufficient refrigerant amount or detection of service valve closure	85
E58	Current safe stop	86
E59	Compressor startup failure	87
E60	Compressor rotor lock error	88

(2) Troubleshooting

Error code	LED	Green	Red	Content
Remote control: None	Indoor	Keeps flashing	Stays OFF	Operates but does not cool

1. Applicable model
All models
2. Error detection method
3. Condition of error displayed
4. Presumable cause
<ul style="list-style-type: none"> • Poor compression of compressor • Faulty expansion valve operation

5. Troubleshooting				
<table border="1"> <thead> <tr> <th>Diagnosis</th> <th>Countermeasure</th> </tr> </thead> <tbody> <tr> <td> <p>Check the indoor fan operation. Check the temperature difference between return and supply air.</p> <pre> graph TD Start[Check indoor fan operation and temperature difference] --> D1{Is the temperature difference between return and supply air 10-20°C at cooling?} D1 -- YES --> D2{Does the heat load increase after installation?} D1 -- NO --> D3{Is the compressor operating?} D2 -- YES --> Box1[Mistake in model selection. Calculate heat load once more.] D2 -- NO --> CM1[It is normal. (This unit is designed to start in the soft start mode by detecting the under dome temperature of compressor when it restart after power reset.)] Box1 --> CM2[It is necessary to replace to higher capacity one or to install additional unit.] D3 -- NO --> D4{"⌚ WAIT ⌚" message is displayed (for 3 seconds) when performing cooling, defrosting and heating operations from the remote control.} D3 -- YES --> D5{Is the compressor rotation speed low?} D4 -- YES --> CM3[Compressor refrigerant oil protection control at starting is activated. For the contents of control, refer to the compressor start control of the microcomputer control functions.] D4 -- NO --> CM4[Compressor may be stopped by the error detection control. For the contents of control, refer to anomalous stop control by controlling compressor rotation speed of microcomputer control functions.] D5 -- NO --> CM5[Inspect the followings. • Minor clogging of filter • Minor clogging of heat exchanger • Minor short-circuit • Minor shortage of refrigerant amount • Poor compression of compressor] D5 -- YES --> Box2[Check which control "Determination control of compressor rotation speed" or "Protective control by controlling compressor rotation speed" is appropriate to this phenomenon.] Box2 --> D6{Are the temperature conditions of room and outdoor air close to the rated conditions? (1)} D6 -- YES --> CM6[Considering appropriate operation control, check suspicious points. Inspect the followings for reference. • Major clogging of filter • Major clogging of heat exchanger • Major short-circuit • Major shortage of refrigerant amount • Compressor protection ON • Indoor fan tap • Valid setting of silent mode] D6 -- NO --> End[The unit is operating normally but is operating under the control for protecting compressor or other respective parts.] </pre> </td> <td> <p>It is normal. (This unit is designed to start in the soft start mode by detecting the under dome temperature of compressor when it restart after power reset.)</p> <p>It is necessary to replace to higher capacity one or to install additional unit.</p> <p>Compressor refrigerant oil protection control at starting is activated. For the contents of control, refer to the compressor start control of the microcomputer control functions.</p> <p>Compressor may be stopped by the error detection control. For the contents of control, refer to anomalous stop control by controlling compressor rotation speed of microcomputer control functions.</p> <p>Inspect the followings.</p> <ul style="list-style-type: none"> • Minor clogging of filter • Minor clogging of heat exchanger • Minor short-circuit • Minor shortage of refrigerant amount • Poor compression of compressor <p>Considering appropriate operation control, check suspicious points. Inspect the followings for reference.</p> <ul style="list-style-type: none"> • Major clogging of filter • Major clogging of heat exchanger • Major short-circuit • Major shortage of refrigerant amount • Compressor protection ON • Indoor fan tap • Valid setting of silent mode </td> </tr> </tbody> </table>	Diagnosis	Countermeasure	<p>Check the indoor fan operation. Check the temperature difference between return and supply air.</p> <pre> graph TD Start[Check indoor fan operation and temperature difference] --> D1{Is the temperature difference between return and supply air 10-20°C at cooling?} D1 -- YES --> D2{Does the heat load increase after installation?} D1 -- NO --> D3{Is the compressor operating?} D2 -- YES --> Box1[Mistake in model selection. Calculate heat load once more.] D2 -- NO --> CM1[It is normal. (This unit is designed to start in the soft start mode by detecting the under dome temperature of compressor when it restart after power reset.)] Box1 --> CM2[It is necessary to replace to higher capacity one or to install additional unit.] D3 -- NO --> D4{"⌚ WAIT ⌚" message is displayed (for 3 seconds) when performing cooling, defrosting and heating operations from the remote control.} D3 -- YES --> D5{Is the compressor rotation speed low?} D4 -- YES --> CM3[Compressor refrigerant oil protection control at starting is activated. For the contents of control, refer to the compressor start control of the microcomputer control functions.] D4 -- NO --> CM4[Compressor may be stopped by the error detection control. For the contents of control, refer to anomalous stop control by controlling compressor rotation speed of microcomputer control functions.] D5 -- NO --> CM5[Inspect the followings. • Minor clogging of filter • Minor clogging of heat exchanger • Minor short-circuit • Minor shortage of refrigerant amount • Poor compression of compressor] D5 -- YES --> Box2[Check which control "Determination control of compressor rotation speed" or "Protective control by controlling compressor rotation speed" is appropriate to this phenomenon.] Box2 --> D6{Are the temperature conditions of room and outdoor air close to the rated conditions? (1)} D6 -- YES --> CM6[Considering appropriate operation control, check suspicious points. Inspect the followings for reference. • Major clogging of filter • Major clogging of heat exchanger • Major short-circuit • Major shortage of refrigerant amount • Compressor protection ON • Indoor fan tap • Valid setting of silent mode] D6 -- NO --> End[The unit is operating normally but is operating under the control for protecting compressor or other respective parts.] </pre>	<p>It is normal. (This unit is designed to start in the soft start mode by detecting the under dome temperature of compressor when it restart after power reset.)</p> <p>It is necessary to replace to higher capacity one or to install additional unit.</p> <p>Compressor refrigerant oil protection control at starting is activated. For the contents of control, refer to the compressor start control of the microcomputer control functions.</p> <p>Compressor may be stopped by the error detection control. For the contents of control, refer to anomalous stop control by controlling compressor rotation speed of microcomputer control functions.</p> <p>Inspect the followings.</p> <ul style="list-style-type: none"> • Minor clogging of filter • Minor clogging of heat exchanger • Minor short-circuit • Minor shortage of refrigerant amount • Poor compression of compressor <p>Considering appropriate operation control, check suspicious points. Inspect the followings for reference.</p> <ul style="list-style-type: none"> • Major clogging of filter • Major clogging of heat exchanger • Major short-circuit • Major shortage of refrigerant amount • Compressor protection ON • Indoor fan tap • Valid setting of silent mode
Diagnosis	Countermeasure			
<p>Check the indoor fan operation. Check the temperature difference between return and supply air.</p> <pre> graph TD Start[Check indoor fan operation and temperature difference] --> D1{Is the temperature difference between return and supply air 10-20°C at cooling?} D1 -- YES --> D2{Does the heat load increase after installation?} D1 -- NO --> D3{Is the compressor operating?} D2 -- YES --> Box1[Mistake in model selection. Calculate heat load once more.] D2 -- NO --> CM1[It is normal. (This unit is designed to start in the soft start mode by detecting the under dome temperature of compressor when it restart after power reset.)] Box1 --> CM2[It is necessary to replace to higher capacity one or to install additional unit.] D3 -- NO --> D4{"⌚ WAIT ⌚" message is displayed (for 3 seconds) when performing cooling, defrosting and heating operations from the remote control.} D3 -- YES --> D5{Is the compressor rotation speed low?} D4 -- YES --> CM3[Compressor refrigerant oil protection control at starting is activated. For the contents of control, refer to the compressor start control of the microcomputer control functions.] D4 -- NO --> CM4[Compressor may be stopped by the error detection control. For the contents of control, refer to anomalous stop control by controlling compressor rotation speed of microcomputer control functions.] D5 -- NO --> CM5[Inspect the followings. • Minor clogging of filter • Minor clogging of heat exchanger • Minor short-circuit • Minor shortage of refrigerant amount • Poor compression of compressor] D5 -- YES --> Box2[Check which control "Determination control of compressor rotation speed" or "Protective control by controlling compressor rotation speed" is appropriate to this phenomenon.] Box2 --> D6{Are the temperature conditions of room and outdoor air close to the rated conditions? (1)} D6 -- YES --> CM6[Considering appropriate operation control, check suspicious points. Inspect the followings for reference. • Major clogging of filter • Major clogging of heat exchanger • Major short-circuit • Major shortage of refrigerant amount • Compressor protection ON • Indoor fan tap • Valid setting of silent mode] D6 -- NO --> End[The unit is operating normally but is operating under the control for protecting compressor or other respective parts.] </pre>	<p>It is normal. (This unit is designed to start in the soft start mode by detecting the under dome temperature of compressor when it restart after power reset.)</p> <p>It is necessary to replace to higher capacity one or to install additional unit.</p> <p>Compressor refrigerant oil protection control at starting is activated. For the contents of control, refer to the compressor start control of the microcomputer control functions.</p> <p>Compressor may be stopped by the error detection control. For the contents of control, refer to anomalous stop control by controlling compressor rotation speed of microcomputer control functions.</p> <p>Inspect the followings.</p> <ul style="list-style-type: none"> • Minor clogging of filter • Minor clogging of heat exchanger • Minor short-circuit • Minor shortage of refrigerant amount • Poor compression of compressor <p>Considering appropriate operation control, check suspicious points. Inspect the followings for reference.</p> <ul style="list-style-type: none"> • Major clogging of filter • Major clogging of heat exchanger • Major short-circuit • Major shortage of refrigerant amount • Compressor protection ON • Indoor fan tap • Valid setting of silent mode 			

Note:

Error code Remote control: None	LED	Green	Red	Content Operates but does not heat
	Indoor	Keeps flashing	Stays OFF	

1. Applicable model All models
2. Error detection method
3. Condition of error displayed
4. Presumable cause <ul style="list-style-type: none"> Faulty 4-way valve operation Poor compression of compressor Faulty expansion valve operation

5. Troubleshooting	
Diagnosis	Countermeasure
<p>Check the indoor fan operation. Check the temperature difference between return and supply air.</p> <pre> graph TD Start[Check indoor fan operation and temperature difference] --> D1{Is the temperature difference between return and supply air 10-30°C at heating?} D1 -- YES --> D2{Does the heat load increase after installation?} D1 -- NO --> D3{Is the compressor operating?} D2 -- YES --> B1[Mistake in model selection. Calculate heat load once again.] D2 -- NO --> C1[It is normal. This unit is designed to start in the soft start mode by detecting the under dome temperature of compressor when it restart after power reset.] D3 -- NO --> D4{"⌚ WAIT ⌚" message is displayed for 3 seconds when performing cooling, defrosting and heating operations from the remote control.} D3 -- YES --> D5{Is the compressor rotation speed low?} D4 -- YES --> C2[Compressor refrigerant oil protection control at starting is activated. For the contents of control, refer to the compressor start control of the microcomputer control functions.] D4 -- NO --> C3[Compressor may be stopped by the error detection control. For the contents of control, refer to anomalous stop control by controlling compressor rotation speed of microcomputer control functions.] D5 -- NO --> C4[Inspect the followings: Minor clogging of filter, Minor clogging of heat exchanger, Minor short-circuit, Minor shortage of refrigerant amount, Poor compression of compressor.] D5 -- YES --> B2[Check which control "Determination control of compressor rotation speed" or "Protective control by controlling compressor rotation speed" is appropriate to this phenomenon.] B2 --> D6{Are the temperature conditions of room and outdoor air close to the rated conditions? (1)} D6 -- YES --> C5[Considering appropriate operation control, check suspicious points. Inspect the followings for reference: Major clogging of filter, Major clogging of heat exchanger, Major short-circuit, Major shortage of refrigerant amount, Compressor protection ON, Indoor fan tap, Valid setting of silent mode.] D6 -- NO --> B3[The unit is operating normally but is operating under the control for protecting compressor or other respective parts.] Note[Note (1) Outdoor : 7°C, Indoor: 20°C] </pre>	<p>It is normal. (This unit is designed to start in the soft start mode by detecting the under dome temperature of compressor when it restart after power reset.)</p> <p>It is necessary to replace to higher capacity one or to install additional unit.</p> <p>Compressor refrigerant oil protection control at starting is activated. For the contents of control, refer to the compressor start control of the microcomputer control functions.</p> <p>Compressor may be stopped by the error detection control. For the contents of control, refer to anomalous stop control by controlling compressor rotation speed of microcomputer control functions.</p> <p>Inspect the followings. <ul style="list-style-type: none"> Minor clogging of filter Minor clogging of heat exchanger Minor short-circuit Minor shortage of refrigerant amount Poor compression of compressor </p> <p>Considering appropriate operation control, check suspicious points. Inspect the followings for reference. <ul style="list-style-type: none"> Major clogging of filter Major clogging of heat exchanger Major short-circuit Major shortage of refrigerant amount Compressor protection ON Indoor fan tap Valid setting of silent mode </p>

Note:

Error code Remote control: None	LED	Green	Red	Content Earth leakage breaker activated
	Indoor	Stays OFF	Stays OFF	

1. Applicable model
All models

2. Error detection method

3. Condition of error displayed

4. Presumable cause
<ul style="list-style-type: none"> • Defective compressor • Noise

5. Troubleshooting	
Diagnosis	Countermeasure
<pre> graph TD D1{Are OK the insulation resistance and coil resistance of compressor?} D2{Is insulation of respective harnesses OK? Is any harness bitten between pannel and casing or etc?} P1[Check the outdoor unit grounding wire/earth leakage breaker.] C1[Replace compressor.*] C2[Secure insulation resistance.] D1 -- NO --> C1 D1 -- YES --> D2 D2 -- NO --> C2 D2 -- YES --> P1 </pre>	
<p>Check of the outdoor unit grounding wire/earth leakage breaker</p> <p>① Run an independent grounding wire from the grounding screw of outdoor unit to the grounding terminal on the distribution panel. (Do not connect to another grounding wire.)</p> <p>② In order to prevent malfunction of the earth leakage breaker itself, confirm that it is conformed to higher harmonic regulation.</p> <p>* Insulation resistance of compressor</p> <ul style="list-style-type: none"> • Immediately after installation or when the unit has been left for long time without power source, the insulation resistance may drop to a few MΩ because of refrigerant migrated in the compressor. <p>When the earth breaker is activated at lower insulation resistance, check the following points.</p> <p>① When power ON, crankcase heater heat up compressor and evaporate the refrigerant migrated in the compressor.</p> <p>② Check if the earth leakage breaker is conformed to higher harmonic regulation or not.</p> <p>Since the unit is equipped with inverter, it is necessary to use components conformed to higher harmonic regulation in order to prevent malfunction of earth leakage breaker.</p>	

Note:

Error code Remote control: None	LED	Green	Red	Content Excessive noise/vibration (1/3)
	Indoor	-	-	

1. Applicable model
All models

2. Error detection method

3. Condition of error displayed

- 4. Presumable cause**
- ① Improper installation work
 - Improper anti-vibration work at installation
 - Insufficient strength of mounting face
 - ② Defective product
 - Before/after shipping from factory
 - ③ Improper adjustment during commissioning
 - Excess/shortage of refrigerant, etc.

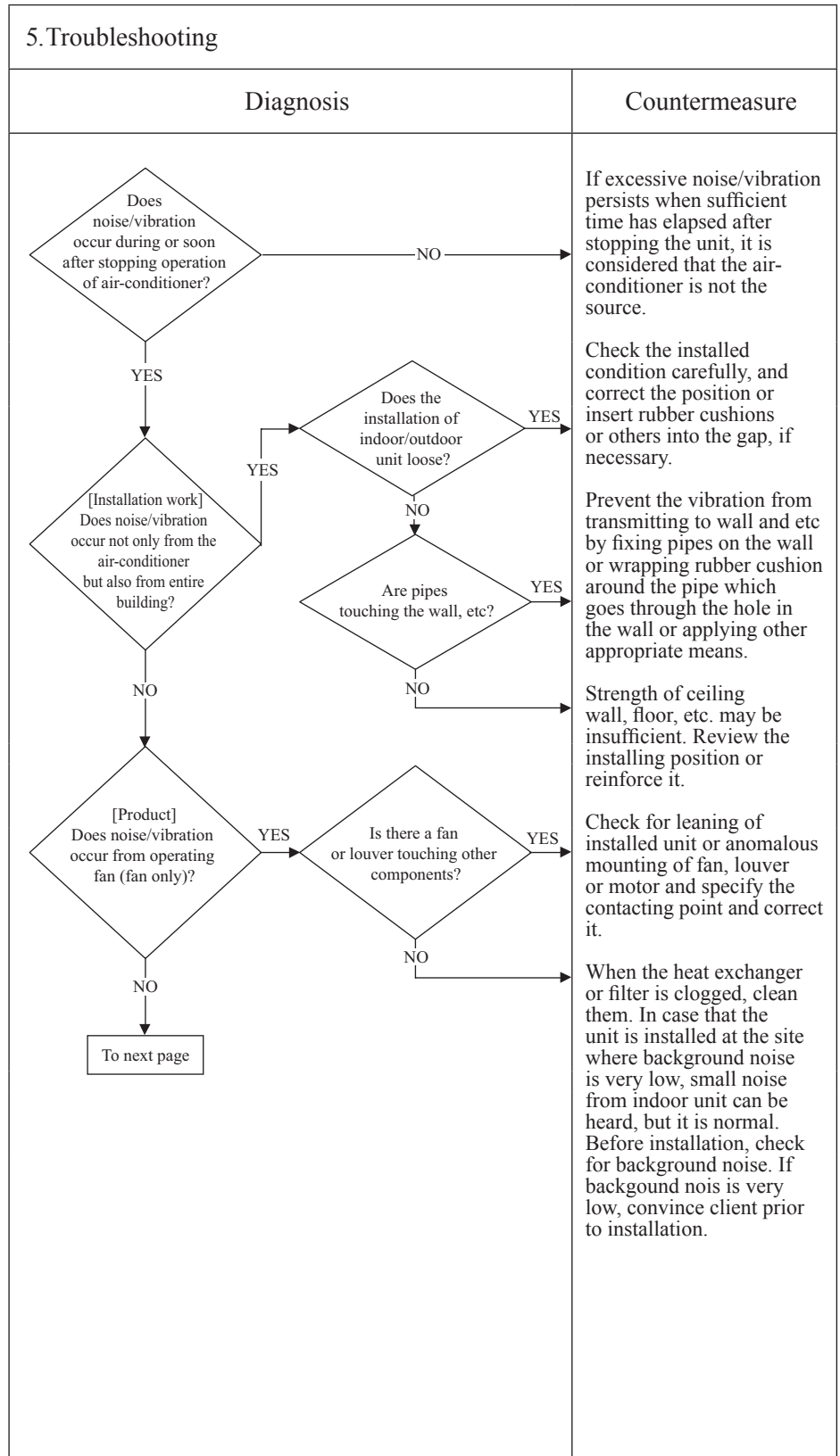

Note:

Error code Remote control: None	LED	Green	Red	Content Excessive noise/vibration (2/3)
	Indoor	-	-	

<p>1. Applicable model</p> <p>All models</p>	<p>5. Troubleshooting</p>	
<p>2. Error detection method</p>	<p style="text-align: center;">Diagnosis</p> <pre> graph TD Start([From previous page]) --> D1{[Unit side] Does noise/vibration occur when the cooling/heating operation is performed normally?} D1 -- NO --> NextPage[To next page] D1 -- YES --> D2{Are the pipes contacting the casing?} D2 -- YES --> CM1[Rearrange the piping to avoid contact with the casing.] D2 -- NO --> D3{Is it heard continuous hissing or roaring sound?} D3 -- YES --> CM2[It is noise/vibration that is generated when the refrigerant gas or liquid flow through inside of piping of air-conditioner. It is likely to occur particularly during cooling or defrost operation in the heating mode. It is normal.] D3 -- NO --> D4{Are hissing sounds heard at the startup or stopping?} D4 -- YES --> CM3[The noise/vibration occurs when the refrigerant starts or stops flowing. It is normal.] D4 -- NO --> D5{Is blowing sound heard at the start/stop of defrosting during heating?} D5 -- YES --> CM4[When the defrost operation starts or stops during heating, the refrigerant flow is reversed due to switching 4-way valve. This causes a large change in pressure which produces a blowing sound. It may accompany also the hissing sounds as mentioned above. They are normal.] D5 -- NO --> D6{Is cracking noise heard during heating operation?} D6 -- YES --> CM5[After the start or stop of heating operation or during defrost operation, abrupt changes in temperature cause resin parts to shrink or expand. This is normal.] D6 -- NO --> D7{Hissing noise is heard during cooling operation or after stopping?} D7 -- YES --> CM6[It is the sound produced by the drain pump that discharges drain from the indoor unit. The pump continues to run for 5 minutes after stopping the cooling operation. This is normal.] D7 -- NO --> CM7[Apply the damper sealant at places considered to be the sources such as the pressure reducing mechanism (expansion valve), capillary, etc.] </pre>	<p style="text-align: center;">Countermeasure</p>
<p>3. Condition of error displayed</p>	<p style="text-align: center;">Note:</p>	

Error code Remote control: None	LED	Green	Red	Content Excessive noise/vibration (3/3)
	Indoor	-	-	

<p>1. Applicable model</p> <p>All models</p>	5. Troubleshooting	
<p>2. Error detection method</p>	Diagnosis	Countermeasure
<p>3. Condition of error displayed</p>	<pre> graph TD A[From previous page] --> B{Adjustment during commissioning Does noise/vibration occur when the cooling/heating operation is in anomalous condition?} B -- YES --> C[Countermeasure] </pre>	
<p>4. Presumable cause</p>	<p>If insufficient cooling/heating problem happens due to anomalous operating conditions at cooling/heating, followings are suspicious.</p> <ul style="list-style-type: none"> • Overcharge of refrigerant • Insufficient charge of refrigerant • Intrusion of air, nitrogen, etc. <p>In such occasion, it is necessary to recover refrigerant, vacuum-dry and recharge refrigerant.</p> <p>* Since there could be many causes of noise/vibration, the above do not cover all. In such case, check the conditions when, where, how the noise/vibration occurs according to following check point.</p> <ul style="list-style-type: none"> • Indoor/outdoor unit • Cooling/heating/fan mode • Startup/stop/during operation • Operating condition (Indoor/outdoor temperatures, pressure) • Time it occurred • Operation data retained by the remote control such as compressor rotation speed, heat exchanger temperature, EEV opening degree, etc. • Tone (If available, record the noise) • Any other anomalies 	

Note:

Error code Remote control: None	LED	Green	Red	Content Louver motor failure
	Indoor	Keeps flashing	Stays OFF	

1. Applicable model
All models

2. Error detection method

3. Condition of error displayed

4. Presumable cause
<ul style="list-style-type: none"> • Defective LM • LM wire breakage • Faulty indoor unit control PCB

5. Troubleshooting	
Diagnosis	Countermeasure
<p>▲ Check at the indoor unit side.</p> <pre> graph TD Start[Operate after waiting for more than 1 minute.] --> Q1{Does the louver operate at the power on?} Q1 -- NO --> Q2{Is LM wiring broken?} Q2 -- YES --> C1[Repair wiring.] Q2 -- NO --> Q3{Is LM locked?} Q3 -- NO --> C2[Defective indoor unit control PCB → Replace.] Q3 -- YES --> C3[Replace LM.] Q1 -- YES --> Q4{Is the louver operable with the remote control?} Q4 -- YES --> C4[Normal.] Q4 -- NO --> C5[Adjust LM lever and then check again.] </pre> <p style="text-align: center;">LM: louver motor</p>	

Note:

Error code Remote control: None	LED	Green	Red	Content Power source system error (Power source to indoor unit control PCB)
	Indoor	Stays OFF	Stays OFF	

1. Applicable model
All models

2. Error detection method

3. Condition of error displayed

4. Presumable cause
<ul style="list-style-type: none"> • Misconnection or breakage of connecting wires • Blown fuse • Faulty transformer • Faulty indoor unit control PCB • Broken harness • Faulty outdoor unit control PCB (Noise filter)

5. Troubleshooting	
Diagnosis	Countermeasure
<pre> graph TD D1{Is AC220/240V detected between ① and ② on the terminal block of indoor unit?} D2{Are fuses OK (F1,2)} D3{Is DC5V detected between ④-⑤ of CNW2?} D4{Is JX1 open?} D5{Is AC380/415V for 3-phase unit detected between ①, ② and ③ on the terminal block of outdoor unit or is AC220/240V for 1-phase unit detected between ① and ② on the terminal block of outdoor unit?} D6{Is the check of resistance between ①-③ of CNW0 OK?} D7{Is the checked result of resistance of FM, LM, etc OK?} D1 -- YES --> D2 D1 -- NO --> D5 D2 -- YES --> D3 D2 -- NO --> D6 D3 -- YES --> D4 D3 -- NO --> C1[Defective indoor unit control PCB → Replace.] D4 -- YES --> C2[Defective indoor unit control PCB → Replace.] D4 -- NO --> C3[Open JX1.] D5 -- YES --> C4[Misconnection or breakage of connecting wires.] D5 -- NO --> C5[Defective outdoor unit control PCB (Noise filter).] D6 -- YES --> D7 D6 -- NO --> C6[Defective indoor unit control PCB → Replace.] D7 -- YES --> C7[Replace fuse.] D7 -- NO --> C8[Replace FM, LM, etc.] </pre>	<p>Defective outdoor unit control PCB (Noise filter).</p> <p>Misconnection or breakage of connecting wires.</p> <p>Defective indoor unit control PCB → Replace.</p> <p>Replace FM, LM, etc.</p> <p>Replace fuse.</p> <p>Defective indoor unit control PCB → Replace.</p> <p>Open JX1.</p> <p>Defective indoor unit control PCB → Replace.</p>

Note:

Error code Remote control: None	LED	Green	Red	Content Power source system error (Power source to remote control)
	Indoor	Keeps flashing	Stays OFF	

1. Applicable model
All models

2. Error detection method

3. Condition of error displayed

4. Presumable cause
<ul style="list-style-type: none"> • Remote control wire breakage/short-circuit • Defective remote control • Malfunction by noise • Broken harness • Faulty indoor unit control PCB

5. Troubleshooting	
Diagnosis	Countermeasure
<pre> graph TD D1{Is the connection of the remote control's wiring OK? X (white), Y (black)} -- NO --> C1[Correct.] D1 -- YES --> D2{Does the voltage between X and Y in the indoor terminal block exceed 15 VDC?} D2 -- NO --> C2[Remote control wire breakage? Replace remote control.] D2 -- YES --> P1[Power source reset] P1 --> D3{Does resetting the power source return it to normal?} D3 -- YES --> C3[Malfunction by temporary noise.] D3 -- NO --> D4{Does the re-measured voltage between X and Y in the indoor terminal block exceed 15 VDC?} D4 -- YES --> C4[Remote control wire breakage? Replace remote control.] D4 -- NO --> C5[Defective indoor unit control PCB -> Replace.] </pre>	

Note:

Error code Remote control: INSPECT I/U	LED	Green	Red	Content INSPECT I/U (When 1 or 2 remote controls are connected)
	Indoor	Keeps flashing	Stays OFF	

1. Applicable model
All models
2. Error detection method
Communication between indoor unit and remote control is disabled for more than 30 minutes after the power on.
3. Condition of error displayed
Same as above
4. Presumable cause
<ul style="list-style-type: none"> • Improper setting • Surrounding environment • Defective remote control communication circuit • Faulty indoor unit control PCB

5. Troubleshooting	
Diagnosis	Countermeasure
<pre> graph TD Q1{Are 2 units of remote control connected?} Q2{Does it become normal?} Q3{Is it set at the slave remote control?} Q4{Do more than one indoor units have the same address?} Q5{Are remote control wires laid along high voltage wires?} Q6{Does DM start 60 seconds later automatically.} Q1 -- YES --> S1[Set one remote control for "Master" and the other for "Slave"] S1 --> Q2 Q2 -- NO --> Q3 Q3 -- YES --> C1[Set SW1 on remote control PCB at "Master".] Q3 -- NO --> Q4 Q4 -- YES --> C2[Set address again. (SW2 on indoor unit control PCB)] Q4 -- NO --> Q5 Q5 -- YES --> C3[Separate remote control wires from high voltage wires.] Q5 -- NO --> S2[Disconnect the connecting wire ③ between the indoor and outdoor unit.] S2 --> S3[Power source reset] S3 --> Q6 Q6 -- YES --> C4[Defective indoor unit control PCB -> Replace.] Q6 -- NO --> C5[Defective remote control -> Change.] </pre>	

Note: If any error is detected 30 minutes after displaying “WAIT” on the remote control, the display changes to “INSPECT I/U”.

Error code Remote control: INSPECT I/U	LED	Green	Red	Content INSPECT I/U (Connection of 3 units or more remote controls)
	Indoor	Keeps flashing	Stays OFF	

1. Applicable model
All models
2. Error detection method
Indoor unit cannot communicate for more than 30 minutes after the power on with remote control.
3. Condition of error displayed
Same as above
4. Presumable cause
<ul style="list-style-type: none"> • Improper setting • Surrounding environment • Defective remote control communication circuit • Faulty indoor unit control PCB • Faulty outdoor unit control PCB

5. Troubleshooting	
Diagnosis	Countermeasure
<pre> graph TD Q1{Are more than 3 units of remote control connected?} -- YES --> C1[Reduce to 2 units or less.] Q1 -- NO --> Q2{Does remote control display "Slave"?} Q2 -- YES --> C2[Change remote control setting to "Master". (SW1 on remote control PCB)] Q2 -- NO --> Q3{Do more than one indoor units have the same address?} Q3 -- YES --> C3[Change address. (SW2 on indoor unit control PCB)] Q3 -- NO --> Q4{Is it set to a slave indoor unit. SW5-1, 2?} Q4 -- YES --> C4[Change to master. (SW5-1, 2 on indoor unit control PCB)] Q4 -- NO --> Q5{Is there loose or wrong connection at the terminal of wiring between indoor and outdoor units?} Q5 -- YES --> C5[Correct] Q5 -- NO --> Q6{Is the grounding wire connected properly?} Q6 -- YES --> Q7{Is approx. DC20V detected between ②-③ on the outdoor unit terminal block?} Q6 -- NO --> C6[Correct] Q7 -- NO --> C7[Defective outdoor unit control PCB → Replace.] Q7 -- YES --> Q8{Is approx. DC20V detected between ②-③ on the indoor unit terminal block?} Q8 -- NO --> C8[Broken connecting wire → Correct.] Q8 -- YES --> C9[Defective indoor unit control PCB → Replace.] </pre>	

Note: If any error is detected 30 minutes after displaying “WAIT” on the remote control, the display changes to “INSPECT I/U”.

Error code Remote control: 🏠WAIT🏠	LED	Green	Red	Content Communication error at initial operation (1/3)
	Indoor	Keeps flashing	Stays OFF	

1. Applicable model

All Models

When the remote control LCD displays “🏠WAIT🏠” 2 minutes after the power on.

2. Error detection method

3. Condition of error displayed

- 4. Presumable cause**
- Blown fuse
 - Faulty outdoor unit PCB
 - Connection between PCB's
 - Blown fuse on single phase model
 - Faulty indoor unit control PCB
 - Defective remote control
 - Broken remote control wire

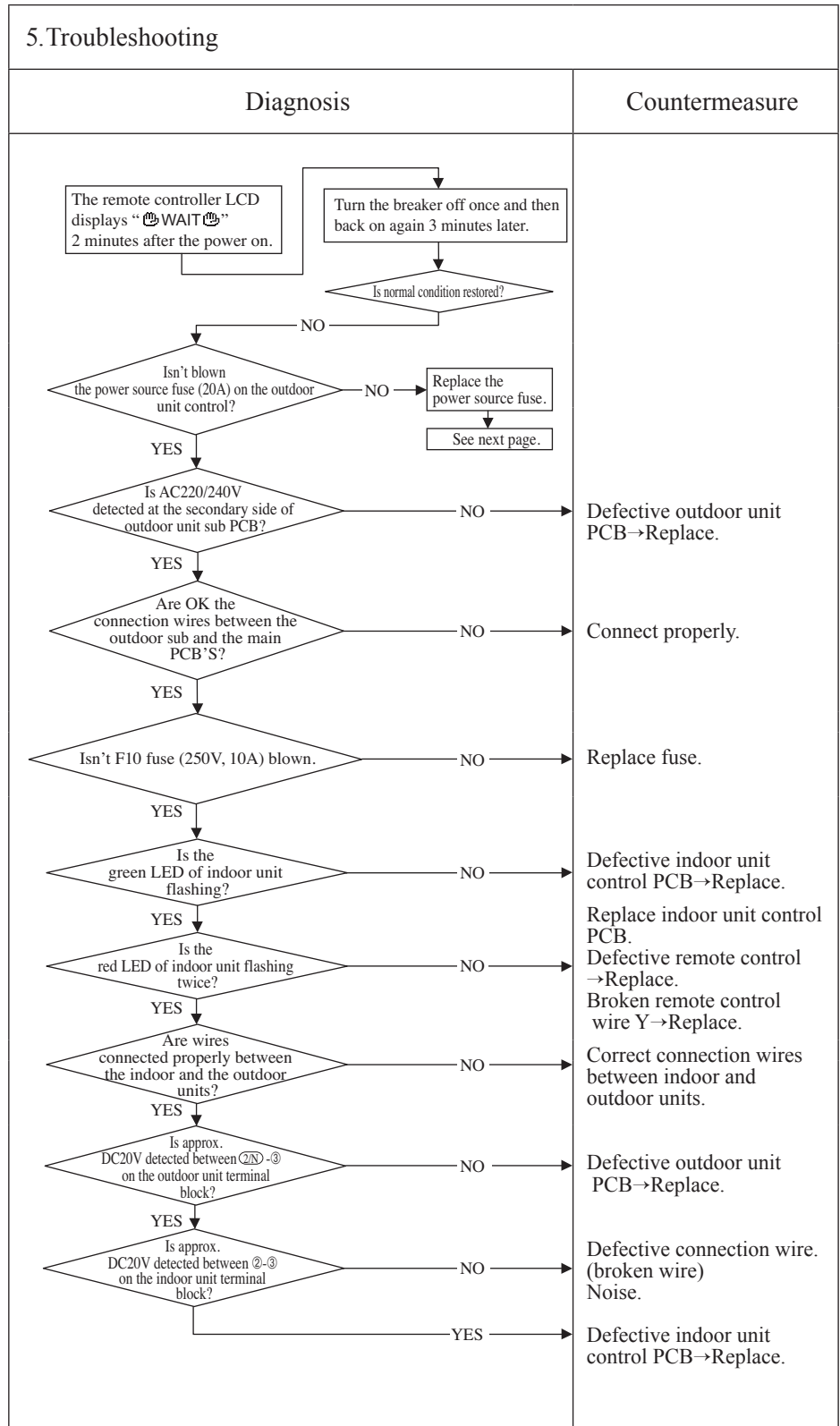

Note: If any anomaly is detected during communication, the error code E5 is displayed. (Outdoor unit red LED flashes twice.) Inspection procedure is same as above. (Excluding matters related to connection) When the power source is reset after the occurrence of E5, the LED will display “🏠WAIT🏠” if the anomaly continues. If the breaker ON/OFF is repeated in a short period of time (within 1 minute), “🏠WAIT🏠” may be displayed. In such occasion, turn the breaker off and wait for 3 minutes.

Error code Remote control: 🏠 WAIT 🏠	LED	Green	Red	Content Communication error at initial operation (2/3)
	Indoor	Keeps flashing	Stays OFF	

1. Applicable model
All Models
When the fuse is blown, the method to inspect inverter before replacing the power source fuse

2. Error detection method

3. Condition of error displayed

4. Presumable cause

- Blown fuse
- Faulty outdoor unit PCB
- Faulty reactor

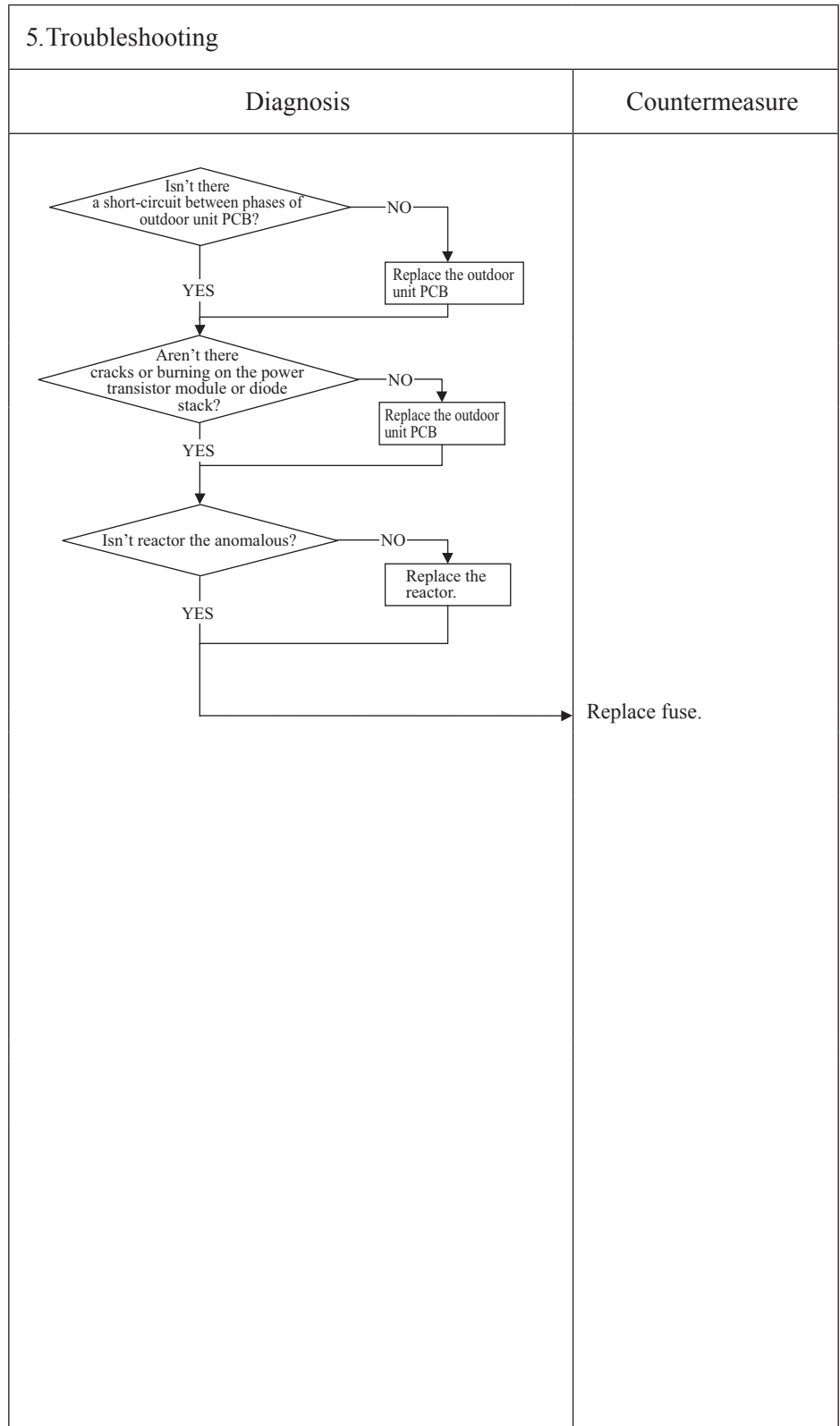

Note:

Error code Remote control: 🏠 WAIT 🏠	LED	Green	Red	Content Communication error at initial operation (3/3)
	Indoor	Keeps flashing	Stays OFF	

1. Applicable model
All Models
When the remote control display is extinguished after the power on.

2. Error detection method

3. Condition of error displayed

- 4. Presumable cause**
- Blown fuse
 - Connection between PCB's
 - Blown fuse
 - Faulty indoor unit control PCB
 - Defective remote control
 - Wire breakage on remote control
 - Faulty outdoor unit PCB

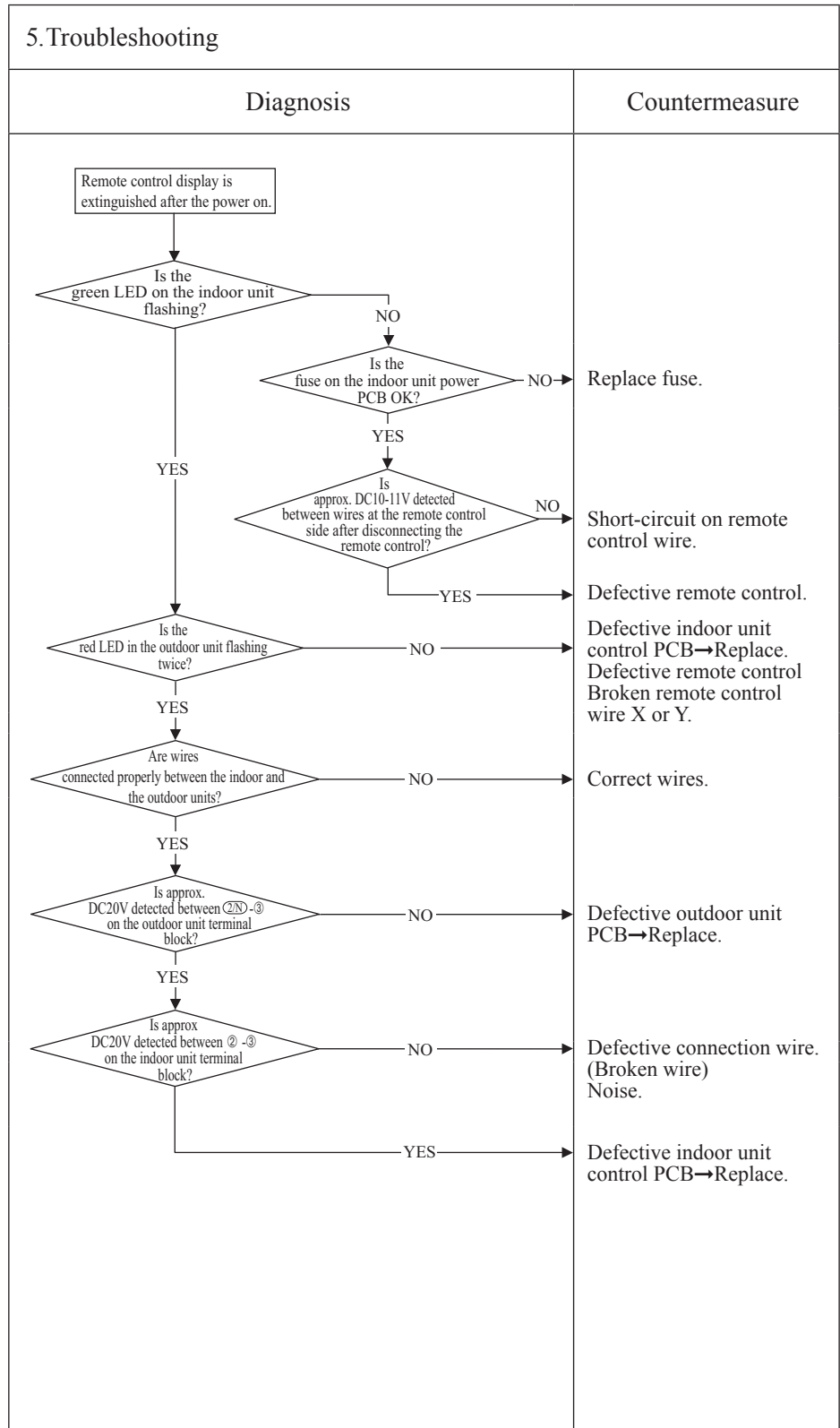

Note:

Error code Remote control: None	LED	Green	Red	Content No display
	Indoor	Stays OFF	Stays OFF	

1. Applicable model	5. Troubleshooting		
All models	Diagnosis	Countermeasure	
2. Error detection method	<pre> graph TD Start[Remote control does not display anything after the power on.] --> D1{Is DC10V or higher detected at remote control connection terminals?} D1 -- YES --> C1[Defective remote control.] D1 -- NO --> D2{Is DC10V or higher detected on remote control wires if the remote control is removed?} D2 -- YES --> C2[Defective remote control.] D2 -- NO --> D3{Are wires connected properly between the indoor/outdoor units?} D3 -- YES --> C3["Defective connecting wire. Defective remote control wire. (Short-circuit, etc.)"] D3 -- NO --> C4[Defective indoor unit control PCB -> Replace.] </pre>		
3. Condition of error displayed			
4. Presumable cause	<ul style="list-style-type: none"> • Faulty indoor unit control PCB • Defective remote control • Broken remote control wire 		

Note:

Error code Remote control: E1	LED	Green	Red	Content
	Indoor	Keeps flashing	Stays OFF	

Remote control communication circuit error

1. Applicable model
All models
2. Error detection method
When normal communication between the remote control and the indoor unit is interrupted for more than 2 minutes. (Detectable only with the remote control)
3. Condition of error displayed
Same as above
4. Presumable cause
<ul style="list-style-type: none"> • Defective communication circuit between remote control-indoor unit • Noise • Defective remote control • Faulty indoor unit control PCB

5. Troubleshooting	
Diagnosis	Countermeasure
<pre> graph TD A{Is it possible to reset normally by the power reset?} -- YES --> B[Malfunction by noise Check peripheral environment.] A -- NO --> C[Turn SW7-1 to OFF. → ON Remove the wire ③ connecting between indoor/outdoor units.] C --> D[Power source reset] D --> E{Does the drain pump restart automatically 1 minute later?} E -- YES --> F[Defective indoor unit control PCB → Replace.] E -- NO --> G[Connect the wire ③ connecting between indoor/outdoor units.] G --> H[Move to E5. (Communication error during operation) check.] </pre>	

Note: If the indoor unit cannot communicate normally with the remote control for 180 seconds, the indoor unit PCB starts to reset automatically.

Error code Remote control: E5	LED	Green	Red	Content Communication error during operation
	Indoor	Keeps flashing	2-time flash	

1. Applicable model
All models
2. Error detection method
When normal communication between indoor and outdoor unit is interrupted for more than 2 minutes.
3. Condition of error displayed
Same as above is detected during operation.
4. Presumable cause
<ul style="list-style-type: none"> • Unit No. setting error • Broken remote control wire • Faulty remote control wire connection • Faulty outdoor unit control PCB

5. Troubleshooting	
Diagnosis	Countermeasure
<p>● In case that the outdoor unit red LED flashes 2-time</p> <p>Note (1) Inspect faulty connections (disconnection, looseness) on the outdoor unit terminal block.</p> <p>Is the connection of signal wires at the outdoor unit side OK?</p> <p>NO → Repair signal wires.</p> <p>YES</p> <p>Note (2) Check for faulty connection or breakage of signal wires between indoor-outdoor units.</p> <p>Is the connection of signal wires between indoor-outdoor units OK?</p> <p>NO → Repair signal wires.</p> <p>YES</p> <p>Power source reset</p> <p>Has the remote control LCD returned to normal state?</p> <p>NO → To the diagnosis of “WAIT”.</p> <p>YES → Unit is normal. (Malfunction by temporary noise, etc.)</p> <p>● In case that the outdoor unit red LED stays OFF</p> <p>Power source reset</p> <p>NO</p> <p>Has the remote control LCD returned to normal state?</p> <p>NO → Defective outdoor unit PCB (Defective network communication circuit) → Replace.</p> <p>YES → Unit is normal. (Malfunction by temporary noise, etc.)</p>	

Note: Pressing the pump-down switch cancels communications between indoor and outdoor unit so that “communication error-E5” is displayed on indoor unit and remote control, but it is normal.

Error code Remote control: E6	LED	Green	Red	Content Indoor heat exchanger temperature sensor anomaly
	Indoor	Keeps flashing	1-time flash	

1. Applicable model
All models

2. Error detection method
Anomalously low temperature or high temperature (resistance) is detected on the indoor heat exchanger temperature sensor (Thi-R1, R2 or R3).

3. Condition of error displayed

- When the temperature sensor detects -50°C or lower for 5 seconds continuously, the compressor stops. After 3-minute delay, the compressor starts again automatically, but if this error occurs again within 60 minutes after the initial detection.
- Or if 70°C or higher is detected for 5 seconds continuously.

4. Presumable cause

- Defective indoor heat exchanger temperature sensor connector
- Indoor heat exchanger temperature sensor anomaly
- Faulty indoor unit control PCB

5. Troubleshooting

Diagnosis	Countermeasure
<p>Is the connection of indoor heat exchanger temperature sensor connector OK?</p> <p>NO →</p> <p>YES →</p> <p>Are characteristics of indoor heat exchanger temperature sensor OK?</p> <p>NO →</p> <p>YES →</p>	<p>Correct. → Insert connector securely.</p> <p>Defective indoor heat exchanger temperature sensor → Replace.</p> <p>Defective indoor unit control PCB → Replace. (Defective indoor heat exchanger temperature sensor input circuit)</p>
<p>(Broken wire) Temperature-resistance characteristic</p> <p>(Short-circuit)</p>	

Note:

Error code Remote control: E7	LED	Green	Red	Content Return air temperature sensor anomaly
	Indoor	Keeps flashing	1-time flash	

1. Applicable model
All models

2. Error detection method
Anomalously low temperature or high temperature (resistance) is detected by indoor return air temperature sensor (Thi-A)

3. Condition of error displayed

- When the temperature sensor detects -50°C or lower for 5 seconds continuously, the compressor stops. After 3-minute delay, the compressor starts again automatically, but if this error occurs again within 60 minutes after the initial detection.

4. Presumable cause

- Defective return air temperature sensor connector
- Defective return air temperature sensor
- Faulty indoor unit control PCB

5. Troubleshooting

Diagnosis	Countermeasure
<p>Is the connection of return air temperature sensor connector OK?</p> <p>NO →</p> <p>YES →</p> <p>Are the characteristics of return air temperature sensor OK?</p> <p>NO →</p> <p>YES →</p>	<p>Correct. → Connect connector.</p> <p>Defective return air temperature sensor → Replace.</p> <p>Defective indoor unit control PCB → Replace. (Defective return air temperature sensor input circuit)</p>

Temperature-resistance characteristic

Temperature (°C)	Temperature sensor resistance (kΩ)
0	15
10	10
20	7
25	5
30	4
40	3
50	2

Note:

Error code Remote control: E8	LED	Green	Red	Content Heating overload operation
	Indoor	Keeps flashing	1-time flash	

1. Applicable model
All models

2. Error detection method
Indoor heat exchanger temperature sensor (Thi-R1, R2, R3)

3. Condition of error displayed
When it is detected 5 times within 60 minutes from initial detection or when the overload condition is detected for 6 minutes continuously.

- 4. Presumable cause**
- Clogged air filter
 - Defective indoor heat exchanger temperature sensor connector
 - Defective indoor heat exchanger temperature sensor
 - Anomalous refrigerant system

5. Troubleshooting

Diagnosis	Countermeasure
<pre> graph TD Q1{Is the air filter clogged?} -- YES --> C1[Wash.] Q1 -- NO --> Q2{Is the indoor heat exchanger temperature sensor connection OK?} Q2 -- NO --> C2[Defective indoor heat exchanger temperature sensor connector → Correct.] Q2 -- YES --> Q3{Are the characteristics of indoor heat exchanger temperature sensor OK? (2)} Q3 -- NO --> C3[Defective indoor heat exchanger temperature sensor.] Q3 -- YES --> R1[Check the error data with the remote control.] R1 --> Q4{Is the unit operating in the state of heating overload?} Q4 -- NO --> C4[Check refrigerant system.] Q4 -- YES --> C5[Adjust.] </pre>	
<p>Note (1) Judge if it is in the state of overload or not as follows.</p> <ul style="list-style-type: none"> • Is there any short-circuit of air? • Isn't there any fouling or clogging on the indoor heat exchanger? • Is the outdoor fan control normal? • Isn't the room and outdoor air temperature too high? <p>Note (2) For characteristics of indoor heat exchanger temperature sensor, see the error display E6.</p> <p>The graph shows a horizontal line representing indoor heat exchanger temperature. A downward arrow labeled 'Reset' points to the line at 56°C. An upward arrow labeled 'Error stop' points to the line at 63°C.</p>	

Note: During heating operation; After starting compressor, compressor rotation speed is decreased by detecting indoor heat exchanger temperature (Thi-R) in order to control high pressure.

Error code Remote control: E9	LED	Green	Red	Content
	Indoor	Keeps flashing	1-time flash	

Drain trouble

1. Applicable model
All models
2. Error detection method
Float switch is activated
3. Condition of error displayed
If the float switch OPEN is detected for 3 seconds continuously or if float switch connector or wire is disconnected.
4. Presumable cause
<ul style="list-style-type: none"> • Defective indoor unit control PCB • Float switch setting error • Humidifier drain pump motor interlock setting error • Option equipment setting error • Drain piping error • Defective drain pump motor • Disconnection of drain pump motor wiring

5. Troubleshooting	
Diagnosis	Countermeasure
<pre> graph TD Start[Check the error data in the remote control.] --> Q1{Is there any overflow?} Q1 -- NO --> Q2{Is DC12V at CNI connector?} Q1 -- YES --> Q3{Is the humidifier connected?} Q2 -- YES --> C1[Check float switch.] Q2 -- NO --> Q4{Is the CNI connected firmly?} Q3 -- YES --> Q5{Is the humidifier drain pump motor interlocked by the indoor unit function setting of remote control?} Q3 -- NO --> C2[Correct setting to "Humidifier drain pump motor interlock".] Q4 -- NO --> C3[Defective indoor unit control PCB → Replace.] Q4 -- YES --> Q6{Is there any anomaly on the option equipment?} Q5 -- YES --> C4[Check option equipment.] Q5 -- NO --> C2 Q6 -- YES --> C4 Q6 -- NO --> C3 Q5 --> Act1[Drain pump motor ON from the remote control] Act1 --> Q7{Does drain pump motor operate?} Q7 -- NO --> Q8{Is DC12V detected at CNR connector?} Q7 -- YES --> Q9{Is the drain piping unclogged? Is the drain pipe slope OK?} Q8 -- YES --> C5[Check wiring of drain motor.] Q8 -- NO --> C6[Defective indoor unit control PCB → Replace.] Q9 -- YES --> C7[Check drain pump motor.] Q9 -- NO --> C8[Correct.] </pre>	

Note: When this error occurred at power ON, disconnection of wire or connector of the float switch is suspected. Check and correct it (or replace it, if necessary).

Error code Remote control: E10	LED	Green	Red	Content Excessive number of connected indoor units (more than 17 units) by controlling with one remote control
	Indoor	Keeps flashing	Stays OFF	

1. Applicable model	5. Troubleshooting	
All models	Diagnosis	Countermeasure
	<pre> graph LR A{Aren't more than 17 indoor units connected to one remote control?} -- NO --> B[Defective remote control -> Replace.] A -- YES --> C[Reduce to 16 or less units.] </pre>	
2. Error detection method		
When it detects more than 17 of indoor units connected to one remote control		
3. Condition of error displayed		
Same as above		
4. Presumable cause		
<ul style="list-style-type: none"> • Excessive number of indoor units connected • Defective remote control 		

Note:

Error code Remote control: E11	LED	Green	Red	Content Address setting error of indoor units
	Indoor	Keeps flashing	Keeps flashing	

1. Applicable model
All models

2. Error detection method
IU address has been set using the “Master IU address set” function of remote control.

3. Condition of error displayed
Same as above

4. Presumable cause
Same as above

5. Troubleshooting	
Diagnosis	Countermeasure
<pre> graph TD A[E11 occurs] --> B{Is "Master IU address set" function of remote control used?} B -- YES --> C[Countermeasure] </pre>	
<p>In case the wiring is below and “Mastar IU address set” is used, E11 is appeared.</p>	
	<ul style="list-style-type: none"> • In cases of RC-EX3A Menu → Service setting → IU settings → Select IU • In cases of RC-E5 Return address No. to “IU ...” using [▲] or [▼] button.

Note:

Error code Remote control: E16	LED	Green	Red	Content Indoor fan motor anomaly
	Indoor	Keeps flashing	1-time flash	

1. Applicable model
All models

2. Error detection method
Detected by rotation speed of indoor fan motor

3. Condition of error displayed
<ul style="list-style-type: none"> When actual rotation speed of indoor fan motor drops to lower than 200min^{-1} for 30 seconds continuously, the compressor and the indoor fan motor stop. After 2-seconds, it starts again automatically, but if this error occurs 4 times within 60 minutes after the initial detection.

4. Presumable cause
<ul style="list-style-type: none"> Defective indoor unit control PCB Foreign material at rotational area of fan propeller Defective fan motor Dust on indoor unit control PCB Blown fuse External noise, surge

5. Troubleshooting	
Diagnosis	Countermeasure
<pre> graph TD D1{Does any foreign material intervene in rotational area of fan propeller?} -- YES --> C1[Remove foreign material.] D1 -- NO --> D2{Does the fan rotate smoothly when turned by hand?} D2 -- NO --> C2[Replace the fan motor.] D2 -- YES --> D3{Is DC280V detected between ①-④ of fan motor connector CNM?} Note1["(1) ④ for GND"] -.-> D3 D3 -- YES --> D4{Is the fuse F1 or F2 blown?} D3 -- NO --> C3[Check power voltage.] D4 -- YES --> C4[Replace faulty fan motor and indoor unit control PCB.] D4 -- NO --> C3 C3 --> P1[Power source reset] P1 --> D5{Is it normalized?} D5 -- YES --> C5[Malfunction by temporary noise.] D5 -- NO --> C6[Replace fan motor. (If the error persists after replacing the fan motor, replace the indoor unit control PCB.)] </pre>	

Note:

Error code Remote control: E19	LED	Green	Red	Content Indoor unit operation check, drain pump moter check setting error
	Indoor	Keeps flashing	1-time flash	

1.Applicable model	5.Troubleshooting		
All models	Diagnosis	Countermeasure	
2.Error detection method	<pre> graph TD Start[E19 occurs when the power ON] --> Decision{Is SW7-1 on the indoor unit control PCB ON?} Decision -- NO --> Countermeasure1[Defective indoor unit control PCB (Defective SW7) -> Replace.] Decision -- YES --> Countermeasure2[Turn SW7-1 on the indoor unit control PCB OFF and reset the power.] </pre>		
After indoor operation check, when the communication between indoor and outdoor unit is established and SW7-1 is still kept ON.			
3.Condition of error displayed			
Same as above			
4.Presumable cause			
Mistake in SW7-1 setting (Due to forgetting to turn OFF SW7-1 after indoor operation check)			

Note:

Error code Remote control: E20	LED	Green	Red	Content Indoor fan motor rotation speed anomaly
	Indoor	Keeps flashing	1-time flash	

1. Applicable model
All models

2. Error detection method
Detected by rotation speed of indoor fan motor

3. Condition of error displayed
When the actual fan rotation speed does not reach to the speed of [required speed -50 min⁻¹] after 2 minutes have been elapsed since the fan motor rotation speed command was output, the unit stops by detecting indoor fan motor anomaly.

- 4. Presumable cause**
- Defective indoor unit control PCB
 - Foreign material at rotational area of fan propeller
 - Defective fan motor
 - Dust on indoor unit control PCB
 - Blown fuse
 - External noise, surge

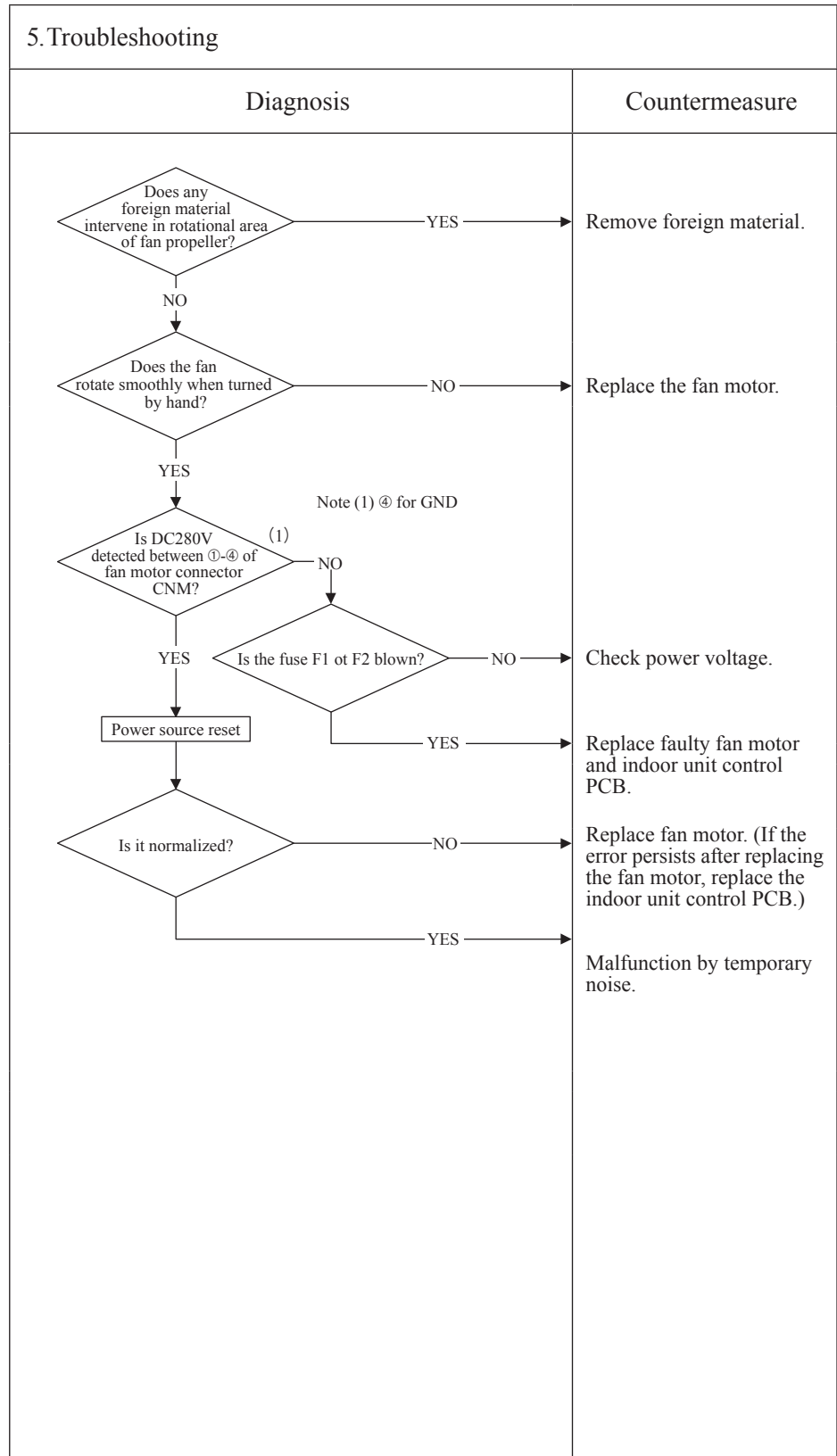

Note:

<table border="1"> <tr> <td>Error code</td> <td>LED</td> <td>Green</td> <td>Red</td> <td>Content</td> </tr> <tr> <td>Remote control: E21</td> <td>Indoor</td> <td>Keeps flashing</td> <td>1-time flash</td> <td rowspan="2">Defective panel switch operation</td> </tr> </table>	Error code	LED	Green	Red	Content	Remote control: E21	Indoor	Keeps flashing	1-time flash	Defective panel switch operation
Error code	LED	Green	Red	Content						
Remote control: E21	Indoor	Keeps flashing	1-time flash	Defective panel switch operation						

1. Applicable model
All models

2. Error detection method
Panel switch (PS) has detected Open for more than 1 second.

3. Condition of Error displayed
Same as above

4. Presumable cause
<ul style="list-style-type: none"> • Defective panel switch • Disconnection of wiring • Defective indoor unit control PCB

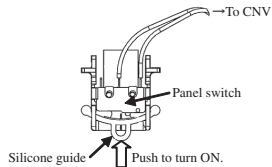
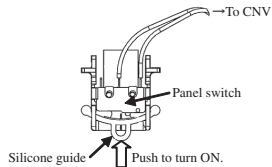
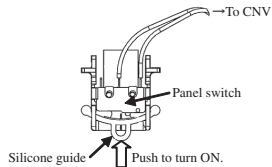
5. Troubleshooting				
<table border="1"> <thead> <tr> <th>Diagnosis</th> <th>Countermeasure</th> </tr> </thead> <tbody> <tr> <td> <p>Is grill opened?</p> <p>NO</p> <p>Does matter improve if panel switch is turned ON forcibly after resetting error?</p> <p>NO</p> <p>Are connectors at right inserted properly?</p> <p>NO</p> <p>YES</p> <p>Is there continuity between #1 - #4 of CNV on indoor unit control PCB when panel switch operation is checked?</p> </td> <td> <p>Reset the error and close the grill.</p> <p>Insufficient push on the panel switch at the internal face of grill → Attach 3 mm thick rubber sheet at the section where the panel switch touches the inside of grill. Close then the grill.</p> <p>Disconnected, poorly connected connectors → Reinsert properly.</p>  <p>• Defective panel switch or incorrect panel switch wiring → Replace panel switch.</p> <p>• Broken wire between panel switch PCB (CNV) → Correct or replace wire.</p> <p>Defective indoor unit control PCB → Replace indoor unit control PCB.</p> </td> </tr> </tbody> </table>	Diagnosis	Countermeasure	<p>Is grill opened?</p> <p>NO</p> <p>Does matter improve if panel switch is turned ON forcibly after resetting error?</p> <p>NO</p> <p>Are connectors at right inserted properly?</p> <p>NO</p> <p>YES</p> <p>Is there continuity between #1 - #4 of CNV on indoor unit control PCB when panel switch operation is checked?</p>	<p>Reset the error and close the grill.</p> <p>Insufficient push on the panel switch at the internal face of grill → Attach 3 mm thick rubber sheet at the section where the panel switch touches the inside of grill. Close then the grill.</p> <p>Disconnected, poorly connected connectors → Reinsert properly.</p>  <p>• Defective panel switch or incorrect panel switch wiring → Replace panel switch.</p> <p>• Broken wire between panel switch PCB (CNV) → Correct or replace wire.</p> <p>Defective indoor unit control PCB → Replace indoor unit control PCB.</p>
Diagnosis	Countermeasure			
<p>Is grill opened?</p> <p>NO</p> <p>Does matter improve if panel switch is turned ON forcibly after resetting error?</p> <p>NO</p> <p>Are connectors at right inserted properly?</p> <p>NO</p> <p>YES</p> <p>Is there continuity between #1 - #4 of CNV on indoor unit control PCB when panel switch operation is checked?</p>	<p>Reset the error and close the grill.</p> <p>Insufficient push on the panel switch at the internal face of grill → Attach 3 mm thick rubber sheet at the section where the panel switch touches the inside of grill. Close then the grill.</p> <p>Disconnected, poorly connected connectors → Reinsert properly.</p>  <p>• Defective panel switch or incorrect panel switch wiring → Replace panel switch.</p> <p>• Broken wire between panel switch PCB (CNV) → Correct or replace wire.</p> <p>Defective indoor unit control PCB → Replace indoor unit control PCB.</p>			

Note:

Error code Remote control: E28	LED	Green	Red	Content Remote control temperature sensor anomaly
	Indoor	Keeps flashing	Stays OFF	

1. Applicable model
All models

2. Error detection method
Detection of anomalously low temperature (resistance) of remote control temperature sensor (The)

3. Condition of error displayed
When the temperature sensor detects -50°C or lower for 5 seconds continuously, the compressor stops. After 3-minute delay, the compressor starts again automatically, but if this error occurs again within 60 minutes after the initial detection.

4. Presumable cause

- Faulty connection of remote control temperature sensor
- Defective remote control temperature sensor
- Defective remote control PCB

5. Troubleshooting

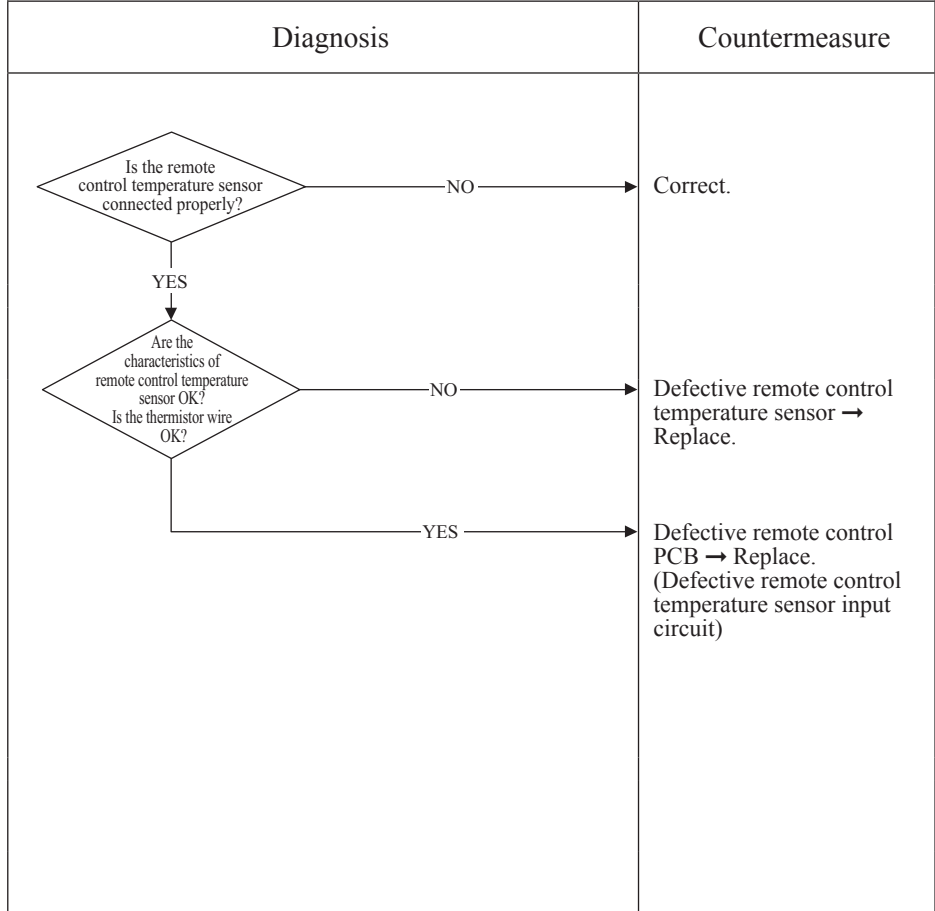

Resistance-temperature characteristics of remote control temperature sensor (The)

Temperature (°C)	Resistance value (kΩ)	Temperature (°C)	Resistance value (kΩ)
0	65	30	16
1	62	32	15
2	59	34	14
4	53	36	13
6	48	38	12
8	44	40	11
10	40	42	9.9
12	36	44	9.2
14	33	46	8.5
16	30	48	7.8
18	27	50	7.3
20	25	52	6.7
22	23	54	6.3
24	21	56	5.8
26	19	58	5.4
28	18	60	5.0

Note: After 10 seconds has passed since remote control temperature sensor was switched from valid to invalid, E28 will not be displayed even if the sensor harness is disconnected. At same time the sensor, which is effective, is switched from remote control temperature sensor to indoor return air temperature sensor. Even though the remote control temperature sensor is set to be Effective, the return air temperature displayed on remote control for checking still shows the value detected by indoor return air temperature sensor, not by remote control temperature sensor.

Error code Remote control: E35	LED	Green	Red	Content Cooling overload operation
	Indoor	Keeps flashing	Stays OFF	

Note (1) This LED is installed on models SRC40-60 only.

<p>1. Applicable model</p> <p>All models</p>	<p>5. Troubleshooting</p> <table border="1" style="width: 100%;"> <thead> <tr> <th style="width: 70%;">Diagnosis</th> <th style="width: 30%;">Countermeasure</th> </tr> </thead> <tbody> <tr> <td style="text-align: center;"> <p>* For the characteristics of outdoor heat exchanger temperature sensor, refer to E37.</p> </td> <td></td> </tr> </tbody> </table> <p>* For the contents of control, refer to the protective control by controlling compressor rotation speed and cooling high pressure protective control of microcomputer control function for corresponding models.</p>	Diagnosis	Countermeasure	<p>* For the characteristics of outdoor heat exchanger temperature sensor, refer to E37.</p>	
Diagnosis	Countermeasure				
<p>* For the characteristics of outdoor heat exchanger temperature sensor, refer to E37.</p>					
<p>2. Error detection method</p> <p>Outdoor heat exchanger temperature (°C) Note(1) Values in () are applicable when outdoor temperature (TH2) is lower than 32°C</p>					
<p>3. Condition of error displayed</p> <p>When anomalous outdoor heat exchanger temperature occurs 5 times within 60 minutes or 63(56)°C or higher continues for 10 minutes, including the compressor stop.</p>					
<p>4. Presumable cause</p> <ul style="list-style-type: none"> • Defective outdoor heat exchanger temperature sensor • Defective outdoor unit PCB • Indoor, outdoor unit installation spaces • Short-circuit of air on indoor, outdoor units • Fouling, clogging of heat exchanger • Excessive refrigerant quantity 					

Note:

Error code Remote control: E36	LED	Green	Red	Content Discharge pipe temperature error
	Indoor	Keeps flashing	Stays OFF	

1. Applicable model
All models
2. Error detection method
For the error detection method, refer to the protective control by controlling compressor rotation speed and cooling high pressure protective control of micro-computer control function for corresponding models.
3. Condition of error displayed
When discharge pipe temperature anomaly is detected 2 times within 60 minutes or this anomalous state is detected 60 minutes continuously including compressor stop.
4. Presumable cause
<ul style="list-style-type: none"> • Defective outdoor unit PCB • Defective discharge pipe temperature sensor • Clogged filter • Indoor, outdoor unit installation spaces • Short-circuit of air on indoor, outdoor units • Fouling, clogging of heat exchanger

5. Troubleshooting	
Diagnosis	Countermeasure
<p style="text-align: right;">* For the characteristics of discharge pipe temperature, refer to E39.</p> <pre> graph TD D1{Are the characteristics of discharge pipe temperature sensor normal?} -- NO --> C1[Replace discharge pipe temperature sensor.] D1 -- YES --> D2{Is the discharge pipe temperature error persisted during cooling operation?} D2 -- YES --> C2[Insufficient refrigerant amount : Recharge refrigerant by weighing proper amount on a scale.] D2 -- NO --> D3{Is the discharge pipe temperature control normal?} D3 -- NO --> C3[Control operation check *.] D3 -- YES --> D4{Is the temperature (measured actually) at detection of error correct?} D4 -- NO --> C4[Defective outdoor unit PCB -> Replace.] D4 -- YES --> C5[Check unit side: • Isn't filter clogged? • Are adequate indoor, outdoor unit installation spaces? • Isn't there any short-circuit of air? • Isn't there any fouling, clogging on indoor heat exchanger?] </pre> <p>* For the contents of control, refer to the protective control by controlling compressor rotation speed and cooling high pressure protective control of microcomputer control function for corresponding models.</p>	

Note:

Error code Remote control: E37	LED	Green	Red	Content Outdoor heat exchanger temperature sensor anomaly
	Indoor	Keeps flashing	Stays OFF	

1.Applicable model
All models

2.Error detection method
Detection of anomalously low temperature (resistance) on the outdoor heat exchanger temperature sensor

3.Condition of error displayed
<ul style="list-style-type: none"> When the temperature sensor detects -55°C or lower for 20 seconds continuously within 2 minutes to 2 minutes 20 seconds after the compressor ON, the compressor stops. After 3-minutes delay, the compressor starts again automatically, but if this anomalous temperature is detected 3 times within 40 minutes. When -55°C or lower is detected for 5 seconds continuously within 20 seconds after compressor ON.

4.Presumable cause
<ul style="list-style-type: none"> Defective outdoor unit PCB Broken sensor harness or temperature sensing section Disconnected wire connection (connector)

5.Troubleshooting																	
Diagnosis	Countermeasure																
<pre> graph TD A{Is the outdoor heat exchanger temperature sensor connector connected properly?} -- NO --> B[Correct connector.] A -- YES --> C[For the characteristics of outdoor heat exchanger temperature sensor, see the following graph.] C --> D{Are the characteristics of outdoor heat exchanger temperature sensor OK?} D -- NO --> E[Defective outdoor heat exchanger temperature sensor → Replace.] D -- YES --> F[Defective outdoor unit PCB → Replace. (Defective outdoor heat exchanger temperature sensor input circuit)] </pre>																	
<p style="text-align: center;">Temperature-resistance characteristics</p> <table border="1"> <caption>Temperature-resistance characteristics data points (approximate)</caption> <thead> <tr> <th>Temperature (°C)</th> <th>Temperature sensor resistance (kΩ)</th> </tr> </thead> <tbody> <tr> <td>0</td> <td>15</td> </tr> <tr> <td>10</td> <td>10</td> </tr> <tr> <td>20</td> <td>7</td> </tr> <tr> <td>25</td> <td>5</td> </tr> <tr> <td>30</td> <td>4</td> </tr> <tr> <td>40</td> <td>3</td> </tr> <tr> <td>50</td> <td>2</td> </tr> </tbody> </table>		Temperature (°C)	Temperature sensor resistance (kΩ)	0	15	10	10	20	7	25	5	30	4	40	3	50	2
Temperature (°C)	Temperature sensor resistance (kΩ)																
0	15																
10	10																
20	7																
25	5																
30	4																
40	3																
50	2																

Note:

Error code Remote control: E38	LED	Green	Red	Content Outdoor air temperature sensor anomaly
	Indoor	Keeps flashing	Stays OFF	

1. Applicable model All models
--

2. Error detection method Detection of anomalously low temperature (resistance) on outdoor air temperature sensor

3. Condition of error displayed <ul style="list-style-type: none"> When the temperature sensor detects -55°C or lower for 5 seconds continuously within 2 minutes to 2 minutes 20 seconds after the compressor ON, the compressor stops. After 3-minutes delay, the compressor starts again automatically, but if this anomalous temperature is detected 3 times within 40 minutes. When -55°C or lower is detected for 5 seconds continuously within 20 seconds after compressor ON.

4. Presumable cause <ul style="list-style-type: none"> Defective outdoor unit PCB Broken sensor harness or temperature sensing section (Check molding.) Disconnected wire connection (connector)

5. Troubleshooting																	
Diagnosis	Countermeasure																
<pre> graph TD Q1{Is the outdoor air temperature sensor connector connected properly?} -- NO --> C1[Correct connector.] Q1 -- YES --> Q2{Is the characteristics of the outdoor air temperature sensor OK?} Q2 -- NO --> C2[Defective outdoor air temperature sensor → Replace.] Q2 -- YES --> C3[Defective outdoor unit PCB → Replace. (Defective outdoor air temperature sensor input circuit)] </pre>																	
<p style="text-align: center;">Temperature-resistance characteristics</p> <table border="1"> <caption>Temperature-resistance characteristics</caption> <thead> <tr> <th>Temperature (°C)</th> <th>Temperature sensor resistance (kΩ)</th> </tr> </thead> <tbody> <tr> <td>0</td> <td>~16</td> </tr> <tr> <td>10</td> <td>~11</td> </tr> <tr> <td>20</td> <td>~7</td> </tr> <tr> <td>25</td> <td>5</td> </tr> <tr> <td>30</td> <td>~4</td> </tr> <tr> <td>40</td> <td>~3</td> </tr> <tr> <td>50</td> <td>~2</td> </tr> </tbody> </table>		Temperature (°C)	Temperature sensor resistance (kΩ)	0	~16	10	~11	20	~7	25	5	30	~4	40	~3	50	~2
Temperature (°C)	Temperature sensor resistance (kΩ)																
0	~16																
10	~11																
20	~7																
25	5																
30	~4																
40	~3																
50	~2																

Note:

Error code Remote control: E39	LED	Green	Red	Content Discharge pipe temperature sensor anomaly
	Indoor	Keeps flashing	Stays OFF	

1.Applicable model
All models

2.Error detection method
Detection of anomalously low temperature (resistance) on the discharge pipe temperature sensor

3.Condition of error displayed
When the temperature sensor detects -25°C or lower for 5 seconds continuously within 10 minutes to 10 minutes 20 seconds after the compressor ON, the compressor stops. After 3-minute delay, the compressor starts again automatically, but if this anomalous temperature is detected 3 times within 40 minutes.

- 4.Presumable cause**
- Defective outdoor unit PCB
 - Broken sensor harness or temperature sensing section (Check molding.)
 - Disconnected wire connection (connector)

5.Troubleshooting

Diagnosis	Countermeasure
<p>Is the discharge pipe temperature sensor connector connected properly?</p> <p>NO →</p> <p>YES →</p> <p>Are the characteristics of discharge pipe temperature sensor OK? For the characteristics of discharge pipe temperature sensor, see the following graph.</p> <p>NO →</p> <p>YES →</p>	<p>Correct connector.</p> <p>Defective discharge pipe temperature sensor → Replace.</p> <p>Defective outdoor unit PCB → Replace. (Defective temperature sensor input circuit)</p>

Temperature-resistance characteristics

(Broken wire) [T ≤ 90°C] (Short-circuit)

Temperature (°C)	Temperature sensor resistance (kΩ)
0	100
20	75
40	50
60	35
80	25
100	18
120	12
140	8

Note:

Error code Remote control: E40	LED	Green	Red	Content Service valve (gas side) closing operation
	Indoor	Keeps flashing	Stays OFF	

1. Applicable model
All models

2. Error detection method
If the inverter output current value exceeds the setting value within 80 seconds after the compressor ON in the heating mode, the compressor stops.

3. Condition of error displayed
<ul style="list-style-type: none"> • If the output current of inverter exceeds the specifications, it makes the compressor stopping. (In heating mode) • After 3-minute delay, the compressor restarts, but if this anomaly occurs 2 times within 20 minutes after the initial detection.

4. Presumable cause
<ul style="list-style-type: none"> • Service valve (gas side) closing • Defective outdoor unit PCB

5. Troubleshooting	
Diagnosis	Countermeasure
<pre> graph TD Q1{Are the service valve (gas side) opened?} -- NO --> C1[Open the service valve.] Q1 -- YES --> Q2{Is the checked result of power transistor module OK?} Q2 -- NO --> C2[Defective outdoor unit PCB -> Replace.] Q2 -- YES --> DashedBox subgraph DashedBox [] direction TB L1[• Is the space for installation of indoor and/or outdoor unit enough?] L2[• Is there any short-circuit of air on indoor and/or outdoor unit?] L3[• At heating, does the indoor fan motor run?] L4[• Is the filter clogged?] L5[• Is there any liquid flooding?] L6[• Is there any anomalous sound on the compressor?] end DashedBox --> Q3{After resetting power for several times does it become normal?} Q3 -- NO --> C3[Defective outdoor unit PCB -> Replace.] Q3 -- YES --> Note[Temporary noise may cause of anomaly. If noise source can be found, take countermeasure.] </pre>	

Note:

Error code Remote control: E42	LED	Green	Red	Content Current cut (1/2)
	Indoor	Keeps flashing	Stays OFF	

1. Applicable model
All models

2. Error detection method
In order to prevent from overcurrent of inverter, if the current exceeds the specifications, it makes the compressor stopping.

3. Condition of error displayed
• If the output current of inverter exceeds the specifications, it makes the compressor stopping.

4. Presumable cause

- The valves closed
- Faulty power source
- Insufficient refrigerant amount
- Faulty compressor
- Faulty power transistor module

5. Troubleshooting	
Diagnosis	Countermeasure
<pre> graph TD A{Is the Power source voltage OK?} -- NO --> B[Check power source.] A -- YES --> C{Are the service valves opened?} C -- NO --> D[Open the valves.] C -- YES --> E{Is the high pressure during operation OK?} E -- NO --> F[Check refrigerant amount and refrigerant circuit *In case of transitional increase of high pressure and/or test run, several times restarting may recover it, because liquid refrigerant (migrated) in the compressor is discharged from the compressor.] E -- YES --> G{Is the checked result of insulation resistance and resistance between terminals (1) of compressor motor OK? (1) 0.864Ω or more at 20°C} G -- NO --> H[Replace compressor.] G -- YES --> I[To next page.] </pre>	

Note:

Error code Remote control: E42	LED	Green	Red	Content Current cut (2/2)
	Indoor	Keeps flashing	Stays OFF	

<p>1.Applicable model</p> <p>All models</p>	5.Troubleshooting	
<p>2.Error detection method</p> <p>In order to prevent from overcurrent of inverter, if the current exceeds the specifications, it makes the compressor stopping.</p>	Diagnosis	Countermeasure
<p>3.Condition of error displayed</p> <ul style="list-style-type: none"> • If the output current of inverter exceeds the specifications, it makes the compressor stopping. 		
<p>4.Presumable cause</p> <ul style="list-style-type: none"> • Defective outdoor unit PCB • Faulty power source • Insufficient refrigerant amount • Faulty compressor • Faulty power transistor module 		

Note:

Error code Remote control: E47	LED	Green	Red	Content Active filter voltage error
	Indoor	Keeps flashing	Stays OFF	

1. Applicable model
All models

2. Error detection method
Error is displayed if the converter voltage exceeds target voltage (3 times within 20 minutes). Remote control may be set after 3-minute delay. Error is displayed if the converter voltage is lower than DC210V (1-time within 5 seconds after power ON)

3. Condition of error displayed
Same as above

4. Presumable cause
<ul style="list-style-type: none"> • Defective outdoor unit PCB • Dust on outdoor unit PCB • Anomalous power source

5. Troubleshooting	
Diagnosis	Countermeasure
<pre> graph TD A{Is the power source normal?} -- NO --> B[Restore normal condition.] A -- YES --> C{Is voltage within the specified range?} C -- NO --> D[Restore normal condition.] C -- YES --> E{Check soldered surfaces on the outdoor unit PCB for foreign matter like dust, fouling, etc.} E -- NO --> F[Remove foreign matter like dust, fouling, etc.] E -- YES --> G[Defective outdoor unit PCB -> Replace.] </pre>	
<p>• If the overvoltage (DC voltage is higher than 400V) occurs, Red LED flashes 1-time.</p>	

Note:

Error code Remote control: E48	LED	Green	Red	Content Outdoor fan motor anomaly
	Indoor	Keeps flashing	Stays OFF	

1. Applicable model
All models

2. Error detection method
Detected by rotation speed of outdoor fan motor

3. Condition of error displayed
When actual rotation speed of outdoor fan motor drops to 75min ⁻¹ or lower for 30 minutes continuously, the compressor and the outdoor fan motor stop. After 3-minute delay, it starts again automatically, but if this anomaly occurs 3 times within 60 minutes after the initial detection.

4. Presumable cause
<ul style="list-style-type: none"> • Defective outdoor unit PCB • Foreign material at rotational area of fan propeller • Defective fan motor • Dust on outdoor unit PCB • Blown F3 fuse

5. Troubleshooting	
Diagnosis	Countermeasure
<pre> graph TD D1{Does any foreign material intervene in rotational area of fan propeller?} -- YES --> C1[Remove foreign matter.] D1 -- NO --> D2{Does the fan rotate smoothly when turned by hand?} D2 -- YES --> D3{Is DC308-336V detected between (CNFAN ④ (black)-⑥ (red)) of fan motor connector?} D2 -- NO --> C2[Replace fan motor. If resistance between ① (FG):blue -④(GND):black is detected 1kΩ or lower, it is faulty.] D3 -- YES --> R1[Power source reset] D3 -- NO --> D4{Is F3 (250V1A) fuse blown?} R1 --> D5{Is normal state restored?} D4 -- YES --> C3[Replace faulty fan motor and outdoor unit PCB.] D4 -- NO --> C4[Check power source voltage.] D5 -- YES --> C5[Malfunction by temporary noise] D5 -- NO --> C6[Replace fan motor (If anomaly persists after replacing fan motor, replace outdoor unit PCB.)] </pre>	

Note: When E48 error occurs, in almost cases F3 fuse (1A) on the outdoor unit PCB is blown. There are a lot of cases that fuse is blown and E48 occurs due to defective fan motor. And even though only the outdoor unit PCB (or fuse) is replaced, another trouble could occur. Therefore when fuse is blown, check whether the fan motor is OK or not. After confirming the fan motor normal, check by power ON. (Don't power ON without confirming the fan motor normal.)

Error code Remote control: E51	LED	Green	Red	Content Power transistor anomaly
	Indoor	Keeps flashing	Stays OFF	

<p>1. Applicable model</p> <p>All models</p>	5. Troubleshooting		
<p>2. Error detection method</p> <p>Power transistor primary current</p>	Diagnosis	Countermeasure	
<p>3. Condition of error displayed</p> <p>If the power transistor primary current exceeds the setting value for 3 seconds, the compressor stops.</p>	<pre> graph TD A{Check soldered surfaces on the outdoor unit PCB for foreign matter like dust, fouling, etc.} -- NO --> B[Remove foreign matter like dust, fouling, etc.] A -- YES --> C{Isn't F2 fuse (250V, 20A) blown?} C -- YES --> D[Replace fuse.] C -- NO --> E[Defective outdoor unit PCB -> Replace.] </pre>		<p>Remove foreign matter like dust, fouling, etc.</p> <p>Replace fuse.</p> <p>Defective outdoor unit PCB → Replace.</p>
<p>4. Presumable cause</p> <ul style="list-style-type: none"> • Outdoor unit PCB anomaly • Dust on outdoor unit PCB • Blown F2 fuse 			

Note:

Error code Remote control: E57	LED	Green	Red	Content Insufficient refrigerant amount or detection of service valve closure
	Indoor	Keeps flashing	Stays OFF	

<p>1. Applicable model</p> <p>All models</p>	<p>5. Troubleshooting</p> <table border="1" style="width: 100%;"> <thead> <tr> <th style="width: 70%;">Diagnosis</th> <th style="width: 30%;">Countermeasure</th> </tr> </thead> <tbody> <tr> <td style="text-align: center;"> <p>Is the service valve fully opened?</p> <p>NO →</p> <p>YES ↓</p> </td> <td style="vertical-align: top;"> <p>Open fully.</p> </td> </tr> <tr> <td style="text-align: center;"> <p>Are the connections of indoor heat exchanger and/or return air temperature sensor connectors OK?</p> <p>NO →</p> <p>YES ↓</p> </td> <td style="vertical-align: top;"> <p>Correct indoor heat exchanger, return air temperature sensor connector connections.</p> </td> </tr> <tr> <td style="text-align: center;"> <p>Are the characteristics of indoor heat exchanger and/or return air temperature sensor OK?</p> <p>NO →</p> <p>YES ↓</p> </td> <td style="vertical-align: top;"> <p>Defective indoor heat exchanger, return air temperature sensor → Replace.</p> </td> </tr> <tr> <td style="text-align: center;"> <p>Is the low pressure during operation normal?</p> <p>NO →</p> <p>YES →</p> </td> <td style="vertical-align: top;"> <p>Charge refrigerant.</p> <p>Defective indoor unit control PCB → Replace. (Defective indoor heat exchanger, return air temperature sensor input circuits)</p> </td> </tr> </tbody> </table> <p style="text-align: center;">Indoor heat exchanger, return air temperature sensor Temperature-resistance characteristics</p> <p style="text-align: center;">(Broken wire)</p> <p style="text-align: center;">(Short-circuit)</p>	Diagnosis	Countermeasure	<p>Is the service valve fully opened?</p> <p>NO →</p> <p>YES ↓</p>	<p>Open fully.</p>	<p>Are the connections of indoor heat exchanger and/or return air temperature sensor connectors OK?</p> <p>NO →</p> <p>YES ↓</p>	<p>Correct indoor heat exchanger, return air temperature sensor connector connections.</p>	<p>Are the characteristics of indoor heat exchanger and/or return air temperature sensor OK?</p> <p>NO →</p> <p>YES ↓</p>	<p>Defective indoor heat exchanger, return air temperature sensor → Replace.</p>	<p>Is the low pressure during operation normal?</p> <p>NO →</p> <p>YES →</p>	<p>Charge refrigerant.</p> <p>Defective indoor unit control PCB → Replace. (Defective indoor heat exchanger, return air temperature sensor input circuits)</p>
Diagnosis	Countermeasure										
<p>Is the service valve fully opened?</p> <p>NO →</p> <p>YES ↓</p>	<p>Open fully.</p>										
<p>Are the connections of indoor heat exchanger and/or return air temperature sensor connectors OK?</p> <p>NO →</p> <p>YES ↓</p>	<p>Correct indoor heat exchanger, return air temperature sensor connector connections.</p>										
<p>Are the characteristics of indoor heat exchanger and/or return air temperature sensor OK?</p> <p>NO →</p> <p>YES ↓</p>	<p>Defective indoor heat exchanger, return air temperature sensor → Replace.</p>										
<p>Is the low pressure during operation normal?</p> <p>NO →</p> <p>YES →</p>	<p>Charge refrigerant.</p> <p>Defective indoor unit control PCB → Replace. (Defective indoor heat exchanger, return air temperature sensor input circuits)</p>										
<p>2. Error detection method</p> <ul style="list-style-type: none"> Judge insufficient refrigerant amount by detecting the temperature difference between indoor heat exchanger (Thi-R) and indoor return air (Thi-A). 											
<p>3. Condition of error displayed</p> <p>When the insufficient refrigerant amount is detected 3 times within 60 minutes.</p>											
<p>4. Presumable cause</p> <ul style="list-style-type: none"> Defective indoor heat exchanger temperature sensor Defective indoor return air temperature sensor Defective indoor unit control PCB Insufficient refrigerant amount 											

Note: When the compressor speed is 50 rps or under at 5 minutes after the start of compressor or the completion of defrost operation, the low refrigerant protection control judges, by detecting the difference between the indoor heat exchanger temperature (Thi-R) and the indoor return air temperature (Thi-A), that it is in the state of gas leakage, and stops the compressor.
 Cooling: Indoor return air temperature (Thi-A) – Indoor heat exchanger temperature (Thi-R) ≥ 4 deg C
 Heating: Indoor heat exchanger temperature (Thi-R) – Indoor return air temperature (Thi-A) ≤ 6 deg C

Error code Remote control: E58	LED	Green	Red	Content Current safe stop
	Indoor	Keeps flashing	Stays OFF	

1. Applicable model
All models

2. Error detection method
When the current safe control has operated at the compressor speed of 30 rps or under:

3. Condition of error displayed
Same as above

4. Presumable cause
<ul style="list-style-type: none"> • Excessive refrigerant amount • Indoor, outdoor unit installation spaces • Faulty compressor • Defective outdoor air temperature sensor • Defective outdoor unit PCB

5. Troubleshooting	
Diagnosis	Countermeasure
<pre> graph TD D1{Is the refrigerant amount normal?} -- NO --> C1[Adjust the refrigerant amount properly.] D1 -- YES --> D2{Is outdoor ventilation condition good?} D2 -- NO --> C2[Secure space for inlet and outlet.] D2 -- YES --> D3{Inspect compressor} D3 -- NO --> C3[Replace compressor.] D3 -- YES --> D4{Inspect outdoor air temperature sensor} D4 -- NO --> C4[Replace sensor.] D4 -- YES --> C5[Defective outdoor unit PCB -> Replace. (Defective outdoor air temperature sensor input circuit)] </pre>	

Note:

Error code Remote control: E59	LED	Green	Red	Content Compressor startup failure
	Indoor	Keeps flashing	Stays OFF	

1.Applicable model
All models

2.Error detection method
If it fails to change over to the rotor detection operation of compressor motor

3.Condition of error displayed
If compressor fails to startup for 42 times

4.Presumable cause
<ul style="list-style-type: none"> • Outdoor fan motor anomaly • Outdoor unit PCB anomaly • Anomalous power source voltage • Improper refrigerant amount and refrigerant circuit • Faulty compressor (Motor bearing)

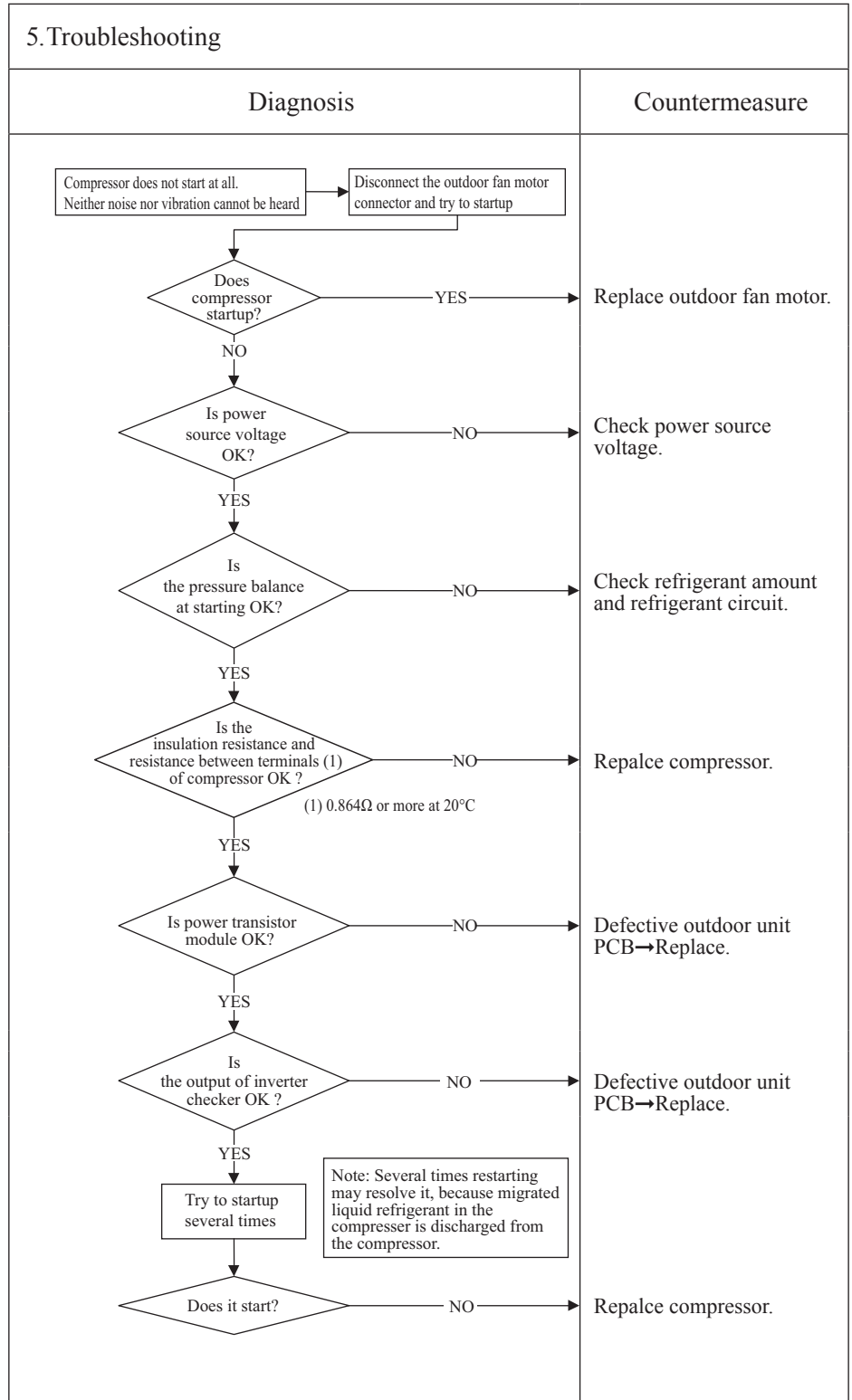

Note: Insulation resistance

- The unit is left for long period without power source or soon after installation, migrated liquid refrigerant may dissolve in the refrigerant oil in the compressor. In such case insulation resistance decreases upto several MΩ or lower. If the electric leakage breaker is activated due to low insulation resistance, check followings.
 - ① Check whether the insulation resistance can recover or not, ater 6 hours has passed since power ON.
(By energize the crankcase heater, migrated liquid refrigerant in the refrigerant oil in compressor can be evaporated)
 - ② Check whether the electric leakage breake conforms to high-hermonic specifications
(As units has inverter, in order to prevent from improper operation, be sure to use high-hermonic one.)

Error code Remote control: E60	LED	Green	Red	Content Compressor rotor lock error
	Indoor	Keeps flashing	Stays OFF	

1. Applicable model
All models
2. Error detection method
Compressor rotor position
3. Condition of error displayed
If it fails again to detect the rotor position after shifting to the compressor rotor position detection operation, the compressor stops.
4. Presumable cause
<ul style="list-style-type: none"> • Defective outdoor fan motor • Defective outdoor unit PCB • Anomalous power source voltage • Improper refrigerant amount and refrigerant circuit • Defective compressor (motor, bearing)

5. Troubleshooting	
Diagnosis	Countermeasure
<pre> graph TD Q1{Is the power source voltage OK?} -- NO --> C1[Check and correct the power source voltage.] Q1 -- YES --> R1[Reset the power source and restart operation.] R1 --> Q2{Does the compressor start?} Q2 -- NO --> Q3{Does E59 occur?} Q3 -- YES --> C2[Correct it based on the troubleshooting of E59.] Q3 -- NO --> Q4{Does the compressor run without occurrence of E42?} Q4 -- NO --> C3[Correct it based on the troubleshooting of E42.] Q2 -- YES --> Q5{Is the output from inverter checker OK?} Q5 -- NO --> C4[Defective outdoor unit PCB → Replace.] Q5 -- YES --> Q6{Is the noise or vibration of compressor normal?} Q6 -- NO --> C5[Replace compressor.] Q6 -- YES --> Q7{Does it start up normally without recurrence of E60.} Q7 -- NO --> C6[Check compressor for insulation, resistance. Replace compressor if necessary.] Q7 -- YES --> C7[Defective outdoor unit PCB → Replace.] </pre>	

Note: Insulation resistance

- The unit is left for long period without power source or soon after installation, migrated liquid refrigerant may dissolve in the refrigerant oil in the compressor. In such case insulation resistance decreases upto several MΩ or lower. If the electric leakage breaker is activated due to low insulation resistance, check followings.
 - ① Check whether the insulation resistance can recover or not, after 6 hours has passed since power ON.
(By energize the crankcase heater, migrated liquid refrigerant in the refrigerant oil in compressor can be evaporated)
 - ② Check whether the electric leakage breaker conforms to high-harmonic specifications
(As units has inverter, in order to prevent from improper operation, be sure to use high-harmonic one.)

3. ELECTRICAL WIRING

(1) Indoor units

Models FDT 40VH, 50VH, 60VH

Meaning of marks

Item	Description
AM1-4	Draft prevention function motor
CNB-Z	Connector
DM	Drain pump motor
F1,2	Fuse
FMI	Fan motor
FS	Floot switch
HS	Humidity sensor
L	Reactor
LED • 2	Indication lamp (Green-Normal operation)
LED • 3	Indication lamp (Red-Inspection)
LM1-4	Louver motor
PIS	Motion sensor
SW2	Remote control communication address
SW5	Plural units Master / Slave setting
SW6	Model capacity setting
SW7-1	Operation check, drain pump motor test run
TB1	Terminal block (Power source) (□ mark)
TB2	Terminal block (Signal line) (□ mark)
Thc	Temperature sensor (Remote control)
Thi-A	Temperature sensor (Return air)
Thi-R1,2,3	Temperature sensor (Heat exchanger)

Color marks

Mark	Color	Mark	Color
BK	Black	WH	White
BL	Blue	YE	Yellow
BR	Brown	GY	Gray
OR	Orange	YE/GN	Yellow/Green
RD	Red		

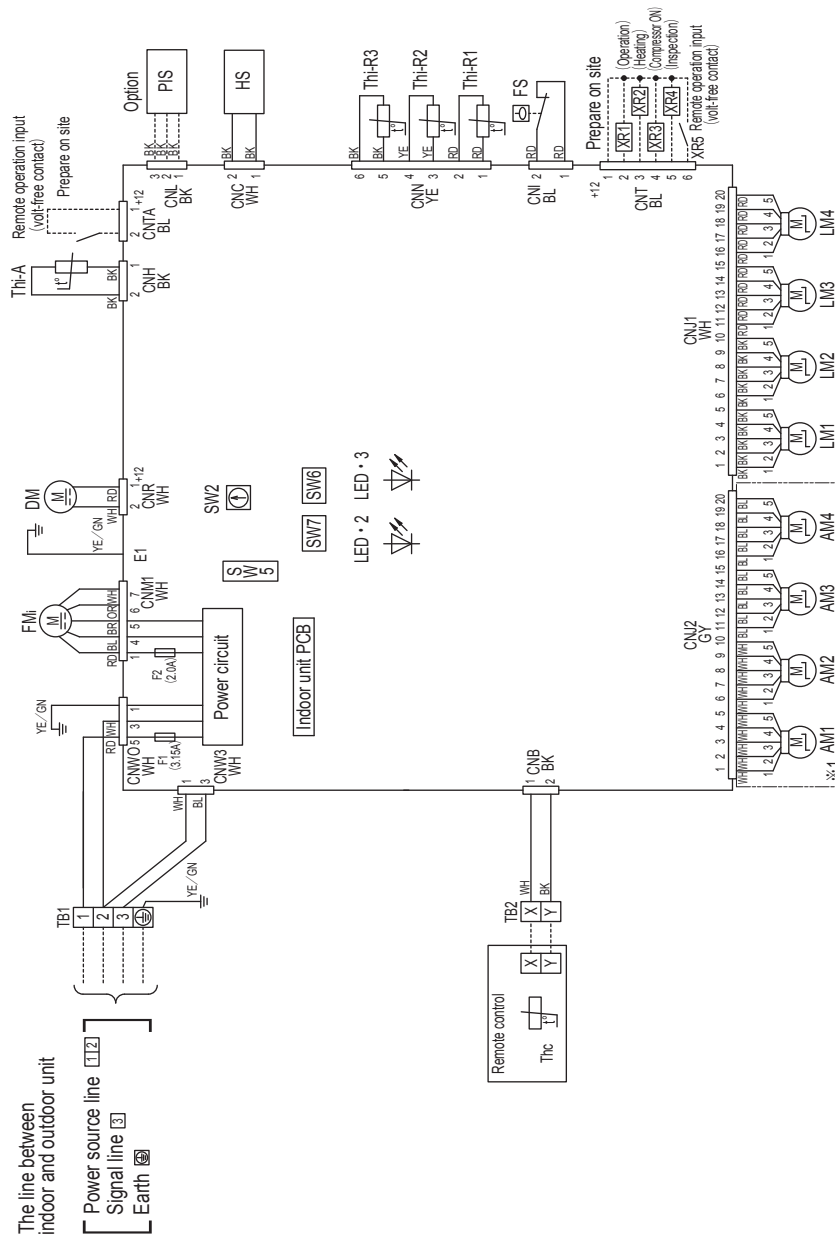

- Notes
1. ----- indicates wiring on site.
 2. See the wiring diagram of outdoor unit about the line between indoor unit and outdoor unit.
 3. Use twin core cord (0.3mm²) at remote control line.
See spec sheet of remote control in case that the total length is more than 100m.
 4. Do not put remote control line alongside power source line.
 5. Section 1 (※1) is provided on the panel T-PSAE-5AW-E only.

PJF000Z554

(2) Outdoor units

Models SRC40ZSX-S, 50ZSX-S, 60ZSX-S

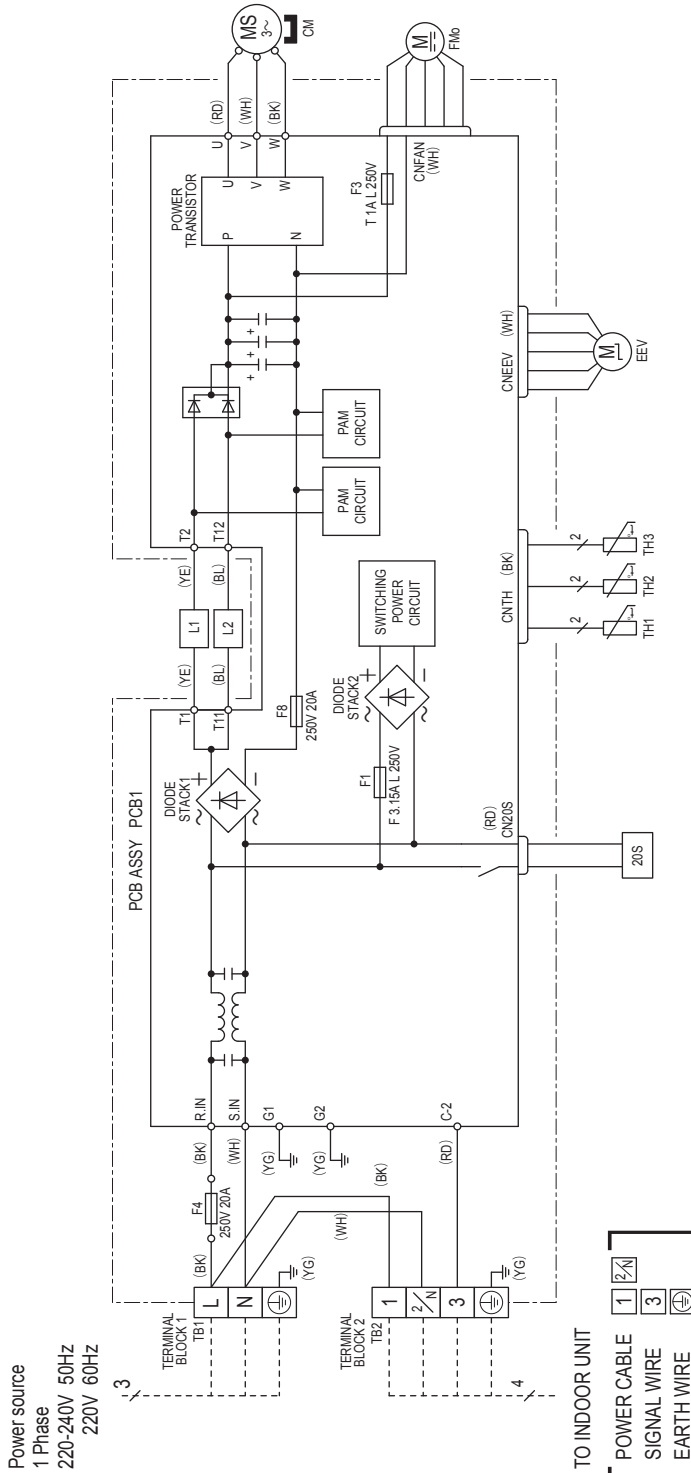

Meaning of marks

Item	Description
20S	Solenoid coil for 4-way valve
CN20S	Connector
CNEEV	Compressor motor
CNFAN	Electric expansion valve (coil)
CNTH	Fan motor
CM	Reactor
EEV	Heat exchanger sensor
FMo	Outdoor air temperature sensor
L1,2	Discharge pipe temperature sensor
TH1	
TH2	
TH3	

Color marks

Mark	Color
BK	Black
BL	Blue
RD	Red
WH	White
YE	Yellow
YG	Yellow / Green

Power cable, indoor-outdoor connecting wires

Model name	MAX running current (A)	Power cable wire size x number*	Power cable length (m)	Connecting cable wire size x number*
SRC40ZSX-S	15	2.0mm ² x 3	13	1.5mm ² x 4
SRC50ZSX-S				
SRC60ZSX-S				

* The wire numbers include earth wire (Yellow/Green).
 * Switchgear or circuit breaker capacity should be chosen according to national or regional electricity regulations.
 * The power cable specifications are based on the assumption that a metal or plastic conduit is used with no more than three cables contained in a conduit and a voltage drop is 2%. For an installation failing outside of these conditions, please follow the national or regional electricity regulations.

RWC000Z298

4. PIPING SYSTEM

Models 40, 50, 60

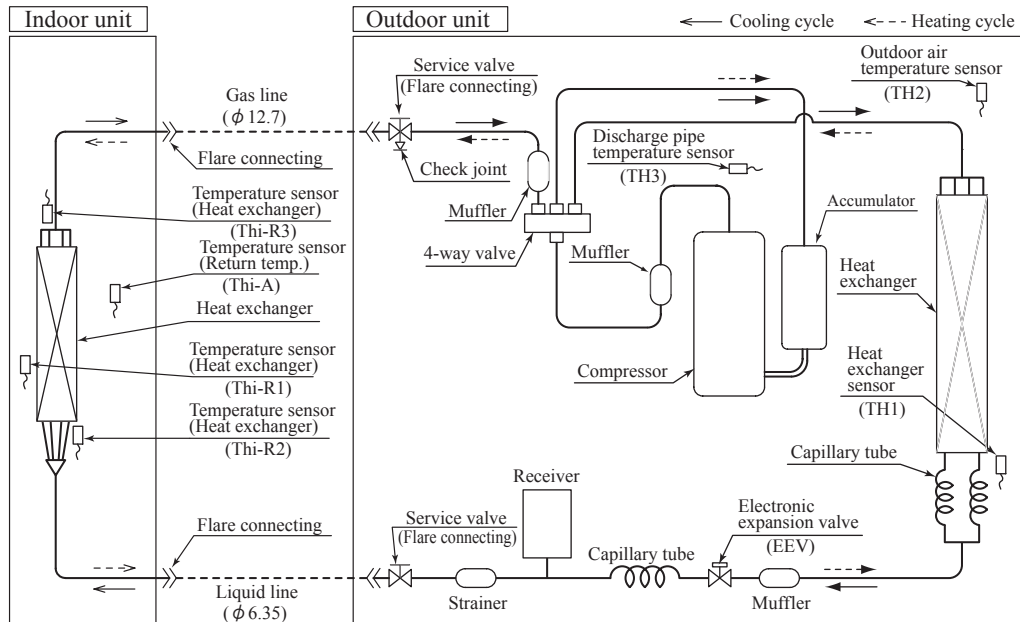

Preset point of the protective devices

Parts name	Mark	Equipped unit	40, 50, 60 model
Temperature sensor (for protection overloading in heating)	Thi-R	Indoor unit	OFF 63°C ON 56°C
	Thi-R		OFF 1.0°C ON 10°C
Temperature sensor (for protection high pressure in cooling.)	TH1	Outdoor unit	OFF 63°C ON 53°C
Temperature sensor (for detecting discharge pipe temp.)	TH3	Outdoor unit	OFF 115°C ON 95°C

HYPER INVERTER PACKAGED AIR-CONDITIONERS



MITSUBISHI HEAVY INDUSTRIES THERMAL SYSTEMS, LTD.

16-5 Konan 2-chome, Minato-ku, Tokyo, 108-8215, Japan
<http://www.mhi-mth.co.jp/en/>

Because of our policy of continuous improvement, we reserve the right to make changes in all specifications without notice.

© Copyright MITSUBISHI HEAVY INDUSTRIES THERMAL SYSTEMS, LTD.